

## High Input Voltage, Low $I_Q$ $\mu$ Cap LDO Regulator

### Features

- AEC-Q100 Qualified and PPAP Capable; Available for 5-Lead SOT23 Package Only
- Wide Input Voltage Range: 2.3V to 36V
- Ultra-Low Ground Current: 18  $\mu$ A
- Low Dropout Voltage of 270 mV at 100 mA
- High Output Accuracy of  $\pm 2.0\%$  Overtemperature
- $\mu$ Cap: Stable with Ceramic or Tantalum Capacitors
- Excellent Line and Load Regulation Specifications
- Near Zero Shutdown Current: Typical 0.1  $\mu$ A
- Reverse Battery Protection
- Reverse Leakage Protection
- Thermal Shutdown and Current Limit Protection
- 5-Lead SOT23 and 3-Lead SOT223 Packages

### Applications

- Keep-Alive Supply in Notebook and Portable Computers
- USB Power Supply
- Logic Supply for High-Voltage Batteries
- Automotive Electronics
- Battery-Powered Systems
- 3-4 Cell Li-Ion Battery Input Range

### General Description

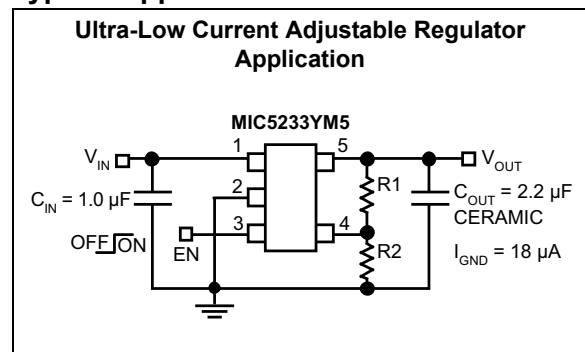
The MIC5233 is a 100 mA, highly accurate, low dropout regulator with high input voltage and ultra-low ground current. This combination of high voltage and low ground current makes the MIC5233 ideal for multicell Li-Ion battery systems.

A  $\mu$ Cap LDO design, the MIC5233 is stable with either ceramic or tantalum output capacitors. It only requires a 2.2  $\mu$ F output capacitor for stability.

Features of the MIC5233 include enable input, thermal shutdown, current limit and reverse battery protection, and reverse leakage protection.

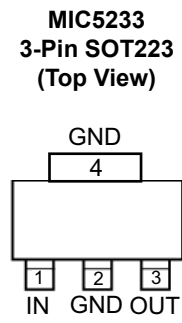
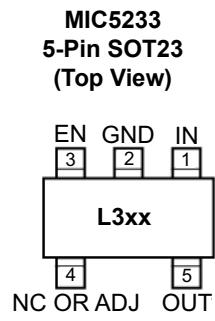
Available in fixed and adjustable output voltage versions, the MIC5233 is offered in the 5-lead SOT23 and 3-lead SOT223 packages with a junction temperature range of  $-40^\circ\text{C}$  to  $+125^\circ\text{C}$ .

### Typical Application Circuit

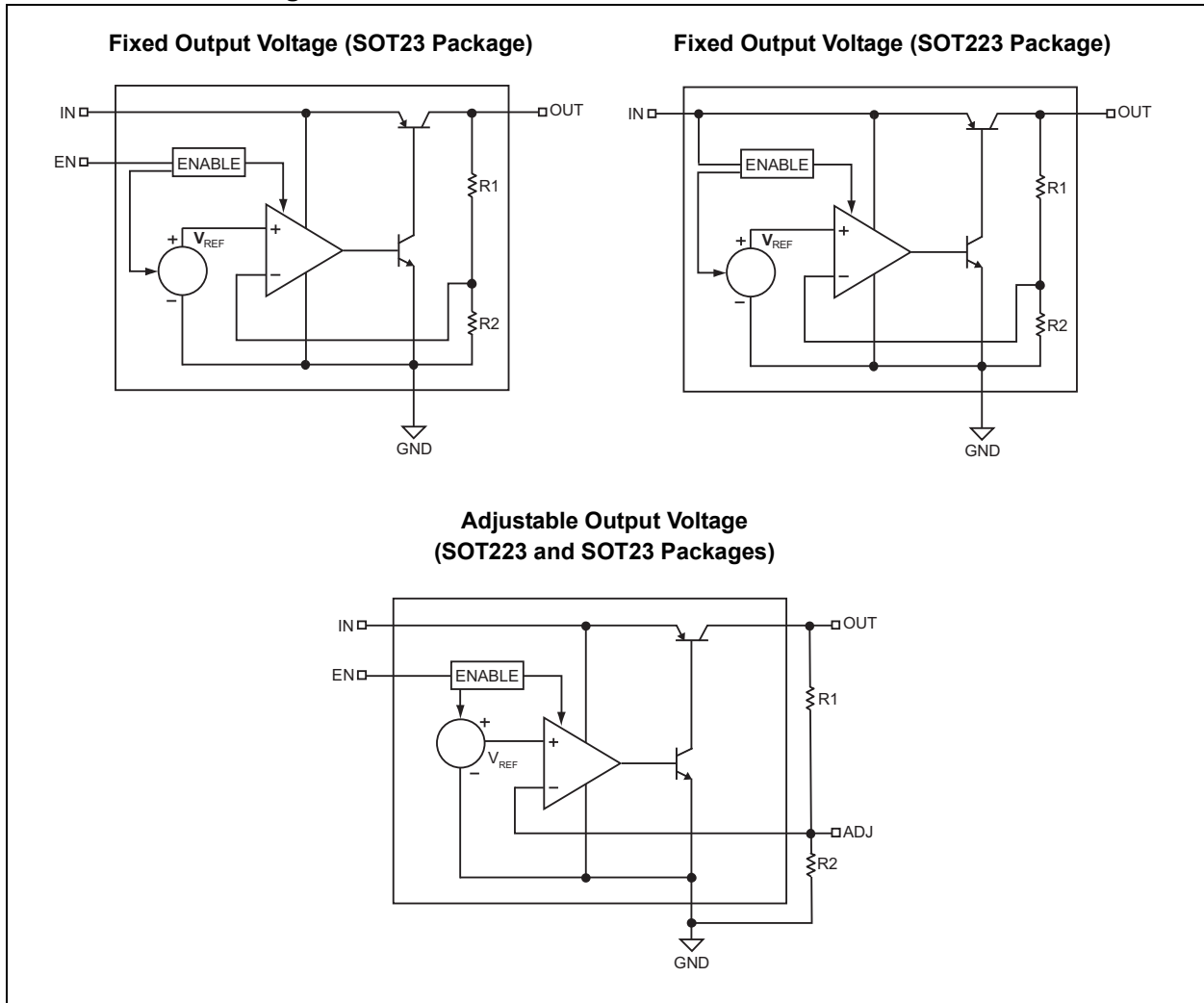


# MIC5233

## Package Types



## Functional Block Diagrams



# MIC5233

## 1.0 ELECTRICAL CHARACTERISTICS

### Absolute Maximum Ratings†

Input Supply Voltage ( $V_{IN}$ )	-20V to +38V
Enable Input Voltage ( $V_{EN}$ )	-0.3V to +38V
Power Dissipation ( $P_{DIS}$ )	Internally Limited
ESD Rating ( <b>Note 1</b> )	ESD Sensitive

### Operating Ratings‡

Input Supply Voltage ( $V_{IN}$ )	+2.3V to +36V
Enable Input Voltage ( $V_{EN}$ )	0V to +36V

† **Notice:** Stresses above those listed under “Absolute Maximum Ratings” may cause permanent damage to the device. This is a stress rating only and functional operation of the device at those or any other conditions above those indicated in the operational sections of this specification is not intended. Exposure to maximum rating conditions for extended periods may affect device reliability. Specifications are for packaged product only.

‡ The device is not ensured to function outside its operating ratings.

**Note 1:** Devices are ESD sensitive. Handling precautions are recommended.

**TABLE 1-1: ELECTRICAL CHARACTERISTICS**

<b>Electrical Characteristics:</b> $T_J = +25^\circ\text{C}$ with $V_{IN} = V_{OUT} + 1\text{V}$ ; $I_{OUT} = 100\ \mu\text{A}$ ; <b>Bold</b> values indicate $-40^\circ\text{C} \leq T_J \leq +125^\circ\text{C}$ , unless otherwise specified. Specifications for packaged product only.						
Parameter	Symbol	Min.	Typ.	Max.	Units	Conditions
Output Voltage Accuracy	$V_{OUT}$	-1.0	—	1.0	%	Variation from nominal $V_{OUT}$
		<b>-2.0</b>	—	<b>2.0</b>		
Line Regulation	$\Delta V_{OUT}/\Delta V_{IN}$	—	0.04	0.5	%	$V_{IN} = V_{OUT} + 1\text{V}$ to 36V
Load Regulation	$\Delta V_{OUT}/I_{OUT}$	—	0.25	1	%	$I_{OUT} = 100\ \mu\text{A}$ to 100 mA
Dropout Voltage	$V_{DO}$	—	50	—	mV	$I_{OUT} = 100\ \mu\text{A}$
		—	230	300		$I_{OUT} = 50\ \text{mA}$
		—	—	<b>400</b>		$I_{OUT} = 100\ \text{mA}$
		—	270	400		
		—	—	<b>450</b>		
Ground Current	$I_{GND}$	—	18	30	$\mu\text{A}$	$I_{OUT} = 100\ \mu\text{A}$
		—	—	<b>35</b>		
		—	0.25	0.70	mA	$I_{OUT} = 50\ \text{mA}$
		—	1	2		$I_{OUT} = 100\ \text{mA}$
Ground Current in Shutdown	$I_{SHDN}$	—	0.1	1	$\mu\text{A}$	$V_{EN} \leq 0.6\text{V}$ ; $V_{IN} = 36\text{V}$ (SOT23 package only)
Short-Circuit Current	$I_{SC}$	—	190	<b>350</b>	mA	$V_{OUT} = 0\text{V}$
Output Leakage, Reverse Polarity Input ( <b>Note 2</b> )	$V_{OUT}$	—	-0.1	—	V	Load = 500 $\Omega$ ; $V_{IN} = -15\text{V}$
<b>Enable Input (SOT23 Package Only)</b>						
Input Low Voltage	$V_{EN}$	—	—	0.6	V	Regulator off
Input High Voltage		2.0	—	—	V	Regulator on
Enable Input Current	$I_{EN}$	-1.0	0.01	1.0	$\mu\text{A}$	$V_{EN} = 0.6\text{V}$ ; regulator off
		—	0.1	1.0		$V_{EN} = 2.0\text{V}$ ; regulator on
		—	0.5	2.5		$V_{EN} = 36\text{V}$ ; regulator on
Start-up Time	$t_{START}$	—	1.7	<b>7</b>	ms	$V_{IN}$ applied before EN signal

**Note 1:** The maximum allowable power dissipation is a function of ambient temperature, the maximum allowable junction temperature and the thermal resistance from junction to air (i.e.,  $T_A$ ,  $T_J$ ,  $\theta_{JA}$ ). Exceeding the maximum allowable power dissipation will cause the device operating junction temperature to exceed the maximum +125°C rating. Sustained junction temperatures above +125°C can impact the device reliability.

**2:** Design guidance only, not production tested.

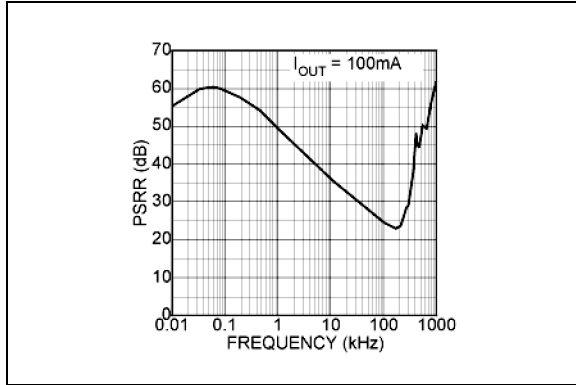
## TEMPERATURE SPECIFICATIONS<sup>(1)</sup>

Parameters	Sym.	Min.	Typ.	Max.	Units	Conditions
<b>Temperature Ranges</b>						
Junction Operating Temperature Range	$T_J$	-40	—	+125	°C	—
Storage Temperature Range	$T_S$	-65	—	+150	°C	—
<b>Package Thermal Resistances</b>						
Thermal Resistance 5-Lead SOT23	$\theta_{JA}$	—	235	—	°C/W	—
Thermal Resistance 3-Lead SOT223	$\theta_{JA}$	—	50	—	°C/W	—

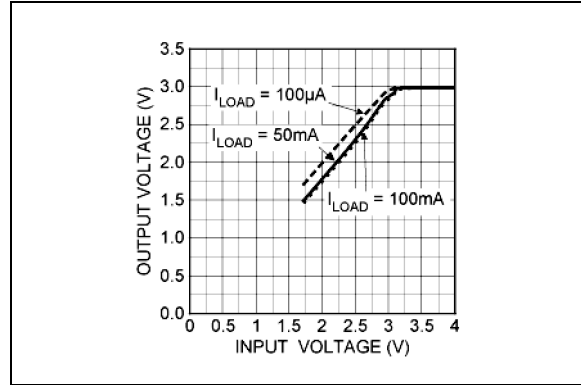
- Note 1:** The maximum allowable power dissipation is a function of ambient temperature, the maximum allowable junction temperature and the thermal resistance from junction to air (i.e.,  $T_A$ ,  $T_J$ ,  $\theta_{JA}$ ). Exceeding the maximum allowable power dissipation will cause the device operating junction temperature to exceed the maximum +125°C rating. Sustained junction temperatures above +125°C can impact the device reliability.
- 2:** Design guidance only, not production tested.

## 2.0 TYPICAL PERFORMANCE CURVES

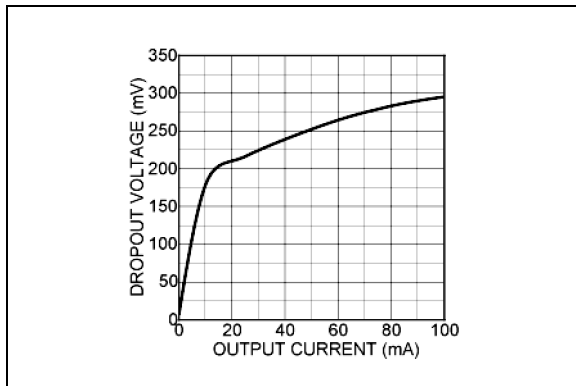
**Note:** The graphs and tables provided following this note are a statistical summary based on a limited number of samples and are provided for informational purposes only. The performance characteristics listed herein are not tested or guaranteed. In some graphs or tables, the data presented may be outside the specified operating range (e.g., outside specified power supply range) and therefore outside the warranted range.



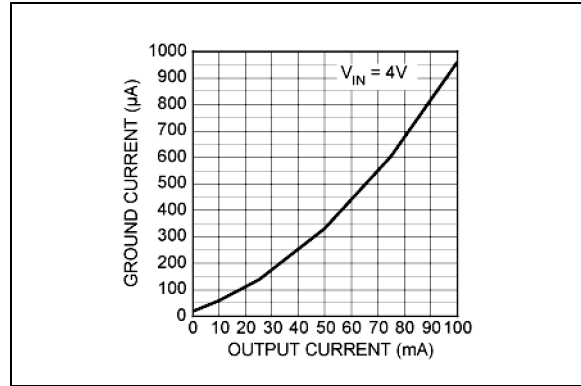
**FIGURE 2-1:** Power Supply Rejection Ratio.



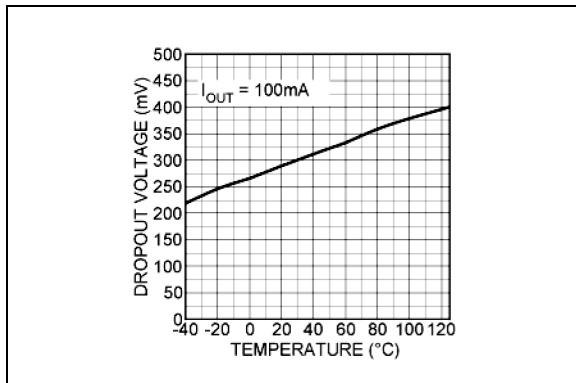
**FIGURE 2-4:** Dropout Characteristics.



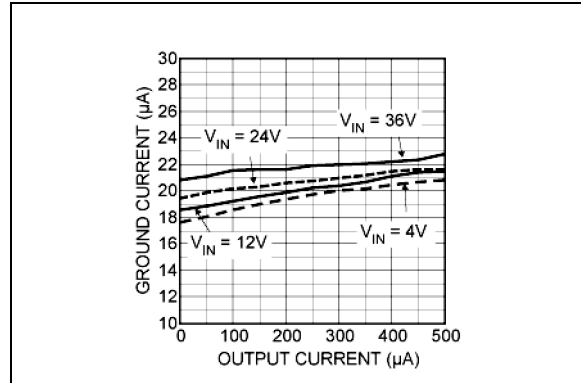
**FIGURE 2-2:** Dropout Voltage vs. Output Current.



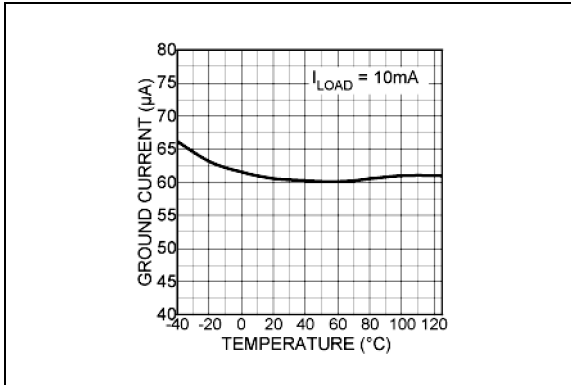
**FIGURE 2-5:** Ground Pin Current vs. Output Current.



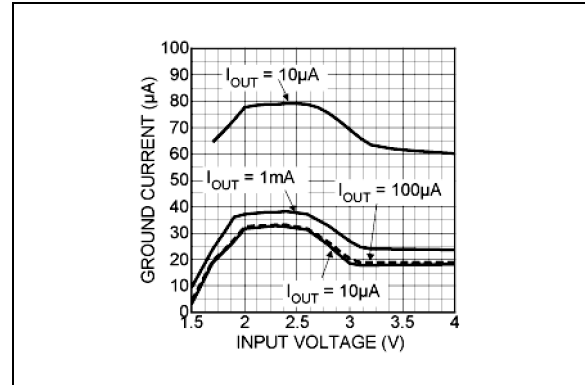
**FIGURE 2-3:** Dropout Voltage vs. Temperature.



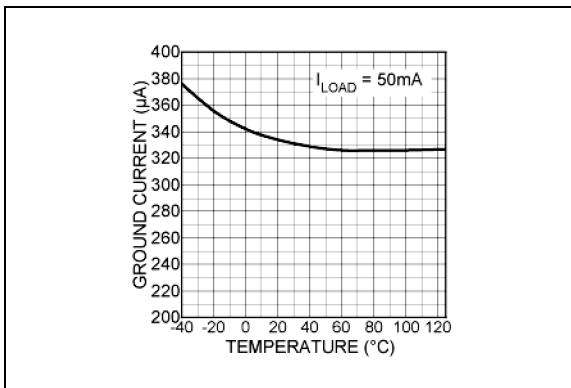
**FIGURE 2-6:** Ground Pin Current vs. Output Current.



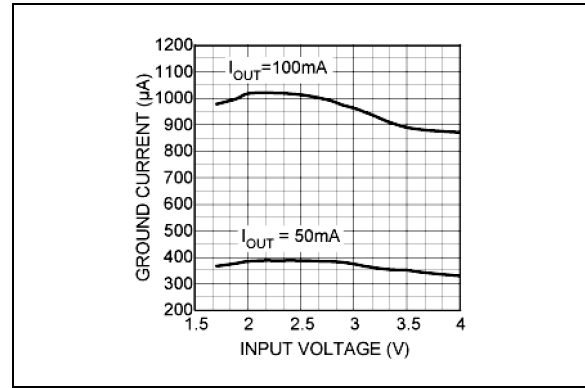
**FIGURE 2-7:** Ground Pin Current vs. Temperature.



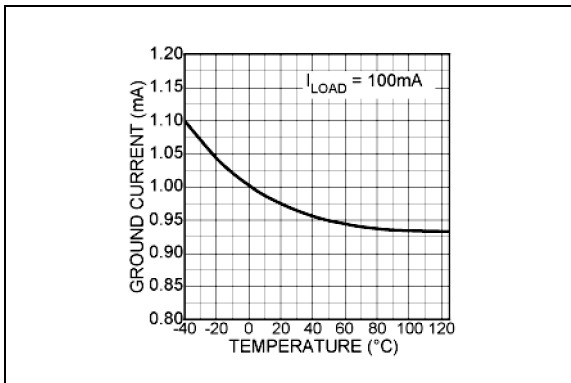
**FIGURE 2-10:** Ground Pin Current vs. Input Voltage.



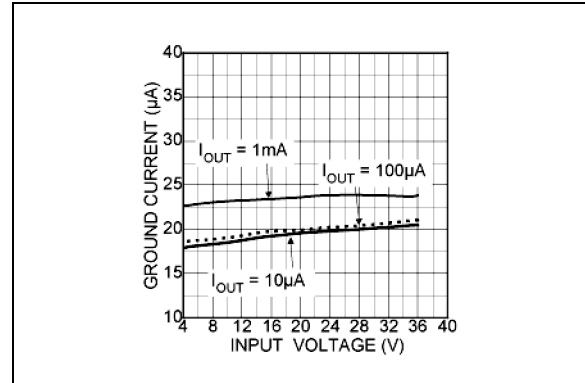
**FIGURE 2-8:** Ground Pin Current vs. Temperature.



**FIGURE 2-11:** Ground Pin Current vs. Input Voltage.

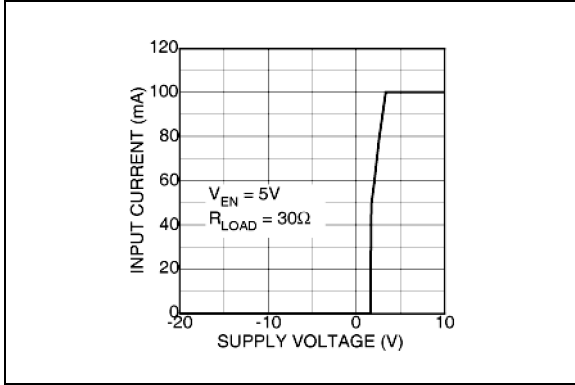


**FIGURE 2-9:** Ground Pin Current vs. Temperature.

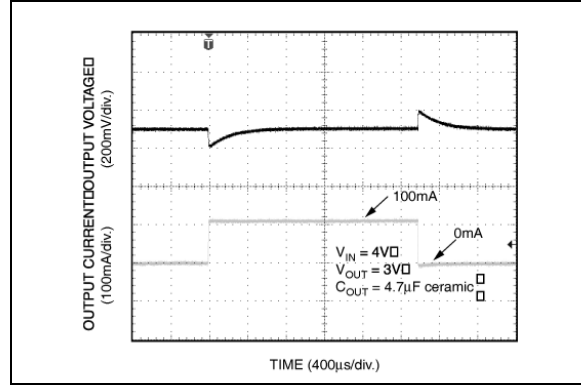


**FIGURE 2-12:** Ground Pin Current vs. Input Voltage.

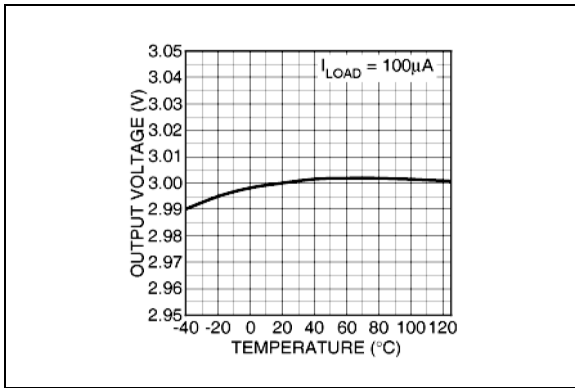
# MIC5233



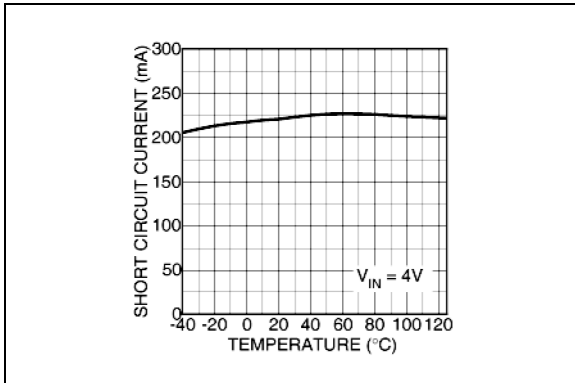
**FIGURE 2-13:** Input Current vs. Supply Voltage.



**FIGURE 2-16:** Load Transient Response.



**FIGURE 2-14:** Output Voltage vs. Temperature.



**FIGURE 2-15:** Short-Circuit Current vs. Temperature.

## 3.0 PIN DESCRIPTIONS

The descriptions of the pins are listed in [Table 3-1](#).

**TABLE 3-1: PIN FUNCTION TABLE**

Pin Number SOT223	Pin Number SOT23	Pin Name	Description
1	1	IN	Supply Input.
2	2	GND	Ground.
—	3	EN	Enable (Input). Logic Low = Shutdown; Logic High = Enable.
—	4	NC	No Connect.
		ADJ	Adjustable (Input). Feedback Input; Connect to Resistive Voltage Divider Network.
3	5	OUT	Regulator Output.
4	—	EP	Exposed Pad. Internally Connected to Ground.

## 4.0 APPLICATION INFORMATION

### 4.1 Enable/Shutdown

The MIC5233 comes with an active-high enable pin that allows the regulator to be disabled. Forcing the enable pin low disables the regulator and sends it into a “Zero” Off mode current state, consuming a typical 0.1  $\mu$ A. Forcing the enable pin high enables the output voltage.

### 4.2 Input Capacitor

The MIC5233 has a high input voltage capability, up to 36V. The input capacitor must be rated to sustain voltages that may be used on the input. An input capacitor may be required when the device is not near the source power supply or when supplied by a battery. Small surface mount, ceramic capacitors can be used for bypassing. A larger value may be required if the source supply has high ripple.

### 4.3 Output Capacitor

The MIC5233 requires an output capacitor for stability. The design requires 2.2  $\mu$ F or greater on the output to maintain stability. The design is optimized for use with low-ESR ceramic chip capacitors. High-ESR capacitors may cause high-frequency oscillation. The maximum recommended ESR is 3 $\Omega$ . The output capacitor can be increased without limit. Larger valued capacitors help to improve transient response.

X7R/X5R dielectric-type ceramic capacitors are recommended because of their temperature performance. X7R-type capacitors change capacitance by 15% over their operating temperature range and are the most stable type of ceramic capacitors. Z5U and Y5V dielectric capacitors change value by as much as 50% and 60%, respectively, over their operating temperature ranges. To use a ceramic chip capacitor with Y5V dielectric, the value must be much higher than an X7R ceramic capacitor to ensure the same minimum capacitance over the equivalent operating temperature range.

### 4.4 No-Load Stability

The MIC5233 will remain stable and in regulation with no load unlike many other voltage regulators. This is especially important in CMOS RAM keep-alive applications.

### 4.5 Thermal Consideration

The MIC5233 is designed to provide 100 mA of continuous current in a very small package. Maximum power dissipation can be calculated based on the output current and the voltage drop across the part.

To determine the maximum power dissipation of the package, use the junction-to-ambient thermal resistance of the device and [Equation 4-1](#):

#### EQUATION 4-1:

$$P_{D(MAX)} = \left( \frac{T_{J(MAX)} - T_A}{\theta_{JA}} \right)$$

Where:

$T_{J(MAX)}$  = Maximum junction temperature of the die at +125°C

$T_A$  = The ambient operating temperature

$\theta_{JA}$  = Layout dependent

[Table 4-1](#) shows examples of the junction-to-ambient thermal resistance for the MIC5233:

**TABLE 4-1: 5-LEAD SOT23 AND SOT-223 THERMAL RESISTANCE**

Package	$\theta_{JA}$ Recommended Minimum Footprint
SOT23-5	235°C/W
SOT223	50°C/W

The actual power dissipation of the regulator circuit can be determined using [Equation 4-2](#):

#### EQUATION 4-2:

$$P_D = (V_{IN} - V_{OUT})I_{OUT} + V_{IN} \times I_{GND}$$

Substituting  $P_{D(MAX)}$  for  $P_D$  and solving for the operating conditions that are critical to the application will give the maximum operating conditions for the regulator circuit. For example, when operating the MIC5233-3.0YM5 at +50°C, with a minimum footprint layout, the maximum input voltage for a set output current can be determined as follows:

#### EQUATION 4-3:

$$P_{D(MAX)} = \left( \frac{125^\circ\text{C} - 50^\circ\text{C}}{235^\circ\text{C/W}} \right)$$

Where:

$P_{D(max)} = 319 \text{ mW}$

The junction-to-ambient ( $\theta_{JA}$ ) thermal resistance for the minimum footprint is +235°C/W from [Table 4-1](#). It is important that the maximum power dissipation not be exceeded to ensure proper operation. Because the MIC5233 was designed to operate with high input voltages, careful consideration must be given so as not to overheat the device. With very high input-to-output voltage differentials, the output current is limited by the total power dissipation.

Total power dissipation is calculated using the following equation:

**EQUATION 4-4:**

$$P_D = (V_{IN} - V_{OUT})I_{OUT} + V_{IN} \times I_{GND}$$

Due to the potential for input voltages up to 36V, ground current must be taken into consideration.

If we know the maximum load current, we can solve for the maximum input voltage using the maximum power dissipation calculated for a +50°C ambient, 319 mW.

**EQUATION 4-5:**

$$P_{D(MAX)} = (V_{IN} - V_{OUT})I_{OUT} + V_{IN} \times I_{GND}$$

$$319mW = (V_{IN} - 3V)100mA + V_{IN} \times 2.8mA$$

Ground pin current is estimated using the typical characteristics of the device.

**EQUATION 4-6:**

$$619mW = V_{IN}(102.8mA)$$

Where:

$$V_{IN} = 6.02V$$

For higher current outputs, only a lower input voltage will work for higher ambient temperatures.

Assuming a lower output current of 10 mA, the maximum input voltage can be recalculated:

**EQUATION 4-7:**

$$319mW = (V_{IN} - 3V)10mA + V_{IN} \times 0.1mA$$

$$349mW = V_{IN} \times 10.1mA$$

Where:

$$V_{IN} = 34.55V$$

Maximum input voltage for a 10 mA load current at 50°C ambient temperature is 34.55V, utilizing virtually the entire operating voltage range of the device.

## 4.6 Adjustable Regulator Application

The MIC5233M5 can be adjusted from 1.24V to 20V by using two external resistors (Figure 4-1). The resistors set the output voltage based on the following equation:

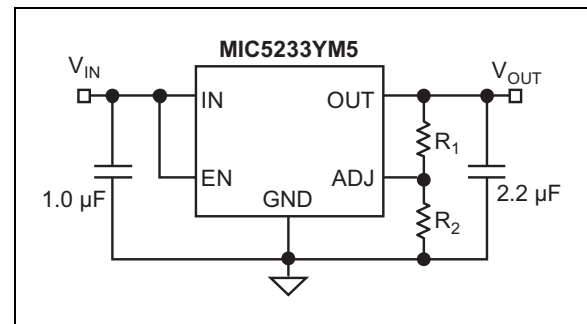
**EQUATION 4-8:**

$$V_{OUT} = V_{REF} \left( 1 + \left( \frac{R1}{R2} \right) \right)$$

Where

$$V_{REF} = 1.24V$$

Feedback resistor R2 should be no larger than 300 kΩ.



**FIGURE 4-1:** Adjustable Voltage Application.

# MIC5233

---

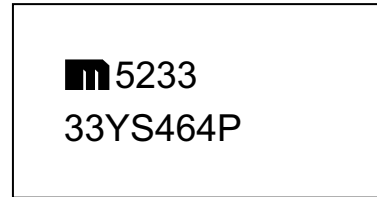
## 5.0 PACKAGING INFORMATION

### 5.1 Package Marking Information

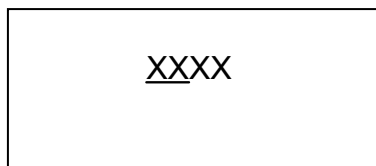
5-Lead SOT23\*



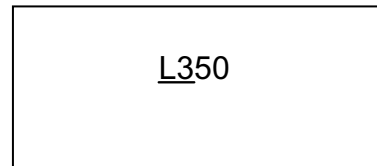
Example



3-Lead SOT223\*



Example



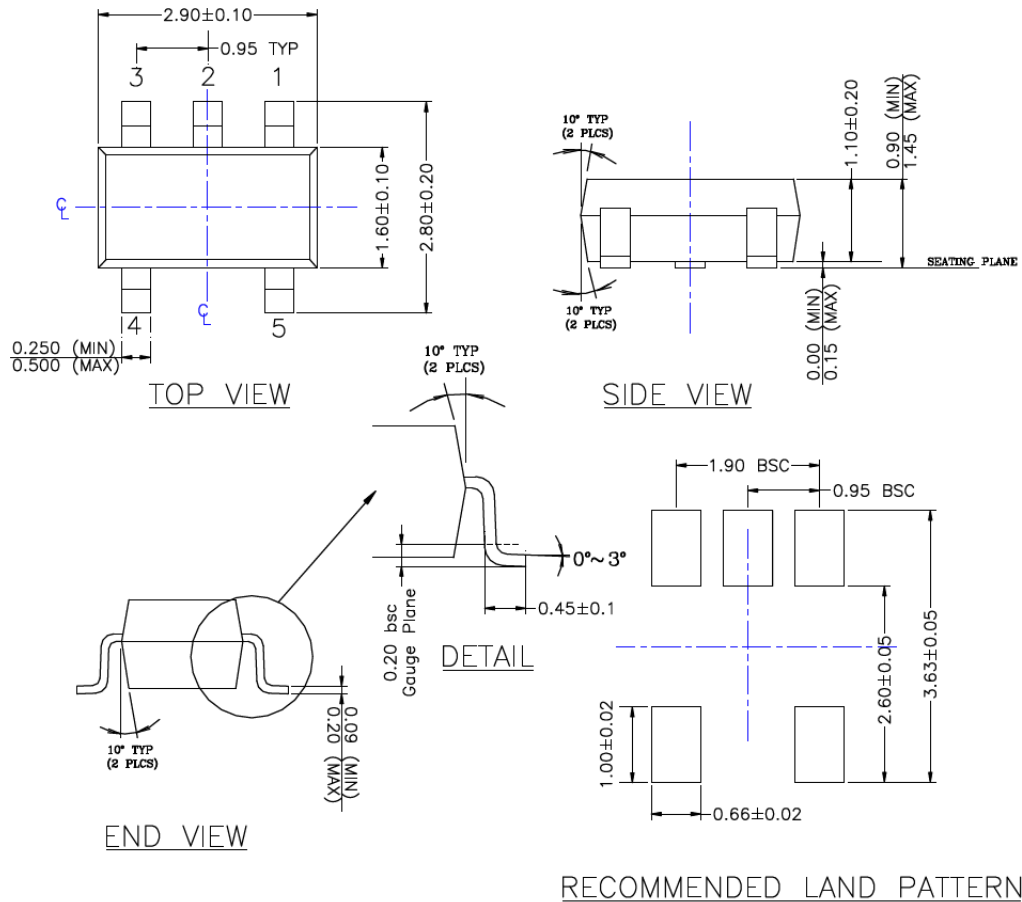
<b>Legend:</b>	XX...X	Product code or customer-specific information
	Y	Year code (last digit of calendar year)
	YY	Year code (last 2 digits of calendar year)
	WW	Week code (week of January 1 is week '01')
	NNN	Alphanumeric traceability code
	(e3)	Pb-free JEDEC® designator for Matte Tin (Sn)
	*	This package is Pb-free. The Pb-free JEDEC designator ((e3)) can be found on the outer packaging for this package.
	•, ▲, ▼	Pin one index is identified by a dot, delta up, or delta down (triangle mark).
<b>Note:</b>	In the event the full Microchip part number cannot be marked on one line, it will be carried over to the next line, thus limiting the number of available characters for customer-specific information. Package may or may not include the corporate logo.	
	Underbar (¯) and/or Overbar (¯) symbol may not be to scale.	

## 5-Lead SOT23 Package Outline and Recommended Land Pattern

**TITLE**

5 LEAD SOT23 PACKAGE OUTLINE & RECOMMENDED LAND PATTERN

<b>DRAWING #</b>	SOT23-5LD-PL-1	<b>UNIT</b>	MM
------------------	----------------	-------------	----



**NOTE:**

1. PACKAGE OUTLINE EXCLUSIVE OF MOLD FLASH & BURR.
2. PACKAGE OUTLINE INCLUSIVE OF SOLER PLATING.
3. DIMENSION AND TOLERANCE PER ANSI Y14.5M, 1982.
4. FOOT LENGTH MEASUREMENT BASED ON GAUGE PLANE METHOD.
5. DIE FACES UP FOR MOLD, AND FACES DOWN FOR TRIM/FORM.
6. ALL DIMENSIONS ARE IN MILLIMETERS.

Note: For the most current package drawings, please see the Microchip Packaging Specification located at <http://www.microchip.com/packaging>.

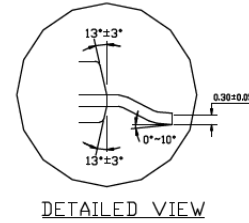
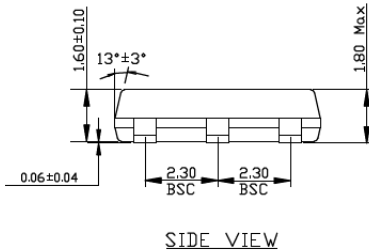
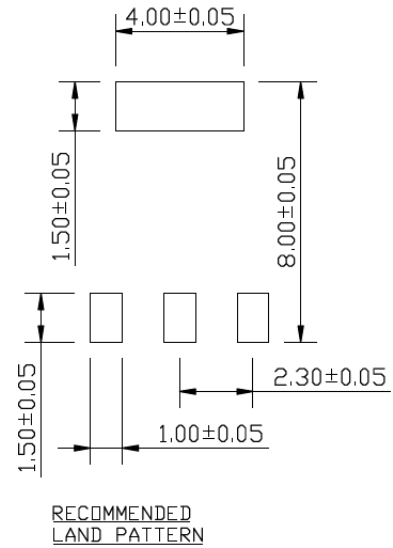
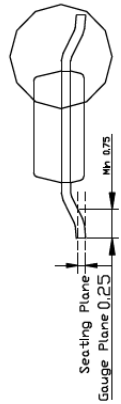
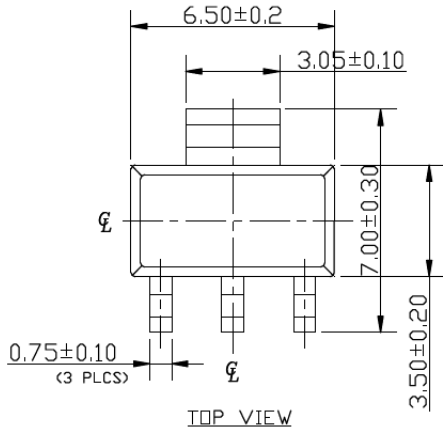
# MIC5233

## 3-Lead SOT223 Package Outline and Recommended Land Pattern

**TITLE**

3 LEAD SOT223 PACKAGE OUTLINE & RECOMMENDED LAND PATTERN

DRAWING #	SOT223-3LD-PL-1	UNIT	MM
-----------	-----------------	------	----



**NOTE:**

1. Dimensions and tolerances are as per ANSI Y14.5M, 1982.
2. Controlling dimension: Millimeters.
3. Dimensions are exclusive of mold flash and gate burr.
4. All specification comply to Jedec spec TO261 Issue C.

Note: For the most current package drawings, please see the Microchip Packaging Specification located at <http://www.microchip.com/packaging>.

## APPENDIX A: REVISION HISTORY

### Revision D (July 2019)

- Updated the [Features](#) section.

### Revision C (February 2019)

- Information about the Automotive Grade option added in [Features](#) but removed from [Package Types](#), and the [Product Identification System](#) sections of the data sheet.
- Updated the [Typical Application Circuit](#) on the very first page.

### Revision B (June 2018)

- Unbolded values for  $V_{EN}$  in [Table 1-1](#).
- The condition for Start-Up Time in the [Electrical Characteristics](#) table is updated.

### Revision A (May 2018)

- Converted Micrel document MIC5233 to Microchip data sheet DS20006033A.
- Minor text changes throughout.
- Information about the Automotive Grade option added in [Features](#), [Package Types](#), and the [Product Identification System](#) sections of the data sheet.

# MIC5233

---

NOTES:

## PRODUCT IDENTIFICATION SYSTEM

To order or obtain information, e.g., on pricing or delivery, contact your local Microchip representative or sales office.

<u>PART NO.</u>	<u>-X.X</u>	<u>X</u>	<u>XXX</u>	<u>-XX</u>
Device	Output Voltage	Junction Temperature Range	Package	Media Type
<b>Device:</b>	MIC5233: High Input Voltage, Low I <sub>Q</sub> µCap LDO Regulator			
<b>Output Voltage:</b>	1.8 = 1.8V 2.5 = 2.5V 3.0 = 3.0V 3.3 = 3.3V 5.0 = 5.0V Adjustable <blank> = Adjustable			
<b>Junction Temperature Range:</b>	Y = -40°C to +125°C			
<b>Package:</b>	M5 = 5-Lead SOT23 S = 3-Lead SOT223			
<b>Media Type:</b>	<blank> = 78/Tube (SOT223 Only) TR = 2,500/Reel (SOT223 Only) TR = 3000/Reel (SOT23 Only)			
<b>Examples:</b>				
a) MIC5233-1.8YM5-TR: High Input Voltage, Low I <sub>Q</sub> µCap LDO Regulator, 1.8V, -40°C to +125°C, 5-Lead SOT23, 3000/Reel				
b) MIC5233-2.5YM5-TR: High Input Voltage, Low I <sub>Q</sub> µCap LDO Regulator, 2.5V, -40°C to +125°C, 5-Lead SOT23, 3000/Reel				
c) MIC5233-3.0YM5-TR: High Input Voltage, Low I <sub>Q</sub> µCap LDO Regulator, 3.0V, -40°C to +125°C, 5-Lead SOT23, 3000/Reel				
d) MIC5233-3.3YM5-TR: High Input Voltage, Low I <sub>Q</sub> µCap LDO Regulator, 3.3V, -40°C to +125°C, 5-Lead SOT23, 3000/Reel				
e) MIC5233-5.0YM5-TR: High Input Voltage, Low I <sub>Q</sub> µCap LDO Regulator, 5.0V, -40°C to +125°C, 5-Lead SOT23, 3000/Reel				
f) MIC5233YM5-TR: High Input Voltage, Low I <sub>Q</sub> µCap LDO Regulator, Adjustable, -40°C to +125°C, 5-Lead SOT23, 3000/Reel				
g) MIC5233-3.3YS: High Input Voltage, Low I <sub>Q</sub> µCap LDO Regulator, 3.3V, -40°C to +125°C, 3-Lead SOT223, 78/Tube				
h) MIC5233-5.0YS: High Input Voltage, Low I <sub>Q</sub> µCap LDO Regulator, 5.0V, -40°C to +125°C, 3-Lead SOT223, 78/Tube				
i) MIC5233-5.0YS-TR: High Input Voltage, Low I <sub>Q</sub> µCap LDO Regulator, 5.0V, -40°C to +125°C, 3-Lead SOT223, 2500/Reel				
<b>Note:</b> Tape and Reel identifier only appears in the catalog part number description. This identifier is used for ordering purposes and is not printed on the device package. Check with your Microchip Sales Office for package availability with the Tape and Reel option.				

# MIC5233

---

NOTES:

---

**Note the following details of the code protection feature on Microchip devices:**

- Microchip products meet the specification contained in their particular Microchip Data Sheet.
- Microchip believes that its family of products is one of the most secure families of its kind on the market today, when used in the intended manner and under normal conditions.
- There are dishonest and possibly illegal methods used to breach the code protection feature. All of these methods, to our knowledge, require using the Microchip products in a manner outside the operating specifications contained in Microchip's Data Sheets. Most likely, the person doing so is engaged in theft of intellectual property.
- Microchip is willing to work with the customer who is concerned about the integrity of their code.
- Neither Microchip nor any other semiconductor manufacturer can guarantee the security of their code. Code protection does not mean that we are guaranteeing the product as “unbreakable.”

Code protection is constantly evolving. We at Microchip are committed to continuously improving the code protection features of our products. Attempts to break Microchip's code protection feature may be a violation of the Digital Millennium Copyright Act. If such acts allow unauthorized access to your software or other copyrighted work, you may have a right to sue for relief under that Act.

---

Information contained in this publication regarding device applications and the like is provided only for your convenience and may be superseded by updates. It is your responsibility to ensure that your application meets with your specifications. MICROCHIP MAKES NO REPRESENTATIONS OR WARRANTIES OF ANY KIND WHETHER EXPRESS OR IMPLIED, WRITTEN OR ORAL, STATUTORY OR OTHERWISE, RELATED TO THE INFORMATION, INCLUDING BUT NOT LIMITED TO ITS CONDITION, QUALITY, PERFORMANCE, MERCHANTABILITY OR FITNESS FOR PURPOSE. Microchip disclaims all liability arising from this information and its use. Use of Microchip devices in life support and/or safety applications is entirely at the buyer's risk, and the buyer agrees to defend, indemnify and hold harmless Microchip from any and all damages, claims, suits, or expenses resulting from such use. No licenses are conveyed, implicitly or otherwise, under any Microchip intellectual property rights unless otherwise stated.

**Trademarks**

The Microchip name and logo, the Microchip logo, Adaptec, AnyRate, AVR, AVR logo, AVR Freaks, BesTime, BitCloud, chipKIT, chipKIT logo, CryptoMemory, CryptoRF, dsPIC, FlashFlex, flexPWR, HELDO, IGLOO, JukeBlox, KeeLoq, Klear, LANCheck, LinkMD, maXStylus, maXTouch, MediaLB, megaAVR, Microsemi, Microsemi logo, MOST, MOST logo, MPLAB, OptoLyzer, PackeTime, PIC, picoPower, PICSTART, PIC32 logo, PolarFire, Prochip Designer, QTouch, SAM-BA, SenGenuity, SpyNIC, SST, SST Logo, SuperFlash, Symmetricom, SyncServer, Tachyon, TempTracker, TimeSource, tinyAVR, UNI/O, Vectron, and XMEGA are registered trademarks of Microchip Technology Incorporated in the U.S.A. and other countries.

APT, ClockWorks, The Embedded Control Solutions Company, EtherSynch, FlashTec, Hyper Speed Control, HyperLight Load, IntelliMOS, Libero, motorBench, mTouch, Powermite 3, Precision Edge, ProASIC, ProASIC Plus, ProASIC Plus logo, Quiet-Wire, SmartFusion, SyncWorld, Temux, TimeCesium, TimeHub, TimePictra, TimeProvider, Vite, WinPath, and ZL are registered trademarks of Microchip Technology Incorporated in the U.S.A.

Adjacent Key Suppression, AKS, Analog-for-the-Digital Age, Any Capacitor, AnyIn, AnyOut, BlueSky, BodyCom, CodeGuard, CryptoAuthentication, CryptoAutomotive, CryptoCompanion, CryptoController, dsPICDEM, dsPICDEM.net, Dynamic Average Matching, DAM, ECAN, EtherGREEN, In-Circuit Serial Programming, ICSP, INICnet, Inter-Chip Connectivity, JitterBlocker, KlearNet, KlearNet logo, memBrain, Mindi, MiWi, MPASM, MPF, MPLAB Certified logo, MPLIB, MPLINK, MultiTRAK, NetDetach, Omniscient Code Generation, PICDEM, PICDEM.net, PICKit, PICtail, PowerSmart, PureSilicon, QMatrix, REAL ICE, Ripple Blocker, SAM-ICE, Serial Quad I/O, SMART-I.S., SQI, SuperSwitcher, SuperSwitcher II, Total Endurance, TSHARC, USBCheck, VariSense, ViewSpan, WiperLock, Wireless DNA, and ZENA are trademarks of Microchip Technology Incorporated in the U.S.A. and other countries.

SQTP is a service mark of Microchip Technology Incorporated in the U.S.A.

The Adaptec logo, Frequency on Demand, Silicon Storage Technology, and Symmcom are registered trademarks of Microchip Technology Inc. in other countries.

GestIC is a registered trademark of Microchip Technology Germany II GmbH & Co. KG, a subsidiary of Microchip Technology Inc., in other countries.

All other trademarks mentioned herein are property of their respective companies.

© 2018-2019, Microchip Technology Incorporated, All Rights Reserved.

ISBN: 978-1-5224-4759-7

For information regarding Microchip's Quality Management Systems, please visit [www.microchip.com/quality](http://www.microchip.com/quality).



# MICROCHIP

## Worldwide Sales and Service

### AMERICAS

**Corporate Office**  
2355 West Chandler Blvd.  
Chandler, AZ 85224-6199  
Tel: 480-792-7200  
Fax: 480-792-7277  
Technical Support:  
<http://www.microchip.com/support>  
Web Address:  
[www.microchip.com](http://www.microchip.com)

#### Atlanta

Duluth, GA  
Tel: 678-957-9614  
Fax: 678-957-1455

#### Austin, TX

Tel: 512-257-3370

#### Boston

Westborough, MA  
Tel: 774-760-0087  
Fax: 774-760-0088

#### Chicago

Itasca, IL  
Tel: 630-285-0071  
Fax: 630-285-0075

#### Dallas

Addison, TX  
Tel: 972-818-7423  
Fax: 972-818-2924

#### Detroit

Novi, MI  
Tel: 248-848-4000

#### Houston, TX

Tel: 281-894-5983

#### Indianapolis

Noblesville, IN  
Tel: 317-773-8323  
Fax: 317-773-5453  
Tel: 317-536-2380

#### Los Angeles

Mission Viejo, CA  
Tel: 949-462-9523  
Fax: 949-462-9608  
Tel: 951-273-7800

#### Raleigh, NC

Tel: 919-844-7510

#### New York, NY

Tel: 631-435-6000

#### San Jose, CA

Tel: 408-735-9110  
Tel: 408-436-4270

#### Canada - Toronto

Tel: 905-695-1980  
Fax: 905-695-2078

### ASIA/PACIFIC

**Australia - Sydney**  
Tel: 61-2-9868-6733

**China - Beijing**  
Tel: 86-10-8569-7000

**China - Chengdu**  
Tel: 86-28-8665-5511

**China - Chongqing**  
Tel: 86-23-8980-9588

**China - Dongguan**  
Tel: 86-769-8702-9880

**China - Guangzhou**  
Tel: 86-20-8755-8029

**China - Hangzhou**  
Tel: 86-571-8792-8115

**China - Hong Kong SAR**  
Tel: 852-2943-5100

**China - Nanjing**  
Tel: 86-25-8473-2460

**China - Qingdao**  
Tel: 86-532-8502-7355

**China - Shanghai**  
Tel: 86-21-3326-8000

**China - Shenyang**  
Tel: 86-24-2334-2829

**China - Shenzhen**  
Tel: 86-755-8864-2200

**China - Suzhou**  
Tel: 86-186-6233-1526

**China - Wuhan**  
Tel: 86-27-5980-5300

**China - Xian**  
Tel: 86-29-8833-7252

**China - Xiamen**  
Tel: 86-592-2388138

**China - Zhuhai**  
Tel: 86-756-3210040

### ASIA/PACIFIC

**India - Bangalore**  
Tel: 91-80-3090-4444

**India - New Delhi**  
Tel: 91-11-4160-8631

**India - Pune**  
Tel: 91-20-4121-0141

**Japan - Osaka**  
Tel: 81-6-6152-7160

**Japan - Tokyo**  
Tel: 81-3-6880-3770

**Korea - Daegu**  
Tel: 82-53-744-4301

**Korea - Seoul**  
Tel: 82-2-554-7200

**Malaysia - Kuala Lumpur**  
Tel: 60-3-7651-7906

**Malaysia - Penang**  
Tel: 60-4-227-8870

**Philippines - Manila**  
Tel: 63-2-634-9065

**Singapore**  
Tel: 65-6334-8870

**Taiwan - Hsin Chu**  
Tel: 886-3-577-8366

**Taiwan - Kaohsiung**  
Tel: 886-7-213-7830

**Taiwan - Taipei**  
Tel: 886-2-2508-8600

**Thailand - Bangkok**  
Tel: 66-2-694-1351

**Vietnam - Ho Chi Minh**  
Tel: 84-28-5448-2100

### EUROPE

**Austria - Wels**  
Tel: 43-7242-2244-39  
Fax: 43-7242-2244-393

**Denmark - Copenhagen**  
Tel: 45-4450-2828  
Fax: 45-4485-2829

**Finland - Espoo**  
Tel: 358-9-4520-820

**France - Paris**  
Tel: 33-1-69-53-63-20  
Fax: 33-1-69-30-90-79

**Germany - Garching**  
Tel: 49-8931-9700

**Germany - Haan**  
Tel: 49-2129-3766400

**Germany - Heilbronn**  
Tel: 49-7131-72400

**Germany - Karlsruhe**  
Tel: 49-721-625370

**Germany - Munich**  
Tel: 49-89-627-144-0  
Fax: 49-89-627-144-44

**Germany - Rosenheim**  
Tel: 49-8031-354-560

**Israel - Ra'anana**  
Tel: 972-9-744-7705

**Italy - Milan**  
Tel: 39-0331-742611  
Fax: 39-0331-466781

**Italy - Padova**  
Tel: 39-049-7625286

**Netherlands - Drunen**  
Tel: 31-416-690399  
Fax: 31-416-690340

**Norway - Trondheim**  
Tel: 47-7288-4388

**Poland - Warsaw**  
Tel: 48-22-3325737

**Romania - Bucharest**  
Tel: 40-21-407-87-50

**Spain - Madrid**  
Tel: 34-91-708-08-90  
Fax: 34-91-708-08-91

**Sweden - Gothenberg**  
Tel: 46-31-704-60-40

**Sweden - Stockholm**  
Tel: 46-8-5090-4654

**UK - Wokingham**  
Tel: 44-118-921-5800  
Fax: 44-118-921-5820

## Looking for pricing, stock, or lifecycle information?

Click below to explore more details on WIN SOURCE:

- ⊖ [View MIC5233-1.8YM5-TR on WIN SOURCE](#)
- ⊖ [Microchip Technology](#) Information

## Optimize Your Supply Chain with WIN SOURCE Solutions

- ✓ Global Sourcing Solution
- ✓ Obsolete Management
- ✓ Cost Control Management
- ✓ Shortage Management
- ✓ Alternative Solution
- ✓ Excess Inventory Management