



**THE DATASHEET OF  
MIC5236YMMTR**



## General Description

The MIC5236 is a low quiescent current,  $\mu$ Cap low-dropout regulator. With a maximum operating input voltage of 30V and a quiescent current of 20 $\mu$ A, it is ideal for supplying keep-alive power in systems with high-voltage batteries.

Capable of 150mA output, the MIC5236 has a dropout voltage of only 300mV. It can also survive an input transient of -20V to +60V.

As a  $\mu$ Cap LDO, the MIC5236 is stable with either a ceramic or a tantalum output capacitor. It only requires a 1.0 $\mu$ F output capacitor for stability.

The MIC5236 includes a logic compatible enable input and an undervoltage error flag indicator. Other features of the MIC5236 include thermal shutdown, current-limit, overvoltage shutdown, load-dump protection, reverse leakage protections, and reverse battery protection.

Available in the thermally enhanced SOIC-8 and MSOP-8, the MIC5236 comes in fixed 2.5V, 3.0V, 3.3V, 5.0V, and adjustable voltages. For other output voltages, contact Micrel.

## Features

- Ultra-low quiescent current ( $I_Q = 20\mu\text{A} @ I_O = 100\mu\text{A}$ )
- Wide input range: 2.3V to 30V
- Low dropout:
  - 230mV @50mA;
  - 300mV @150mA
- Fixed 2.5V, 3.0V, 3.3V, 5.0V, and Adjustable outputs
- $\pm 1.0\%$  initial output accuracy
- Stable with ceramic or tantalum output capacitor
- Load dump protection: -20V to +60V input transient survivability
- Logic compatible enable input
- Low output flag indicator
- Overcurrent protection
- Thermal shutdown
- Reverse-leakage protection
- Reverse-battery protection
- High-power SOIC-8 and MSOP-8

## Applications

- Keep-alive supply in notebook and portable personal computers
- Logic supply from high-voltage batteries
- Automotive electronics
- Battery-powered systems

## Typical Application

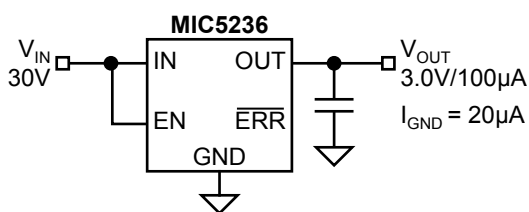

Regulator with Low  $I_O$  and Low  $I_Q$

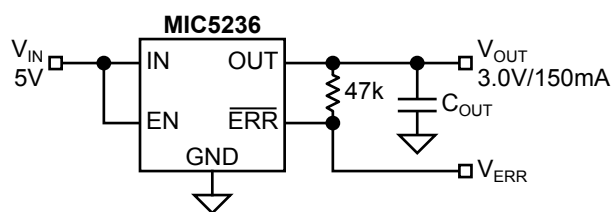

Regulator with Error Output

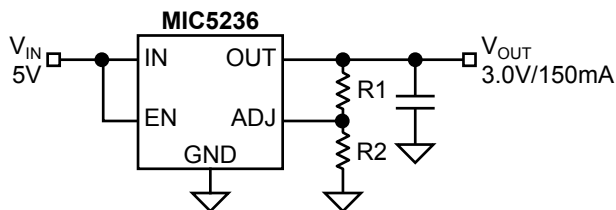

Regulator with Adjustable Output

## Ordering Information

| Part Number*   |                | Voltage | Junction Temp. Range | Package    |
|----------------|----------------|---------|----------------------|------------|
| Standard       | Pb-Free        |         |                      |            |
| MIC5236BM      | MIC5236YM      | ADJ     | -40°C to +125°C      | 8-Pin SOIC |
| MIC5236BMM     | MIC5236YMM     | ADJ     | -40°C to +125°C      | 8-Pin MSOP |
| MIC5236-2.5BM  | MIC5236-2.5YM  | 2.5V    | -40°C to +125°C      | 8-Pin SOIC |
| MIC5236-2.5BMM | MIC5236-2.5YMM | 2.5V    | -40°C to +125°C      | 8-Pin MSOP |
| MIC5236-3.0BM  | MIC5236-3.0YM  | 3.0V    | -40°C to +125°C      | 8-Pin SOIC |
| MIC5236-3.0BMM | MIC5236-3.0YMM | 3.0V    | -40°C to +125°C      | 8-Pin MSOP |
| MIC5236-3.3BM  | MIC5236-3.3YM  | 3.3V    | -40°C to +125°C      | 8-Pin SOIC |
| MIC5236-3.3BMM | MIC5236-3.3YMM | 3.3V    | -40°C to +125°C      | 8-Pin MSOP |
| MIC5236-5.0BM  | MIC5236-5.0YM  | 5.0V    | -40°C to +125°C      | 8-Pin SOIC |
| MIC5236-5.0BMM | MIC5236-5.0YMM | 5.0V    | -40°C to +125°C      | 8-Pin MSOP |

\* Contact factory regarding availability for voltages not listed

## Pin Configuration



8-Pin SOIC (M)  
8-Pin MSOP (MM)



8-Pin SOIC (M)  
8-Pin MSOP (MM)

## Pin Description

| Pin Number | Pin Number | Pin Name | Pin Function  |
|------------|------------|----------|---|
|            | 1          | /ERR     | Error (Output): Open-collector output is active low when the output is out of regulation due to insufficient input voltage or excessive load. An external pull-up resistor is required. |
| 1          |            | ADJ      | Adjustable Feedback Input. Connect to voltage divider network.  |
| 2          | 2          | IN       | Power supply input.   |
| 3          | 3          | OUT      | Regulated Output  |
| 4          | 4          | EN       | Enable (Input): Logic low = shutdown; logic high = enabled.   |
| 5-8        | 5-8        | GND      | Ground: Pins 5, 6, 7, and 8 are internally connected in common via the lead-frame.  |

**Absolute Maximum Ratings (Note 1)**

|  |                    |
|--|--------------------|
| Supply Voltage ( $V_{IN}$ ), <b>Note 3</b> ..... | -20V to +60V       |
| Power Dissipation ( $P_D$ ), <b>Note 4</b> ..... | Internally Limited |
| Junction Temperature ( $T_J$ ) .....             | +150°C             |
| Storage Temperature ( $T_S$ ) .....              | -65°C to +150°C    |
| Lead Temperature (soldering, 5 sec.) .....       | 260°C              |
| ESD Rating, <b>Note 5</b>                        |                    |

**Operating Ratings (Note 2)**

|                                      |                 |
|--------------------------------------|-----------------|
| Supply Voltage ( $V_{IN}$ ) .....    | + 2.3V to +30V  |
| Junction Temperature ( $T_J$ ) ..... | -40°C to +125°C |
| Package Thermal Resistance           |                 |
| MSOP ( $\theta_{JA}$ ) .....         | 80°C/W          |
| SOIC ( $\theta_{JA}$ ) .....         | 63°C/W          |

**Electrical Characteristics**

$V_{IN} = 6.0V$ ;  $V_{EN} = 2.0V$ ;  $C_{OUT} = 4.7\mu F$ ;  $I_{OUT} = 100\mu A$ ;  $T_J = 25^\circ C$ , **bold** values indicate  $-40^\circ C \leq T_J \leq +125^\circ C$ ; unless noted.

| Symbol                              | Parameter                      | Conditions  | Min | Typ  | Max               | Units         |
|-------------------------------------|--------------------------------|---|-----|------|-------------------|---------------|
| $V_{OUT}$                           | Output Voltage Accuracy        | variation from nominal $V_{OUT}$                    | -1  |      | 1                 | %             |
|                                     |                                |   | -2  |      | +2                | %             |
| $\Delta V_{OUT}/\Delta T$<br>ppm/°C | Output Voltage                 | <b>Note 6</b>                                       |     | 50   |                   |               |
|                                     | Temperature Coefficient        |   |     |      |                   |               |
| $\Delta V_{OUT}/V_{OUT}$            | Line Regulation                | $V_{IN} = V_{OUT} + 1V$ to 30V                      |     | 0.2  | 0.5<br><b>1.0</b> | %<br>%        |
| $\Delta V_{OUT}/V_{OUT}$            | Load Regulation                | $I_{OUT} = 100\mu A$ to 50mA, <b>Note 7</b>         |     | 0.15 | 0.3<br><b>0.5</b> | %<br>%        |
|                                     |                                | $I_{OUT} = 100\mu A$ to 150mA, <b>Note 7</b>        |     | 0.3  | 0.6<br><b>1.0</b> | %<br>%        |
| $\Delta V$                          | Dropout Voltage, <b>Note 8</b> | $I_{OUT} = 100\mu A$                                |     | 50   | <b>100</b>        | mV            |
|                                     |                                | $I_{OUT} = 50mA$                                    |     | 230  | <b>400</b>        | mV            |
|                                     |                                | $I_{OUT} = 100mA$                                   |     | 270  |                   | mV            |
|                                     |                                | $I_{OUT} = 150mA$                                   |     | 300  | <b>500</b>        | mV            |
| $I_{GND}$                           | Ground Pin Current             | $V_{EN} \geq 2.0V$ , $I_{OUT} = 100\mu A$           |     | 20   | <b>30</b>         | $\mu A$       |
|                                     |                                | $V_{EN} \geq 2.0V$ , $I_{OUT} = 50mA$               |     | 0.5  | <b>0.8</b>        | mA            |
|                                     |                                | $V_{EN} \geq 2.0V$ , $I_{OUT} = 100mA$              |     | 1.5  |                   | mA            |
|                                     |                                | $V_{EN} \geq 2.0V$ , $I_{OUT} = 150mA$              |     | 2.8  | 4.0<br><b>5.0</b> | mA<br>mA      |
| $I_{GND(SHDN)}$                     | Ground Pin in Shutdown         | $V_{EN} \leq 0.6V$ , $V_{IN} = 30V$                 |     | 0.1  | 1                 | $\mu A$       |
| $I_{SC}$                            | Short Circuit Current          | $V_{OUT} = 0V$                                      |     | 260  | <b>350</b>        | mA            |
| $e_n$                               | Output Noise                   | 10Hz to 100kHz, $V_{OUT} = 3.0V$ , $C_L = 1.0\mu F$ |     | 160  |                   | $\mu V_{rms}$ |

**/ERR Output**

|            |                         |   |    |     |                   |          |
|------------|-------------------------|---|----|-----|-------------------|----------|
| $V_{/ERR}$ | Low Threshold           | % of $V_{OUT}$  | 90 | 94  |                   | %        |
|            | High Threshold          | % of $V_{OUT}$  |    | 95  | 98                | %        |
| $V_{OL}$   | /ERR Output Low Voltage | $V_{IN} = V_{OUT(nom)} - 0.12V_{OUT}$ , $I_{OL} = 200\mu A$ |    | 150 | 250<br><b>400</b> | mV<br>mV |
| $I_{LEAK}$ | /ERR Output Leakage     | $V_{OH} = 30V$  |    | 0.1 | 1                 | $\mu A$  |
|            |                         |   |    |     | <b>2</b>          | $\mu A$  |

**Enable Input**

|          |                    |               |     |  |     |   |
|----------|--------------------|---------------|-----|--|-----|---|
| $V_{IL}$ | Input Low Voltage  | regulator off |     |  | 0.6 | V |
| $V_{IH}$ | Input High Voltage | regulator on  | 2.0 |  |     | V |

| Symbol   | Parameter            | Conditions                      | Min | Typ  | Max               | Units              |
|----------|----------------------|---------------------------------|-----|------|-------------------|--------------------|
| $I_{IN}$ | Enable Input Current | $V_{EN} = 0.6V$ , regulator off |     | 0.01 | 1.0<br><b>2.0</b> | $\mu A$<br>$\mu A$ |
|          |                      | $V_{EN} = 2.0V$ , regulator on  |     | 0.15 | 1.0<br><b>2.0</b> | $\mu A$<br>$\mu A$ |
|          |                      | $V_{EN} = 30V$ , regulator on   |     | 0.5  | 2.5<br><b>5.0</b> | $\mu A$<br>$\mu A$ |

**Note 1.** Exceeding the absolute maximum rating may damage the device.

**Note 2.** The device is not guaranteed to function outside its operating rating.

**Note 3:** The absolute maximum positive supply voltage (60V) must be of limited duration ( $\leq 100ms$ ) and duty cycle ( $\leq 1\%$ ). The maximum continuous supply voltage is 30V.

**Note 4:** The maximum allowable power dissipation of any  $T_A$  (ambient temperature) is  $P_{D(max)} = (T_{J(max)} - T_A) \div \theta_{JA}$ . Exceeding the maximum allowable power dissipation will result in excessive die temperature, and the regulator will go into thermal shutdown. The  $\theta_{JA}$  of the MIC5236-x.xBM (all versions) is  $63^\circ C/W$ , and the MIC5236-x.xBMM (all versions) is  $80^\circ C/W$ , mounted on a PC board (see "Thermal Characteristics" for further details).

**Note 5.** Devices are ESD sensitive. Handling precautions recommended. Human body model, 1.5k in series with 100pF.

**Note 6:** Output voltage temperature coefficient is defined as the worst-case voltage change divided by the total temperature range.

**Note 7:** Regulation is measured at constant junction temperature using pulse testing with a low duty-cycle. Changes in output voltage due to heating effects are covered by the specification for thermal regulation.

**Note 8:** Dropout voltage is defined as the input to output differential at which the output voltage drops 2% below its nominal value measured at 1.0V differential.

# Typical Characteristics

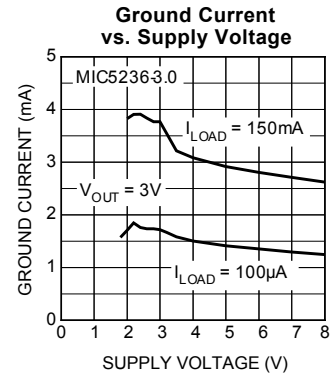

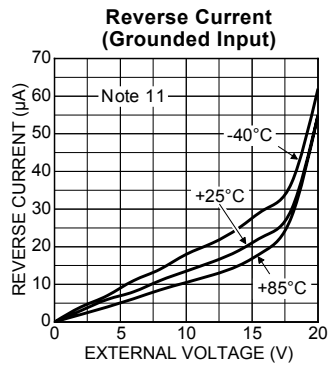
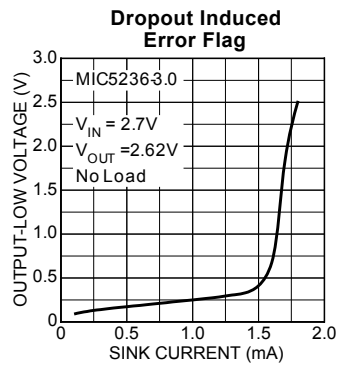

Note 10

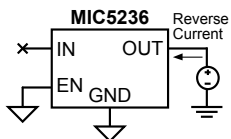

Note 11

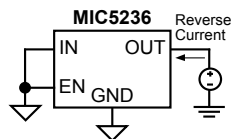

# Functional Characteristics

### Enable Transient Response



### Load Transient Response

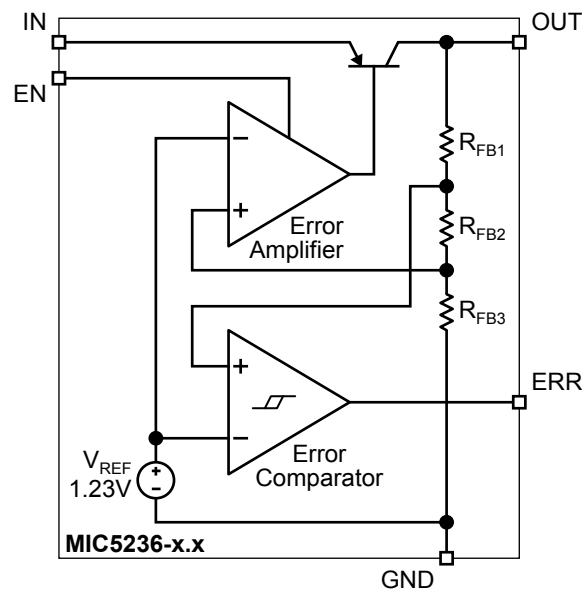

**Functional Diagram**

## Application Information

The MIC5236 provides all of the advantages of the MIC2950: wide input voltage range, load dump (positive transients up to 60V), and reversed-battery protection, with the added advantages of reduced quiescent current and smaller package. Additionally, when disabled, quiescent current is reduced to 0.1 $\mu$ A.

### Enable

A low on the enable pin disables the part, forcing the quiescent current to less than 0.1 $\mu$ A. Thermal shutdown and the error flag are not functional while the device is disabled. The maximum enable bias current is 2 $\mu$ A for a 2.0V input. An open collector pull-up resistor tied to the input voltage should be set low enough to maintain 2V on the enable input. Figure 1 shows an open collector output driving the enable pin through a 200k pull-up resistor tied to the input voltage.

In order to avoid output oscillations, slow transitions from low to high should be avoided.

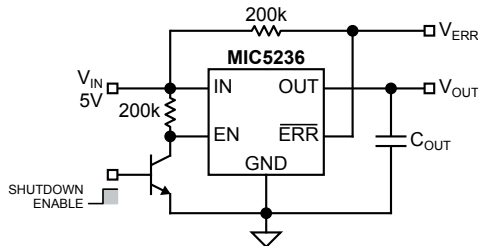

Figure 1. Remote Enable

### Input Capacitor

An input capacitor may be required when the device is not near the source power supply or when supplied by a battery. Small, surface mount, ceramic capacitors can be used for bypassing. Larger values may be required if the source supply has high ripple.

### Output Capacitor

The MIC5236 has been designed to minimize the effect of the output capacitor ESR on the closed loop stability. As a result, ceramic or film capacitors can be used at the output. Figure 2 displays a range of ESR values for a 10 $\mu$ F capacitor. Virtually any 10 $\mu$ F capacitor with an ESR less than 3.4 $\Omega$  is sufficient for stability over the entire input voltage range. Stability can also be maintained throughout the specified load and line conditions with 1 $\mu$ F film or ceramic capacitors.

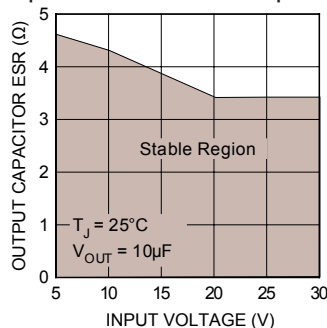

Figure 2. Output Capacitor ESR

## Error Detection Comparator Output

The ERR pin is an open collector output which goes low when the output voltage drops 5% below its internally programmed level. It senses conditions such as excessive load (current limit), low input voltage, and over temperature conditions. Once the part is disabled via the enable input, the error flag output is not valid. Overvoltage conditions are not reflected in the error flag output. The error flag output is also not valid for input voltages less than 2.3V.

The error output has a low voltage of 400mV at a current of 200 $\mu$ A. In order to minimize the drain on the source used for the pull-up, a value of 200k to 1M $\Omega$  is suggested for the error flag pull-up. This will guarantee a maximum low voltage of 0.4V for a 30V pull-up potential. An unused error flag can be left unconnected.

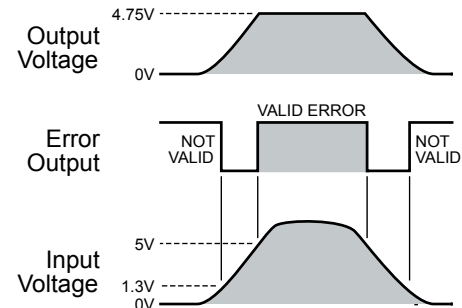

Figure 3. Error Output Timing

## Reverse Current Protection

The MIC5236 is designed to limit the reverse current flow from output to input in the event that the MIC5236 output has been tied to the output of another power supply. See the graphs detailing the reverse current flow with the input grounded and open.

## Thermal Shutdown

The MIC5236 has integrated thermal protection. This feature is only for protection purposes. The device should never be intentionally operated near this temperature as this may have detrimental effects on the life of the device. The thermal shutdown may become inactive while the enable input is transitioning a high to a low. When disabling the device via the enable pin, transition from a high to low quickly. This will insure that the output remains disabled in the event of a thermal shutdown.

## Current Limit

Figure 4 displays a method for reducing the steady state short circuit current. The duration that the supply delivers current is set by the time required for the error flag output to discharge the 4.7 $\mu$ F capacitor tied to the enable pin. The off time is set by the 200K resistor as it recharges the 4.7 $\mu$ F capacitor, enabling the regulator. This circuit reduces the short circuit current from 280mA to 15mA while allowing for regulator restart once the short is removed.



**Figure 4. Remote Enable with Short-Circuit Current Foldback**

**Thermal Characteristics**

The MIC5236 is a high input voltage device, intended to provide 150mA of continuous output current in two very small profile packages. The power SOIC-8 and power MSOP-8 allow the device to dissipate about 50% more power than their standard equivalents.

**Power SOIC-8 Thermal Characteristics**

One of the secrets of the MIC5236's performance is its power SO-8 package featuring half the thermal resistance of a standard SO-8 package. Lower thermal resistance means more output current or higher input voltage for a given package size.

Lower thermal resistance is achieved by joining the four ground leads with the die attach paddle to create a single-piece electrical and thermal conductor. This concept has been used by MOSFET manufacturers for years, proving very reliable and cost effective for the user.

Thermal resistance consists of two main elements,  $\theta_{JC}$  (junction-to-case thermal resistance) and  $\theta_{CA}$  (case-to-ambient thermal resistance). See Figure 5.  $\theta_{JC}$  is the resistance from the die to the leads of the package.  $\theta_{CA}$  is the resistance from the leads to the ambient air and it includes  $\theta_{CS}$  (case-to-sink thermal resistance) and  $\theta_{SA}$  (sink-to-ambient thermal resistance).

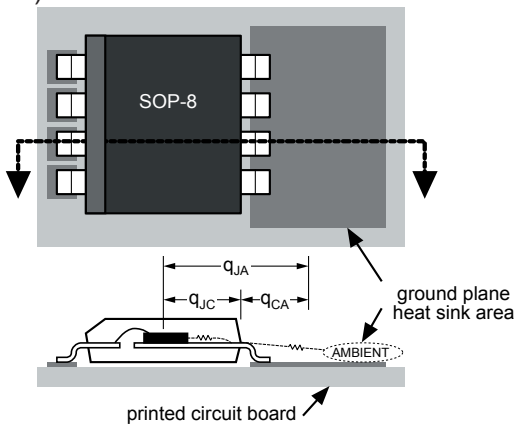
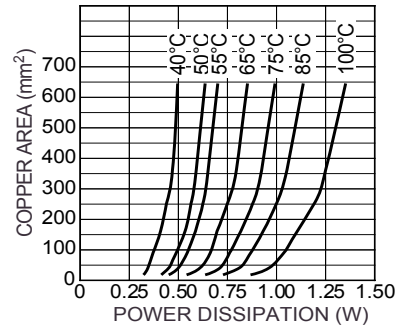

**Figure 5. Thermal Resistance**

Using the power SOIC-8 reduces the  $\theta_{JC}$  dramatically and allows the user to reduce  $\theta_{CA}$ . The total thermal resistance,  $\theta_{JA}$  (junction-to-ambient thermal resistance) is the limiting factor in calculating the maximum power dissipation capability of the device. Typically, the power SOIC-8 has a  $\theta_{JC}$  of 20°C/W, this is significantly lower than the standard SOIC-8

which is typically 75°C/W.  $\theta_{CA}$  is reduced because pins 5 through 8 can now be soldered directly to a ground plane which significantly reduces the case-to-sink thermal resistance and sink to ambient thermal resistance.

Low-dropout linear regulators from Micrel are rated to a maximum junction temperature of 125°C. It is important not to exceed this maximum junction temperature during operation of the device. To prevent this maximum junction temperature from being exceeded, the appropriate ground plane heat sink must be used.



**Figure 6. Copper Area vs. Power-SOIC Power Dissipation ( $\Delta T_{JA}$ )**

Figure 6 shows copper area versus power dissipation with each trace corresponding to a different temperature rise above ambient.

From these curves, the minimum area of copper necessary for the part to operate safely can be determined. The maximum allowable temperature rise must be calculated to determine operation along which curve.

$$\Delta T = T_{J(max)} - T_{A(max)}$$

$$T_{J(max)} = 125^\circ C$$

$$T_{A(max)} = \text{maximum ambient operating temperature}$$

For example, the maximum ambient temperature is 50°C, the  $\Delta T$  is determined as follows:

$$\Delta T = 125^\circ C - 50^\circ C$$

$$\Delta T = 75^\circ C$$

Using Figure 6, the minimum amount of required copper can be determined based on the required power dissipation. Power dissipation in a linear regulator is calculated as follows:

$$P_D = (V_{IN} - V_{OUT}) I_{OUT} + V_{IN} \cdot I_{GND}$$

If we use a 3V output device and a 28V input at moderate output current of 25mA, then our power dissipation is as follows:

$$P_D = (28V - 3V) \times 25mA + 28V \times 250\mu A$$

$$P_D = 625mW + 7mW$$

$$P_D = 632mW$$

From Figure 6, the minimum amount of copper required to operate this application at a  $\Delta T$  of 75°C is 25mm<sup>2</sup>.

**Quick Method**

Determine the power dissipation requirements for the design along with the maximum ambient temperature at which the device will be operated. Refer to Figure 7, which shows safe operating curves for three different ambient temperatures:

25°C, 50°C and 85°C. From these curves, the minimum amount of copper can be determined by knowing the maximum power dissipation required. If the maximum ambient temperature is 50°C and the power dissipation is as above, 632mW, the curve in Figure 7 shows that the required area of copper is 25mm<sup>2</sup>.

The  $\theta_{JA}$  of this package is ideally 63°C/W, but it will vary depending upon the availability of copper ground plane to which it is attached.

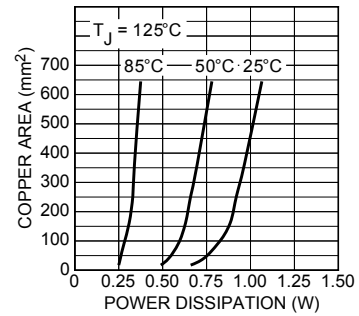

**Figure 7. Copper Area vs. Power-SOIC Power Dissipation ( $T_A$ )**



**Figure 8. Copper Area vs. Power-MSOP Power Dissipation ( $\Delta T_{JA}$ )**

The same method of determining the heat sink area used for the power-SOIC-8 can be applied directly to the power-MSOP-8. The same two curves showing power dissipation versus copper area are reproduced for the power-MSOP-8 and they can be applied identically, see Figures 8 and 9.



**Figure 9. Copper Area vs. Power-MSOP Power Dissipation ( $T_A$ )**

**Power MSOP-8 Thermal Characteristics**

The power-MSOP-8 package follows the same idea as the power-SO-8 package, using four ground leads with the die attach paddle to create a single-piece electrical and thermal conductor, reducing thermal resistance and increasing power dissipation capability.

**Quick Method**

Determine the power dissipation requirements for the design along with the maximum ambient temperature at which the device will be operated. Refer to Figure 9, which shows safe operating curves for three different ambient temperatures, 25°C, 50°C, and 85°C. From these curves, the minimum amount of copper can be determined by knowing the maximum power dissipation required. If the maximum ambient temperature is 50°C, and the power dissipation is 639mW, the curve in Figure 9 shows that the required area of copper is 110mm<sup>2</sup>, when using the power MSOP-8.

**Adjustable Regulator Application**

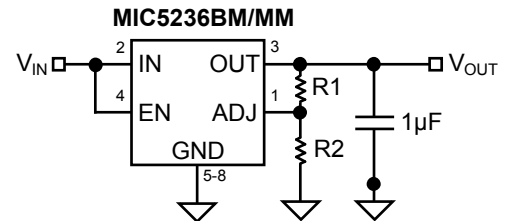

**Figure 10. Adjustable Voltage Application**

The MIC5236BM/MM can be adjusted from 1.24V to 20V by using two external resistors (Figure 10). The resistors set the output voltage based on the following equation:

$$V_{OUT} = V_{REF} \left( 1 + \frac{R1}{R2} \right)$$

Where  $V_{REF} = 1.23V$ .

Package Information

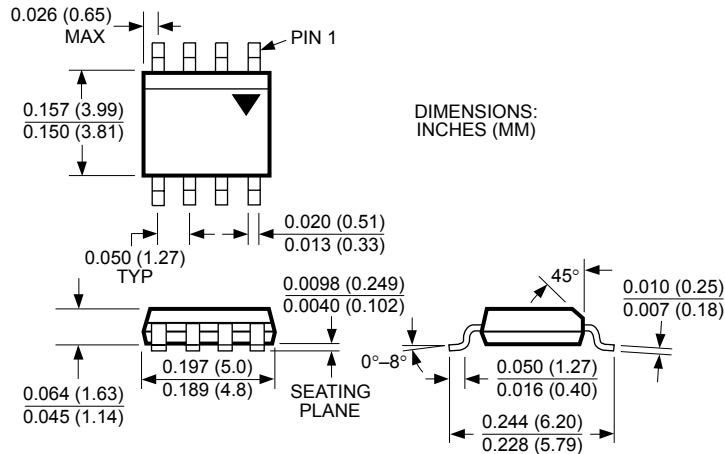

8-Pin SOIC (M)

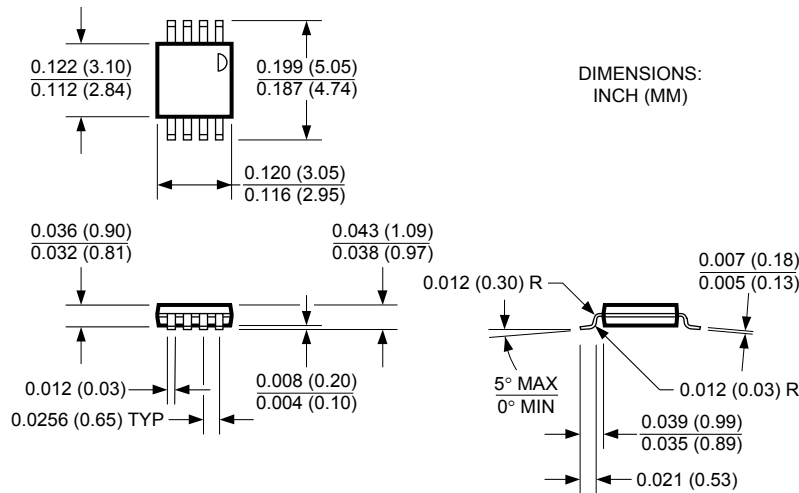

8-Pin MSOP (MM)

MICREL INC. 2180 FORTUNE DRIVE SAN JOSE, CA 95131 USA  
 TEL + 1 (408) 944-0800 FAX + 1 (408) 474-1000 WEB <http://www.micrel.com>

This information furnished by Micrel in this data sheet is believed to be accurate and reliable. However no responsibility is assumed by Micrel for its use. Micrel reserves the right to change circuitry and specifications at any time without notification to the customer.

Micrel Products are not designed or authorized for use as components in life support appliances, devices or systems where malfunction of a product can reasonably be expected to result in personal injury. Life support devices or systems are devices or systems that (a) are intended for surgical implant into the body or (b) support or sustain life, and whose failure to perform can be reasonably expected to result in a significant injury to the user. A Purchaser's use or sale of Micrel Products for use in life support appliances, devices or systems is a Purchaser's own risk and Purchaser agrees to fully indemnify Micrel for any damages resulting from such use or sale.

## Looking for pricing, stock, or lifecycle information?

Click below to explore more details on WIN SOURCE:

- ⊖ [View MIC5236YMMTR on WIN SOURCE](#)
- ⊖ [Microchip Technology Information](#)

## Optimize Your Supply Chain with WIN SOURCE Solutions

- ✓ Global Sourcing Solution
- ✓ Obsolete Management
- ✓ Cost Control Management
- ✓ Shortage Management
- ✓ Alternative Solution
- ✓ Excess Inventory Management