



**THE DATASHEET OF
MIC5245-2.8BM5TR**





The Infinite Bandwidth Company™

MIC5245

150mA μ Cap CMOS LDO Regulator

Final Information

General Description

The MIC5245 is an efficient, precise CMOS voltage regulator optimized for ultra-low-noise applications. The MIC5245 offers better than 1% initial accuracy, extremely low dropout voltage (typically 150mV at 150mA) and constant ground current over load (typically 100 μ A). The MIC5245 provides a very low noise output, ideal for RF applications where quiet voltage sources are required. A noise bypass pin is also available for further reduction of output noise.

Designed specifically for hand-held and battery-powered devices, the MIC5245 provides a TTL logic compatible enable pin. When disabled, power consumption drops nearly to zero.

The MIC5245 also works with low-ESR ceramic capacitors, reducing the amount of board space necessary for power applications, critical in hand-held wireless devices.

Key features include current limit, thermal shutdown, a push-pull output for faster transient response, and an active clamp to speed up device turnoff. Available in the IttyBitty™ SOT-23-5 and power MSO-8 packages, the MIC5245 also offers a range of fixed output voltages.

Not recommended for new designs, see MIC5255.

Features

- Ultralow dropout—100mV @ 100mA
- Ultralow noise—30 μ V(rms)
- Stability with tantalum or ceramic capacitors
- Load independent, ultralow ground current
- 150mA output current
- Current limiting
- Thermal Shutdown
- Tight load and line regulation
- “Zero” off-mode current
- Fast transient response
- TTL-Logic-controlled enable input

Applications

- Cellular phones and pagers
- Cellular accessories
- Battery-powered equipment
- Laptop, notebook, and palmtop computers
- PCMCIA V_{CC} and V_{PP} regulation/switching
- Consumer/personal electronics
- SMPS post-regulator/dc-to-dc modules
- High-efficiency linear power supplies

Ordering Information

Part Number	Marking	Voltage	Junction Temp. Range	Package
MIC5245-2.5BM5	LS25	2.5V	-40°C to +125°C	SOT-23-5
MIC5245-2.7BM5	LS27	2.7V	-40°C to +125°C	SOT-23-5
MIC5245-2.8BM5	LS28	2.8V	-40°C to +125°C	SOT-23-5
MIC5245-2.85BM5	LS2J	2.85V	-40°C to +125°C	SOT-23-5
MIC5245-3.0BM5	LS30	3.0V	-40°C to +125°C	SOT-23-5
MIC5245-3.1BM5	LS31	3.1V	-40°C to +125°C	SOT-23-5
MIC5245-3.2BM5	LS32	3.2V	-40°C to +125°C	SOT-23-5
MIC5245-3.3BM5	LS33	3.3V	-40°C to +125°C	SOT-23-5
MIC5245-3.3BMM	—	3.3V	-40°C to +125°C	MSOP-8

Other voltages available. Contact Micrel for details.

Typical Application

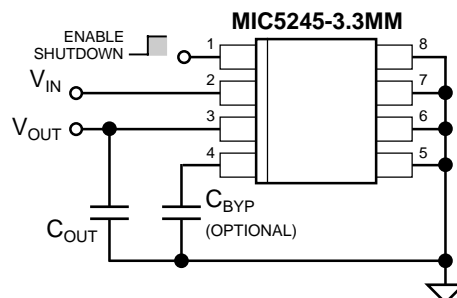
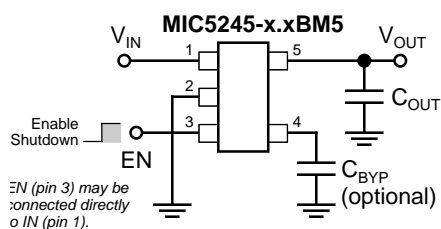

Ultra-Low-Noise Regulator Application

Pin Configuration

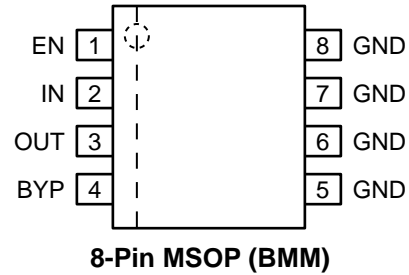
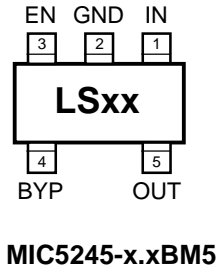

Pin Description

Pin Number Power MOS-8	Pin Number SOT-23	Pin Name	Pin Function
2	1	IN	Supply Input
5–8	2	GND	Ground
1	3	EN	Enable/Shutdown (Input): CMOS compatible input. Logic high = enable; logic low = shutdown. Do not leave open.
4	4	BYP	Reference Bypass: Connect external 0.01 μ F capacitor to GND to reduce output noise. May be left open.
3	5	OUT	Regulator Output

Absolute Maximum Ratings (Note 1)

Supply Input Voltage (V_{IN})	0V to +7V
Enable Input Voltage (V_{EN})	0V to +7V
Junction Temperature (T_J)	+150°C
Storage Temperature	-65°C to +150°C
Lead Temperature (soldering, 5 sec.)	260°C

ESD, Note 3

Operating Ratings (Note 2)

Input Voltage (V_{IN})	+2.7V to +6V
Enable Input Voltage (V_{EN})	0V to V_{IN}
Junction Temperature (T_J)	-40°C to +125°C
Thermal Resistance	
SOT-23 (θ_{JA})	235°C/W
MSOP-8 (θ_{JA})	80°C/W

Electrical Characteristics (Note 7)

$V_{IN} = V_{OUT} + 1V$, $V_{EN} = V_{IN}$; $I_{OUT} = 100\mu A$; $T_J = 25^\circ C$, **bold** values indicate $-40^\circ C \leq T_J \leq +125^\circ C$; unless noted.

Symbol	Parameter	Conditions	Min	Typical	Max	Units
V_O	Output Voltage Accuracy	$I_{OUT} = 0mA$	-1		1	%
			-2		2	%
ΔV_{LNR}	Line Regulation	$V_{IN} = V_{OUT} + 0.1V$ to 6V	-0.3	0	0.3	%/V
ΔV_{LDR}	Load Regulation	$I_{OUT} = 0.1mA$ to 150mA, Note 4		2.0	3.0	%
$V_{IN} - V_{OUT}$	Dropout Voltage, Note 5	$I_{OUT} = 100\mu A$		1.5	5	mV
		$I_{OUT} = 50mA$		50	85	mV
		$I_{OUT} = 100mA$		100	150	mV
		$I_{OUT} = 150mA$		150	200 250	mV mV
I_Q	Quiescent Current	$V_{EN} \leq 0.4V$ (shutdown)		0.2	1	μA
I_{GND}	Ground Pin Current, Note 6	$I_{OUT} = 0mA$		100	150	μA
		$I_{OUT} = 150mA$		100		μA
PSRR	Power Supply Rejection	$f = 120Hz$, $C_{OUT} = 10\mu F$, $C_{BYP} = 0.01\mu F$		50		dB
I_{LIM}	Current Limit	$V_{OUT} = 0V$	160	300		mA
e_n	Output Voltage Noise	$C_{OUT} = 10\mu F$, $C_{BYP} = 0.01\mu F$, $f = 10Hz$ to 100kHz		30		$\mu V(rms)$

Enable Input

V_{IL}	Enable Input Logic-Low Voltage	$V_{IN} = 2.7V$ to 5.5V, regulator shutdown		0.8	0.4	V
V_{IH}	Enable Input Logic-High Voltage	$V_{IN} = 2.7V$ to 5.5V, regulator enabled	2.0	1		V
I_{EN}	Enable Input Current	$V_{IL} \leq 0.4V$		0.17		μA
		$V_{IH} \geq 2.0V$		1.5		μA
	Shutdown Resistance Discharge			500		Ω

Thermal Protection

	Thermal Shutdown Temperature			150		$^\circ C$
	Thermal Shutdown Hysteresis			10		$^\circ C$

Note 1. Exceeding the absolute maximum rating may damage the device.

Note 2. The device is not guaranteed to function outside its operating rating.

Note 3. Devices are ESD sensitive. Handling precautions recommended.

Note 4. Regulation is measured at constant junction temperature using low duty cycle pulse testing. Parts are tested for load regulation in the load range from 0.1mA to 150mA. Changes in output voltage due to heating effects are covered by the thermal regulation specification.

Note 5. Dropout Voltage is defined as the input to output differential at which the output voltage drops 2% below its nominal value measured at 1V differential. For outputs below 2.7V, dropout voltage is the input-to-output voltage differential with the minimum input voltage 2.7V. Minimum input operating voltage is 2.7V.

Note 6. Ground pin current is the regulator quiescent current. The total current drawn from the supply is the sum of the load current plus the ground pin current.

Note 7. Specification for packaged product only.

Typical Characteristics

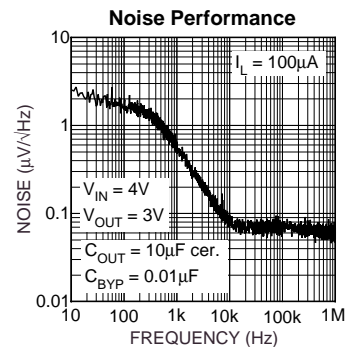
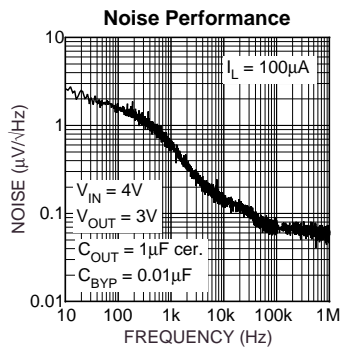
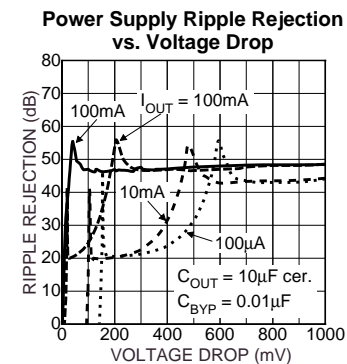
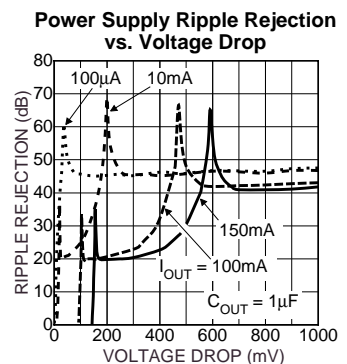
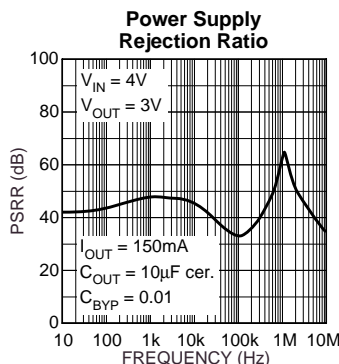
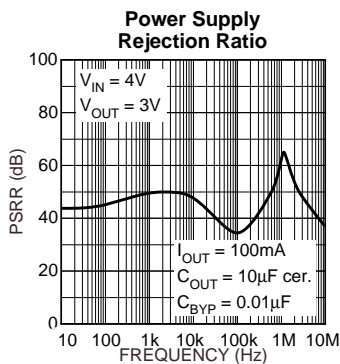
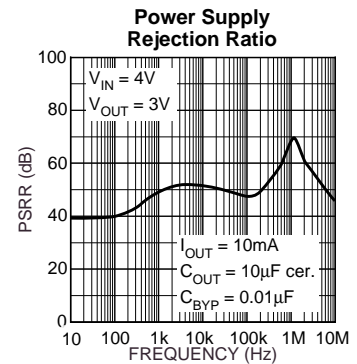
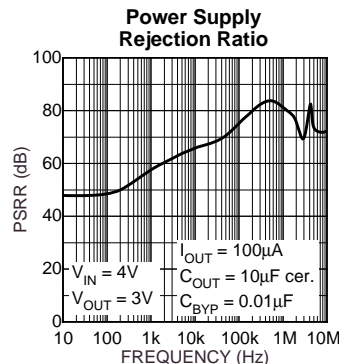
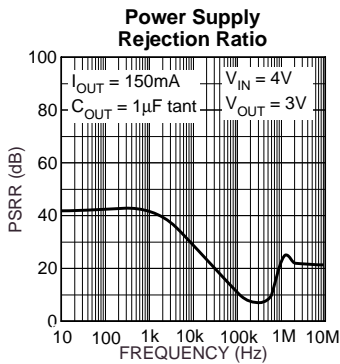
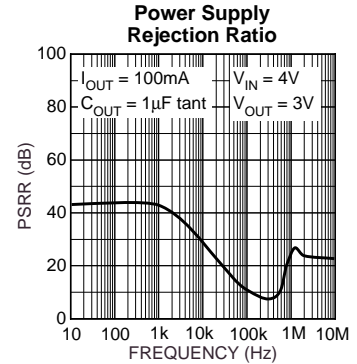
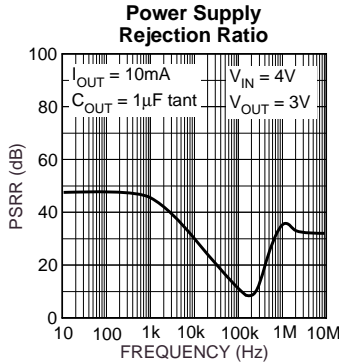
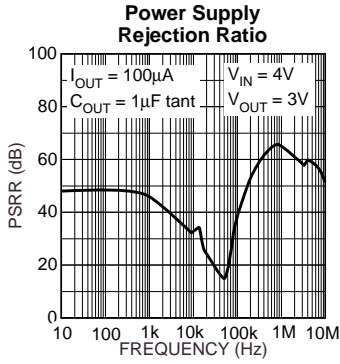

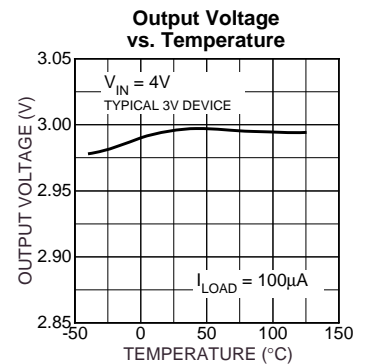
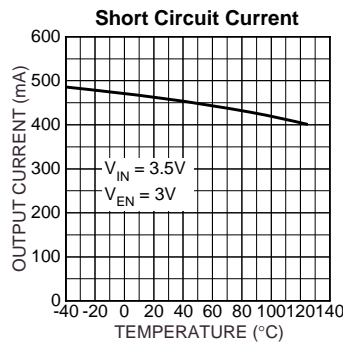
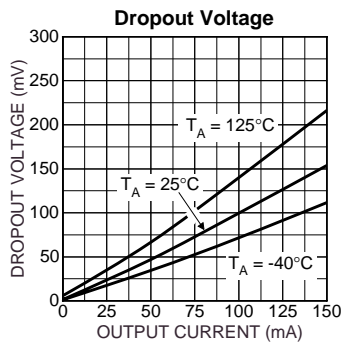
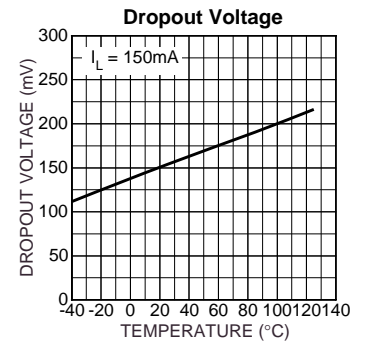
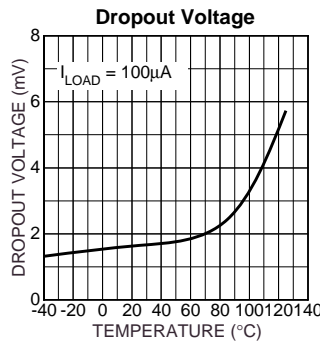
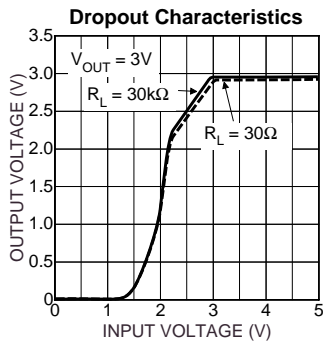
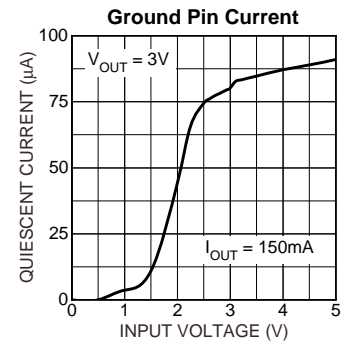
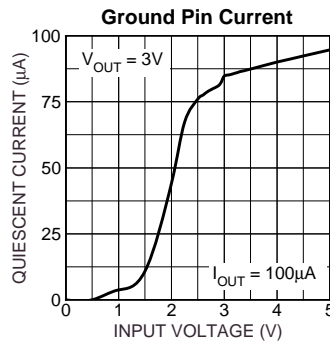
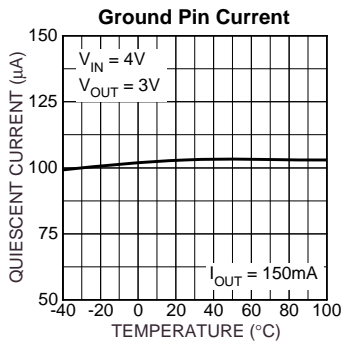
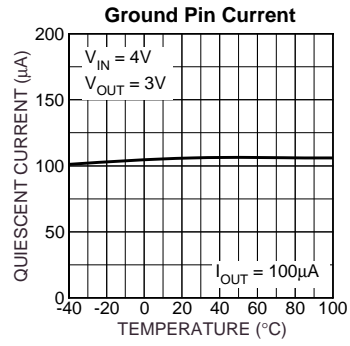
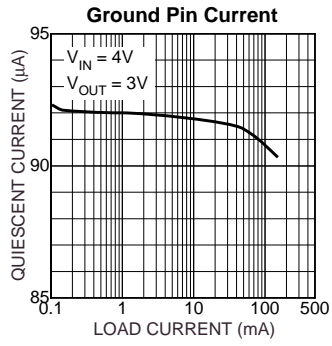

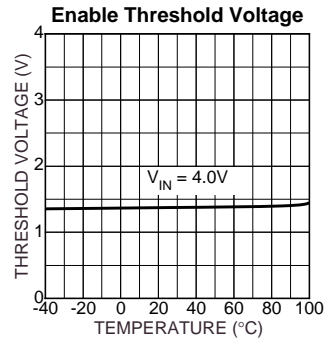
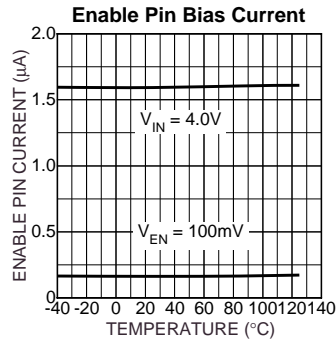

Functional Characteristics

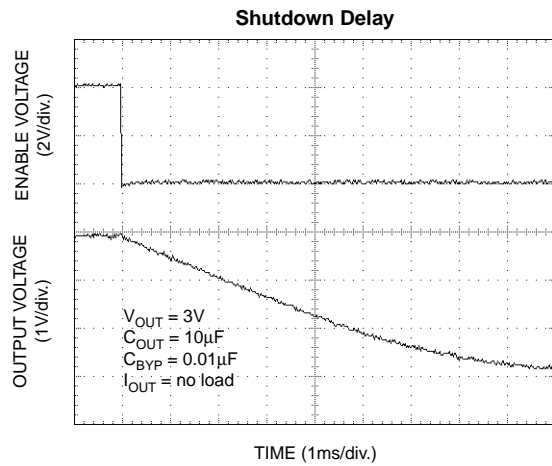
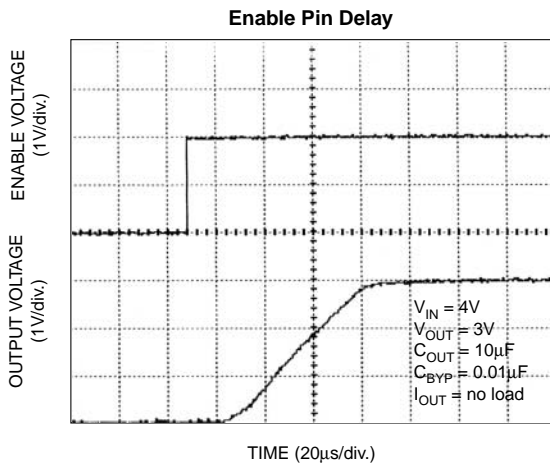
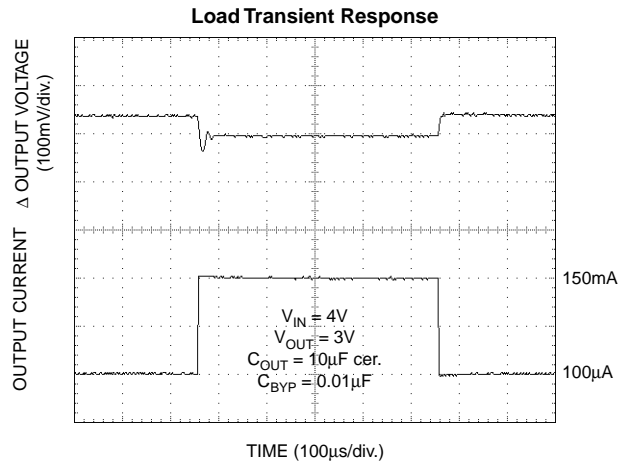
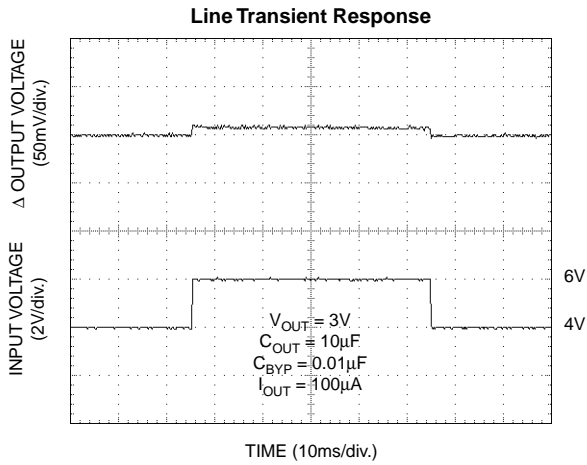

Block Diagrams

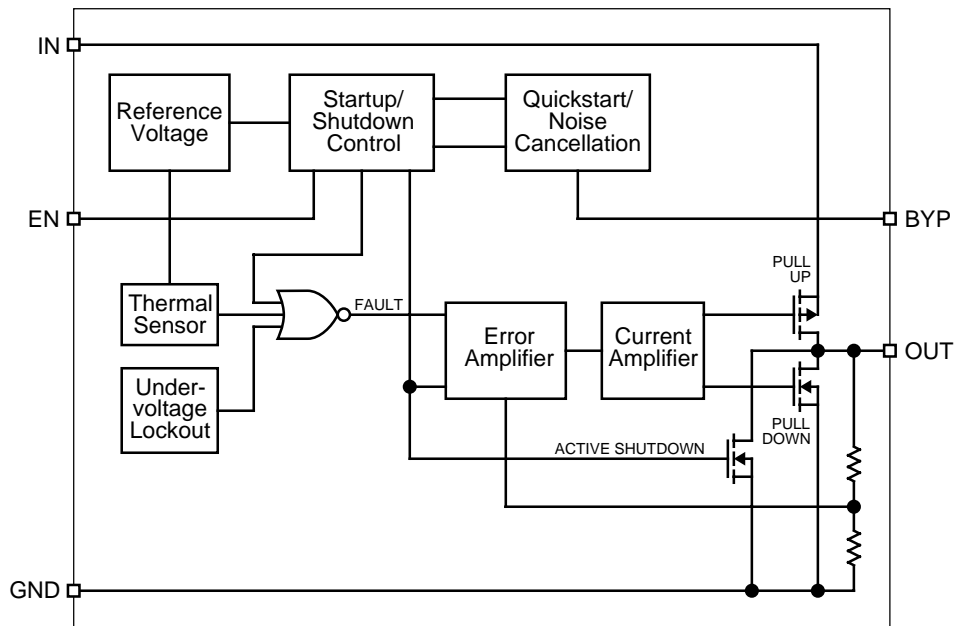

Applications Information

Enable/Shutdown

The MIC5245 comes with an active-high enable pin that allows the regulator to be disabled. Forcing the enable pin low disables the regulator and sends it into a “zero” off-mode-current state. In this state, current consumed by the regulator goes nearly to zero. Forcing the enable pin high enables the output voltage. This part is CMOS and the enable pin cannot be left floating; a floating enable pin may cause an indeterminate state on the output.

Input Capacitor

An input capacitor is not required for stability. A 1 μ F input capacitor is recommended when the bulk ac supply capacitance is more than 10 inches away from the device, or when the supply is a battery.

Output Capacitor

The MIC5245 requires an output capacitor for stability. The design requires 1 μ F or greater on the output to maintain stability. The capacitor can be a low-ESR ceramic chip capacitor. The MIC5245 has been designed to work specifically with the low-cost, small chip capacitors. Tantalum capacitors can also be used for improved capacitance over temperature. The value of the capacitor can be increased without bound.

X7R dielectric ceramic capacitors are recommended because of their temperature performance. X7R-type capacitors change capacitance by 15% over their operating temperature range and are the most stable type of ceramic capacitors. Z5U and Y5V dielectric capacitors change value by as much 50% and 60% respectively over their operating temperature ranges. To use a ceramic chip capacitor with Y5V dielectric, the value must be much higher than an X7R ceramic or a tantalum capacitor to ensure the same minimum capacitance value over the operating temperature range. Tantalum capacitors have a very stable dielectric (10% over their operating temperature range) and can also be used with this device.

Bypass Capacitor

A capacitor can be placed from the noise bypass pin to ground to reduce output voltage noise. The capacitor bypasses the internal reference. A 0.01 μ F capacitor is recommended for applications that require low-noise outputs.

Transient Response

The MIC5245 implements a unique output stage to dramatically improve transient response recovery time. The output is a totem-pole configuration with a P-channel MOSFET pass device and an N-channel MOSFET clamp. The N-channel clamp is a significantly smaller device that prevents the output voltage from overshooting when a heavy load is removed. This feature helps to speed up the transient response by significantly decreasing transient response recovery time during the transition from heavy load (100mA) to light load (100 μ A).

Active Shutdown

The MIC5245 also features an active shutdown clamp, which is an N-channel MOSFET that turns on when the device is disabled. This allows the output capacitor and load to discharge, de-energizing the load.

Thermal Considerations

The MIC5245 is designed to provide 150mA of continuous current in a very small package. Maximum power dissipation can be calculated based on the output current and the voltage drop across the part. To determine the maximum power dissipation of the package, use the junction-to-ambient thermal resistance of the device and the following basic equation:

$$P_{D(\max)} = \left(\frac{T_{J(\max)} - T_A}{\theta_{JA}} \right)$$

$T_{J(\max)}$ is the maximum junction temperature of the die, 125°C, and T_A is the ambient operating temperature. θ_{JA} is layout dependent; Table 1 shows examples of junction-to-ambient thermal resistance for the MIC5245.

Package	θ_{JA} Recommended Minimum Footprint	θ_{JA} 1" Square Copper Clad	θ_{JC}
SOT-23-5 (M5)	235°C/W	185°C/W	145°C/W

Table 1. SOT-23-5 Thermal Resistance

The actual power dissipation of the regulator circuit can be determined using the equation:

$$P_D = (V_{IN} - V_{OUT}) I_{OUT} + V_{IN} I_{GND}$$

Substituting $P_{D(\max)}$ for P_D and solving for the operating conditions that are critical to the application will give the maximum operating conditions for the regulator circuit. For example, when operating the MIC5245-3.3BM5 at 50°C with a minimum footprint layout, the maximum input voltage for a set output current can be determined as follows:

$$P_{D(\max)} = \left(\frac{125^\circ\text{C} - 50^\circ\text{C}}{235^\circ\text{C/W}} \right)$$

$$P_{D(\max)} = 315\text{mW}$$

The junction-to-ambient thermal resistance for the minimum footprint is 235°C/W, from Table 1. The maximum power dissipation must not be exceeded for proper operation. Using the output voltage of 3.3V and an output current of 150mA, the maximum input voltage can be determined. Because this device is CMOS and the ground current is typically 87 μ A over the load range, the power dissipation contributed by the ground current is < 1% and can be ignored for this calculation.

$$315\text{mW} = (V_{IN} - 3.3\text{V}) 150\text{mA}$$

$$315\text{mW} = V_{IN} \times 150\text{mA} - 495\text{mW}$$

$$810\text{mW} = V_{IN} \times 150\text{mA}$$

$$V_{IN(\max)} = 5.4\text{V}$$

Therefore, a 3.3V application at 150mA of output current can accept a maximum input voltage of 5.4V in a SOT-23-5 package. For a full discussion of heat sinking and thermal

effects on voltage regulators, refer to the Regulator Thermals section of Micrel's *Designing with Low-Dropout Voltage Regulators* handbook.

Fixed Regulator Applications

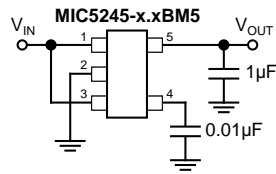

Figure 1. Ultra-Low-Noise Fixed Voltage Application

Figure 1 includes a $0.01\mu\text{F}$ capacitor for low-noise operation and shows EN (pin 3) connected to IN (pin 1) for an application where enable/shutdown is not required. $C_{\text{OUT}} = 1\mu\text{F}$ minimum.

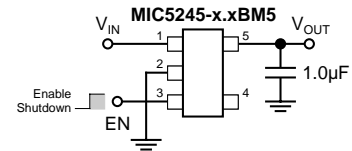

Figure 2. Low-Noise Fixed Voltage Application

Figure 2 is an example of a low-noise configuration where C_{BYP} is not required. $C_{\text{OUT}} = 1\mu\text{F}$ minimum.

Dual-Supply Operation

When used in dual supply systems where the regulator load is returned to a negative supply, the output voltage must be diode clamped to ground.

Package Information

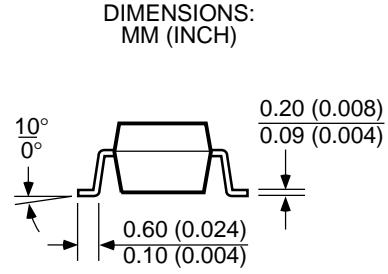
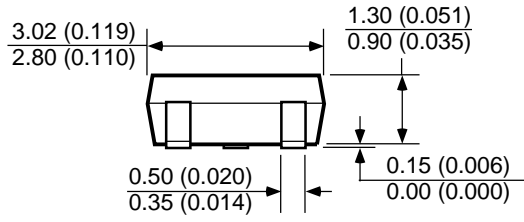
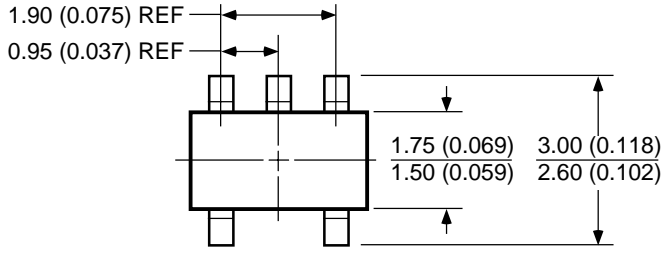

SOT-23-5 (M)

MICREL, INC. 1849 FORTUNE DRIVE SAN JOSE, CA 95131 USA

TEL + 1 (408) 944-0800 FAX + 1 (408) 944-0970 WEB <http://www.micrel.com>

This information is believed to be accurate and reliable, however no responsibility is assumed by Micrel for its use nor for any infringement of patents or other rights of third parties resulting from its use. No license is granted by implication or otherwise under any patent or patent right of Micrel, Inc.

© 2002 Micrel, Incorporated

Looking for pricing, stock, or lifecycle information?

Click below to explore more details on WIN SOURCE:

- ⊖ [View MIC5245-2.8BM5TR on WIN SOURCE](#)
- ⊖ [Microchip Technology](#) Information

Optimize Your Supply Chain with WIN SOURCE Solutions

- ✓ Global Sourcing Solution
- ✓ Obsolete Management
- ✓ Cost Control Management
- ✓ Shortage Management
- ✓ Alternative Solution
- ✓ Excess Inventory Management