



**THE DATASHEET OF
MIC5247-1.85YM5-TR**



General Description

The MIC5247 is an efficient and precise, low-voltage CMOS voltage regulator optimized for ultra-low noise applications. The MIC5247 offers better than 1% initial accuracy and 85 μ A constant ground current over load (typically 85 μ A). The MIC5247 provides a very low-noise output, ideal for RF applications where quiet voltage sources are required. A noise bypass pin is also available for further reduction of output noise.

Designed specifically for handheld and battery-powered devices, the MIC5247 provides a logic compatible enable pin. When disabled, power consumption drops nearly to zero.

The MIC5247 also works with low-ESR ceramic capacitors, reducing the amount of board space necessary for power applications, critical in handheld wireless devices.

Key features include current limit, thermal shutdown, a push-pull output for faster transient response, and an active clamp to speed up device turnoff. Available in the 6-pin 2mm \times 2mm MLF™ package and the IttyBitty® SOT-23-5 package, the MIC5247 also offers a range of fixed output voltages.

All support documentation can be found on Micrel's web site at www.micrel.com.

Features

- Ultra-low noise
- Low-voltage outputs
- Load independent, ultra-low ground current: 85 μ A
- 150mA output current
- Current limiting
- Thermal shutdown
- Tight load and line regulation
- "Zero" off-mode current
- Stability with low-ESR capacitors
- Fast transient response
- Logic-controlled enable input

Applications

- Cellular phones and pagers
- Cellular accessories
- Battery-powered equipment
- Laptop, notebook, and palmtop computers
- PCMCIA V_{CC} and V_{PP} regulation/switching
- Consumer/personal electronics
- SMPS post-regulator/DC-to-DC modules
- High-efficiency linear power supplies

Typical Application

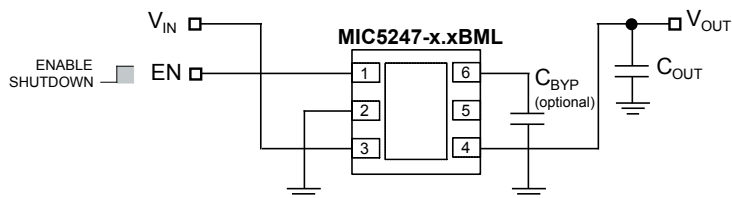
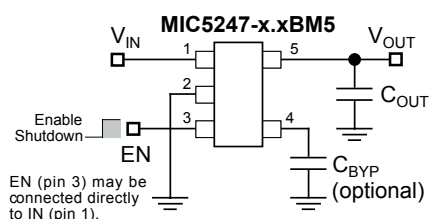

Ultra-Low-Noise Regulator Application

Ordering Information

Part Number				Voltage*	Junction Temp. Range	Package
Standard	Marking	Pb-Free	Marking**			
MIC5247-1.5BM5	LU15	MIC5247-1.5YM5	<u>LU</u> 15	1.5V	-40°C to +125°C	SOT-23-5
MIC5247-1.6BM5	LU16	MIC5247-1.6YM5	<u>LU</u> 16	1.6V	-40°C to +125°C	SOT-23-5
MIC5247-1.8BM5	LU18	MIC5247-1.8YM5	<u>LU</u> 18	1.8V	-40°C to +125°C	SOT-23-5
MIC5247-1.85BM5	LU1J	MIC5247-1.85YM5	<u>LU</u> 1J	1.85V	-40°C to +125°C	SOT-23-5
MIC5247-2.0BM5	LU20	MIC5247-2.0YM5	<u>LU</u> 20	2.0V	-40°C to +125°C	SOT-23-5
MIC5247-2.1BM5	LU21	MIC5247-2.1YM5	<u>LU</u> 21	2.1V	-40°C to +125°C	SOT-23-5
MIC5247-2.2BM5	LU22	MIC5247-2.2YM5	<u>LU</u> 22	2.2V	-40°C to +125°C	SOT-23-5
MIC5247-2.4BM5	LU24	MIC5247-2.4YM5	<u>LU</u> 24	2.4V	-40°C to +125°C	SOT-23-5
MIC5247-1.8BD5	NU18	MIC5247-1.8YD5	<u>NU</u> 18	1.8V	-40°C to +125°C	Thin SOT-23-5
MIC5247-2.0BD5	NU20	MIC5247-2.0YD5	<u>NU</u> 20	2.0V	-40°C to +125°C	Thin SOT-23-5
MIC5247-1.5BML	U15	MIC5247-1.5YML	<u>U</u> 15	1.5V	-40°C to +125°C	6-Pin 2mm x 2mm MLF™
MIC5247-1.6BML	U16	MIC5247-1.6YML	<u>U</u> 16	1.6V	-40°C to +125°C	6-Pin 2mm x 2mm MLF™
MIC5247-1.8BML	U18	MIC5247-1.8YML	<u>U</u> 18	1.8V	-40°C to +125°C	6-Pin 2mm x 2mm MLF™
MIC5247-1.85BML	U1J	MIC5247-1.85YML	<u>U</u> 1J	1.85V	-40°C to +125°C	6-Pin 2mm x 2mm MLF™

* Other voltage options available, please contact Micrel Marketing for details.

** Over and under bar (¯) (⌋) symbols may not be to scale.

Pin Configuration

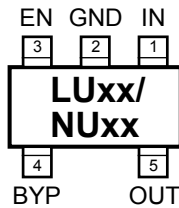

MIC5247-x.xBM5 / YM5
MIC5247-x.xBD5 / YM5
(Top View)

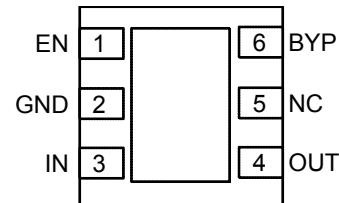

MIC5247-x.xBML / YML
6-Pin 2mm x 2mm MLF™ (ML)
(Top View)

Pin Description

Pin Number SOT-23-5	Pin Number MLF™-6	Pin Name	Pin Function
1	3	IN	Supply input.
2	2	GND	Ground.
3	1	EN	Enable/Shutdown (Input): CMOS-compatible input. Logic high = enable; logic low = shutdown. Do not leave open.
4	6	BYP	Reference bypass: Connect external 0.01pF capacitor to GND to reduce output noise. May be left open.
5	4	OUT	Regulator output.
—	5	NC	No internal connection.
—	EP	GND	Ground. Internally connected to the exposed pad. Connect to ground pin.

Absolute Maximum Ratings⁽¹⁾

Supply Input Voltage (V_{IN})	0V to +7V
Enable Input Voltage (V_{EN})	0V to V_{IN}
Junction Temperature (T_J)	+150°C
Storage Temperature (T_S)	-65°C to +150°C
Lead Temperature (soldering, 5 sec.)	260°C
ESD Rating ⁽³⁾	

Operating Ratings⁽²⁾

Input Voltage (V_{IN})	+2.7V to +6V
Enable Input Voltage (V_{EN})	0V to V_{IN}
Junction Temperature (T_J)	-40°C to +125°C
Package Thermal Resistance	
SOT-23-5 (θ_{JA})	235°C/W
2mm × 2mm MLF™ (θ_{JA})	90°C/W

Electrical Characteristics⁽⁴⁾

$V_{IN} = V_{OUT} + 1.0V$; $V_{IN} = V_{EN}$; $I_{OUT} = 100\mu A$; $T_J = 25^\circ C$, **bold** values indicate $-40^\circ C \leq T_J \leq +125^\circ C$; unless noted.

Symbol	Parameter	Conditions	Min	Typ	Max	Units
V_O	Output Voltage Accuracy	$I_{OUT} = 0mA$	-1		1	%
			-2		2	%
ΔV_{LNR}	Line Regulation	$V_{IN} = 2.7V$ to 6V	-0.3		+0.3	%/V
ΔV_{LDR}	Load Regulation	$I_{OUT} = 0.1mA$ to 150mA ⁽⁵⁾		2	3	%
	Load Regulation for 1.5V and 1.6V	$I_{OUT} = 0.1mA$ to 150mA, $V_{OUT} = 1.5V$ or 1.6V		3	4	%
$V_{IN} - V_{OUT}$	Dropout Voltage	$I_{OUT} = 150mA$ ⁽⁶⁾		150		mV
I_Q	Quiescent Current	$V_{EN} \leq 0.4V$ (shutdown)		0.2	1	μA
I_{GND}	Ground Pin Current ⁽⁷⁾	$I_{OUT} = 0mA$		85	150	μA
		$I_{OUT} = 150mA$		85	150	μA
PSRR	Power Supply Rejection	$f \leq 1kHz$		50		dB
I_{LIM}	Current Limit	$V_{OUT} = 0V$	160	300		mA
e_n	Output Voltage Noise	$C_{OUT} = 10\mu F$, $C_{BYP} = 0.01\mu F$, $f = 10Hz$ to 100kHz		30		μV_{rms}

Enable Input

V_{IL}	Enable Input Logic-Low Voltage	$V_{IN} = 2.7V$ to 5.5V, regulator shutdown		0.8	0.4	V
V_{IH}	Enable Input Logic-High Voltage	$V_{IN} = 2.7V$ to 5.5V, regulator enabled	1.6	1		V
I_{EN}	Enable Input Current	$V_{IL} \leq 0.4V$		0.01		μA
		$V_{IH} \geq 1.6V$		0.01		μA
	Shutdown Resistance Discharge			500		Ω

Thermal Protection

	Thermal Shutdown Temperature			150		°C
	Thermal Shutdown Hysteresis			10		°C

Notes:

- Exceeding the absolute maximum ratings may damage the device.
- The device is not guaranteed to function outside its operating ratings.
- Devices are ESD sensitive. Handling precautions recommended.
- Specification for packaged product only.
- Regulation is measured at constant junction temperature using low duty cycle pulse testing. Parts are tested for load regulation in the load range from 0.1mA to 150mA. Changes in output voltage due to heating effects are covered by the thermal regulation specification.
- Dropout voltage is defined as the input-to-output differential at which the output voltage drops 2% below its nominal value measured a1V differential. For outputs below 2.7V, dropout voltage is the input-to-output voltage differential with the minimum input voltage 2.7V. Minimum input operating voltage is 2.7V.
- Ground pin current is the regulator quiescent current plus pass transistor base current. The total current drawn from the supply is the sum of the load current plus the ground pin current.

Typical Characteristics

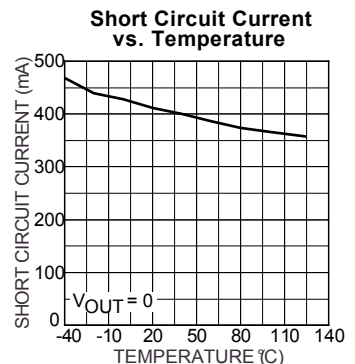
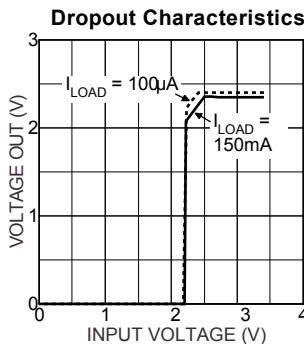
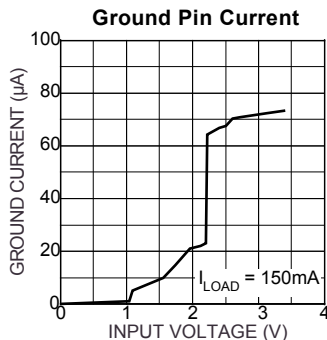
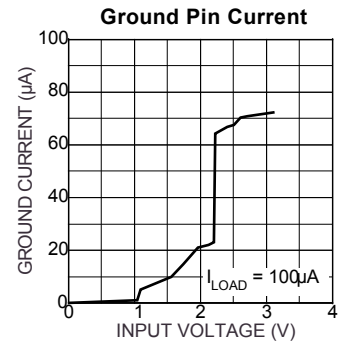
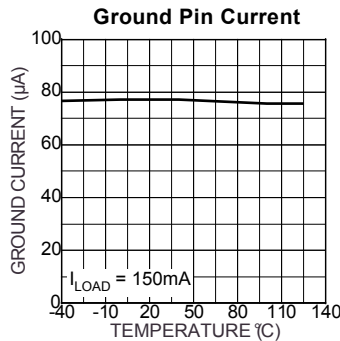
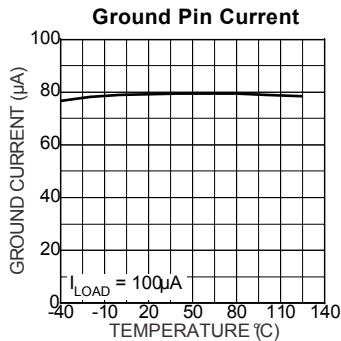
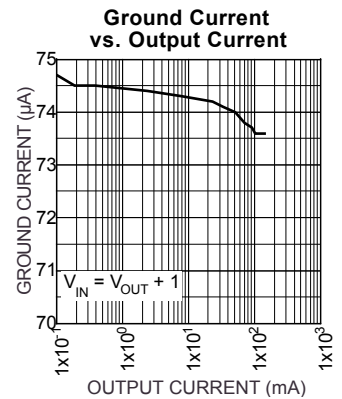
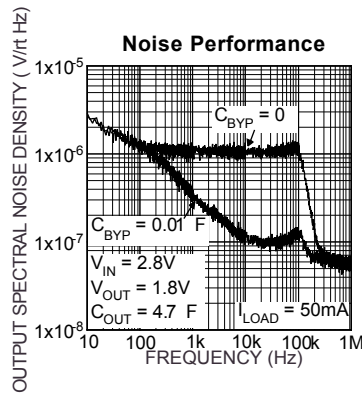
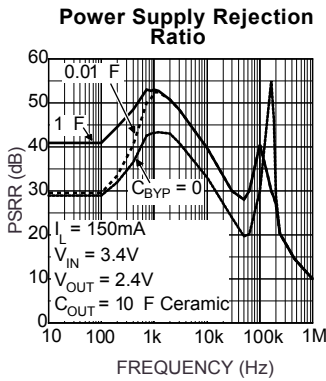
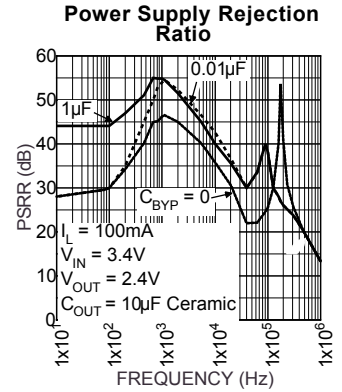
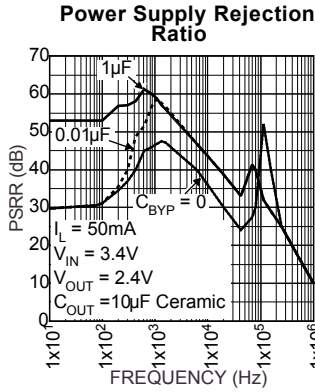
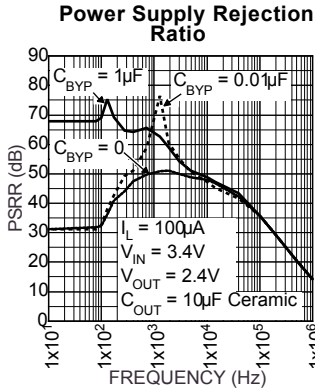

Typical Characteristics, cont.

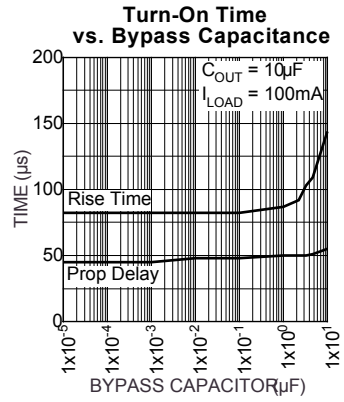
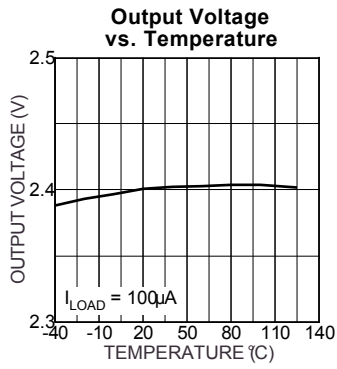

Functional Characteristics

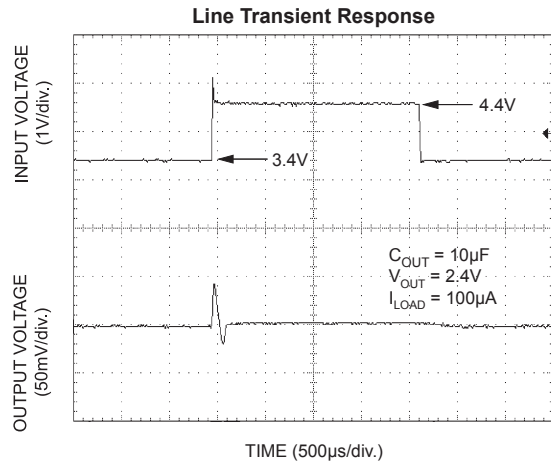
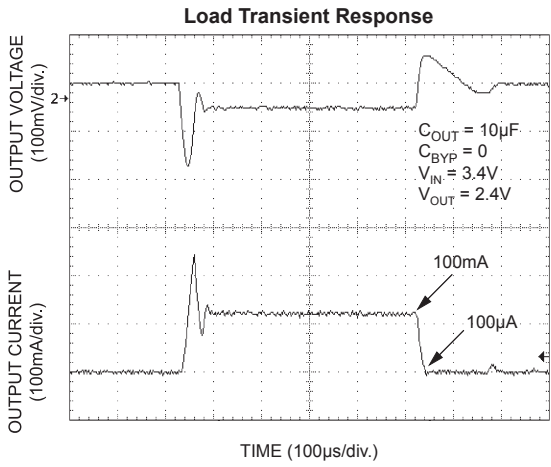

Block Diagram

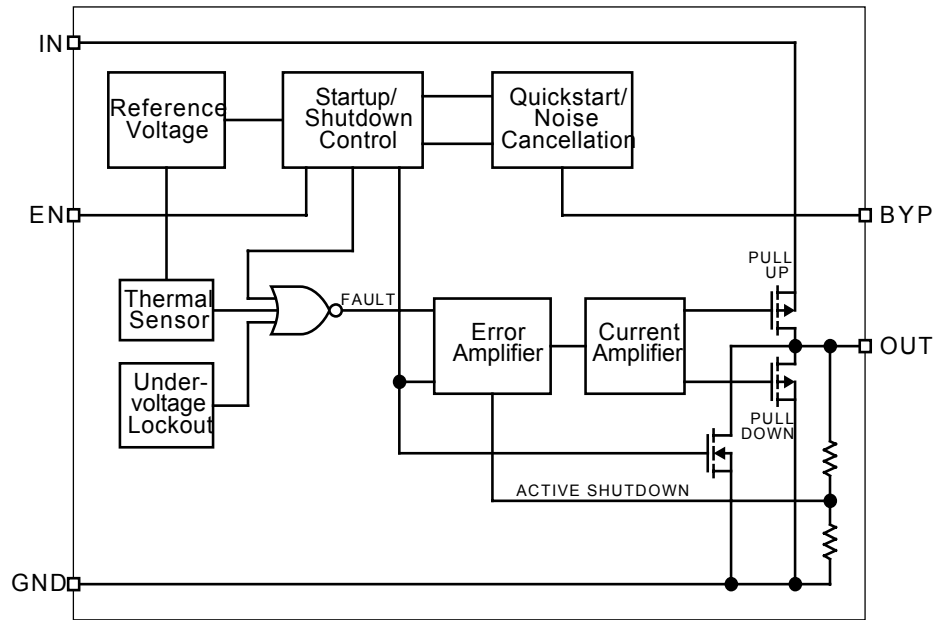

Applications Information

Enable/Shutdown

The MIC5247 comes with an active-high enable pin that can disable the regulator. Forcing the enable pin low disables the regulator and sends it into a “zero” off-mode-current state. In this state, current consumed by the regulator goes nearly to zero. Forcing the enable pin high enables the output voltage. This part is CMOS and the enable pin cannot be left floating; a floating enable pin may cause an indeterminate state on the output.

Input Capacitor

An input capacitor is not required for stability. A 1 μ F input capacitor is recommended when the bulk AC supply capacitance is more than 10 inches away from the device, or when the supply is a battery.

Output Capacitor

The MIC5247 requires an output capacitor for stability. The design requires 1 μ F or greater on the output to maintain stability. The capacitor can be a low-ESR ceramic chip capacitor. The MIC5247 has been designed to work specifically with low-cost, small chip capacitors. Tantalum capacitors can also be used for improved capacitance over temperature. The value of the capacitor can be increased without bound.

Bypass Capacitor

A capacitor can be placed from the noise bypass pin to ground to reduce output voltage noise. The capacitor bypasses the internal reference. A 0.01 μ F capacitor is recommended for applications that require low-noise outputs.

The bypass capacitor can be increased without bound, further reducing noise and improving PSRR. Turn-on time remains constant with respect to bypass capacitance. Refer to the “Typical Characteristics” section for a graph of turn-on time vs. bypass capacitor.

Transient Response

The MIC5247 implements a unique output stage to dramatically improve transient response recovery time. The output is a totem-pole configuration with a P-Channel MOSFET pass device and an N-Channel MOSFET clamp. The N-Channel clamp is a significantly smaller device that prevents the output voltage from overshooting when a heavy load is removed. This feature helps to speed up the transient response by significantly decreasing transient response recovery time during the transition from heavy load (100mA) to light load (85 μ A).

Active Shutdown

The MIC5247 also features an active shutdown clamp, which is an N-Channel MOSFET that turns on when the device is disabled. This allows the output capacitor and load to discharge, de-energizing the load.

Thermal Considerations

The MIC5247 is designed to provide 150mA of continuous current in a very small package. Maximum power dissipation can be calculated based on the output current and the voltage drop across the part. To determine the maximum power dissipation of the package, use the junction-to-ambient thermal

resistance of the device and the following basic equation:

$$P_D(\max) = \left(\frac{T_J(\max) - T_A}{\theta_{JA}} \right)$$

$T_J(\max)$ is the maximum junction temperature of the die, 125°C, and T_A is the ambient operating temperature. θ_{JA} is layout dependent; Table 1 shows examples of junction-to-ambient thermal resistance for the MIC5247.

Package	θ_{JA} Recommended Minimum Footprint	θ_{JA} 1" Square Copper Clad	θ_{JC}
SOT-23-5 (M5)	235°C/W	185°C/W	145°C/W

Table 1. SOT-23-5 Thermal Resistance

The actual power dissipation of the regulator circuit can be determined using the equation:

$$P_D = (V_{IN} - V_{OUT}) \times I_{OUT} + V_{IN} \times I_{GND}$$

Substituting $P_D(\max)$ for P_D and solving for the operating conditions that are critical to the application will give the maximum operating conditions for the regulator circuit. For example, when operating the MIC5247-2.4BM5 at room temperature with a minimum footprint layout, the maximum input voltage for a set output current can be determined as follows:

$$P_D(\max) = \left(\frac{125^\circ\text{C} - 25^\circ\text{C}}{235^\circ\text{C/W}} \right)$$

$$P_D(\max) = 425\text{mW}$$

The junction-to-ambient thermal resistance for the minimum footprint is 235°C/W, from Table 1. The maximum power dissipation must not be exceeded for proper operation. Using the output voltage of 2.4V and an output current of 150mA, the maximum input voltage can be determined. Because this device is CMOS and the ground current is typically 100 μ A over the load range, the power dissipation contributed by the ground current is < 1% and can be ignored for this calculation.

$$425\text{mW} = (V_{IN} - 2.4\text{V}) 150\text{mA}$$

$$425\text{mW} = V_{IN} \times 150\text{mA} - 360\text{mW}$$

$$785\text{mW} = V_{IN} \times 150\text{mA}$$

$$V_{IN}(\max) = 5.2\text{V}$$

Therefore, a 2.4V application at 150mA of output current can accept a maximum input voltage of 5.2V in a SOT-23-5 package. For a full discussion of heat sinking and thermal effects on voltage regulators, refer to the “Regulator Thermals” section of *Micrel’s Designing with Low-Dropout Voltage Regulators* handbook.

Fixed Regulator Applications

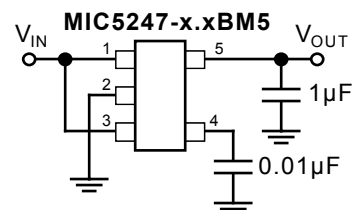

Figure 1. Ultra-Low-Noise Fixed Voltage Application

Figure 1 includes a $0.01\mu\text{F}$ capacitor for low-noise operation and shows EN (pin 3) connected to IN (pin 1) for an application where enable/shutdown is not required. $C_{\text{OUT}} = 1\mu\text{F}$ minimum.

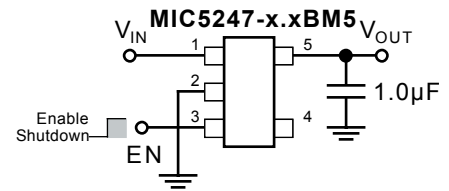
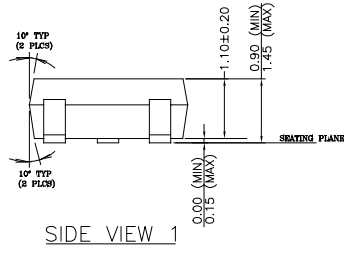
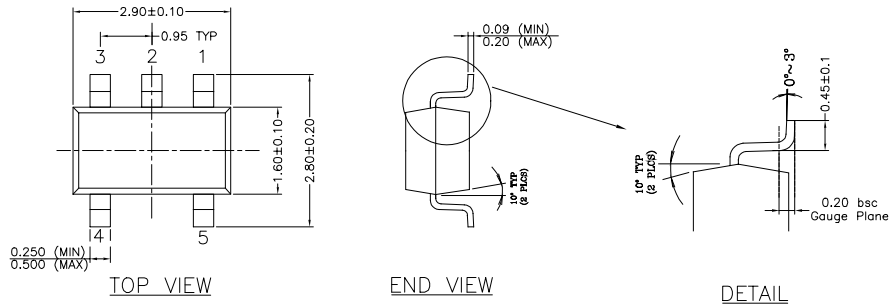

Figure 2. Low-Noise Fixed Voltage Application

Figure 2 is an example of a low-noise configuration where C_{BYP} is not required. $C_{\text{OUT}} = 1\mu\text{F}$ minimum.

Package Information



- NOTE:
1. PACKAGE OUTLINE EXCLUSIVE OF MOLD FLASH & BURR.
 2. PACKAGE OUTLINE INCLUSIVE OF SOLER PLATING.
 3. DIMENSION AND TOLERANCE PER ANSI Y14.5M, 1982.
 4. FOOT LENGTH MEASUREMENT BASED ON GAUGE PLANE METHOD.
 5. DIE FACES UP FOR MOLD, AND FACES DOWN FOR TRIM/FORM.

SOT-23-5 (M)

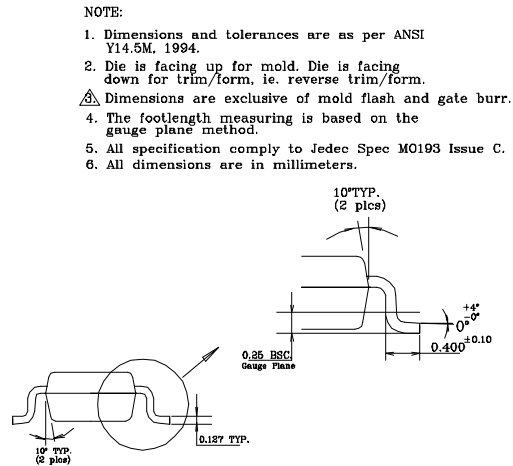
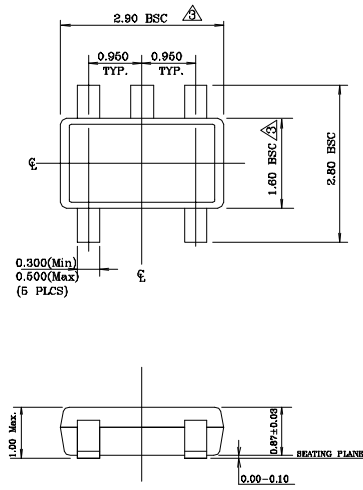

- NOTE:
1. Dimensions and tolerances are as per ANSI Y14.5M, 1994.
 2. Die is facing up for mold. Die is facing down for trim/form, ie. reverse trim/form.
 3. Dimensions are exclusive of mold flash and gate burr.
 4. The footlength measuring is based on the gauge plane method.
 5. All specification comply to Jeduc Spec MO193 Issue C.
 6. All dimensions are in millimeters.

TSOT-23-5 (D5)

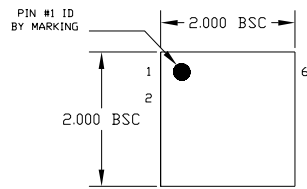

TOP VIEW

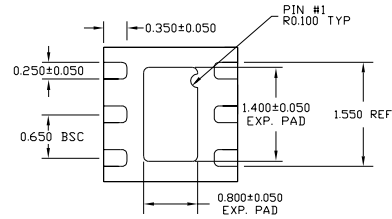

BOTTOM VIEW

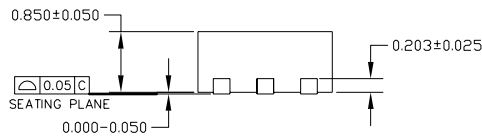

SIDE VIEW

- NOTE:
1. ALL DIMENSIONS ARE IN MILLIMETERS.
 2. MAX. PACKAGE WARPAGE IS 0.05 mm.
 3. MAXIMUM ALLOWABLE BURRS IS 0.076 mm IN ALL DIRECTIONS.
 4. PIN #1 ID ON TOP WILL BE LASER MARKED.

6-Pin MLF™ (ML)

MICREL, INC. 1849 FORTUNE DRIVE SAN JOSE, CA 95131 USA

TEL + 1 (408) 944-0800 FAX + 1 (408) 944-0970 WEB <http://www.micrel.com>

The information furnished by Micrel in this data sheet is believed to be accurate and reliable. However, no responsibility is assumed by Micrel for its use. Micrel reserves the right to change circuitry and specifications at any time without notification to the customer.

Micrel Products are not designed or authorized for use as components in life support appliances, devices or systems where malfunction of a product can reasonably be expected to result in personal injury. Life support devices or systems are devices or systems that (a) are intended for surgical implant into the body or (b) support or sustain life, and whose failure to perform can be reasonably expected to result in a significant injury to the user. A Purchaser's use or sale of Micrel Products for use in life support appliances, devices or systems is at Purchaser's own risk and Purchaser agrees to fully indemnify Micrel for any damages resulting from such use or sale.

© 2004 Micrel, Incorporated.

Looking for pricing, stock, or lifecycle information?

Click below to explore more details on WIN SOURCE:

- ⊖ [View MIC5247-1.85YM5-TR on WIN SOURCE](#)
- ⊖ [Microchip Technology](#) Information

Optimize Your Supply Chain with WIN SOURCE Solutions

- ✓ Global Sourcing Solution
- ✓ Obsolete Management
- ✓ Cost Control Management
- ✓ Shortage Management
- ✓ Alternative Solution
- ✓ Excess Inventory Management