



**THE DATASHEET OF  
MIC5252-2.85YML-TR**



### General Description

The MIC5252 is an efficient, precise CMOS voltage regulator optimized for ultra-low-noise applications. It offers 1% initial accuracy, extremely-low dropout voltage (135mV at 150mA) and low ground current (typically 90 $\mu$ A). The MIC5252 provides a very-low-noise output, ideal for RF applications where a clean voltage source is required. The MIC5252 has a high PSRR even at low supply voltages, critical for battery operated electronics. A noise bypass pin is also available for further reduction of output noise.

Designed specifically for handheld and battery-powered devices, the MIC5252 provides a TTL-logic-compatible enable pin. When disabled, power consumption drops nearly to zero.

The MIC5252 also works with low-ESR ceramic capacitors, reducing the amount of board space necessary for power applications, critical in handheld wireless devices.

Key features include current limit, thermal shutdown, faster transient response, and an active clamp to speed up device turn-off. The MIC5252 is available in the 6-pin 2mm  $\times$  2mm MLF™ package and the IttyBitty® SOT-23-5 package in a wide range of output voltages.

### Features

- Input voltage range: 2.7V to 6.0V
- PSRR = 50dB @  $V_O + 0.3V$
- Ultra-low output noise: 30 $\mu$ V(rms)
- Stability with ceramic output capacitors
- Ultra-low dropout: 135mV @ 150mA
- High output accuracy:
  - 1.0% initial accuracy
  - 2.0% over temperature
- Low quiescent current: 90 $\mu$ A
- Tight load and line regulation
- TTL-Logic-controlled enable input
- “Zero” off-mode current
- Thermal shutdown and current limit protection

### Applications

- Cellular phones and pagers
- Cellular accessories
- Battery-powered equipment
- Laptop, notebook, and palmtop computers
- Consumer/personal electronics

### Typical Application

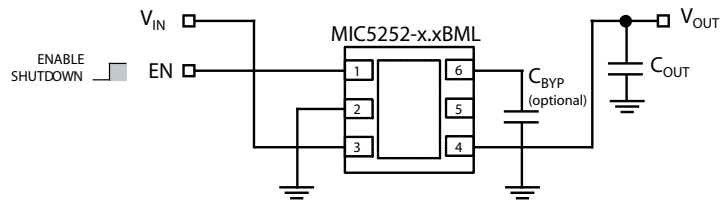
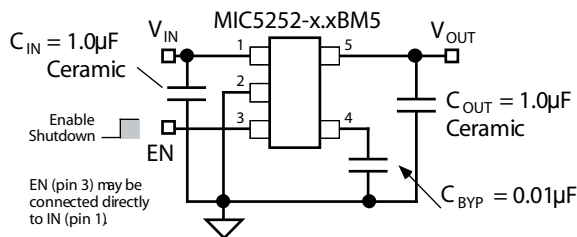

Ultra-Low-Noise Regulator Application

## Ordering Information

| Part Number     |                 | Marking  |              | Voltage | Junction Temp. Range | Package        |
|-----------------|-----------------|----------|--------------|---------|----------------------|----------------|
| Standard        | Pb-Free         | Standard | Pb-Free      |         |                      |                |
| MIC5252-1.8BM5  | MIC5252-1.8YM5  | L618     | <u>L</u> 618 | 1.8V    | -40°C to +125°C      | SOT-23-5       |
| MIC5252-2.5BM5  | MIC5252-2.5YM5  | L625     | <u>L</u> 625 | 2.5V    | -40°C to +125°C      | SOT-23-5       |
| MIC5252-2.8BM5  | MIC5252-2.8YM5  | L628     | <u>L</u> 628 | 2.8V    | -40°C to +125°C      | SOT-23-5       |
| MIC5252-2.85BM5 | MIC5252-2.85YM5 | L62J     | <u>L</u> 62J | 2.85V   | -40°C to +125°C      | SOT-23-5       |
| MIC5252-3.0BM5  | MIC5252-3.0YM5  | L630     | <u>L</u> 630 | 3.0V    | -40°C to +125°C      | SOT-23-5       |
| MIC5252-4.75BM5 | MIC5252-4.75YM5 | L64H     | <u>L</u> 64H | 4.75V   | -40°C to +125°C      | SOT-23-5       |
| MIC5252-2.8BML  | MIC5252-2.8YML  | 628      | <u>6</u> 28  | 2.8V    | -40°C to +125°C      | 6-Pin 2x2 MLF™ |
| MIC5252-2.85BML | MIC5252-2.85YML | 62J      | <u>6</u> 2J  | 2.85V   | -40°C to +125°C      | 6-Pin 2x2 MLF™ |
| MIC5252-3.0BML  | MIC5252-3.0YML  | 630      | <u>6</u> 30  | 3.0V    | -40°C to +125°C      | 6-Pin 2x2 MLF™ |

Other voltages available. Contact Micrel for details.

## Pin Configuration

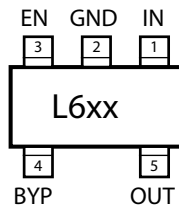

**MIC5252-x.xBM5**  
SOT-23-5 (M5)  
(Top View)

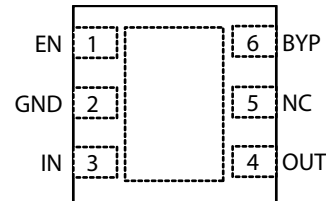

**MIC5252-x.xBML**  
6-Pin 2mm × 2mm MLF™ (ML)  
(Top View)

## Pin Description

| Pin Number<br>SOT-23-5 | Pin Number<br>6-MLF™ | Pin Name | Pin Function  |
|------------------------|----------------------|----------|---|
| 1                      | 3                    | IN       | Supply Input.   |
| 2                      | 2                    | GND      | Ground.   |
| 3                      | 1                    | EN       | Enable/Shutdown (Input): CMOS compatible input. Logic high = enable; logic low = shutdown. Do not leave open.                   |
| 4                      | 6                    | BYP      | Reference Bypass: Connect external 0.01μF ≤ C <sub>BYP</sub> ≤ 1.0μF capacitor to GND to reduce output noise. May be left open. |
| 5                      | 4                    | OUT      | Regulator Output.   |
| –                      | 5                    | NC       | No internal connection.   |
| –                      | EP                   | GND      | Ground: Internally connected to the exposed pad. Connect externally to GND pin.   |

**Absolute Maximum Ratings<sup>(1)</sup>**

|   |                                   |
|---|-----------------------------------|
| Supply Input Voltage ( $V_{IN}$ ).....    | 0V to +7V                         |
| Enable Input Voltage ( $V_{EN}$ ) .....   | 0V to +7V                         |
| Power Dissipation ( $P_D$ ).....          | Internally Limited <sup>(3)</sup> |
| Junction Temperature ( $T_J$ ).....       | -40°C to +125°C                   |
| Storage Temperature.....                  | -65°C to +150°C                   |
| Lead Temperature (soldering, 5 sec.)..... | 260°C                             |
| ESD <sup>(4)</sup> .....                  | 2kV                               |

**Operating Ratings<sup>(2)</sup>**

|   |                 |
|---|-----------------|
| Input Voltage ( $V_{IN}$ ).....               | +2.7V to +6V    |
| Enable Input Voltage ( $V_{EN}$ ) .....       | 0V to $V_{IN}$  |
| Junction Temperature ( $T_J$ ).....           | -40°C to +125°C |
| Thermal Resistance                            |                 |
| SOT-23 ( $\theta_{JA}$ ).....                 | 235°C/W         |
| 2x2 MLF <sup>TM</sup> ( $\theta_{JA}$ ) ..... | 90°C/W          |

**Electrical Characteristics<sup>(5)</sup>**

$V_{IN} = V_{OUT} + 1V$ ,  $V_{EN} = V_{IN}$ ;  $I_{OUT} = 100\mu A$ ;  $T_J = 25^\circ C$ , **bold** values indicate  $-40^\circ C \leq T_J \leq +125^\circ C$ ; unless noted.

| Symbol                | Parameter                           | Conditions   | Min             | Typical | Max               | Units    |
|-----------------------|-------------------------------------|--|-----------------|---------|-------------------|----------|
| $V_O$                 | Output Voltage Accuracy             | $I_{OUT} = 100\mu A$   | -1<br><b>-3</b> |         | 1<br><b>3</b>     | %<br>%   |
| $\Delta V_{LNR}$      | Line Regulation                     | $V_{IN} = V_{OUT} + 1V$ to 6V  |                 | 0.02    | 0.2               | %        |
| $\Delta V_{LDR}$      | Load Regulation                     | $I_{OUT} = 0.1mA$ to 150mA <sup>(6)</sup>                              |                 | 0.6     | <b>1.5</b>        | %        |
| $V_{IN} - V_{OUT}$    | Dropout Voltage <sup>(7)</sup>      | $I_{OUT} = 100\mu A$   |                 | 0.1     | 5                 | mV       |
|                       |                                     | $I_{OUT} = 100mA$  |                 | 90      | 150               | mV       |
|                       |                                     | $I_{OUT} = 150mA$  |                 | 135     | 200<br><b>250</b> | mV<br>mV |
| $I_Q$                 | Quiescent Current                   | $V_{EN} \leq 0.4V$ (shutdown)  |                 | 0.2     | <b>1</b>          | $\mu A$  |
| $I_{GND}$             | Ground Pin Current <sup>(8)</sup>   | $I_{OUT} = 0mA$  |                 | 90      | <b>150</b>        | $\mu A$  |
|                       |                                     | $I_{OUT} = 150mA$  |                 | 117     | <b>200</b>        | $\mu A$  |
| PSRR                  | Ripple Rejection; $I_{OUT} = 150mA$ | $f = 10Hz$ , $C_{OUT} = 1.0\mu F$ , $C_{BYP} = 0.01\mu F$              |                 | 63      |                   | dB       |
|                       |                                     | $f = 10Hz$ , $V_{IN} = V_{OUT} + 0.3V$                                 |                 | 48      |                   | dB       |
|                       |                                     | $f = 10kHz$ , $V_{IN} = V_{OUT} + 0.3V$                                |                 | 48      |                   | dB       |
| $I_{LIM}$             | Current Limit                       | $V_{OUT} = 0V$   | 250             | 425     |                   | mA       |
| $e_n$<br>$\mu V(rms)$ | Output Voltage Noise                | $C_{OUT} = 1.0\mu F$ , $C_{BYP} = 0.01\mu F$ ,<br>$f = 10Hz$ to 100kHz |                 | 30      |                   |          |

**Enable Input**

|          |                                 |   |            |      |            |          |
|----------|---------------------------------|---|------------|------|------------|----------|
| $V_{IL}$ | Enable Input Logic-Low Voltage  | $V_{IN} = 2.7V$ to 5.5V, regulator shutdown |            |      | <b>0.4</b> | V        |
| $V_{IH}$ | Enable Input Logic-High Voltage | $V_{IN} = 2.7V$ to 5.5V, regulator enabled  | <b>1.6</b> |      |            | V        |
| $I_{EN}$ | Enable Input Current            | $V_{IL} \leq 0.4V$ , regulator shutdown     |            | 0.01 | <b>1</b>   | $\mu A$  |
|          |                                 | $V_{IH} \geq 1.6V$ , regulator enabled      |            | 0.01 | <b>1</b>   | $\mu A$  |
|          | Shutdown Resistance Discharge   |   |            | 500  |            | $\Omega$ |

**Thermal Protection**

|  |                              |  |  |     |  |            |
|--|------------------------------|--|--|-----|--|------------|
|  | Thermal Shutdown Temperature |  |  | 150 |  | $^\circ C$ |
|  | Thermal Shutdown Hysteresis  |  |  | 10  |  | $^\circ C$ |

**Notes:**

- Exceeding the absolute maximum rating may damage the device.
- The device is not guaranteed to function outside its operating rating.
- The maximum allowable power dissipation of any  $T_A$  (ambient temperature) is  $P_D(max) = (T_J(max) - T_A) / \theta_{JA}$ . Exceeding the maximum allowable power dissipation will result in excessive die temperature, and the regulator will go into thermal shutdown. The  $\theta_{JA}$  of the MIC5252-x.xBM5 (all versions) is 235°C/W on a PC board. See "Thermal Considerations" section for further details.
- Devices are ESD sensitive. Handling precautions recommended.
- Specification for packaged product only.
- Regulation is measured at constant junction temperature using low duty cycle pulse testing. Parts are tested for load regulation in the load range from 0.1mA to 150mA. Changes in output voltage due to heating effects are covered by the thermal regulation specification.
- Dropout Voltage is defined as the input-to-output differential at which the output voltage drops 2% below its nominal value measured at 1V differential. For outputs below 2.7V, dropout voltage is the input-to-output voltage differential with the minimum input voltage 2.7V. Minimum input operating voltage is 2.7V.
- Ground pin current is the regulator quiescent current. The total current drawn from the supply is the sum of the load current plus the ground pin current.

# Typical Characteristics

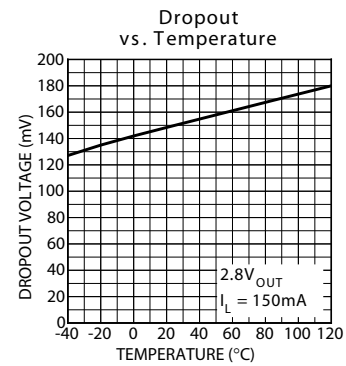
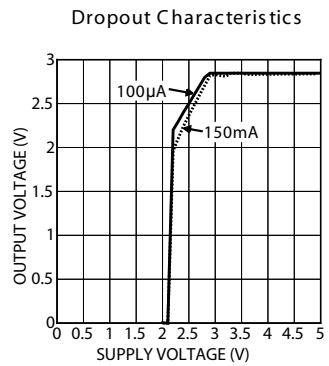
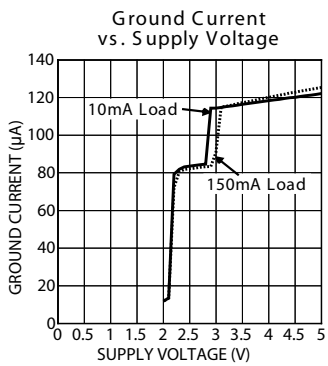
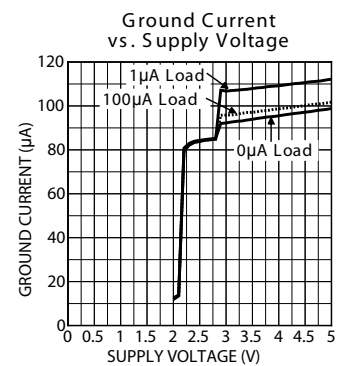
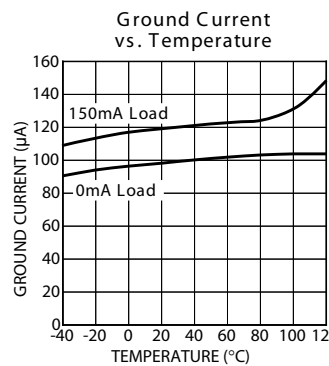
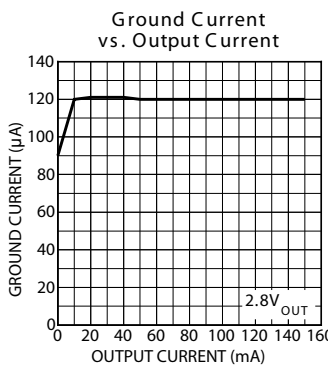
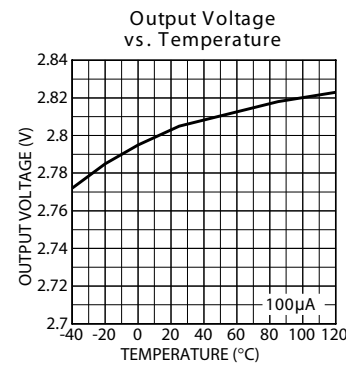
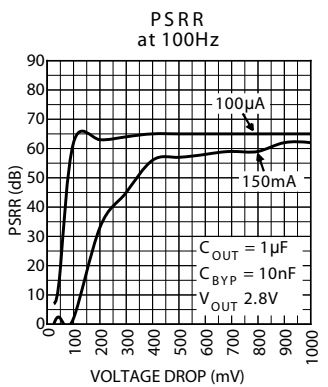
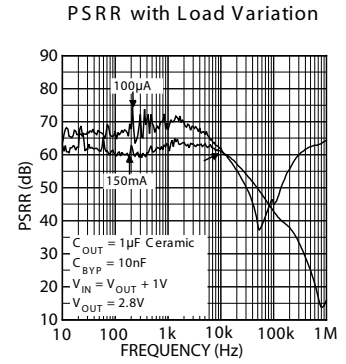
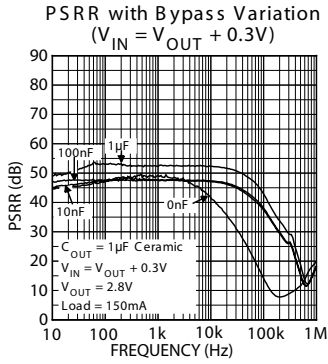

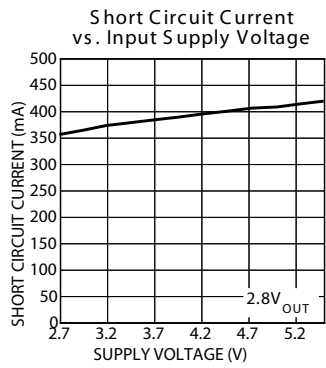
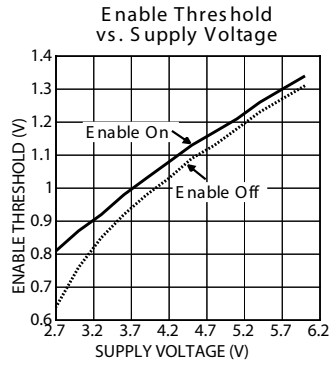
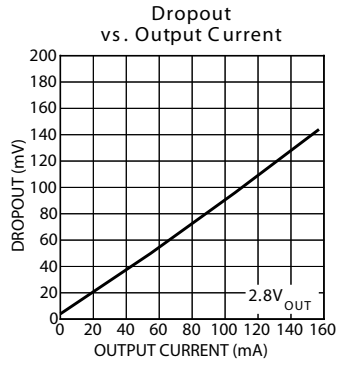

# Functional Characteristics

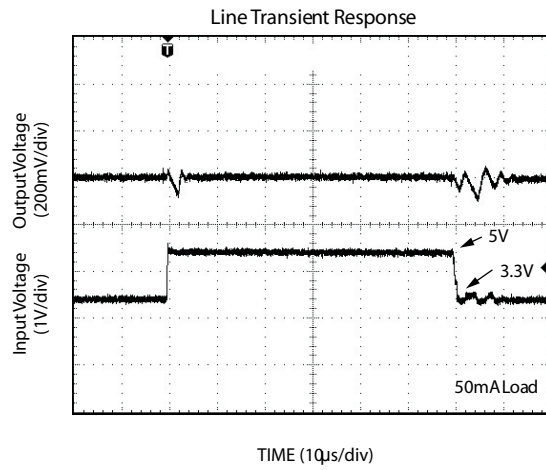
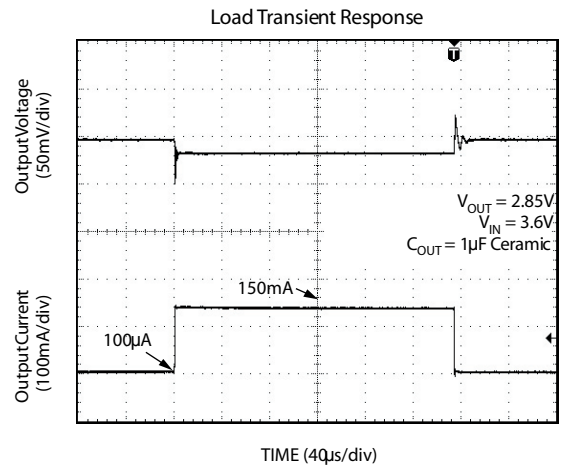

# Block Diagram

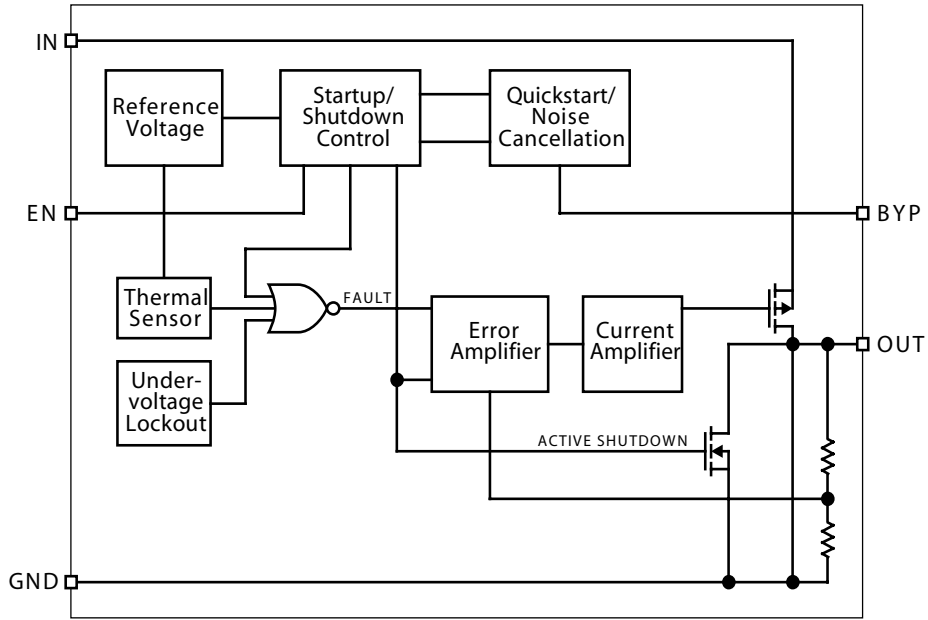

## Applications Information

### Enable/Shutdown

The MIC5252 comes with an active-high enable pin that allows the regulator to be disabled. Forcing the enable pin low disables the regulator and sends it into a “zero” off-mode-current state. In this state, current consumed by the regulator goes nearly to zero. Forcing the enable pin high enables the output voltage. This part is CMOS and the enable pin cannot be left floating; a floating enable pin may cause an indeterminate state on the output.

### Input Capacitor

The MIC5252 is a high performance, high bandwidth device. Therefore, it requires a well-bypassed input supply for optimal performance. A 1 $\mu$ F capacitor is required from the input to ground to provide stability. Low-ESR ceramic capacitors provide optimal performance at a minimum of space. Additional high-frequency capacitors, such as small valued NPO dielectric type capacitors, help filter out high frequency noise and are good practice in any RF based circuit.

### Output Capacitor

The MIC5252 requires an output capacitor for stability. The design requires 1 $\mu$ F or greater on the output to maintain stability. The design is optimized for use with low-ESR ceramic chip capacitors. High ESR capacitors may cause high frequency oscillation. The maximum recommended ESR is 300m $\Omega$ . The output capacitor can be increased, but performance has been optimized for a 1 $\mu$ F ceramic output capacitor and does not improve significantly with larger capacitance.

X7R/X5R dielectric-type ceramic capacitors are recommended because of their temperature performance. X7R-type capacitors change capacitance by 15% over their operating temperature range and are the most stable type of ceramic capacitors. Z5U and Y5V dielectric capacitors change value by as much as 50% and 60%, respectively, over their operating temperature ranges. To use a ceramic chip capacitor with Y5V dielectric, the value must be much higher than an X7R ceramic capacitor to ensure the same minimum capacitance over the equivalent operating temperature range.

### Bypass Capacitor

A capacitor is required from the noise bypass pin to ground to reduce output voltage noise. The capacitor bypasses the internal reference. A 0.01 $\mu$ F capacitor is recommended for applications that require low-noise outputs. The bypass capacitor can be increased, further reducing noise and improving PSRR. Turn-on time increases slightly with respect to bypass capacitance. A unique quick-start circuit allows the MIC5252 to drive a large capacitor on the bypass pin without significantly slowing turn-on time. Refer to the “Typical Characteristics” section for performance with different bypass capacitors.

### Active Shutdown

The MIC5252 also features an active shutdown clamp, which is an N-Channel MOSFET that turns on when the device is disabled. This allows the output capacitor and load to discharge, de-energizing the load.

### No-Load Stability

The MIC5252 will remain stable and in regulation with no load unlike many other voltage regulators. This is especially important in CMOS RAM keep-alive applications.

### Thermal Considerations

The MIC5252 is designed to provide 150mA of continuous current in a very small package. Maximum power dissipation can be calculated based on the output current and the voltage drop across the part. To determine the maximum power dissipation of the package, use the junction-to-ambient thermal resistance of the device and the following basic equation:

$$P_D(\text{max}) = \left( \frac{T_J(\text{max}) - T_A}{\theta_{JA}} \right)$$

$T_J(\text{max})$  is the maximum junction temperature of the die, 125°C, and  $T_A$  is the ambient operating temperature.  $\theta_{JA}$  is layout dependent; Table 1 shows examples of junction-to-ambient thermal resistance for the MIC5252.

| Package             | $\theta_{JA}$ Recommended Minimum Footprint | $\theta_{JA}$ 1” Square Copper Clad | $\theta_{JC}$ |
|---------------------|---|-------------------------------------|---------------|
| SOT-23-5 (M5 or D5) | 235°C/W                                     | 185°C/W                             | 145°C/W       |

Table 1. SOT-23-5 Thermal Resistance

The actual power dissipation of the regulator circuit can be determined using the equation:

$$P_D = (V_{IN} - V_{OUT}) I_{OUT} + V_{IN} I_{GND}$$

Substituting  $P_D(\text{max})$  for  $P_D$  and solving for the operating conditions that are critical to the application will give the maximum operating conditions for the regulator circuit. For example, when operating the MIC5252-2.8BM5 at 50°C with a minimum footprint layout, the maximum input voltage for a set output current can be determined as follows:

$$P_D(\text{max}) = \left( \frac{125^\circ\text{C} - 50^\circ\text{C}}{235^\circ\text{C/W}} \right)$$

$$P_D(\text{max}) = 315\text{mW}$$

The junction-to-ambient thermal resistance for the minimum footprint is 235°C/W, from Table 1. The maximum power dissipation must not be exceeded for proper operation. Using the output voltage of 2.8V and an output current of 150mA, the maximum input voltage can be determined. Because this device is CMOS and the ground current is typically 100 $\mu$ A over the load range, the power dissipation contributed by the ground current is < 1% and can be ignored for this calculation.

$$315\text{mW} = (V_{IN} - 2.8\text{V}) 150\text{mA}$$

$$315\text{mW} = V_{IN} \times 150\text{mA} - 420\text{mW}$$

$$735\text{mW} = V_{IN} \times 150\text{mA}$$

$$V_{IN}(\text{max}) = 4.9\text{V}$$

Therefore, a 2.8V application at 150mA of output current can accept a maximum input voltage of 4.9V in a SOT-23-5 package. For a full discussion of heat sinking and thermal effects on voltage regulators, refer to the “Regulator Thermals” section of Micrel’s [Designing with Low-Dropout Voltage Regulators](#) handbook.

# Package Information

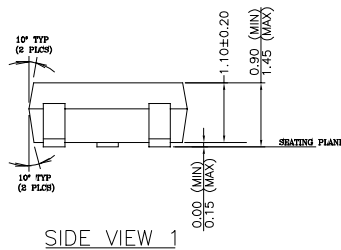
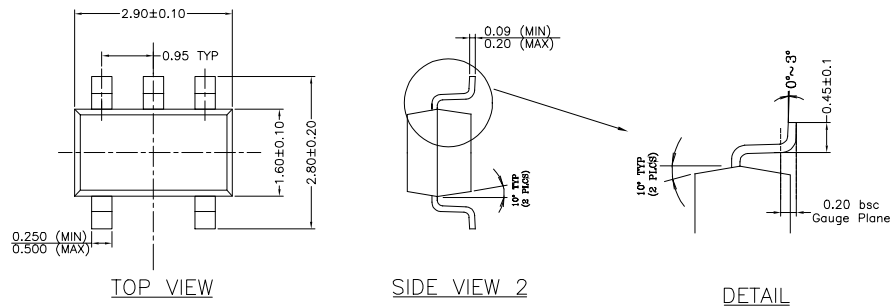

- NOTE:
1. PACKAGE OUTLINE EXCLUSIVE OF MOLD FLASH & BURR.
  2. PACKAGE OUTLINE INCLUSIVE OF SOLER PLATING.
  3. DIMENSION AND TOLERANCE PER ANSI Y14.5M, 1982.
  4. FOOT LENGTH MEASUREMENT BASED ON GAUGE PLANE METHOD.
  5. DIE FACES UP FOR MOLD, AND FACES DOWN FOR TRIM/FORM.

## SOT-23-5 (M5)

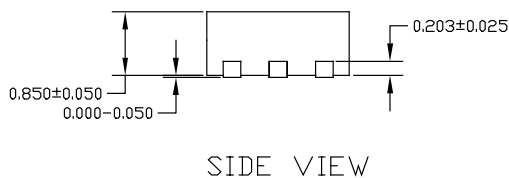
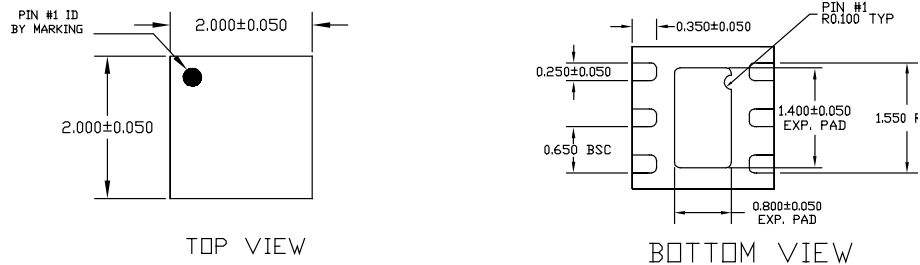

- NOTE:
1. ALL DIMENSIONS ARE IN MILLIMETERS.
  2. MAX. PACKAGE WARPAGE IS 0.05 mm.
  3. MAXIMUM ALLOWABLE BURRS IS 0.076 mm IN ALL.
  4. PIN #1 ID ON TOP WILL BE LASER MARKED.

## 6-Pin MLF™ (ML)

**MICREL INC. 2180 FORTUNE DRIVE SAN JOSE, CA 95131 USA**  
 TEL + 1 (408) 944-0800 FAX + 1 (408) 474-1000 WEB <http://www.micrel.com>

This information furnished by Micrel in this data sheet is believed to be accurate and reliable. However no responsibility is assumed by Micrel for its use. Micrel reserves the right to change circuitry and specifications at any time without notification to the customer.

Micrel Products are not designed or authorized for use as components in life support appliances, devices or systems where malfunction of a product can reasonably be expected to result in personal injury. Life support devices or systems are devices or systems that (a) are intended for surgical implant into the body or (b) support or sustain life, and whose failure to perform can be reasonably expected to result in a significant injury to the user. A Purchaser's use or sale of Micrel Products for use in life support appliances, devices or systems is a Purchaser's own risk and Purchaser agrees to fully indemnify Micrel for any damages resulting from such use or sale.

## Looking for pricing, stock, or lifecycle information?

Click below to explore more details on WIN SOURCE:

- ⊖ [View MIC5252-2.85YML-TR on WIN SOURCE](#)
- ⊖ [Microchip Technology](#) Information

## Optimize Your Supply Chain with WIN SOURCE Solutions

- ✓ Global Sourcing Solution
- ✓ Obsolete Management
- ✓ Cost Control Management
- ✓ Shortage Management
- ✓ Alternative Solution
- ✓ Excess Inventory Management