



THE DATASHEET OF MIC5264-MKYML-TR





MIC5264

150mA μ Cap Dual LDO Regulator

General Description

The MIC5264 is a dual 150mA LDO in tiny 2.5mm x 2.5mm MLF[®] packaging ideal for applications where cost is the priority. The MIC5264 is ideal for any application in portable electronics, including both RF and Digital applications. With low output noise and high PSRR, the MIC5264 is ideal for noise sensitive RF applications. While the fast transient response and active shutdown circuitry makes it well-suited for powering digital circuitry.

The MIC5264 has a 2.7V to 5.5V input operating voltage range, making it ideal for operation from a single cell lithium ion battery or fixed 3.3V and 5V systems. Each LDO is completely independent and can be powered independently, making it easier to use in distributed power applications.

The MIC5264 offers low dropout voltage (210mV at 150mA), low output noise (57 μ Vrms), high PSRR and integrates an active shutdown circuit on the output of each regulator to discharge the output voltage when disabled.

Data sheets and supporting documentation can be found on Micrel's web site at: www.micrel.com

Features

- 2.7V to 5.5V supply voltage.
- Low 75 μ A quiescent current per LDO.
- Tiny 2.5mm x 2.5mm MLF[®] package.
- Low Noise – 57 μ Vrms.
- High PSRR – 60dB at 1kHz.
- Low dropout voltage – 210mV at 150mA.
- Stable with ceramic output capacitors.
- Independent enable pins.
- Fast transient response.
- Active shutdown on both outputs.

Applications

- Cellular Telephones
- PDAs
- GPS Receivers

Typical Application

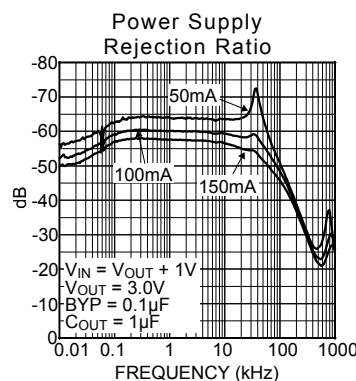
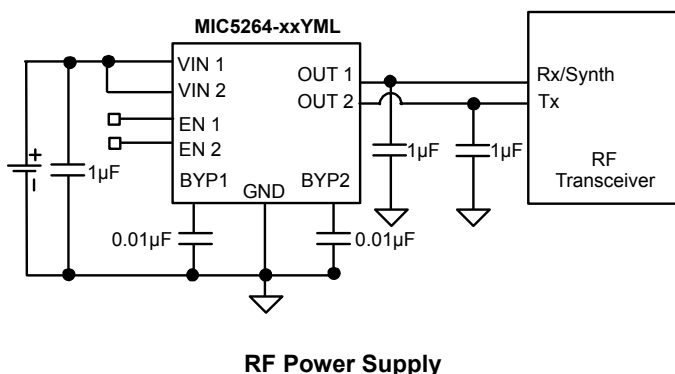

MicroLeadFrame and MLF are trademarks of Amkor Technology, Inc.

Micrel Inc. • 2180 Fortune Drive • San Jose, CA 95131 • USA • tel +1 (408) 944-0800 • fax + 1 (408) 474-1000 • <http://www.micrel.com>

May 2006

M9999-052406
(408) 955-1690

Ordering Information

Part Number		Vo1/Vo2	Marking Code	Junction Temp. Range	Package Pb-Free
Full	Manufacturing				
MIC5264-2.5/1.8YML	MIC5264-JGYML	2.5V/1.8V	MAJG	-40°C to +125°C	2.5mm x 2.5mm MLF [®]
MIC5264-2.6/1.8YML	MIC5264-KGYML	2.6V/1.8V	MAKG	-40°C to +125°C	2.5mm x 2.5mm MLF [®]
MIC5264-2.6/2.6YML	MIC5264-KKYML	2.6V/2.6V	MAKK	-40°C to +125°C	2.5mm x 2.5mm MLF [®]
MIC5264-2.8/1.5YML	MIC5264-MFYML	2.8V/1.5V	MAMF	-40°C to +125°C	2.5mm x 2.5mm MLF [®]
MIC5264-2.8/2.5YML	MIC5264-MJYML	2.8V/2.5V	MAMJ	-40°C to +125°C	2.5mm x 2.5mm MLF [®]
MIC5264-2.8/2.6YML	MIC5264-MKYML	2.8V/2.6V	MAMK	-40°C to +125°C	2.5mm x 2.5mm MLF [®]
MIC5264-2.8/2.8YML	MIC5264-MMYML	2.8V/2.8V	MAMM	-40°C to +125°C	2.5mm x 2.5mm MLF [®]
MIC5264-2.85/1.8YML	MIC5264-NGYML	2.85V/1.8V	MANG	-40°C to +125°C	2.5mm x 2.5mm MLF [®]
MIC5264-2.85/2.85YML	MIC5264-NNYML	2.85V/2.85V	MANN	-40°C to +125°C	2.5mm x 2.5mm MLF [®]
MIC5264-2.9/1.5YML	MIC5264-OFYML	2.9V/1.5V	MAOF	-40°C to +125°C	2.5mm x 2.5mm MLF [®]
MIC5264-2.9/1.8YML	MIC5264-OGYML	2.9V/1.8V	MAOG	-40°C to +125°C	2.5mm x 2.5mm MLF [®]
MIC5264-2.9/2.6YML	MIC5264-OKYML	2.9V/2.6V	MAOK	-40°C to +125°C	2.5mm x 2.5mm MLF [®]
MIC5264-3.0/1.8YML	MIC5264-PGYML	3.0V/1.8V	MAPG	-40°C to +125°C	2.5mm x 2.5mm MLF [®]
MIC5264-3.0/2.5YML	MIC5264-PJYML	3.0V/2.5V	MAPJ	-40°C to +125°C	2.5mm x 2.5mm MLF [®]
MIC5264-3.0/2.8YML	MIC5264-PMYML	3.0V/2.8V	MAPM	-40°C to +125°C	2.5mm x 2.5mm MLF [®]
MIC5264-3.0/3.0YML	MIC5264-PPYML	3.0V/3.0V	MAPP	-40°C to +125°C	2.5mm x 2.5mm MLF [®]
MIC5264-3.3/1.8YML	MIC5264-SGYML	3.3V/1.8V	MASG	-40°C to +125°C	2.5mm x 2.5mm MLF [®]
MIC5264-3.3/2.5YML	MIC5264-SJYML	3.3V/2.5V	MASJ	-40°C to +125°C	2.5mm x 2.5mm MLF [®]
MIC5264-3.3/3.0YML	MIC5264-SPYML	3.3V/3.0V	MASP	-40°C to +125°C	2.5mm x 2.5mm MLF [®]
MIC5264-3.3/3.3YML	MIC5264-SSYML	3.3V/3.3V	MASS	-40°C to +125°C	2.5mm x 2.5mm MLF [®]

Note:

1. Other Voltage Combinations available. Contact Micrel for details.

Pin Configuration

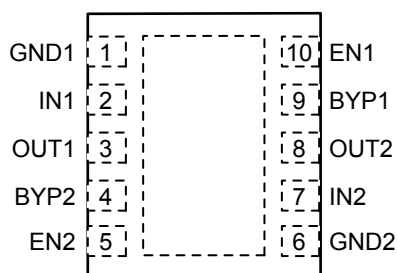

2.5mm x 2.5mm MLF-10L (ML)

Pin Description

Pin Number	Pin Name	Pin Function
1	GND1	Ground
2	IN1	Supply Voltage
3	OUT1	Regulator Output
4	BYP2	Reference Bypass: Connect external 0.01 μ F \leq C _{BYP} \leq 1.0 μ F capacitor to GND to reduce output noise. Do not leave open.
5	EN2	Enable/Shutdown (Input): CMOS compatible input. Logic high = enable; logic low = shutdown. Do not leave open.
6	GND2	Ground
7	IN2	Supply Voltage
8	OUT2	Regulator Output
9	BYP1	Reference Bypass: Connect external 0.01 μ F \leq C _{BYP} \leq 1.0 μ F capacitor to GND to reduce output noise. Do not leave open.
10	EN1	Enable/Shutdown (Input): CMOS compatible input. Logic high = enable; logic low = shutdown. Do not leave open.
EP	Exposed Pad	Exposed Pad. Connect to external ground pins.

Absolute Maximum Ratings⁽¹⁾

Supply Input Voltage ($V_{IN1/IN2}$)	0V to +7V
Enable Input Voltage ($V_{EN1/EN2}$)	0V to +7V
Power Dissipation (P_D)	Internally Limited ⁽³⁾
Junction Temperature (T_J)	-40°C to 125°C
Lead Temperature (soldering, #sec.)	-55°C to 150°C
Storage Temperature (T_S)	260°C
EDS Rating ⁽⁴⁾	2kV

Operating Ratings⁽²⁾

Supply Input Voltage ($V_{IN1/IN2}$)	+2.7V to +5.5V
Enable Input Voltage ($V_{EN1/EN2}$)	0V to + V_{IN}
Junction Temperature (T_A)	-40°C to +125°C
Junction Thermal Resistance	
MLF-10L (θ_{JA})	75°C/W

Electrical Characteristics⁽⁵⁾

$V_{EN} = V_{IN} = V_{OUT} + 1V$; $I_L = 100\mu A$; $C_L = 1.0\mu F$; $C_{BYP} = 0.01\mu F$ per output; $T_A = 25^\circ C$, **bold** values indicate $-40^\circ C \leq T_A \leq +85^\circ C$; unless noted.

Parameter	Condition	Min	Typ	Max	Units
Output Voltage Accuracy	$I_{OUT} = 100\mu A$	-2 -3		2 3	% %
Line Regulation	$V_{IN} = V_{OUT} + 1V$ to 5.5V		0.05	0.2	%
Load Regulation	$I_{OUT} = 0.1mA$ to 150mA		2	3	%
Dropout Voltage	$I_{OUT} = 50mA$ $I_{OUT} = 150mA$		75 210	500	mV mV
Quiescent Current	$V_{EN} < 0.4V$		0.2	2	μA
Ground Pin Current (Per Regulator)	$I_{OUT} = 0mA$ $I_{OUT} = 150mA$		75 80	120 150	μA μA
PSRR (Ripple Rejection)	$f = 100Hz$, $C_{BYP} = 0.1\mu F$, $I_{LOAD} = 50mA$ $f = 1kHz$, $C_{BYP} = 0.1\mu F$, $I_{LOAD} = 50mA$ $f = 10kHz$, $C_{BYP} = 0.1\mu F$, $I_{LOAD} = 50mA$		62 64 64		dB dB dB
Current Limit	$V_{OUT} = 0V$		225		mA
Output Noise	$C_{OUT} = 1.0\mu F$, $C_{BYP} = 0.1\mu F$, $f = 10Hz$ to 100kHz		57		μV (rms)
Enable Input (EN1 and EN2)					
Enable Input Logic Low	$V_{IN} = 2.7V$ to 5.5V, regulator shutdown			0.2	V
Enable Input Logic High	$V_{IN} = 2.7V$ to 5.5V, regulator enabled	1.6			V
Enable Input Current	$V_{IL} < 0.4V$, regulator shutdown $V_{IH} > 1.6V$, regulator enabled		0.01 0.01		μA μA
Thermal Shutdown					
Thermal Shutdown Temperature			150		$^\circ C$
Hysteresis			10		$^\circ C$
Turn-on/Turn-off Characteristics					
Turn-on Time			40	150	μs
Discharge Resistance			500		Ω

Notes:

- Exceeding the absolute maximum rating may damage the device.
- The device is not guaranteed to function outside its operating rating.
- The maximum allowable power dissipation of any T_A (ambient temperature) is $P_{D(max)} = (T_{J(max)} - T_A) / \theta_{JA}$. Exceeding the maximum allowable power dissipation will result in excessive die temperature, and the regulator will go into thermal shutdown. The θ_{JA} of the MIC5264x.xYML (all versions) is 75°C/W on a PC board (see "Thermal Considerations" section for further details).
- Devices are ESD sensitive. Handling precautions recommended. Human body model, 1.5k in series with 100pF.
- Specification for packaged product only.

Typical Characteristics

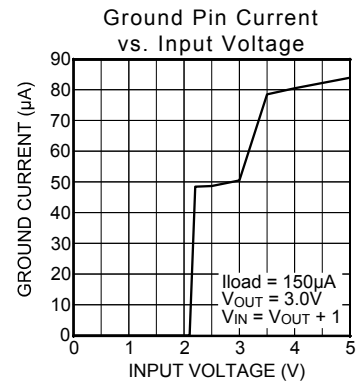
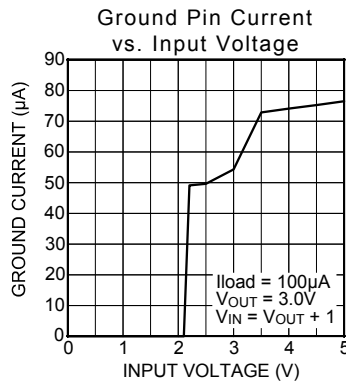
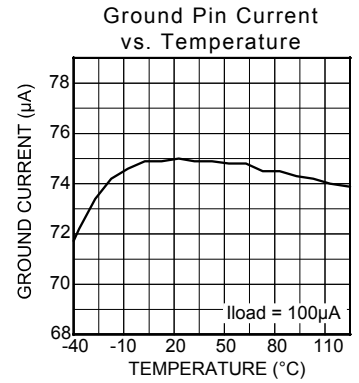
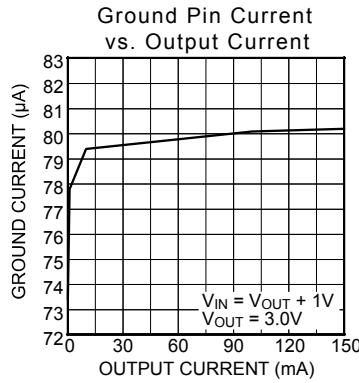
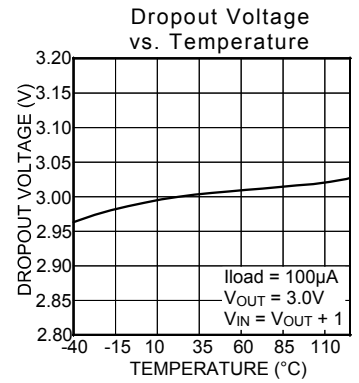
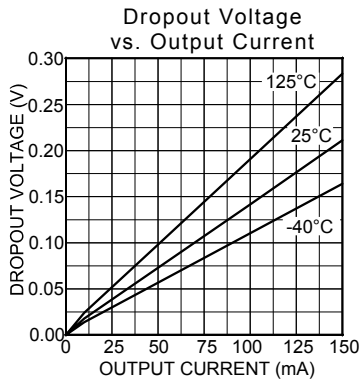

Typical Characteristics (continued)

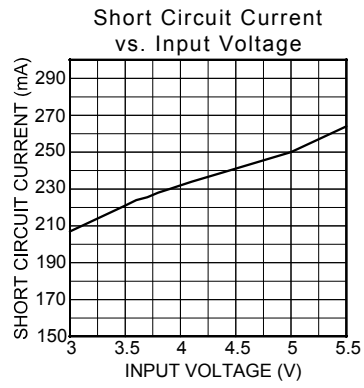

Functional Characteristics

Line Transient Response

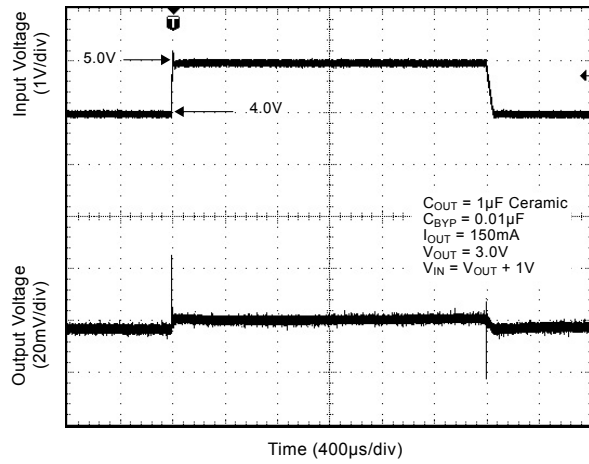

Load Transient Response

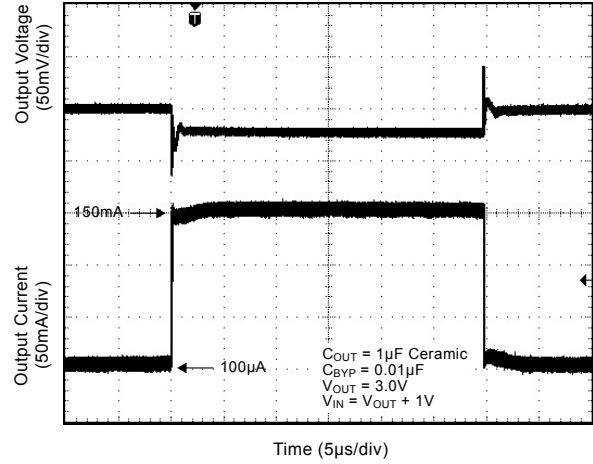

Enable Pin Delay

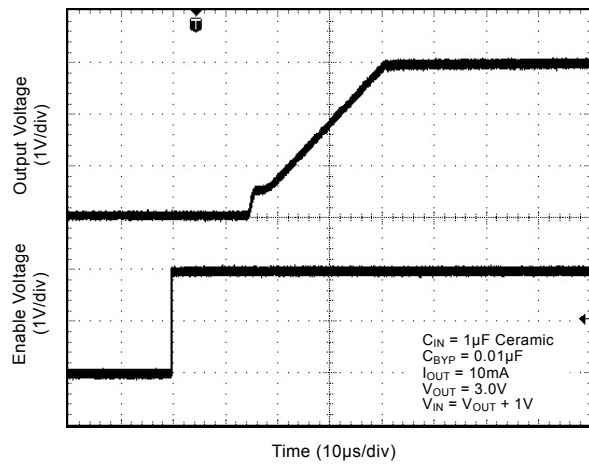

Shutdown Delay

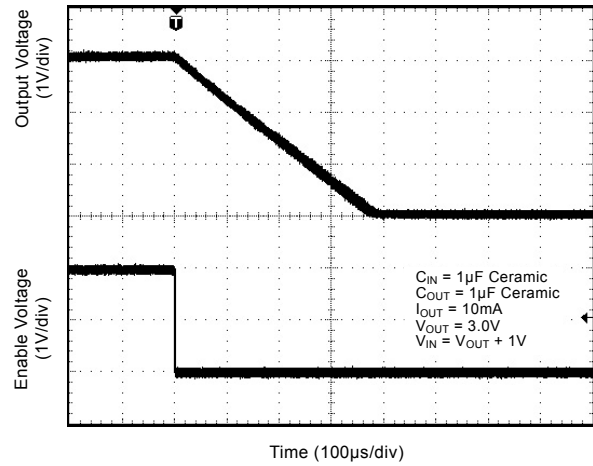

Block Diagram

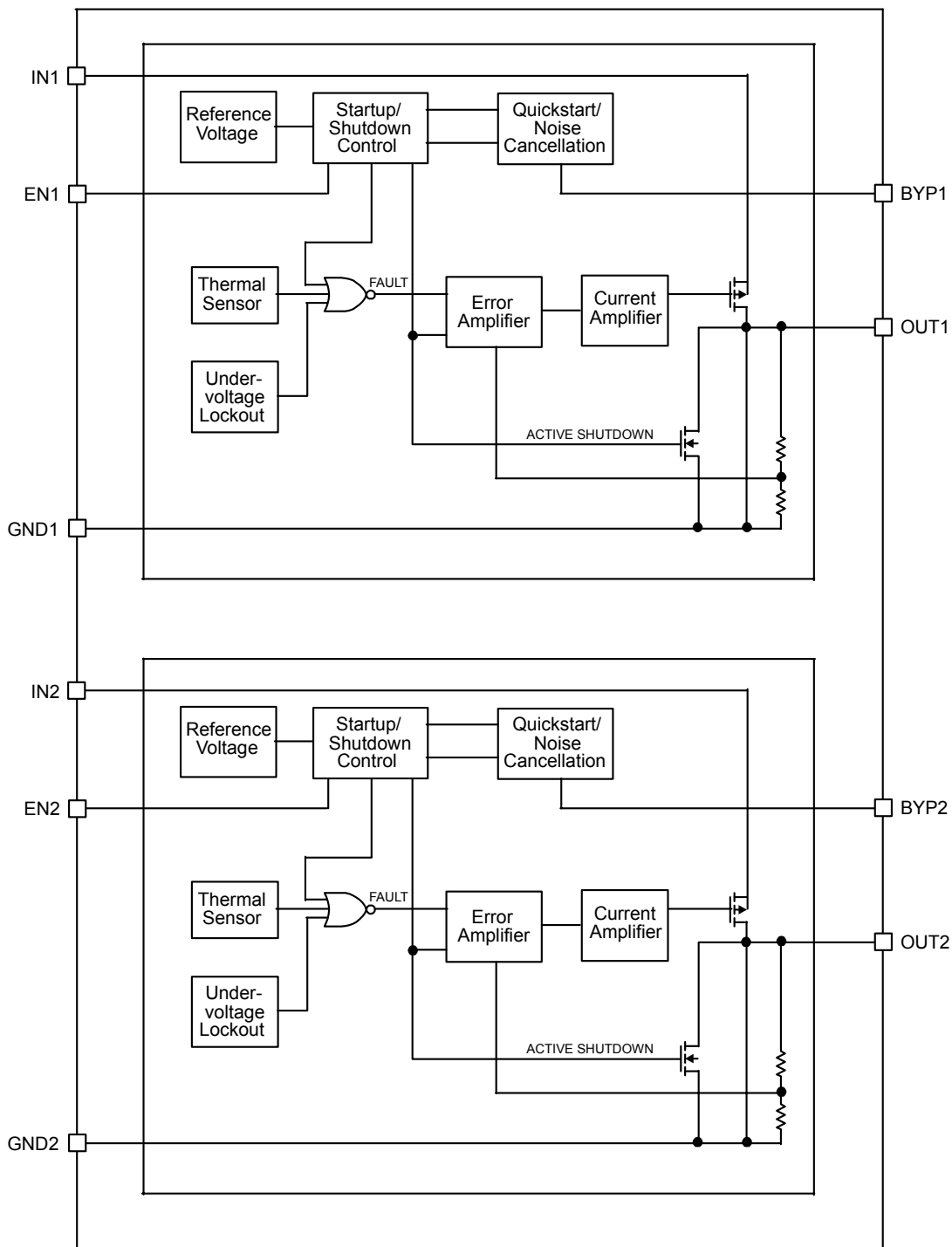

MIC5264 Diagram

Application Information

Enable/Shutdown

The MIC5264 comes with two independent active-high enable pins that allow the regulator in each output to be disabled separately. Forcing the enable pin low disables the regulator and sends it into a “zero” off-mode current state. In this state, current consumed by the regulator goes nearly to zero. Forcing the enable pin high enables the output voltage. This part is CMOS and the enable pin cannot be left floating; a floating enable pin may cause an indeterminate state on the output.

Input Capacitor

The MIC5264 is a high performance, high bandwidth device. Therefore, it requires well-bypassed input supplies for optimal performance. A 1uF capacitor is required from the input to ground to provide stability. Low-ESR ceramic capacitors provide optimal performance at a minimum of space. Additional high-frequency capacitors, such as small valued NPO dielectric type capacitors, help filter out high-frequency noise and are good practice in any RF-based circuit.

Output Capacitor

The MIC5264 requires capacitors at both outputs for stability. The design requires 1uF or greater on each output to maintain stability. The design is optimized for use with low-ESR ceramic chip capacitors. High ESR capacitors may cause high frequency oscillation. The maximum recommended ESR is 300mΩ. The output capacitor can be increased, but performance has been optimized for a 1uF ceramic output capacitor and does not improve significantly with larger capacitance.

X7R/X5R dielectric-type ceramic capacitors are recommended because of their temperature performance. X7R type capacitors change capacitance by 15% over their operating temperature range and are the most stable type of ceramic capacitors. Z5U and Y5V dielectric capacitors change value by as much as 50% and 60%, respectively, over their operating temperature ranges. To use a ceramic chip capacitor with Y5V dielectric, the value must be much higher than an X7R ceramic capacitor to ensure the same minimum capacitance over the equivalent operating temperature range.

Bypass Capacitor

A capacitor can be placed from the noise bypass pin to ground to reduce output voltage noise. The capacitor bypasses the internal reference. A 0.01uF capacitor is recommended for applications that require low-noise outputs. The bypass capacitor can be increased, further reducing noise and improving PSRR. Turn-on time

increases slightly with respect to bypass capacitance. A unique quick-start circuit allows the MIC5264 to drive a large capacitor on the bypass pin without significantly slowing turn-on time.

Active Shutdown

The MIC5264 also features an active shutdown clamp, which is an N-channel MOSFET that turns on when the device is disabled. This allows the output capacitor and load to discharge, de-energizing the load.

No-Load Stability

The MIC5264 will remain stable and in regulation with no load unlike many other voltage regulators. This is especially important in CMOS RAM keep-alive applications.

Thermal Considerations

The MIC5264 is designed to provide 150mA of continuous current per output in a very small package. Maximum ambient operating temperature can be calculated based on the output current and the voltage drop across the part. Given that the input voltage is 5.0V, the V_{OUT1} output voltage is 3.0V at 150mA; V_{OUT2} output voltage is 2.8V at 100mA.

The actual power dissipation of the regulator circuit can be determined using the equation:

$$P_D = (V_{IN} - V_{OUT}) I_{OUT} + V_{IN} I_{GND}$$

Because this device is CMOS and the ground current is typically <100uA over the load range, the power dissipation contributed by the ground current is < 1% and can be ignored for this calculation.

$$P_D = (5.0V - 3.0V) \times 150mA + (5.0V - 2.8V) \times 100mA$$

$$P_D = 0.52W$$

To determine the maximum ambient operating temperature of the package, use the junction-to-ambient thermal resistance of the device and the following basic equation:

$$P_{D(max)} = \left(\frac{T_{J(max)} - T_A}{\theta_{JA}} \right)$$

$T_{J(max)} = 125^\circ\text{C}$, the max. junction temperature of the die
 θ_{JA} thermal resistance = 63°C/W

MIC5264 Junction-To-Ambient Thermal Resistance

Package	θ_{JA} Recommended Minimum Footprint	θ_{JC}
2.5mm x 2.5mm MLF-10	75°C/W	2°C/W

Thermal Resistance

Substituting P_D for $P_{D(max)}$ and solving for the ambient operating temperature will give the maximum operating conditions for the regulator circuit. The junction-to-ambient thermal resistance for the minimum footprint is 63°C/W. The maximum power dissipation must not be exceeded for proper operation.

For example, when operating the MIC5264PMYML at an input voltage of 5.0V at 150mA on V_{OUT1} and 100mA on V_{OUT2} with a minimum footprint layout, the maximum ambient operating temperature T_A can be determined as follows:

$$0.52W = \left(\frac{125^\circ C - T_A}{63^\circ C} \right)$$

$$T_A = 92.24^\circ C$$

Therefore, a 3.0V application at 150mA on Ch1 and 2.8V at 100mA on Ch2 can accept an ambient operating temperature of 92°C in a 10-pin 2.5mm x 2.5mm MLF[®] package. For a full discussion of heat sinking and thermal effects on voltage regulators, refer to the "Regulator Thermals" section of *Micrel's Designing with Low-Dropout Voltage Regulators* handbook. This information can be found on Micrel's website at:

http://www.micrel.com/_PDF/other/LDOBk_ds.pdf

Package Information

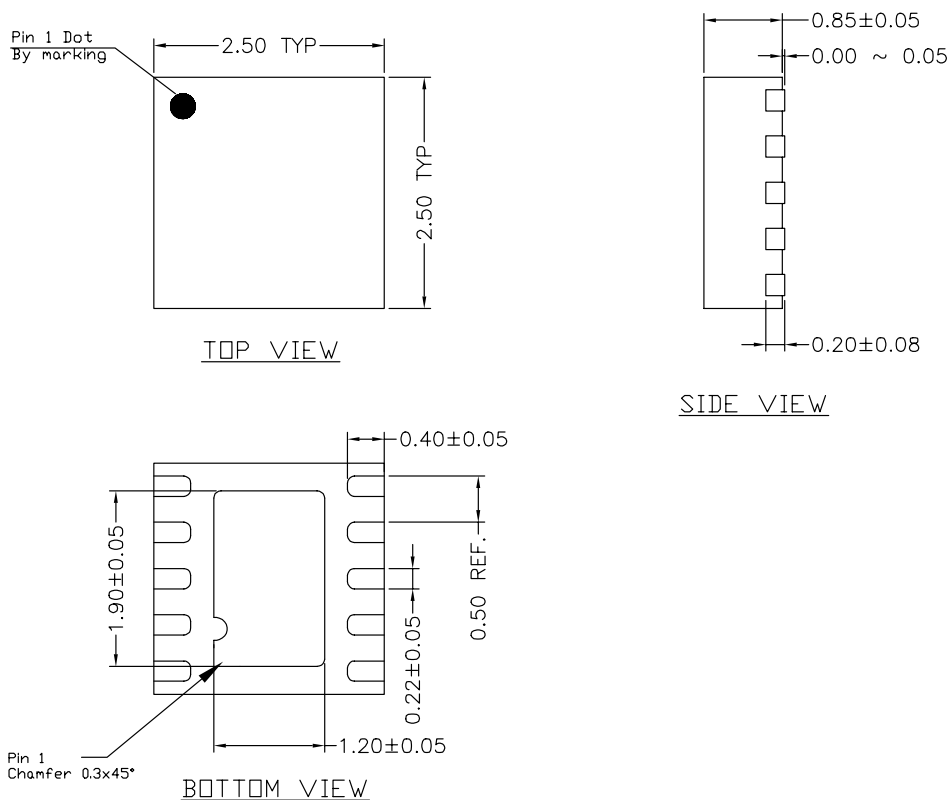

10-Pin MLF (ML)

MICREL, INC. 2180 FORTUNE DRIVE SAN JOSE, CA 95131 USA
 TEL +1 (408) 944-0800 FAX +1 (408) 474-1000 WEB <http://www.micrel.com>

The information furnished by Micrel in this data sheet is believed to be accurate and reliable. However, no responsibility is assumed by Micrel for its use. Micrel reserves the right to change circuitry and specifications at any time without notification to the customer.

Micrel Products are not designed or authorized for use as components in life support appliances, devices or systems where malfunction of a product can reasonably be expected to result in personal injury. Life support devices or systems are devices or systems that (a) are intended for surgical implant into the body or (b) support or sustain life, and whose failure to perform can be reasonably expected to result in a significant injury to the user. A Purchaser's use or sale of Micrel Products for use in life support appliances, devices or systems is a Purchaser's own risk and Purchaser agrees to fully indemnify Micrel for any damages resulting from such use or sale.

© 2005 Micrel, Incorporated.

Looking for pricing, stock, or lifecycle information?

Click below to explore more details on WIN SOURCE:

- ⊖ [View MIC5264-MKYML-TR on WIN SOURCE](#)
- ⊖ [Microchip Technology](#) Information

Optimize Your Supply Chain with WIN SOURCE Solutions

- ✓ Global Sourcing Solution
- ✓ Obsolete Management
- ✓ Cost Control Management
- ✓ Shortage Management
- ✓ Alternative Solution
- ✓ Excess Inventory Management