



MIC5320

High-Performance Dual 150mA
 μ Cap ULDO™

General Description

The MIC5320 is a tiny Dual Ultra Low-Dropout (ULDO™) linear regulator ideally suited for portable electronics. It's ideal for today's most demanding ultra-thin portable applications including mobile phones, camera modules, imaging sensors for digital still and video cameras, PDAs, portable media players (PMP) and PC cameras. The MIC5320 integrates two high-performance, 150mA ULDOs into a tiny 6-pin 1.6mm x 1.6mm leadless Thin MLF® package, which provides exceptional thermal package characteristics.

The MIC5320 is a μ Cap design which enables operation with very small ceramic output capacitors for stability, thereby reducing required board space and component cost. The combination of extremely low-dropout voltage, fast transient response and exceptional thermal package characteristics makes it ideal for portable electronics.

The MIC5320 ULDO™ is available in fixed-output voltages in the tiny 6-pin 1.6mm x 1.6mm leadless Thin MLF® package which is only 2.56mm² in area, less than 30% the area of the SOT-23, TSOP and MLF® 3x3 packages. It's also available in the thin SOT-23-6 lead package and the standard 6-pin 1.6mm x 1.6mm leadless package. Additional voltage options are available. For more information, contact Micrel marketing department.

Data sheets and supporting documentation can be found on Micrel's web site at: www.micrel.com.

Features

- 2.3V to 5.5V input voltage range
- Ultra-low dropout voltage ULDO™ 35mV @ 150mA
- Tiny 6-pin 1.6mm x 1.6mm Thin MLF® leadless package
- Low-cost TSOT-23-6 package
- Independent enable pins
- 150mA output current per LDO
- μ Cap stable with 1 μ F ceramic capacitor
- Low quiescent current – 85 μ A per output
- Fast turn-on time – 30 μ s
- Thermal-shutdown protection
- Current-limit protection

Applications

- Mobile phones
- PDAs
- GPS receivers
- Portable electronics
- Portable media players
- Digital still and video cameras

Typical Application

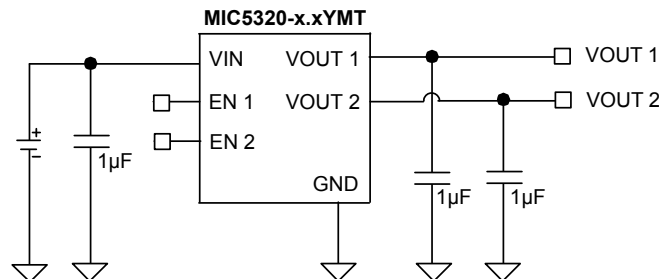

Typical Application Circuit

ULDO is a trademark of Micrel, Inc.

MLF and *MicroLeadFrame* are registered trademarks of Amkor Technologies, Inc.

Micrel Inc. • 2180 Fortune Drive • San Jose, CA 95131 • USA • tel +1 (408) 944-0800 • fax + 1 (408) 474-1000 • <http://www.micrel.com>

Ordering Information

Part Number	Manufacturing Part Number	Marking*	V _{OUT1} /V _{OUT2} **	Junction Temp. Range	Package
MIC5320-1.8/1.5YMT	MIC5320-GFYMT	AGF	1.8V/1.5V	-40°C to +125°C	6-Pin 1.6x1.6 Thin MLF [®]
MIC5320-1.8/1.6YMT	MIC5320-GWYMT	AGW	1.8V/1.6V	-40°C to +125°C	6-Pin 1.6x1.6 Thin MLF [®]
MIC5320-1.8/1.8YMT	MIC5320-GGYMT	AGG	1.8V/1.8V	-40°C to +125°C	6-Pin 1.6x1.6 Thin MLF [®]
MIC5320-2.4/1.5YMT	MIC5320-H4FYMT	H4F	2.4V/1.5V	-40°C to +125°C	6-Pin 1.6x1.6 Thin MLF [®]
MIC5320-2.5/1.8YMT	MIC5320-JGYMT	AJG	2.5V/1.8V	-40°C to +125°C	6-Pin 1.6x1.6 Thin MLF [®]
MIC5320-2.5/2.5YMT	MIC5320-JJYMT	AJJ	2.5V/2.5V	-40°C to +125°C	6-Pin 1.6x1.6 Thin MLF [®]
MIC5320-2.6/1.85YMT	MIC5320-KDYMT	AKD	2.6V/1.85	-40°C to +125°C	6-Pin 1.6x1.6 Thin MLF [®]
MIC5320-2.6/1.8YMT	MIC5320-KGYMT	AKG	2.6V/1.8V	-40°C to +125°C	6-Pin 1.6x1.6 Thin MLF [®]
MIC5320-2.7/2.7YMT	MIC5320-LLYMT	ALL	2.7V/2.7V	-40°C to +125°C	6-Pin 1.6x1.6 Thin MLF [®]
MIC5320-2.8/1.5YMT	MIC5320-MFYMT	AMF	2.8V/1.5V	-40°C to +125°C	6-Pin 1.6x1.6 Thin MLF [®]
MIC5320-2.8/1.8YMT	MIC5320-MGYMT	AMG	2.8V/1.8V	-40°C to +125°C	6-Pin 1.6x1.6 Thin MLF [®]
MIC5320-2.8/2.6YMT	MIC5320-MKYMT	AMK	2.8V/2.6V	-40°C to +125°C	6-Pin 1.6x1.6 Thin MLF [®]
MIC5320-2.8/2.8YMT	MIC5320-MMYMT	AMM	2.8V/2.8V	-40°C to +125°C	6-Pin 1.6x1.6 Thin MLF [®]
MIC5320-2.85/1.85YMT	MIC5320-NDYMT	AND	2.85V/1.85V	-40°C to +125°C	6-Pin 1.6x1.6 Thin MLF [®]
MIC5320-2.85/2.6YMT	MIC5320-NKYMT	ANK	2.85V/2.6V	-40°C to +125°C	6-Pin 1.6x1.6 Thin MLF [®]
MIC5320-2.85/2.85YMT	MIC5320-NNYMT	ANN	2.85V/2.85V	-40°C to +125°C	6-Pin 1.6x1.6 Thin MLF [®]
MIC5320-2.9/1.5YMT	MIC5320-OFYMT	AOF	2.9V/1.5V	-40°C to +125°C	6-Pin 1.6x1.6 Thin MLF [®]
MIC5320-2.9/1.8YMT	MIC5320-OGYMT	AOG	2.9V/1.8V	-40°C to +125°C	6-Pin 1.6x1.6 Thin MLF [®]
MIC5320-2.9/2.9YMT	MIC5320-OOYMT	AOO	2.9V/2.9V	-40°C to +125°C	6-Pin 1.6x1.6 Thin MLF [®]
MIC5320-3.0/1.8YMT	MIC5320-PGYMT	APG	3.0V/1.8V	-40°C to +125°C	6-Pin 1.6x1.6 Thin MLF [®]
MIC5320-3.0/2.5YMT	MIC5320-PJYMT	APJ	3.0V/2.5V	-40°C to +125°C	6-Pin 1.6x1.6 Thin MLF [®]
MIC5320-3.0/2.6YMT	MIC5320-PKYMT	APK	3.0V/2.6V	-40°C to +125°C	6-Pin 1.6x1.6 Thin MLF [®]
MIC5320-3.0/2.8YMT	MIC5320-PMYMT	APM	3.0V/2.8V	-40°C to +125°C	6-Pin 1.6x1.6 Thin MLF [®]
MIC5320-3.0/2.85YMT	MIC5320-PNYMT	APN	3.0V/2.85V	-40°C to +125°C	6-Pin 1.6x1.6 Thin MLF [®]
MIC5320-3.0/3.0YMT	MIC5320-PPYMT	APP	3.0V/3.0V	-40°C to +125°C	6-Pin 1.6x1.6 Thin MLF [®]
MIC5320-3.3/1.5YMT	MIC5320-SFYMT	ASF	3.3V/1.5V	-40°C to +125°C	6-Pin 1.6x1.6 Thin MLF [®]
MIC5320-3.3/1.8YMT	MIC5320-SGYMT	ASG	3.3V/1.8V	-40°C to +125°C	6-Pin 1.6x1.6 Thin MLF [®]
MIC5320-3.3/2.5YMT	MIC5320-SJYMT	ASJ	3.3V/2.5V	-40°C to +125°C	6-Pin 1.6x1.6 Thin MLF [®]
MIC5320-3.3/2.6YMT	MIC5320-SKYMT	ASK	3.3V/2.6V	-40°C to +125°C	6-Pin 1.6x1.6 Thin MLF [®]
MIC5320-3.3/2.7YMT	MIC5320-SLYMT***	ASL	3.3V/2.7V	-40°C to +125°C	6-Pin 1.6x1.6 Thin MLF [®]
MIC5320-3.3/2.8YMT	MIC5320-SMYMT	ASM	3.3V/2.8V	-40°C to +125°C	6-Pin 1.6x1.6 Thin MLF [®]
MIC5320-3.3/2.85YMT	MIC5320-SNYMT	ASN	3.3V/2.85V	-40°C to +125°C	6-Pin 1.6x1.6 Thin MLF [®]
MIC5320-3.3/2.9YMT	MIC5320-SOYMT	ASO	3.3V/2.9V	-40°C to +125°C	6-Pin 1.6x1.6 Thin MLF [®]
MIC5320-3.3/3.0YMT	MIC5320-SPYMT	ASP	3.3V/3.0V	-40°C to +125°C	6-Pin 1.6x1.6 Thin MLF [®]
MIC5320-3.3/3.2YMT	MIC5320-SRYMT	ASR	3.3V/3.2V	-40°C to +125°C	6-Pin 1.6x1.6 Thin MLF [®]
MIC5320-3.3/3.3YMT	MIC5320-SSYMT	ASS	3.3V/3.3V	-40°C to +125°C	6-Pin 1.6x1.6 Thin MLF [®]
MIC5320-4.6/2.8YMT	MIC5320-46MYMT	46M	4.6V/2.8V	-40°C to +125°C	6-Pin 1.6x1.6 Thin MLF [®]
MIC5320-2.5/1.8YML	MIC5320-JGYML	$\overline{\text{AJG}}$	2.5V/1.8V	-40°C to +125°C	6-Pin 1.6x1.6 MLF [®]
MIC5320-2.5/2.5YML	MIC5320-JJYML***	$\overline{\text{AJJ}}$	2.5V/2.5V	-40°C to +125°C	6-Pin 1.6x1.6 MLF [®]
MIC5320-2.6/1.8YML	MIC5320-KGYML	$\overline{\text{AKG}}$	2.6V/1.8V	-40°C to +125°C	6-Pin 1.6x1.6 MLF [®]
MIC5320-2.7/2.7YML	MIC5320-LLYML	$\overline{\text{ALL}}$	2.7V/2.7V	-40°C to +125°C	6-Pin 1.6x1.6 MLF [®]
MIC5320-2.8/1.5YML	MIC5320-MFYML	$\overline{\text{AMF}}$	2.8V/1.5V	-40°C to +125°C	6-Pin 1.6x1.6 MLF [®]
MIC5320-2.8/1.8YML	MIC5320-MGYML	$\overline{\text{AMG}}$	2.8V/1.8V	-40°C to +125°C	6-Pin 1.6x1.6 MLF [®]
MIC5320-2.8/2.8YML	MIC5320-MMYML	$\overline{\text{AMM}}$	2.8V/2.8V	-40°C to +125°C	6-Pin 1.6x1.6 MLF [®]
MIC5320-3.0/2.5YML	MIC5320-PJYML	$\overline{\text{APJ}}$	3.0V/2.5V	-40°C to +125°C	6-Pin 1.6x1.6 MLF [®]
MIC5320-3.0/2.6YML	MIC5320-PKYML	$\overline{\text{APK}}$	3.0V/2.6V	-40°C to +125°C	6-Pin 1.6x1.6 MLF [®]

Part Number	Manufacturing Part Number	Marking*	V _{OUT1} /V _{OUT2} **	Junction Temp. Range	Package
MIC5320-3.0/3.0YML	MIC5320-PPYML	<u>APP</u>	3.0V/3.0V	-40°C to +125°C	6-Pin 1.6x1.6 MLF®
MIC5320-3.3/1.8YML	MIC5320-SGYML	<u>ASG</u>	3.3V/1.8V	-40°C to +125°C	6-Pin 1.6x1.6 MLF®
MIC5320-3.3/2.5YML	MIC5320-SJYML	<u>ASJ</u>	3.3V/2.5V	-40°C to +125°C	6-Pin 1.6x1.6 MLF®
MIC5320-3.3/2.7YML	MIC5320-SLYML***	<u>ASL</u>	3.3V/2.7V	-40°C to +125°C	6-Pin 1.6x1.6 MLF®
MIC5320-3.3/2.8YML	MIC5320-SMYML	<u>ASM</u>	3.3V/2.8V	-40°C to +125°C	6-Pin 1.6x1.6 MLF®
MIC5320-1.8/1.5YD6	MIC5320-GFYD6	<u>QAGF</u>	1.8V/1.5V	-40°C to +125°C	6-Pin TSOT-23
MIC5320-1.8/1.8YD6	MIC5320-GGYD6	<u>QAGG</u>	1.8V/1.8V	-40°C to +125°C	6-Pin TSOT-23
MIC5320-1.8/1.6YD6	MIC5320-GWYD6***	<u>QAGW</u>	1.8V/1.6V	-40°C to +125°C	6-Pin TSOT-23
MIC5320-2.4/1.5YD6	MIC5320-H4FYD6	<u>QH4F</u>	2.4V/1.5V	-40°C to +125°C	6-Pin TSOT-23
MIC5320-2.5/1.8YD6	MIC5320-JGYD6	<u>QAJG</u>	2.5V/1.8V	-40°C to +125°C	6-Pin TSOT-23
MIC5320-2.5/2.5YD6	MIC5320-JJYD6***	<u>QAJJ</u>	2.5V/2.5V	-40°C to +125°C	6-Pin TSOT-23
MIC5320-2.6/1.85YD6	MIC5320-KDYD6***	<u>QAKD</u>	2.6V/1.85V	-40°C to +125°C	6-Pin TSOT-23
MIC5320-2.6/1.8YD6	MIC5320-KGYD6	<u>QAKG</u>	2.6V/1.8V	-40°C to +125°C	6-Pin TSOT-23
MIC5320-2.7/2.7YD6	MIC5320-LLYD6	<u>QALL</u>	2.7V/2.7V	-40°C to +125°C	6-Pin TSOT-23
MIC5320-2.8/1.5YD6	MIC5320-MFYD6	<u>QAMF</u>	2.8V/1.5V	-40°C to +125°C	6-Pin TSOT-23
MIC5320-2.8/1.8YD6	MIC5320-MGYD6	<u>QAMG</u>	2.8V/1.8V	-40°C to +125°C	6-Pin TSOT-23
MIC5320-2.8/2.6YD6	MIC5320-MKYD6	<u>QAMK</u>	2.8V/2.6V	-40°C to +125°C	6-Pin TSOT-23
MIC5320-2.8/2.8YD6	MIC5320-MMYD6	<u>QAMM</u>	2.8V/2.8V	-40°C to +125°C	6-Pin TSOT-23
MIC5320-2.85/1.85YD6	MIC5320-NDYD6***	<u>QAND</u>	2.85V/1.85V	-40°C to +125°C	6-Pin TSOT-23
MIC5320-2.85/2.6YD6	MIC5320-NKYD6***	<u>QANK</u>	2.85V/2.6V	-40°C to +125°C	6-Pin TSOT-23
MIC5320-2.85/2.85YD6	MIC5320-NNYD6	<u>QANN</u>	2.85V/2.85V	-40°C to +125°C	6-Pin TSOT-23
MIC5320-2.9/1.5YD6	MIC5320-OFYD6***	<u>QAOF</u>	2.9V/1.5V	-40°C to +125°C	6-Pin TSOT-23
MIC5320-2.9/1.8YD6	MIC5320-OGYD6***	<u>QAOG</u>	2.9V/1.8V	-40°C to +125°C	6-Pin TSOT-23
MIC5320-2.9/2.9YD6	MIC5320-OOYD6***	<u>QAoo</u>	2.9V/2.9V	-40°C to +125°C	6-Pin TSOT-23
MIC5320-3.0/1.8YD6	MIC5320-PGYD6	<u>QAPG</u>	3.0V/1.8V	-40°C to +125°C	6-Pin TSOT-23
MIC5320-3.0/2.5YD6	MIC5320-PJYD6***	<u>QAPJ</u>	3.0V/2.5V	-40°C to +125°C	6-Pin TSOT-23
MIC5320-3.0/2.6YD6	MIC5320-PKYD6	<u>QAPK</u>	3.0V/2.6V	-40°C to +125°C	6-Pin TSOT-23
MIC5320-3.0/2.8YD6	MIC5320-PMYD6***	<u>QAPM</u>	3.0V/2.8V	-40°C to +125°C	6-Pin TSOT-23
MIC5320-3.0/2.85YD6	MIC5320-PNYD6***	<u>QAPN</u>	3.0V/2.85V	-40°C to +125°C	6-Pin TSOT-23
MIC5320-3.0/3.0YD6	MIC5320-PPYD6	<u>QAPP</u>	3.0V/3.0V	-40°C to +125°C	6-Pin TSOT-23
MIC5320-3.3/1.5YD6	MIC5320-SFYD6	<u>QASF</u>	3.3V/1.5V	-40°C to +125°C	6-Pin TSOT-23
MIC5320-3.3/1.8YD6	MIC5320-SGYD6	<u>QASG</u>	3.3V/1.8V	-40°C to +125°C	6-Pin TSOT-23
MIC5320-3.3/2.5YD6	MIC5320-SJYD6	<u>QASJ</u>	3.3V/2.5V	-40°C to +125°C	6-Pin TSOT-23
MIC5320-3.3/2.6YD6	MIC5320-SKYD6***	<u>QASK</u>	3.3V/2.6V	-40°C to +125°C	6-Pin TSOT-23
MIC5320-3.3/2.7YD6	MIC5320-SLYD6***	<u>QASL</u>	3.3V/2.7V	-40°C to +125°C	6-Pin TSOT-23
MIC5320-3.3/2.8YD6	MIC5320-SMYD6***	<u>QASM</u>	3.3V/2.8V	-40°C to +125°C	6-Pin TSOT-23
MIC5320-3.3/2.85YD6	MIC5320-SNYD6***	<u>QASN</u>	3.3V/2.85V	-40°C to +125°C	6-Pin TSOT-23
MIC5320-3.3/2.9YD6	MIC5320-SOYD6***	<u>QASO</u>	3.3V/2.9V	-40°C to +125°C	6-Pin TSOT-23
MIC5320-3.3/3.0YD6	MIC5320-SPYD6	<u>QASP</u>	3.3V/3.0V	-40°C to +125°C	6-Pin TSOT-23
MIC5320-3.3/3.2YD6	MIC5320-SRYD6***	<u>QASR</u>	3.3V/3.2V	-40°C to +125°C	6-Pin TSOT-23
MIC5320-3.3/3.3YD6	MIC5320-SSYD6	<u>QASS</u>	3.3V/3.3V	-40°C to +125°C	6-Pin TSOT-23

Notes

MLF® is a GREEN RoHS-compliant package. Lead finish is NiPdAu. Mold compound is Halogen Free.

* Under bar ()/Over bar () symbol may not be to scale. Thin MLF (MT) package Pin 1 identified = ▲.

** For other voltages available. Contact Micrel for more details.

*** Contact Micrel Marketing for availability.

Pin Configuration



**6-Pin 1.6mm x 1.6mm Thin MLF (MT) / MLF (ML)
Top View**



**TSOT-23-6 (D6)
Top View**

Pin Description

Pin Number Thin MLF-6 / MLF-6	Pin Number TSOT-23-6	Pin Name	Pin Function
1	3	VIN	Supply Input.
2	2	GND	Ground
3	1	EN2	Enable Input (regulator 2). Active High Input. Logic High = On; Logic Low = Off; Do not leave floating.
4	6	EN1	Enable Input (regulator 1). Active High Input. Logic High = On; Logic Low = Off; Do not leave floating.
5	5	VOUT2	Regulator Output – LDO2
6	4	VOUT1	Regulator Output – LDO1
HS Pad	–	EPAD	Exposed heatsink pad connected to ground internally.

Absolute Maximum Ratings⁽¹⁾

Supply Voltage (V_{IN}).....	0V to +6V
Enable Input Voltage (V_{EN}).....	0V to +6V
Power Dissipation.....	Internally Limited ⁽³⁾
Lead Temperature (soldering, 3sec).....	260°C
Storage Temperature (T_S).....	-65°C to +150°C
ESD Rating ⁽⁴⁾	2kV

Operating Ratings⁽²⁾

Supply Voltage (V_{IN}).....	+2.3V to +5.5V
Enable Input Voltage (V_{EN}).....	0V to V_{IN}
Junction Temperature (T_J)	-40°C to +125°C
Junction Thermal Resistance	
Thin MLF-6 / MLF-6 (θ_{JA})	100°C/W
TSOT-6 (θ_{JA})	235°C/W

Electrical Characteristics⁽⁵⁾

$V_{IN} = EN1 = EN2 = V_{OUT} + 1.0V$; higher of the two regulator outputs, $I_{OUTLDO1} = I_{OUTLDO2} = 100\mu A$; $C_{OUT1} = C_{OUT2} = 1\mu F$; $T_J = 25^\circ C$, **bold** values indicate $-40^\circ C \leq T_J \leq +125^\circ C$, unless noted.

Parameter	Conditions	Min	Typ	Max	Units
Output Voltage Accuracy	Variation from nominal V_{OUT}	-2.0		+2.0	%
	Variation from nominal V_{OUT} ; $-40^\circ C$ to $+125^\circ C$	-3.0		+3.0	%
Line Regulation	$V_{IN} = V_{OUT} + 1V$ to 5.5V; $I_{OUT} = 100\mu A$		0.02	0.3 0.6	%/V %/V
Load Regulation	$I_{OUT} = 100\mu A$ to 150mA		0.5	2	%
Dropout Voltage ⁽⁶⁾	$I_{OUT} = 100\mu A$		0.1		mV
	$I_{OUT} = 50mA$		12	50	mV
	$I_{OUT} = 100mA$		25	75	mV
	$I_{OUT} = 150mA$		35	100	mV
Ground Current	EN1 = High; EN2 = Low; $I_{OUT} = 100\mu A$ to 150mA		85	120	μA
	EN1 = Low; EN2 = High; $I_{OUT} = 100\mu A$ to 150mA		85	120	μA
	EN1 = EN2 = High; $I_{OUT1} = 150mA$, $I_{OUT2} = 150mA$		150	190	μA
Ground Current in Shutdown	EN1 = EN2 = 0V		0.01	2	μA
Ripple Rejection	f = 1kHz; $C_{OUT} = 1.0\mu F$		65		dB
	f=20kHz; $C_{OUT} = 1.0\mu F$		45		dB
Current Limit	$V_{OUT} = 0V$	300	550	950	mA
Output Voltage Noise	$C_{OUT} = 1.0\mu F$; 10Hz to 100KHz		90		μV_{RMS}
Enable Inputs (EN1 / EN2)					
Enable Input Voltage	Logic Low			0.2	V
	Logic High	1.1			V
Enable Input Current	$V_{IL} \leq 0.2V$		0.01	1	μA
	$V_{IH} \geq 1.0V$		0.01	1	μA
Turn-on Time (See Timing Diagram)					
Turn-on Time (LDO1 and 2)	$C_{OUT} = 1.0\mu F$		30	100	μs

Notes:

- Exceeding the absolute maximum rating may damage the device.
- The device is not guaranteed to function outside its operating rating.
- The maximum allowable power dissipation of any T_A (ambient temperature) is $P_{D(max)} = T_{J(max)} - T_A / \theta_{JA}$. Exceeding the maximum allowable power dissipation will result in excessive die temperature, and the regulator will go into thermal shutdown.
- Devices are ESD sensitive. Handling precautions recommended. Human body model, 1.5k in series with 100pF.
- Specification for packaged product only.
- Dropout voltage is defined as the input-to-output differential at which the output voltage drops 2% below its nominal V_{OUT} . For outputs below 2.3V, the dropout voltage is the input-to-output differential with the minimum input voltage 2.3V.

Functional Diagram

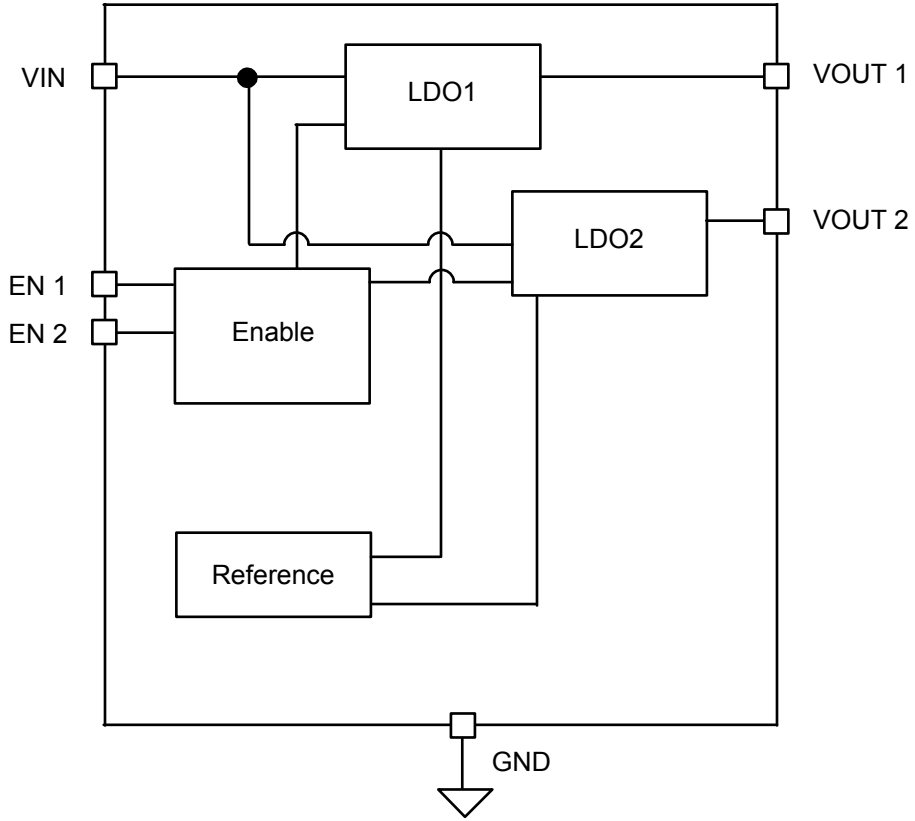

MIC5320 Block Diagram

Typical Characteristics

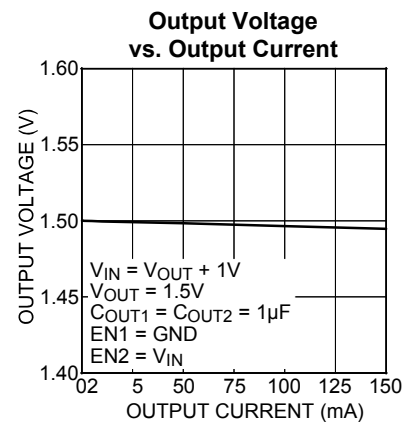
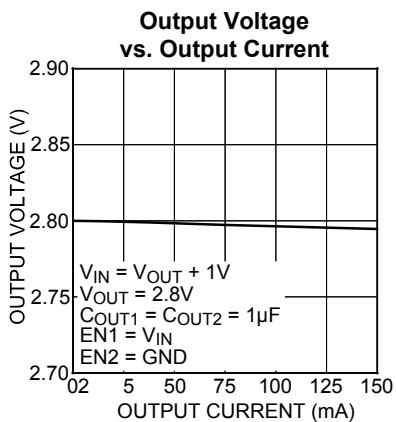
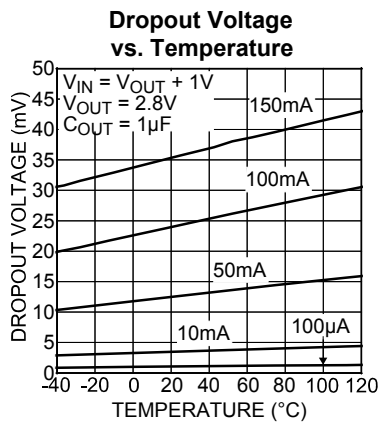
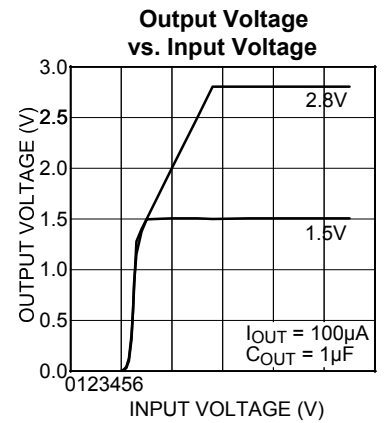
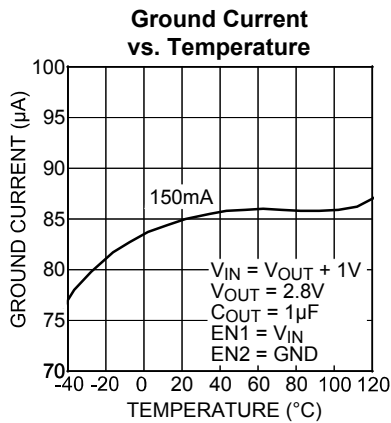
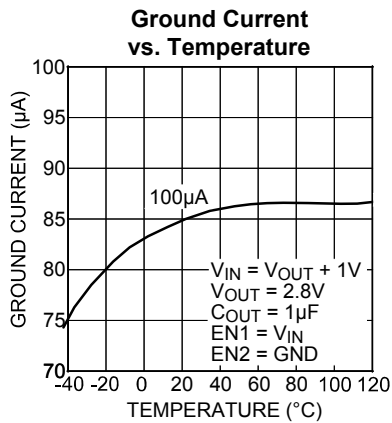
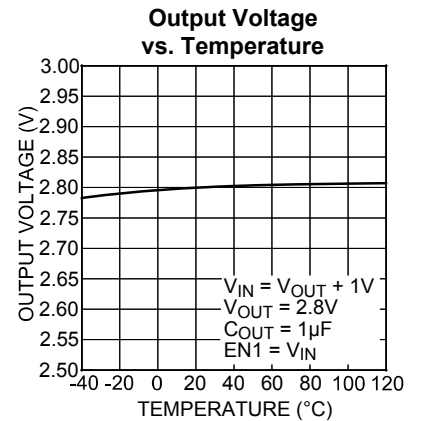
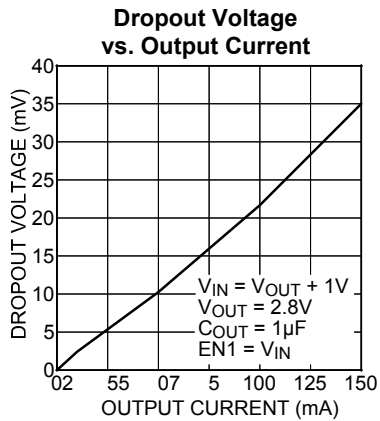
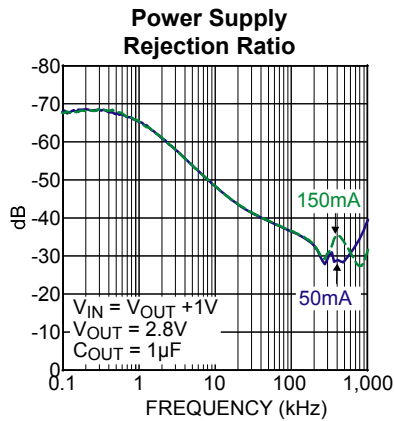

Typical Characteristics (Continued)

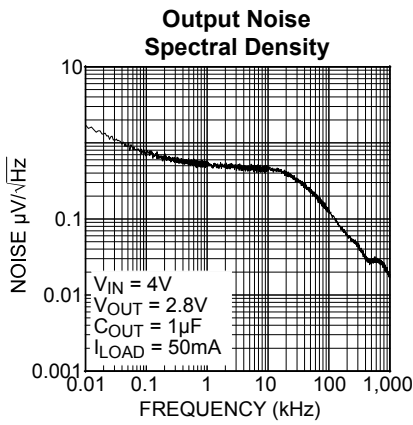

Functional Characteristics

Enable Turn-On



Load Transient



Line Transient



Applications Information

Enable/Shutdown

The MIC5320 comes with dual active-high enable pins that allow each regulator to be disabled independently. Forcing the enable pin low disables the regulator and sends it into a “zero” off-mode-current state. In this state, current consumed by the regulator goes nearly to zero. Forcing the enable pin high enables the output voltage. The active-high enable pin uses CMOS technology and the enable pin cannot be left floating; a floating enable pin may cause an indeterminate state on the output.

Input Capacitor

The MIC5320 is a high-performance, high bandwidth device. Therefore, it requires a well-bypassed input supply for optimal performance. A 1 μ F capacitor is required from the input to ground to provide stability. Low-ESR ceramic capacitors provide optimal performance at a minimum of space. Additional high-frequency capacitors, such as small-valued NPO dielectric-type capacitors, help filter out high-frequency noise and are good practice in any RF-based circuit.

Output Capacitor

The MIC5320 requires an output capacitor of 1 μ F or greater to maintain stability. The design is optimized for use with low-ESR ceramic chip capacitors. High ESR capacitors may cause high frequency oscillation. The output capacitor can be increased, but performance has been optimized for a 1 μ F ceramic output capacitor and does not improve significantly with larger capacitance.

X7R/X5R dielectric-type ceramic capacitors are recommended because of their temperature performance. X7R-type capacitors change capacitance by 15% over their operating temperature range and are the most stable type of ceramic capacitors. Z5U and Y5V dielectric capacitors change value by as much as 50% and 60%, respectively, over their operating temperature ranges. To use a ceramic chip capacitor with Y5V dielectric, the value must be much higher than an X7R ceramic capacitor to ensure the same minimum capacitance over the equivalent operating temperature range.

No-Load Stability

Unlike many other voltage regulators, the MIC5320 will remain stable and in regulation with no load. This is especially important in CMOS RAM keep-alive applications.

Thermal Considerations

The MIC5320 is designed to provide 150mA of continuous current for both outputs in a very small package. Maximum ambient operating temperature can be calculated based on the output current and the voltage drop across the part. Given that the input voltage is 3.3V, the output voltage is 2.8V for V_{OUT1} , 1.5V for V_{OUT2} and the output current = 150mA. The actual power dissipation of the regulator circuit can be determined using the equation:

$$P_D = (V_{IN} - V_{OUT1}) I_{OUT1} + (V_{IN} - V_{OUT2}) I_{OUT2} + V_{IN} I_{GND}$$

Because this device is CMOS and the ground current is typically <150 μ A over the load range, the power dissipation contributed by the ground current is < 1% and can be ignored for this calculation.

$$P_D = (3.3V - 2.8V) \times 150mA + (3.3V - 1.5V) \times 150mA$$

$$P_D = 0.345W$$

To determine the maximum ambient operating temperature of the package, use the junction-to-ambient thermal resistance of the device and the following basic equation:

$$P_{D(MAX)} = \left(\frac{T_{J(MAX)} - T_A}{\theta_{JA}} \right)$$

$T_{J(max)} = 125^\circ\text{C}$, the maximum junction temperature of the die θ_{JA} thermal resistance = 100 $^\circ\text{C/W}$.

The table below shows junction-to-ambient thermal resistance for the MIC5320 in different packages.

Package	θ_{JA} Recommended Minimum Footprint	θ_{JC}
6-Pin 1.6x1.6 Thin MLF [®]	100 $^\circ\text{C/W}$	2 $^\circ\text{C/W}$

Thermal Resistance

Substituting P_D for $P_{D(max)}$ and solving for the ambient operating temperature will give the maximum operating conditions for the regulator circuit. The junction-to-ambient thermal resistance for the minimum footprint is $100^{\circ}\text{C}/\text{W}$.

The maximum power dissipation must not be exceeded for proper operation.

For example, when operating the MIC5320-MFYMT at an input voltage of 3.3V and 150mA loads at each output with a minimum footprint layout, the maximum ambient operating temperature T_A can be determined as follows:

$$0.345\text{W} = (125^{\circ}\text{C} - T_A)/(100^{\circ}\text{C}/\text{W})$$

$$T_A = 90.5^{\circ}\text{C}$$

Therefore, a 2.8V/1.5V application with 150mA at each output current can accept an ambient operating temperature of 90.5°C in a 1.6mm x 1.6mm Thin MLF[®] package. For a full discussion of heat sinking and thermal effects on voltage regulators, refer to the "Regulator Thermals" section of *Micrel's Designing with Low-Dropout Voltage Regulators* handbook. This information can be found on Micrel's website at:

http://www.micrel.com/_PDF/other/LDOBk_ds.pdf

Package Information

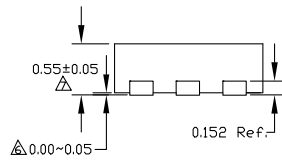

NOTE:
 1. ALL DIMENSIONS ARE IN MILLIMETERS.
 2. MAX. PACKAGE WARPAGE IS 0.05 mm.
 3. MAXIMUM ALLOWABLE BURRS IS 0.076 mm IN ALL DIRECTIONS.
 4. PIN #1 ID ON TOP WILL BE LASER/INK MARKED.
 △ DIMENSION APPLIES TO METALIZED TERMINAL AND IS MEASURED BETWEEN 0.20 AND 0.25 mm FROM TERMINAL TIP.
 △ APPLIED ONLY FOR TERMINALS.
 △ APPLIED FOR EXPOSED PAD AND TERMINALS.

SIDE VIEW

6-Pin 1.6mm x 1.6mm Thin MLF (MT)

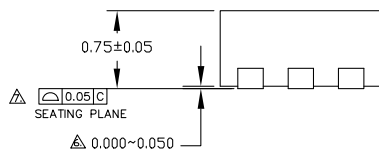
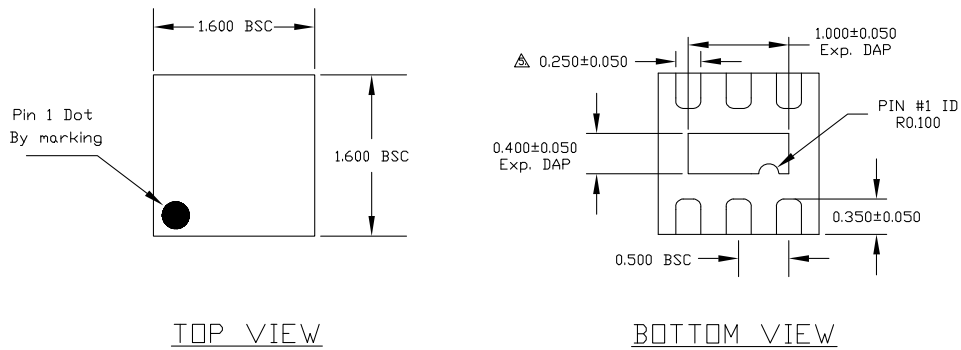

NOTE:
 1. ALL DIMENSIONS ARE IN MILLIMETERS.
 2. MAX. PACKAGE WARPAGE IS 0.05 mm.
 3. MAXIMUM ALLOWABLE BURRS IS 0.076 mm IN ALL DIRECTIONS.
 4. PIN #1 ID ON TOP WILL BE LASER/INK MARKED.
 △ DIMENSION APPLIES TO METALIZED TERMINAL AND IS MEASURED BETWEEN 0.20 AND 0.25 mm FROM TERMINAL TIP.
 △ APPLIED ONLY FOR TERMINALS.
 △ APPLIED FOR EXPOSED PAD AND TERMINALS.

SIDE VIEW

6-Pin 1.6mm x 1.6mm MLF (ML)



NOTE:

1. Dimensions and tolerances are as per ANSI Y14.5M, 1994.
2. Die is facing up for mold. Die is facing down for trim/form, ie. reverse trim/form.
3. Dimensions are exclusive of mold flash and gate burr.
4. The footlength measuring is based on the gauge plane method.
5. All specification comply to Jedec Spec M0193 Issue C.
6. All dimensions are in millimeters.

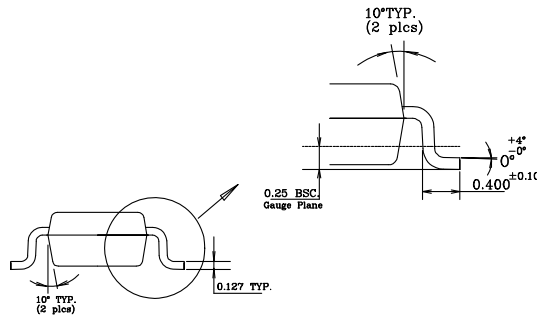

6-Pin TSOT-23 (D6)

MICREL, INC. 2180 FORTUNE DRIVE SAN JOSE, CA 95131 USA

TEL +1 (408) 944-0800 FAX +1 (408) 474-1000 WEB <http://www.micrel.com>

Micrel makes no representations or warranties with respect to the accuracy or completeness of the information furnished in this data sheet. This information is not intended as a warranty and Micrel does not assume responsibility for its use. Micrel reserves the right to change circuitry, specifications and descriptions at any time without notice. No license, whether express, implied, arising by estoppel or otherwise, to any intellectual property rights is granted by this document. Except as provided in Micrel's terms and conditions of sale for such products, Micrel assumes no liability whatsoever, and Micrel disclaims any express or implied warranty relating to the sale and/or use of Micrel products including liability or warranties relating to fitness for a particular purpose, merchantability, or infringement of any patent, copyright or other intellectual property right.

Micrel Products are not designed or authorized for use as components in life support appliances, devices or systems where malfunction of a product can reasonably be expected to result in personal injury. Life support devices or systems are devices or systems that (a) are intended for surgical implant into the body or (b) support or sustain life, and whose failure to perform can be reasonably expected to result in a significant injury to the user. A Purchaser's use or sale of Micrel Products for use in life support appliances, devices or systems is a Purchaser's own risk and Purchaser agrees to fully indemnify Micrel for any damages resulting from such use or sale.

© 2006 Micrel, Incorporated.

Looking for pricing, stock, or lifecycle information?

Click below to explore more details on WIN SOURCE:

- ⊖ [View MIC5320-MGYMT-TR on WIN SOURCE](#)
- ⊖ [Microchip Technology](#) Information

Optimize Your Supply Chain with WIN SOURCE Solutions

- ✓ Global Sourcing Solution
- ✓ Obsolete Management
- ✓ Cost Control Management
- ✓ Shortage Management
- ✓ Alternative Solution
- ✓ Excess Inventory Management