

High Performance Low Dropout 150 mA LDO

Features

- 4-Lead 1 mm x 1 mm Thin DFN: MIC5376
- 8-Lead 1.2 mm x 1.2 mm Thin QFN: MIC5377/8
- Low-Cost 5-Lead SC-70 Package Available
- Low Dropout Voltage: 120 mV at 150 mA
- Input Voltage Range: 2.5V to 5.5V
- 150 mA Guaranteed Output Current
- Stable with 0402 Ceramic Capacitors as Low as 1 μ F
- Low Quiescent Current: 29 μ A
- Excellent Load/Line Transient Response
- Fixed Output Voltages: MIC5376
- Adjustable Output Voltages: MIC5377/8
- Output Discharge Circuit: MIC5376/8
- High Output Accuracy
 - $\pm 2\%$ Initial Accuracy
- Thermal Shutdown and Current Limit Protection

Applications

- Mobile Phones
- Digital Cameras
- GPS, PDAs, PMP, Handhelds
- Portable Electronics

General Description

The MIC5376, MIC5377, and MIC5378 are advanced, general purpose linear regulators that offer low dropout in ultra-small packages. The MIC5376 provides a fixed output voltage in a 1 mm x 1 mm Thin DFN package while the MIC5377 and MIC5378 provide adjustable output voltages in a 1.2 mm x 1.2 mm Thin QFN package. When the MIC5376 or MIC5378 are disabled, an internal resistive load is automatically applied to the output to discharge the output capacitor. The MIC5376/7/8 are capable of sourcing 150 mA output current with low dropout, making it an ideal solution for any portable electronic application.

Ideal for battery-powered applications, the MIC5376/7/8 offer 2% initial accuracy, low dropout voltage (120 mV at 150 mA), and ground current (typically 29 μ A). The MIC5376/7/8 can also be put into a zero-off-mode current state, drawing virtually no current when disabled.

The MIC5376 is available in lead-free (RoHS compliant) 1 mm x 1 mm Thin DFN and SC-70-5 packages. The MIC5377/8 are available in lead-free (RoHS compliant) 1.2 mm x 1.2 mm Thin QFN and SC-70-5 packages.

The MIC5376/7/8 have an operating junction temperature range of -40°C to 125°C .

Typical Application Circuit

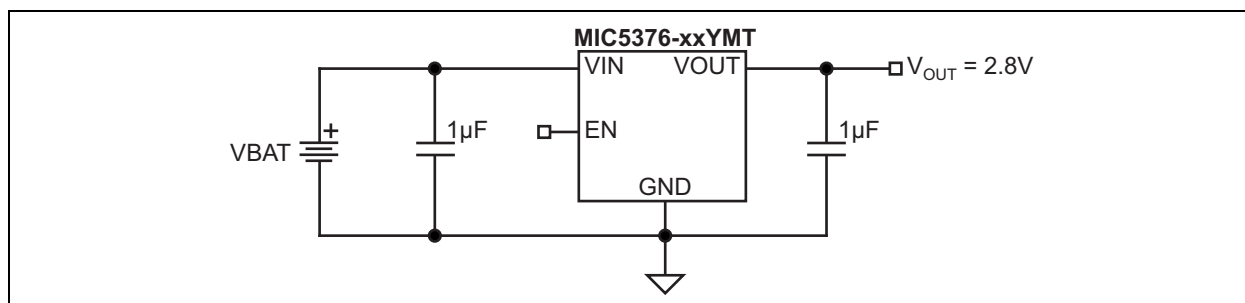

MIC5376/7/8

Package Types

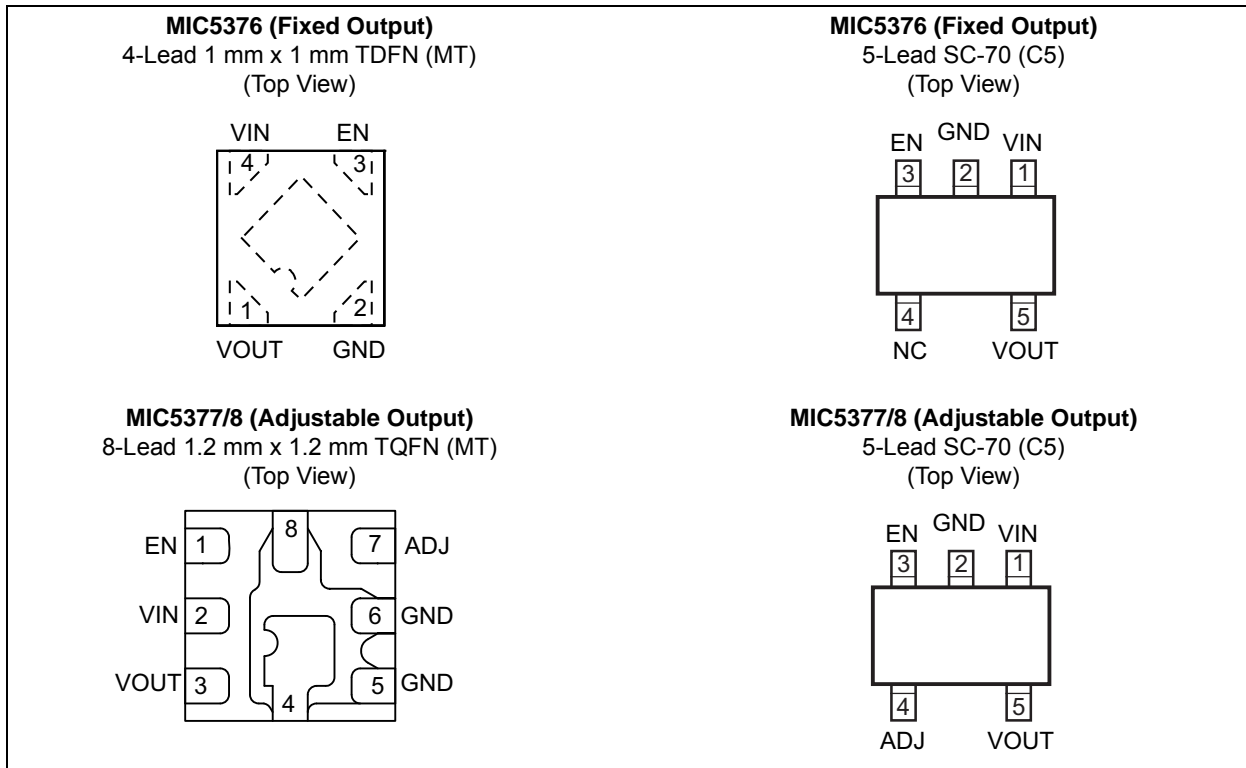

Functional Block Diagram

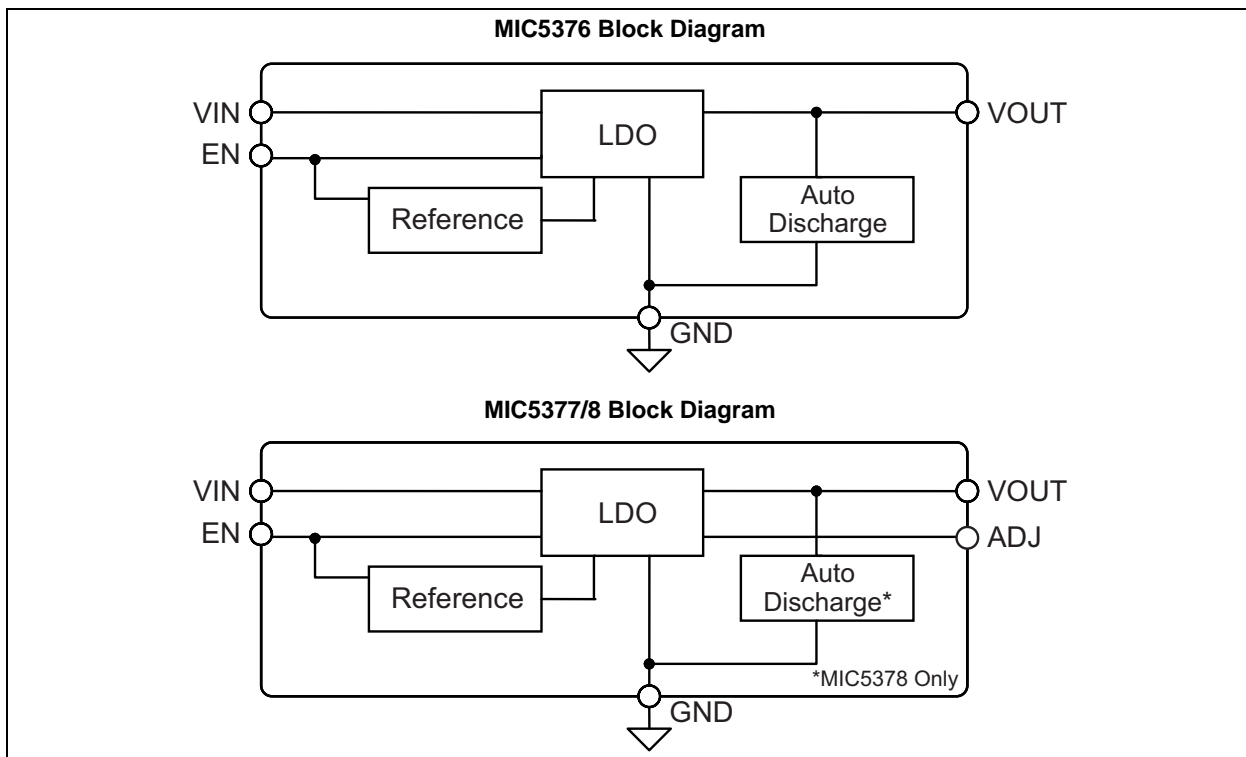

1.0 ELECTRICAL CHARACTERISTICS

Absolute Maximum Ratings †

Supply Voltage (V_{IN})	0V to +6V
Enable Voltage (V_{EN})	0V to V_{IN}
Power Dissipation (P_D) (Note 1)	Internally Limited
Lead Temperature (Soldering, 5 sec.)	+260°C
Junction Temperature (T_J)	-40°C to +125°C
Storage Temperature (T_S)	-65°C to +150°C
ESD Rating (Note 2)	2 kV

Operating Ratings ††

Supply Voltage (V_{IN})	2.5V to 5.5V
Enable Voltage (V_{EN})	0V to V_{IN}
Junction Temperature (T_J)	-40°C to +125°C
Package Thermal Resistance	
1 mm x 1 mm TDFN-4 (θ_{JA})	250°C/W
1.2 mm x 1.2 mm TQFN-8 (θ_{JA})	250°C/W
SC-70-5 (θ_{JA})	256.5°C/W

† Notice: Stresses above those listed under “Absolute Maximum Ratings” may cause permanent damage to the device. This is a stress rating only and functional operation of the device at those or any other conditions above those indicated in the operational sections of this specification is not intended. Exposure to maximum rating conditions for extended periods may affect device reliability.

†† Notice: The device is not guaranteed to function outside its operating ratings.

- Note 1:** The maximum allowable power dissipation of any T_A (ambient temperature) is $P_{D(MAX)} = (T_{J(MAX)} - T_A) / \theta_{JA}$. Exceeding the maximum allowable power dissipation will result in excessive die temperature, and the regulator will go into thermal shutdown.
- 2:** Devices are ESD sensitive. Handling precautions are recommended. Human body model, 1.5 k Ω in series with 100pF.

MIC5376/7/8

ELECTRICAL CHARACTERISTICS

Electrical Characteristics: $V_{IN} = V_{EN} = V_{OUT} + 1V$; $C_{IN} = C_{OUT} = 1 \mu F$ for $V_{OUT} \geq 2.5V$, $C_{IN} = C_{OUT} = 2.2 \mu F$ for $V_{OUT} < 2.5V$; $I_{OUT} = 100 \mu A$; $T_J = +25^\circ C$, **bold** values indicate $-40^\circ C$ to $+125^\circ C$, unless noted. [Note 1](#)

Parameter	Sym.	Min.	Typ.	Max.	Units	Conditions
Output Voltage Accuracy	V_{OUT}	-2.0	—	2.0	%	Variation from nominal V_{OUT}
		-3.0	—	3.0		
Line Regulation	$\frac{\Delta V_{OUT}}{V_{OUT}}$	—	0.02	0.3	%	$V_{IN} = V_{OUT} + 1V$ to 5.5V; $I_{OUT} = 100 \mu A$
Load Regulation (Note 2)	$\frac{\Delta V_{OUT}}{V_{OUT}}$	—	0.3	1.0	%	$I_{OUT} = 100 \mu A$ to 150 mA
Dropout Voltage (Note 3)	V_{DO}	—	45	100	mV	$I_{OUT} = 50$ mA
		—	120	200		$I_{OUT} = 150$ mA
Ground Pin Current (Note 4)	I_{GND}	—	29	45	μA	$I_{OUT} = 0$ mA
Ground Pin Current in Shutdown	$I_{GND-SHDN}$	—	0.05	1	μA	$V_{EN} \leq 0.2V$
Ripple Rejection	PSRR	—	60	—	dB	$f = 1$ kHz; $C_{OUT} = 1 \mu F$
		—	50	—		$f = 10$ kHz; $C_{OUT} = 1 \mu F$
Current Limit	I_{LIM}	200	370	550	mA	$V_{OUT} = 0V$
Output Voltage Noise	e_n	—	200	—	μV_{RMS}	$C_{OUT} = 1 \mu F$, 10 Hz to 100 kHz
Auto-Discharge NFET Resistance	$R_{DS(ON)}$	—	30	—	Ω	$V_{EN} = 0V$; $V_{IN} = 3.6V$
Reference Voltage (MIC5377/8)						
Reference Voltage Accuracy	V_{REF}	0.97	1	1.03	V	—
Adjust Pin Input Current	$I_{ADJ-BIAS}$	—	0.01	—	μA	—
Enable Input						
Enable Input Voltage	V_{EN}	—	—	0.2	V	Logic low.
		1.2	—	—		Logic high.
Enable Input Current	I_{EN}	—	0.01	1	μA	$V_{IL} \leq 0.2V$
		—	0.01	1		$V_{IH} \geq 1.2V$
Turn-On Time	t_{ON}	—	45	100	μs	$C_{OUT} = 1 \mu F$; $I_{OUT} = 150$ mA

Note 1: Specification for packaged product only.

2: Regulation is measured at constant junction temperature using low duty cycle pulse testing.

3: Dropout voltage is defined as the input-to-output differential at which the output voltage drops 2% below its nominal value measured at 1V differential. For outputs below 2.5V, dropout voltage is the input-to-output differential with the minimum input voltage 2.5V.

4: Ground pin current is the regulator quiescent current. The total current drawn from the supply is the sum of the load current plus the ground pin current.

TEMPERATURE SPECIFICATIONS

Parameters	Sym.	Min.	Typ.	Max.	Units	Conditions
Temperature Ranges						
Junction Temperature Range	T_J	-40	—	+125	°C	—
Lead Temperature	—	—	—	+260	°C	Soldering, 5 sec.
Storage Temperature	T_S	-65	—	+150	°C	—
Package Thermal Resistances						
Thermal Resistance, 1x1 TDFN 4-Ld	θ_{JA}	—	250	—	°C/W	—
Thermal Resistance, 1.2x1.2 TQFN 8-Ld	θ_{JA}	—	250	—	°C/W	—
Thermal Resistance, SC-70-5	θ_{JA}	—	256.5	—	°C/W	—

Note 1: The maximum allowable power dissipation is a function of ambient temperature, the maximum allowable junction temperature and the thermal resistance from junction to air (i.e., T_A , T_J , θ_{JA}). Exceeding the maximum allowable power dissipation will cause the device operating junction temperature to exceed the maximum +125°C rating. Sustained junction temperatures above +125°C can impact the device reliability.

MIC5376/7/8

2.0 TYPICAL PERFORMANCE CURVES

Note: The graphs and tables provided following this note are a statistical summary based on a limited number of samples and are provided for informational purposes only. The performance characteristics listed herein are not tested or guaranteed. In some graphs or tables, the data presented may be outside the specified operating range (e.g., outside specified power supply range) and therefore outside the warranted range.

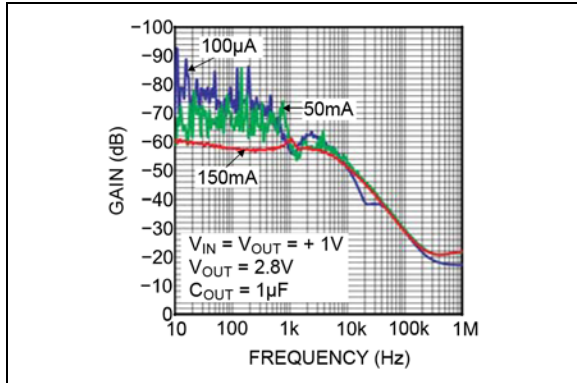

FIGURE 2-1: Power Supply Rejection Ratio.

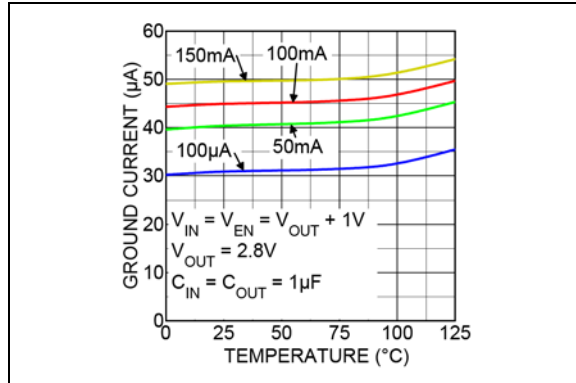

FIGURE 2-4: Ground Current vs. Temperature.

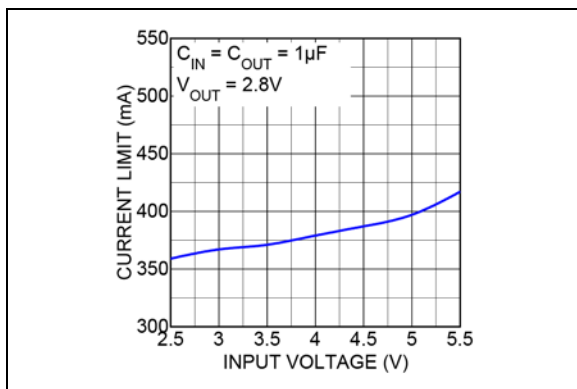

FIGURE 2-2: Current Limit vs. Input Voltage.

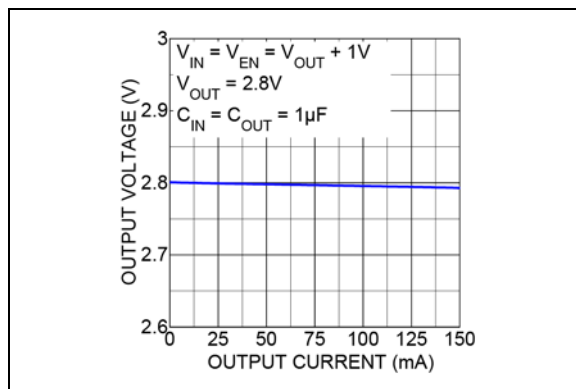

FIGURE 2-5: Output Voltage vs. Load Current.

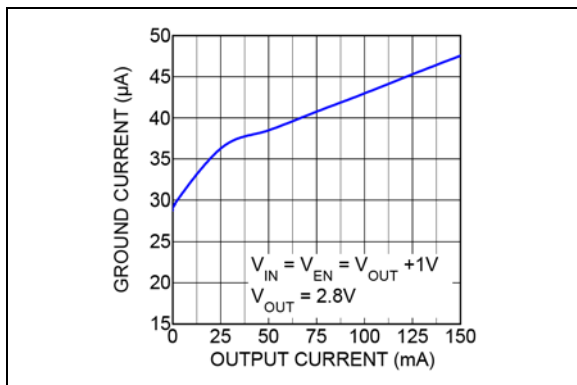

FIGURE 2-3: Ground Current vs. Output Current.

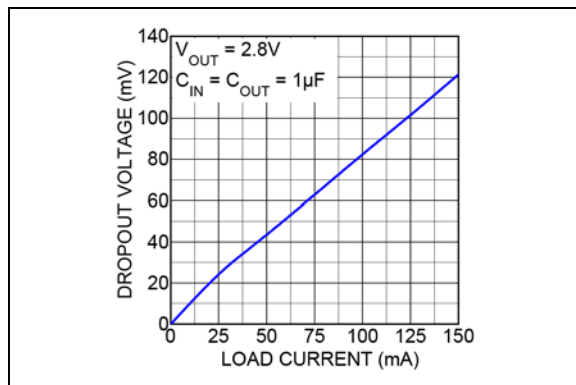

FIGURE 2-6: Dropout Voltage vs. Load Current.

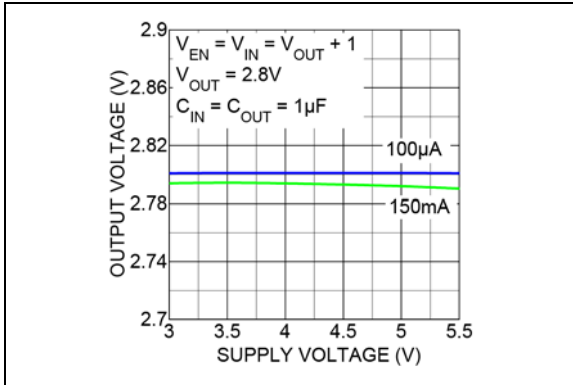

FIGURE 2-7: Output Voltage vs Supply Voltage.

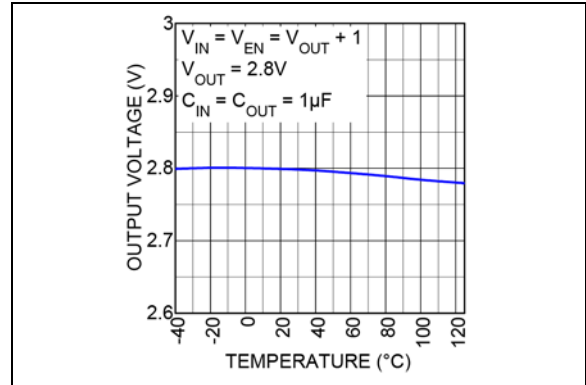

FIGURE 2-10: Output Voltage vs Temperature.

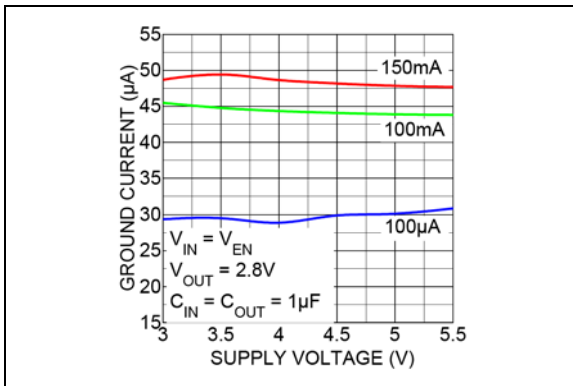

FIGURE 2-8: Ground Current vs Supply Voltage.

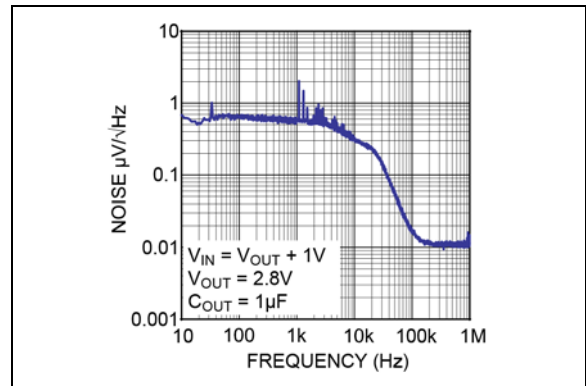

FIGURE 2-11: Output Noise Spectral Density.

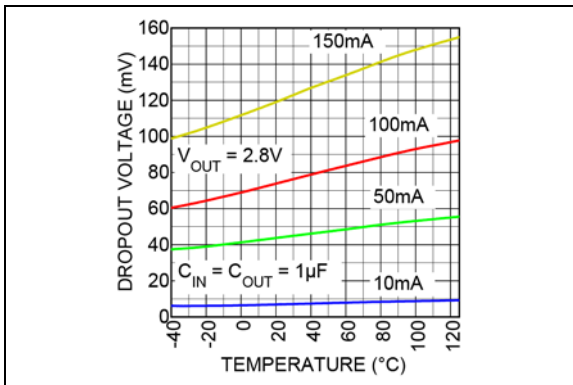

FIGURE 2-9: Dropout Voltage vs Temperature.

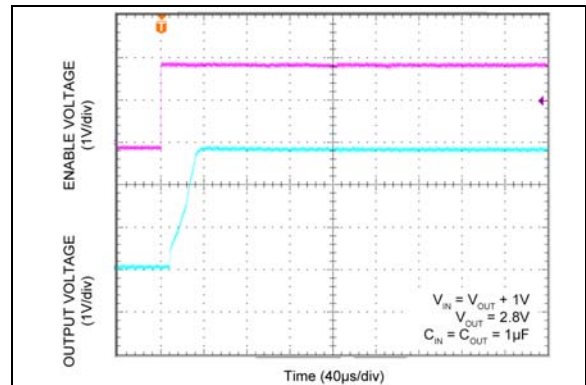

FIGURE 2-12: Enable Turn-On.

MIC5376/7/8

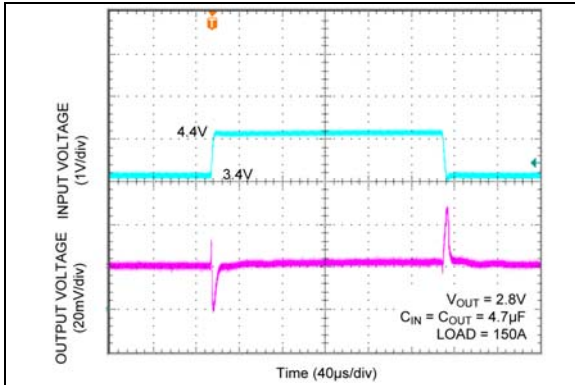

FIGURE 2-13: Line Transient 2.8V (3.4V to 4.4V).

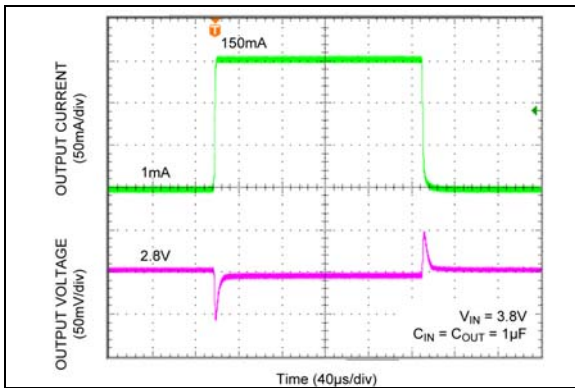

FIGURE 2-14: Load Transient 2.8V (1 mA to 150 mA).

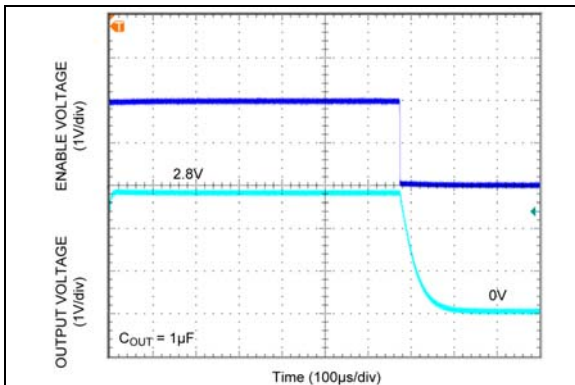

FIGURE 2-15: MIC5376 Auto-Discharge (No Load).

3.0 PIN DESCRIPTIONS

The descriptions of the pins are listed in [Table 3-1](#).

TABLE 3-1: PIN FUNCTION TABLE

Pin Number MIC5376 TDFN 4-Ld	Pin Number MIC5376 SC-70-5	Pin Number MIC5377/8 TQFN 8-Ld	Pin Number MIC5377/8 SC-70-5	Pin Name	Description
3	3	1	3	EN	Enable Input. Active-High. High = on, low = off. Do not leave floating.
4	1	2	1	VIN	Supply Input.
1	5	3	5	VOUT	Output Voltage.
2	2	4, 5, 6, 8	2	GND	Ground.
—	—	7	4	ADJ	Adjust Pin: Feedback input from external divider.
—	4	—	—	NC	No connection.
HS Pad	—	—	—	ePAD	Exposed Heat Sink Pad. Connected to ground internally.

MIC5376/7/8

4.0 APPLICATION INFORMATION

MIC5376, MIC5377, and MIC5378 are low-noise 150 mA LDO regulators. The MIC5376 and MIC5378 include an auto-discharge circuit that is switched on when the regulator is disabled through the enable pin. The MIC5376/7/8 regulators are protected from damage due to fault conditions, offering linear current limiting and thermal shutdown.

4.1 Input Capacitor

The MIC5376/7/8 are high-performance, high bandwidth devices. An input capacitor of 1 μ F is required from the input to ground to provide stability. Low-ESR ceramic capacitors provide optimal performance at a minimum of space. Additional high-frequency capacitors, such as small-valued NPO dielectric-type capacitors, help filter out high-frequency noise and are good practice in any RF-based circuit. X5R or X7R dielectrics are recommended for the input capacitor. Y5V dielectrics lose most of their capacitance over temperature and are, therefore, not recommended.

4.2 Output Capacitor

For output voltages ≥ 2.5 V, the MIC5376/7/8 require a minimum 1 μ F output capacitor. For output voltages below 2.5V, a 2.2 μ F minimum output capacitor is required. The design is optimized for use with low-ESR ceramic chip capacitors. High-ESR capacitors are not recommended because they may cause high frequency oscillation. The output capacitor can be increased, but performance does not improve significantly with larger capacitance.

X7R/X5R dielectric-type ceramic capacitors are recommended because of their temperature performance. X7R-type capacitors change capacitance by 15% over their operating temperature range and are the most stable type of ceramic capacitors. Z5U and Y5V dielectric capacitors change value by as much as 50% and 60%, respectively, over their operating temperature ranges. To use a ceramic chip capacitor with Y5V dielectric, the value must be much higher than an X7R ceramic capacitor to ensure the same minimum capacitance over the equivalent operating temperature range.

4.3 No-Load Stability

Unlike many other voltage regulators, the MIC5376/7/8 will remain stable and in regulation with no load. This is especially important in CMOS RAM keep-alive applications.

4.4 Enable/Shutdown

The MIC5376/7/8 is provided with an active-high enable pin that allows the regulator to be disabled. Forcing the enable pin low disables the regulator and sends it into a “zero” off-mode-current state. In this state, current consumed by the regulator goes nearly to zero. Forcing the enable pin high enables the output voltage. The active-high enable pin uses CMOS technology and the enable pin cannot be left floating; a floating enable pin may cause an indeterminate state on the output.

4.5 Adjustable Regulator Design

The MIC5377/8 adjustable version allows setting the output voltage down to 1V with the use of two external feedback resistors.

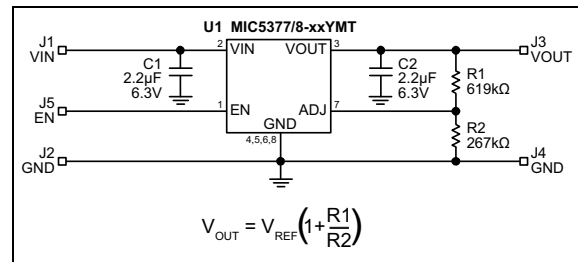

FIGURE 4-1: Adjustable Regulator with Resistors.

4.6 Thermal Considerations

The MIC5376/7/8 are designed to provide 150 mA of continuous current in a very small package. Maximum ambient operating temperature can be calculated based on the output current and the voltage drop across the part. For example if the input voltage is 3.6V, the output voltage is 2.8V, and the output current is 150 mA, the actual power dissipation of the regulator circuit can be determined using the following equation:

EQUATION 4-1:

$$P_D = (V_{IN} - V_{OUT}) \times I_{OUT} + V_{IN} \times I_{GND}$$

Because these devices are CMOS and the ground current is typically $<100 \mu$ A over the load range, the power dissipation contributed by the ground current is $<1\%$ and can be ignored for this calculation.

EQUATION 4-2:

$$P_D = (3.6V - 2.8V) \times 150mA = 0.12W$$

To determine the maximum ambient operating temperature of the package, use the junction-to-ambient thermal resistance of the device and the following basic equation:

EQUATION 4-3:

$$P_{D(MAX)} = \frac{T_{J(MAX)} - T_A}{\theta_{JA}}$$

The maximum junction temperature of the device is +125°C. The thermal resistance is 250°C/W for the TDFN/TQFN packages and 256.5°C/W for the SC-70-5.

Substituting P_D for $P_{D(MAX)}$ and solving for the ambient operating temperature will give the maximum operating conditions for the regulator circuit. The junction-to-ambient thermal resistance for the minimum footprint is 250°C/W.

The maximum power dissipation must not be exceeded for proper operation.

For example, when operating the MIC5376-2.8YMT at an input voltage of 3.6V and 150 mA load with a minimum footprint layout, the maximum ambient operating temperature (T_A) can be determined as follows:

EQUATION 4-4:

$$0.12W = (125^\circ C - T_A) / 250^\circ C/W$$
$$T_A = 95^\circ C$$

Therefore, a maximum ambient operating temperature of +95°C is allowed for a 1 mm x 1 mm TDFN package. For a full discussion of heat sinking and thermal effects on voltage regulators, refer to the “Regulator Thermals” section of Microchip’s [Designing with Low-Dropout Voltage Regulators](#) handbook.

MIC5376/7/8

5.0 PACKAGING INFORMATION

5.1 Package Marking Information

5-Lead SC-70*

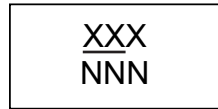

Example

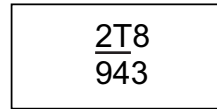

4-Lead TDFN*
8-Lead TQFN*

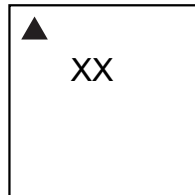

Example

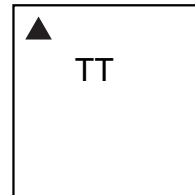

TABLE 5-1: DEVICE MARKING CODES

Part Number	Output Voltage	Marking Code
MIC5376-2.8YC5	2.8V	<u>2</u> T8
MIC5376-2.8YMT	2.8V	TT
MIC5377YC5	Adjustable	<u>A</u> HA
MIC5377YMT	Adjustable	AH
MIC5378YC5	Adjustable	<u>A</u> 67
MIC5378YMT	Adjustable	67A

<p>Legend: XX...X Product code or customer-specific information Y Year code (last digit of calendar year) YY Year code (last 2 digits of calendar year) WW Week code (week of January 1 is week '01') NNN Alphanumeric traceability code (e3) Pb-free JEDEC® designator for Matte Tin (Sn) * This package is Pb-free. The Pb-free JEDEC designator ((e3)) can be found on the outer packaging for this package.</p> <p>•, ▲, ▼ Pin one index is identified by a dot, delta up, or delta down (triangle mark).</p>
<p>Note: In the event the full Microchip part number cannot be marked on one line, it will be carried over to the next line, thus limiting the number of available characters for customer-specific information. Package may or may not include the corporate logo.</p> <p>Underbar (<u> </u>) and/or Overbar (<u> </u>) symbol may not be to scale.</p>

5-Lead SC-70 Package Outline & Recommended Land Pattern

TITLE

5 LEAD SC70 PACKAGE OUTLINE & RECOMMENDED LAND PATTERN

DRAWING # SC70-5LD-PL-1

UNIT MM

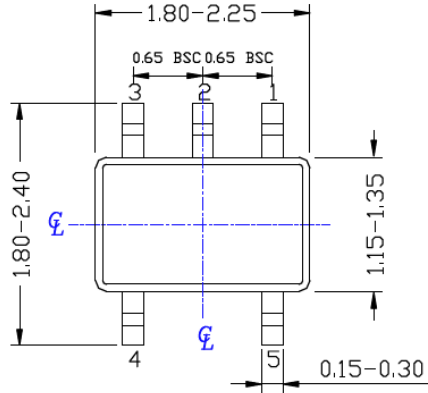

TOP VIEW

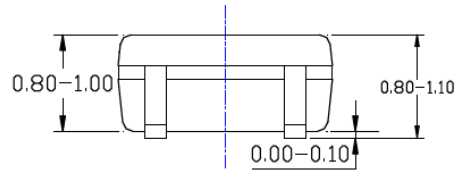

SIDE VIEW

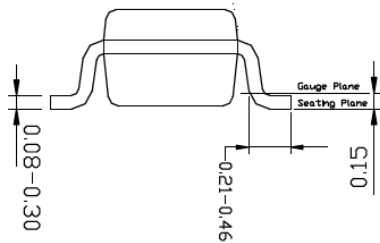

END VIEW

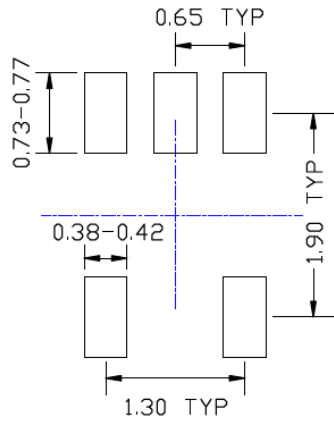

RECOMMENDED LAND PATTERN

NOTE:

1. ALL DIMENSIONS ARE IN MILLIMETERS.
2. DIMENSIONS ARE INCLUSIVE OF PLATING.
3. DIMENSIONS ARE EXCLUSIVE OF MOLD FLASH & METAL BURR.

Note: For the most current package drawings, please see the Microchip Packaging Specification located at <http://www.microchip.com/packaging>.

MIC5376/7/8

4-Lead 1 mm x 1 mm TDFN Package Outline and Recommended Land Pattern

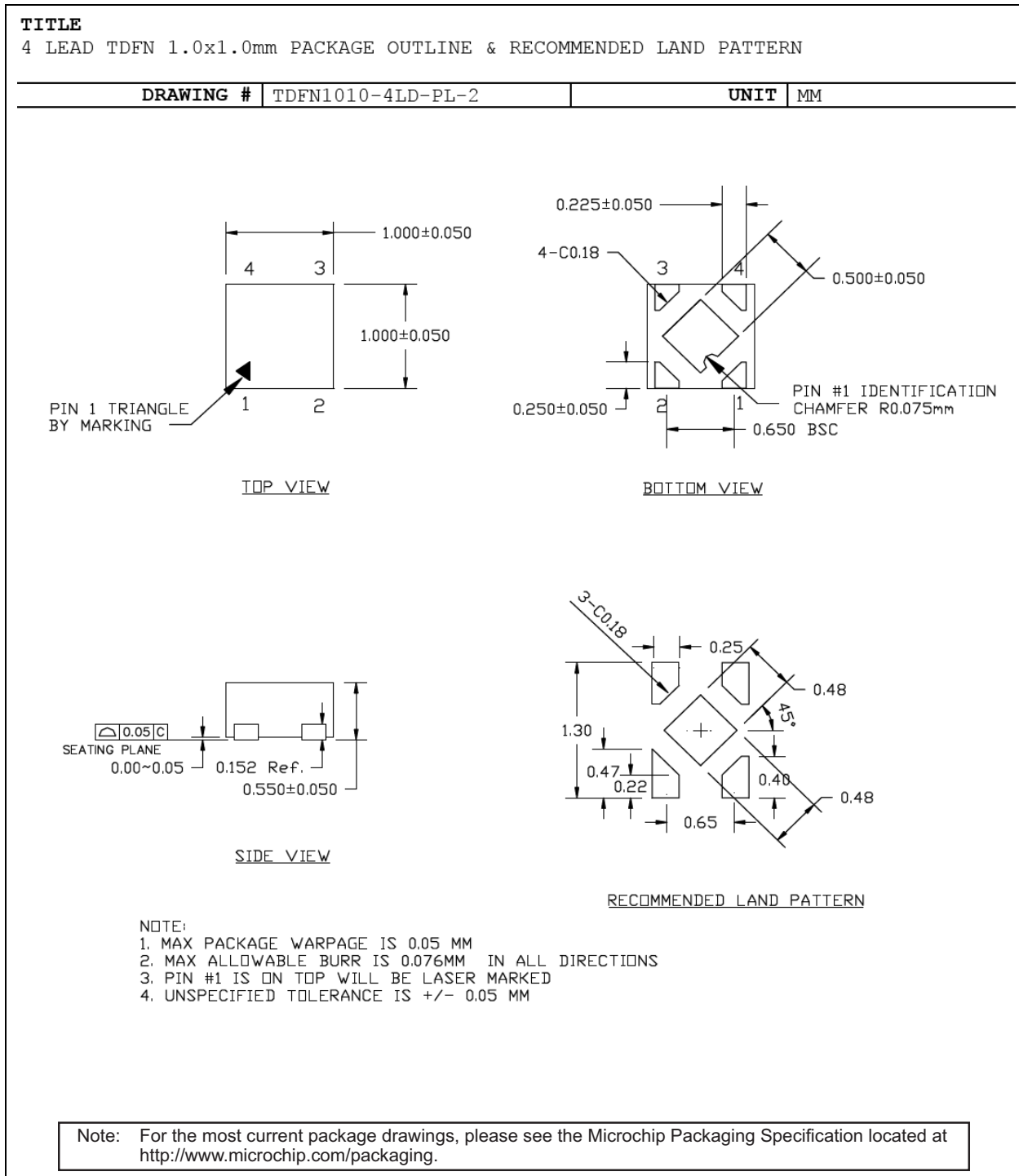

8-Lead 1.2 mm x 1.2 mm TQFN Package Outline and Recommended Land Pattern

TITLE

8 LEAD TQFN 1.2x1.2mm PACKAGE OUTLINE & RECOMMENDED LAND PATTERN

DRAWING #	TQFN1212-8LD-PL-1	UNIT	MM
-----------	-------------------	------	----

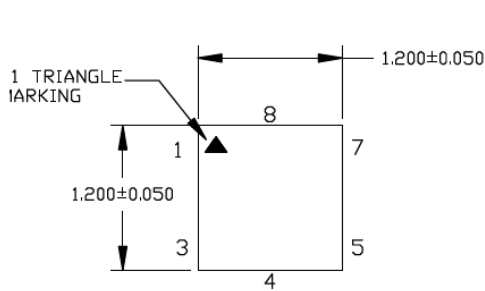

TOP VIEW

NOTE: 1, 2, 3

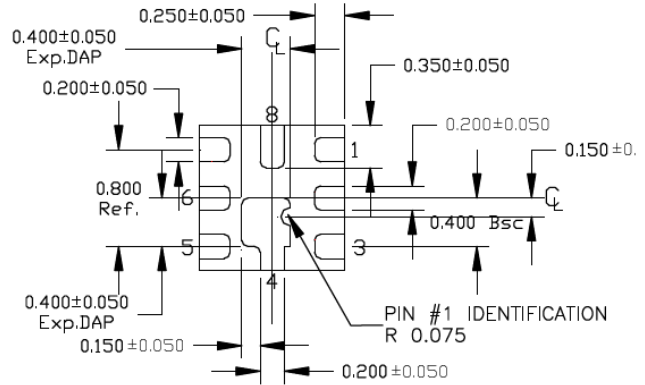

BOTTOM VIEW

NOTE: 1, 2

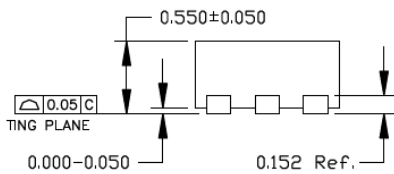

SIDE VIEW

NOTE: 1, 2

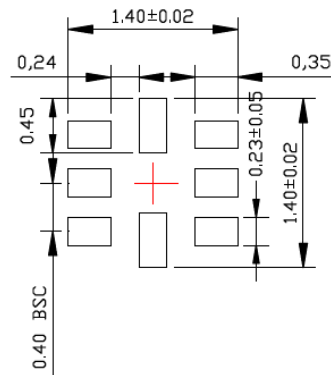

RECOMMENDED LAND PATTERN

NOTE:

1. MAX PACKAGE WARPAGE IS 0.05MM
2. MAX ALLOWABLE BURR IS 0.076MM IN ALL DIRECTIONS
3. PIN #1 IS ON TOP WILL BE LASER MARKED

Note: For the most current package drawings, please see the Microchip Packaging Specification located at <http://www.microchip.com/packaging>.

MIC5376/7/8

NOTES:

APPENDIX A: REVISION HISTORY

Revision A (October 2018)

- Converted Micrel document MIC5376/7/8 to Microchip data sheet template DS20006080A.
- Minor grammatical text changes throughout.
- All reference to and information about the MIC5375 has been removed.

MIC5376/7/8

NOTES:

PRODUCT IDENTIFICATION SYSTEM

To order or obtain information, e.g., on pricing or delivery, contact your local Microchip representative or sales office.

Device	-X.X	X	XX	-XX	
Part No.	Output Voltage	Junction Temp. Range	Package	Media Type	
Device:	MIC5376:	High Performance Low Dropout 150 mA LDO with Fixed Output Voltage and Output Discharge Circuit			
	MIC5377:	High Performance Low Dropout 150 mA LDO with Adjustable Output Voltage			
	MIC5378:	High Performance Low Dropout 150 mA LDO with Adjustable Output Voltage and Output Discharge Circuit			
Output Voltage:	2.8 =	2.8V			
	<blank>=	Adjustable			
Junction Temperature Range:	Y =	-40°C to +125°C, RoHS-Compliant			
Package:	C5 =	5-Lead SC-70 (MIC5376/7/8)			
	MT =	4-Lead 1 mm x 1 mm TDFN (MIC5376)			
	MT =	8-Lead 1.2 mm x 1.2 mm TQFN (MIC5377/8)			
Media Type:	TR =	3000/Reel (C5 package option)			
	TR =	5000/Reel (MIC5377/8 MT package options)			
	TZ =	10000/Reel (MIC5376 MT package option)			
					Examples:
					a) MIC5376-2.8YC5-TR: MIC5376, 2.8V Output Voltage, -40°C to +125°C Temperature Range, 5-Lead SC-70, 3000/Reel
					b) MIC5376-2.8YMT-TZ: MIC5376, 2.8V Output Voltage, -40°C to +125°C Temperature Range, 4-Lead TDFN, 10000/Reel
					c) MIC5377YC5-TR: MIC5377, Adjustable Output Voltage, -40°C to +125°C Temperature Range, 5-Lead SC-70, 3000/Reel
					d) MIC5377YMT-TR: MIC5377, Adjustable Output Voltage, -40°C to +125°C Temperature Range, 8-Lead TQFN, 5000/Reel
					e) MIC5378YC5-TR: MIC5378, Adjustable Output Voltage, -40°C to +125°C Temperature Range, 5-Lead SC-70, 3000/Reel
					f) MIC5378YMT-TR: MIC5378, Adjustable Output Voltage, -40°C to +125°C Temperature Range, 8-Lead TQFN, 5000/Reel
					Note 1: Tape and Reel identifier only appears in the catalog part number description. This identifier is used for ordering purposes and is not printed on the device package. Check with your Microchip Sales Office for package availability with the Tape and Reel option.

MIC5376/7/8

NOTES:

Note the following details of the code protection feature on Microchip devices:

- Microchip products meet the specification contained in their particular Microchip Data Sheet.
- Microchip believes that its family of products is one of the most secure families of its kind on the market today, when used in the intended manner and under normal conditions.
- There are dishonest and possibly illegal methods used to breach the code protection feature. All of these methods, to our knowledge, require using the Microchip products in a manner outside the operating specifications contained in Microchip's Data Sheets. Most likely, the person doing so is engaged in theft of intellectual property.
- Microchip is willing to work with the customer who is concerned about the integrity of their code.
- Neither Microchip nor any other semiconductor manufacturer can guarantee the security of their code. Code protection does not mean that we are guaranteeing the product as “unbreakable.”

Code protection is constantly evolving. We at Microchip are committed to continuously improving the code protection features of our products. Attempts to break Microchip's code protection feature may be a violation of the Digital Millennium Copyright Act. If such acts allow unauthorized access to your software or other copyrighted work, you may have a right to sue for relief under that Act.

Information contained in this publication regarding device applications and the like is provided only for your convenience and may be superseded by updates. It is your responsibility to ensure that your application meets with your specifications. MICROCHIP MAKES NO REPRESENTATIONS OR WARRANTIES OF ANY KIND WHETHER EXPRESS OR IMPLIED, WRITTEN OR ORAL, STATUTORY OR OTHERWISE, RELATED TO THE INFORMATION, INCLUDING BUT NOT LIMITED TO ITS CONDITION, QUALITY, PERFORMANCE, MERCHANTABILITY OR FITNESS FOR PURPOSE. Microchip disclaims all liability arising from this information and its use. Use of Microchip devices in life support and/or safety applications is entirely at the buyer's risk, and the buyer agrees to defend, indemnify and hold harmless Microchip from any and all damages, claims, suits, or expenses resulting from such use. No licenses are conveyed, implicitly or otherwise, under any Microchip intellectual property rights unless otherwise stated.

Microchip received ISO/TS-16949:2009 certification for its worldwide headquarters, design and wafer fabrication facilities in Chandler and Tempe, Arizona; Gresham, Oregon and design centers in California and India. The Company's quality system processes and procedures are for its PIC® MCUs and dsPIC® DSCs, KEELoc® code hopping devices, Serial EEPROMs, microperipherals, nonvolatile memory and analog products. In addition, Microchip's quality system for the design and manufacture of development systems is ISO 9001:2000 certified.

**QUALITY MANAGEMENT SYSTEM
CERTIFIED BY DNV
= ISO/TS 16949 =**

Trademarks

The Microchip name and logo, the Microchip logo, AnyRate, AVR, AVR logo, AVR Freaks, BitCloud, chipKIT, chipKIT logo, CryptoMemory, CryptoRF, dsPIC, FlashFlex, flexPWR, Heldo, JukeBlox, KeeLoq, Kleer, LANCheck, LINK MD, maXStylus, maXTouch, MediaLB, megaAVR, MOST, MOST logo, MPLAB, OptoLyzer, PIC, picoPower, PICSTART, PIC32 logo, Prochip Designer, QTouch, SAM-BA, SpyNIC, SST, SST Logo, SuperFlash, tinyAVR, UNI/O, and XMEGA are registered trademarks of Microchip Technology Incorporated in the U.S.A. and other countries.

ClockWorks, The Embedded Control Solutions Company, EtherSynch, Hyper Speed Control, HyperLight Load, IntellIMOS, mTouch, Precision Edge, and Quiet-Wire are registered trademarks of Microchip Technology Incorporated in the U.S.A.

Adjacent Key Suppression, AKS, Analog-for-the-Digital Age, Any Capacitor, AnyIn, AnyOut, BodyCom, CodeGuard, CryptoAuthentication, CryptoAutomotive, CryptoCompanion, CryptoController, dsPICDEM, dsPICDEM.net, Dynamic Average Matching, DAM, ECAN, EtherGREEN, In-Circuit Serial Programming, ICSP, INICnet, Inter-Chip Connectivity, JitterBlocker, KleerNet, KleerNet logo, memBrain, Mindi, MiWi, motorBench, MPASM, MPF, MPLAB Certified logo, MPLIB, MPLINK, MultiTRAK, NetDetach, Omniscient Code Generation, PICDEM, PICDEM.net, PICKit, PICtail, PowerSmart, PureSilicon, QMatrix, REAL ICE, Ripple Blocker, SAM-ICE, Serial Quad I/O, SMART-I.S., SQI, SuperSwitcher, SuperSwitcher II, Total Endurance, TSHARC, USBCheck, VariSense, ViewSpan, WiperLock, Wireless DNA, and ZENA are trademarks of Microchip Technology Incorporated in the U.S.A. and other countries.

SQTP is a service mark of Microchip Technology Incorporated in the U.S.A.

Silicon Storage Technology is a registered trademark of Microchip Technology Inc. in other countries.

GestIC is a registered trademark of Microchip Technology Germany II GmbH & Co. KG, a subsidiary of Microchip Technology Inc., in other countries.

All other trademarks mentioned herein are property of their respective companies.

© 2018, Microchip Technology Incorporated, All Rights Reserved.
ISBN: 978-1-5224-3587-7



MICROCHIP

Worldwide Sales and Service

AMERICAS

Corporate Office
2355 West Chandler Blvd.
Chandler, AZ 85224-6199
Tel: 480-792-7200
Fax: 480-792-7277
Technical Support:
<http://www.microchip.com/support>
Web Address:
www.microchip.com

Atlanta

Duluth, GA
Tel: 678-957-9614
Fax: 678-957-1455

Austin, TX

Tel: 512-257-3370

Boston

Westborough, MA
Tel: 774-760-0087
Fax: 774-760-0088

Chicago

Itasca, IL
Tel: 630-285-0071
Fax: 630-285-0075

Dallas

Addison, TX
Tel: 972-818-7423
Fax: 972-818-2924

Detroit

Novi, MI
Tel: 248-848-4000

Houston, TX

Tel: 281-894-5983

Indianapolis

Noblesville, IN
Tel: 317-773-8323
Fax: 317-773-5453
Tel: 317-536-2380

Los Angeles

Mission Viejo, CA
Tel: 949-462-9523
Fax: 949-462-9608
Tel: 951-273-7800

Raleigh, NC

Tel: 919-844-7510

New York, NY

Tel: 631-435-6000

San Jose, CA

Tel: 408-735-9110
Tel: 408-436-4270

Canada - Toronto

Tel: 905-695-1980
Fax: 905-695-2078

ASIA/PACIFIC

Australia - Sydney
Tel: 61-2-9868-6733

China - Beijing
Tel: 86-10-8569-7000

China - Chengdu
Tel: 86-28-8665-5511

China - Chongqing
Tel: 86-23-8980-9588

China - Dongguan
Tel: 86-769-8702-9880

China - Guangzhou
Tel: 86-20-8755-8029

China - Hangzhou
Tel: 86-571-8792-8115

China - Hong Kong SAR
Tel: 852-2943-5100

China - Nanjing
Tel: 86-25-8473-2460

China - Qingdao
Tel: 86-532-8502-7355

China - Shanghai
Tel: 86-21-3326-8000

China - Shenyang
Tel: 86-24-2334-2829

China - Shenzhen
Tel: 86-755-8864-2200

China - Suzhou
Tel: 86-186-6233-1526

China - Wuhan
Tel: 86-27-5980-5300

China - Xian
Tel: 86-29-8833-7252

China - Xiamen
Tel: 86-592-2388138

China - Zhuhai
Tel: 86-756-3210040

ASIA/PACIFIC

India - Bangalore
Tel: 91-80-3090-4444

India - New Delhi
Tel: 91-11-4160-8631

India - Pune
Tel: 91-20-4121-0141

Japan - Osaka
Tel: 81-6-6152-7160

Japan - Tokyo
Tel: 81-3-6880-3770

Korea - Daegu
Tel: 82-53-744-4301

Korea - Seoul
Tel: 82-2-554-7200

Malaysia - Kuala Lumpur
Tel: 60-3-7651-7906

Malaysia - Penang
Tel: 60-4-227-8870

Philippines - Manila
Tel: 63-2-634-9065

Singapore
Tel: 65-6334-8870

Taiwan - Hsin Chu
Tel: 886-3-577-8366

Taiwan - Kaohsiung
Tel: 886-7-213-7830

Taiwan - Taipei
Tel: 886-2-2508-8600

Thailand - Bangkok
Tel: 66-2-694-1351

Vietnam - Ho Chi Minh
Tel: 84-28-5448-2100

EUROPE

Austria - Wels
Tel: 43-7242-2244-39
Fax: 43-7242-2244-393

Denmark - Copenhagen
Tel: 45-4450-2828
Fax: 45-4485-2829

Finland - Espoo
Tel: 358-9-4520-820

France - Paris
Tel: 33-1-69-53-63-20
Fax: 33-1-69-30-90-79

Germany - Garching
Tel: 49-8931-9700

Germany - Haan
Tel: 49-2129-3766400

Germany - Heilbronn
Tel: 49-7131-67-3636

Germany - Karlsruhe
Tel: 49-721-625370

Germany - Munich
Tel: 49-89-627-144-0
Fax: 49-89-627-144-44

Germany - Rosenheim
Tel: 49-8031-354-560

Israel - Ra'anana
Tel: 972-9-744-7705

Italy - Milan
Tel: 39-0331-742611
Fax: 39-0331-466781

Italy - Padova
Tel: 39-049-7625286

Netherlands - Drunen
Tel: 31-416-690399
Fax: 31-416-690340

Norway - Trondheim
Tel: 47-7288-4388

Poland - Warsaw
Tel: 48-22-3325737

Romania - Bucharest
Tel: 40-21-407-87-50

Spain - Madrid
Tel: 34-91-708-08-90
Fax: 34-91-708-08-91

Sweden - Gothenberg
Tel: 46-31-704-60-40

Sweden - Stockholm
Tel: 46-8-5090-4654

UK - Wokingham
Tel: 44-118-921-5800
Fax: 44-118-921-5820

Looking for pricing, stock, or lifecycle information?

Click below to explore more details on WIN SOURCE:

 [View MIC5378YC5-TR on WIN SOURCE](#)

 [Microchip Technology](#) Information

Optimize Your Supply Chain with WIN SOURCE Solutions

-  Global Sourcing Solution
-  Obsolete Management
-  Cost Control Management
-  Shortage Management
-  Alternative Solution
-  Excess Inventory Management