Single Supply V_{IN} , LOW V_{IN} , LOW V_{OUT} , 1A LDO

Features

- Single Input Voltage Range: V_{IN} 1.65V to 5.5V
- Maximum Dropout ($V_{IN} - V_{OUT}$) of 500 mV over Temperature
- Adjustable Output Voltage Down to 0.5V
- Stable with 4.7 μ F Ceramic Output Capacitor
- Excellent Line and Load Regulation Specifications
- Logic-Controlled Shutdown
- Thermal Shutdown and Current-Limit Protection
- 10-Pin 3 mm x 3 mm DFN Package
- -40°C to $+125^{\circ}\text{C}$ Junction Temperature Range

Applications

- Point-of-Load Applications
- Industrial Power
- Sensitive RF Applications

General Description

The MIC69101/103 are the 1A output current member of the MIC69xxx family of high current, low voltage regulators, that support currents of 1A, 1.5A, 3A, and 5A. The MIC69101/103 operates from a single low voltage supply, yet offers high precision and ultra-low dropout of 500 mV under worst case conditions.

The MIC69101/103 operate from an input voltage of 1.65V to 5.5V. It is designed to drive digital circuits requiring low voltage at high currents (i.e. PLDs, DSP, microcontroller, etc.). These regulators are available in adjustable and fixed output voltages including 1.8V. The adjustable version can support output voltages down to 0.5V.

The μ Cap design of the MIC69101/103 is optimized for stability with low value low-ESR ceramic output capacitors.

Features of the MIC69101/103 include thermal shutdown and current limit protection. Logic enable and error flag pins are also available.

The MIC69101/103 are offered in a tiny 10-pin 3 mm x 3 mm DFN package and has an operating temperature range of -40°C to $+125^{\circ}\text{C}$.

Package Type

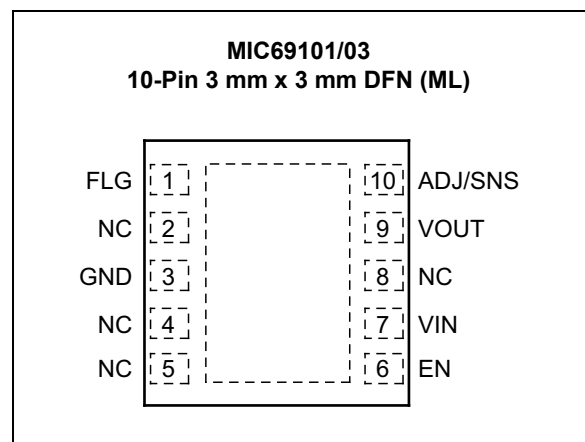

MIC69101/103

Typical Application Circuits

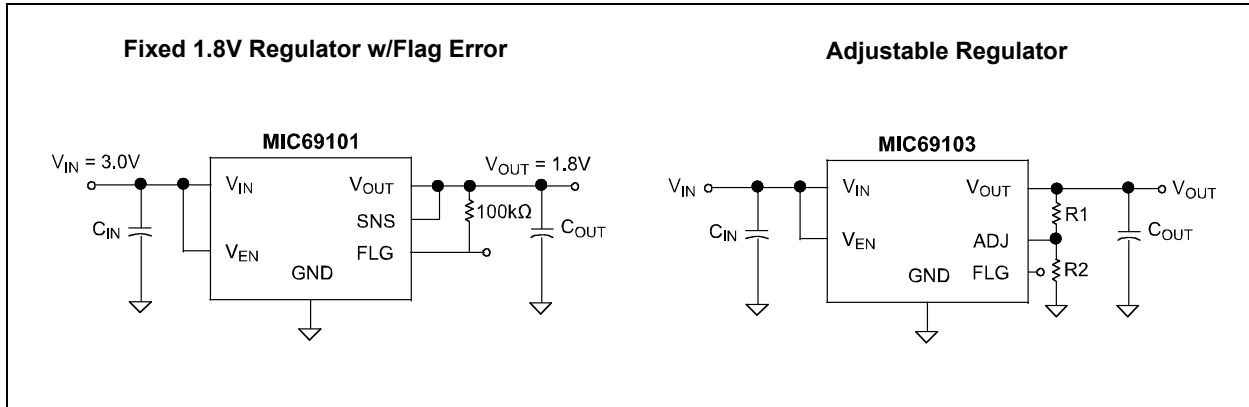

Functional Block Diagram

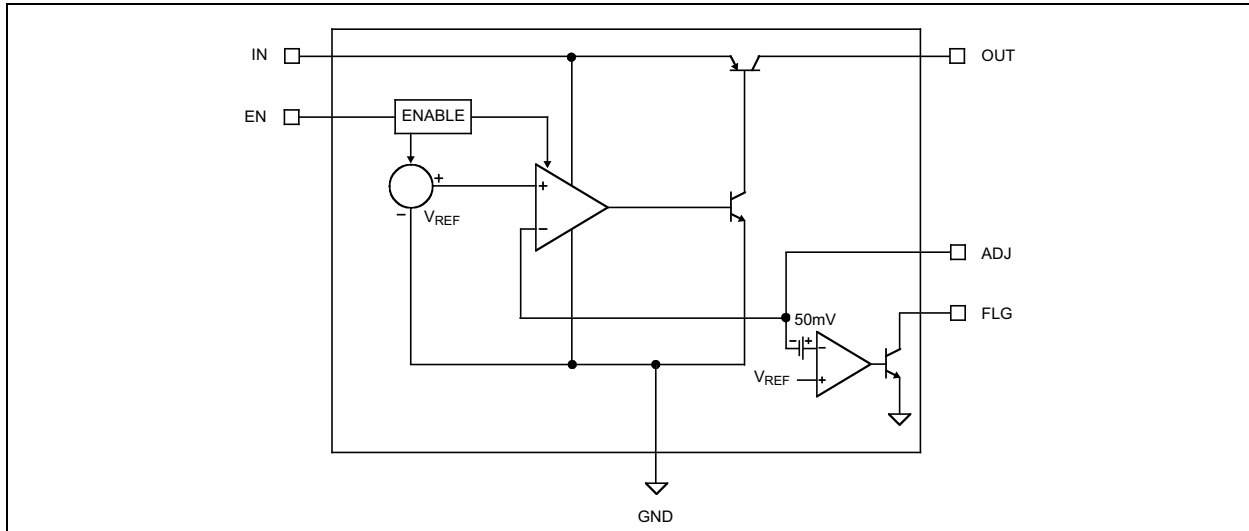

1.0 ELECTRICAL CHARACTERISTICS

Absolute Maximum Ratings †

Supply Input Voltage (V_{IN})	+6V
Logic Input Voltage (V_{EN})	0V to V_{IN}
Power Dissipation (P_D) (Note 1)	Internally Limited
Flag Pin (FLG)	+6V
ESD Rating (Note 1)	2 kV

Operating Ratings ‡

Supply Voltage (V_{IN})	+1.65V to +5.5V
Enable Input Voltage (V_{EN})	0V to V_{IN}

† **Notice:** Stresses above those listed under “Absolute Maximum Ratings” may cause permanent damage to the device. This is a stress rating only and functional operation of the device at those or any other conditions above those indicated in the operational sections of this specification is not intended. Exposure to maximum rating conditions for extended periods may affect device reliability. Specifications are for packaged product only.

‡ **Notice:** The device is not guaranteed to function outside its operating ratings.

Note 1: The maximum allowable power dissipation of any T_A (ambient temperature) is $P_{D(max)} = (T_{J(max)} - T_A) / \theta_{JA}$. Exceeding the maximum allowable power dissipation will result in excessive die temperature and the regulator will go into thermal shutdown.

2: Devices are ESD sensitive. Handling precautions are recommended. Human body model, 1.5 k Ω in series with 100 pF

TABLE 1-1: ELECTRICAL CHARACTERISTICS

Electrical Characteristics: $T_A = 25^\circ\text{C}$ with $V_{IN} = V_{OUT} + 0.5\text{V}$; **Bold** values indicate $-40^\circ\text{C} \leq T_J \leq +125^\circ\text{C}$; $I_{OUT} = 10\text{ mA}$; $C_{OUT} = 4.7\ \mu\text{F}$ ceramic, unless otherwise noted.

Parameter	Symbol	Min.	Typ.	Max.	Units	Conditions
Output Voltage Accuracy (Fixed)	V_{OUT}	-2	—	+2	%	Over temperature range
Output Voltage Accuracy (Adj)		0.49	0.5	0.51	V	—
Feedback Pin Current	I_{FB}	—	0.21	1	μA	—
Output Voltage Line Regulation (Note 1)	$\Delta V_{OUT}/\Delta V_{IN}$	—	± 0.1	± 0.3	%/V	$V_{IN} = V_{OUT} + 1.0\text{V}$ to 5.5V For $V_{OUT} \geq 0.65\text{V}$, $V_{IN} = 1.65$ to 5.5V
Output Voltage Load Regulation	$\Delta V_{OUT}/V_{OUT}$	—	± 0.25	—	%	$I_L = 10\text{ mA}$ to 1A
$V_{IN} - V_{OUT}$; Dropout Voltage (Note 2)	V_{DO}	—	150	300	mV	$I_L = 0.5\text{A}$
		—	215	500	mV	$I_L = 1.0\text{A}$
Ground Pin Current	I_{GND}	—	1.1	—	mA	$I_L = 10\text{ mA}$
		—	4.7	—	mA	$I_L = 0.5\text{A}$
		—	11	20	mA	$I_L = 1.0\text{A}$
Ground Pin Current in Shutdown	I_{SHDN}	—	1	—	μA	$V_{EN} = 0\text{V}$
Current Limit	I_{LIM}	1.2	1.95	—	A	$V_{OUT} = 0\text{V}$
Start-up Time	t_{START}	—	10	150	μs	$V_{EN} = V_{IN}$
Thermal Shutdown	T_{HSHDN}	—	165	—	$^\circ\text{C}$	—
Enable Input						
Enable Input Threshold	V_{EN}	0.8	0.6	—	V	Regulator enable
		—	—	0.2	V	Regulator shutdown
Enable Pin Input Current	I_{EN}	—	0.005	—	μA	$V_{IL} \leq 0.2\text{V}$ (Regulator shutdown)
		—	7	—	μA	$V_{IH} \geq 0.8\text{V}$ (Regulator enable)

MIC69101/103

Electrical Characteristics: $T_A = 25^\circ\text{C}$ with $V_{IN} = V_{OUT} + 0.5\text{V}$; **Bold** values indicate $-40^\circ\text{C} \leq T_J \leq +125^\circ\text{C}$; $I_{OUT} = 10\text{ mA}$; $C_{OUT} = 4.7\ \mu\text{F}$ ceramic, unless otherwise noted.

Parameter	Symbol	Min.	Typ.	Max.	Units	Conditions
Flag Output						
Flag Output Leakage Current	$I_{FLG(LEAK)}$	—	0.05	—	μA	Flag off
Output Logic-Low Voltage (Undervoltage condition)	$V_{FLG(LO)}$	—	150	—	mV	$I_L = 5\text{ mA}$
Flag Threshold	V_{FLG}	7.5	10	14	%	% of V_{OUT} below nominal (falling)
Hysteresis	—	—	2	—	%	—

- 1: Minimum input for line regulation test is set to $V_{OUT} + 1\text{V}$ relative to the highest output voltage.
- 2: Dropout voltage is defined as the input-to-output differential at which the output voltage drops 2% below its nominal value measured at 1V differential. For outputs below 1.65V, dropout voltage is considered the input-to-output voltage differential with the minimum input voltage of 1.65V. Minimum input operating voltage is 1.65V.

TEMPERATURE SPECIFICATIONS (Note 1)

Parameters	Sym.	Min.	Typ.	Max.	Units	Conditions
Temperature Ranges						
Storage Temperature Range	T_S	-65	—	+125	°C	—
Junction Temperature Range	T_J	-40	—	+125	°C	—
Package Thermal Resistances						
Thermal Resistance (3 mm x 3 mm DFN-10)	θ_{JA}	—	60	—	°C/W	—

Note 1: The maximum allowable power dissipation is a function of ambient temperature, the maximum allowable junction temperature and the thermal resistance from junction to air (i.e., T_A , T_J , θ_{JA}). Exceeding the maximum allowable power dissipation will cause the device operating junction temperature to exceed the maximum +125°C rating. Sustained junction temperatures above +125°C can impact the device reliability.

MIC69101/103

2.0 TYPICAL PERFORMANCE CURVES

Note: The graphs and tables provided following this note are a statistical summary based on a limited number of samples and are provided for informational purposes only. The performance characteristics listed herein are not tested or guaranteed. In some graphs or tables, the data presented may be outside the specified operating range (e.g., outside specified power supply range) and therefore outside the warranted range.

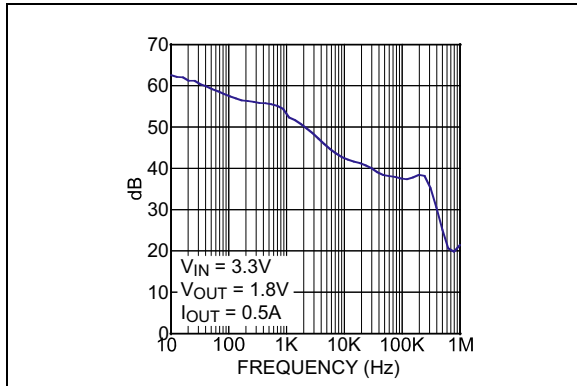

FIGURE 2-1: Power Supply Rejection Ratio.

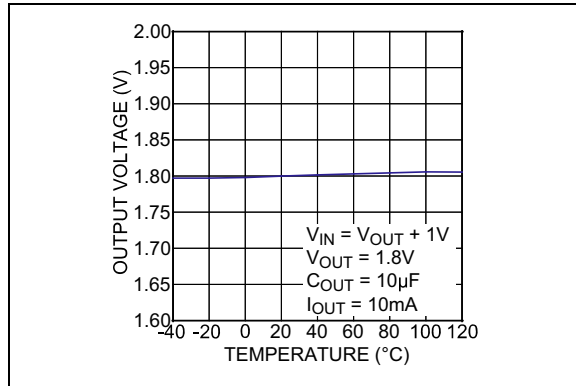

FIGURE 2-4: Output Voltage vs. Temperature.

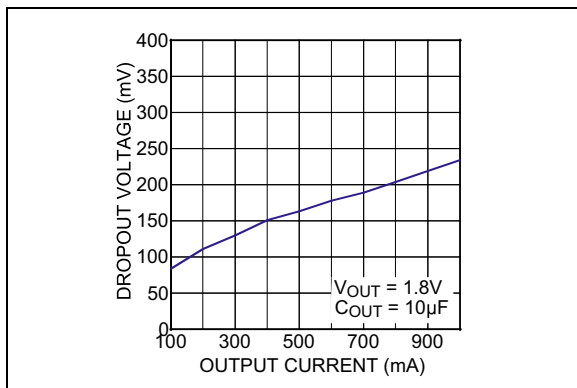

FIGURE 2-2: Dropout Voltage vs. Output Current.

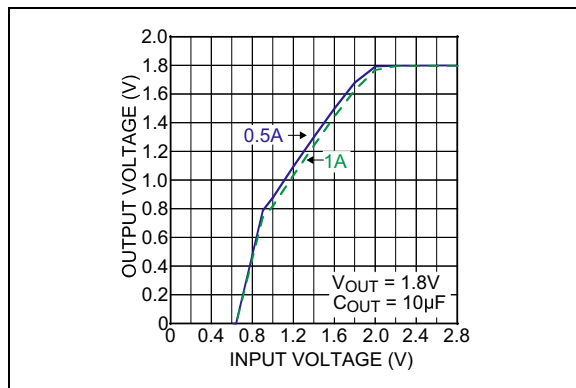

FIGURE 2-5: Output Voltage vs. Input Voltage.

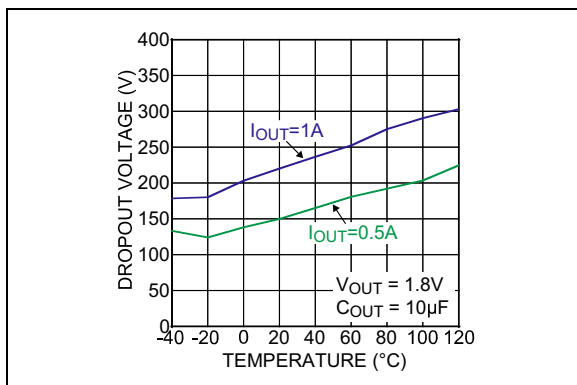

FIGURE 2-3: Dropout Voltage vs. Temperature.

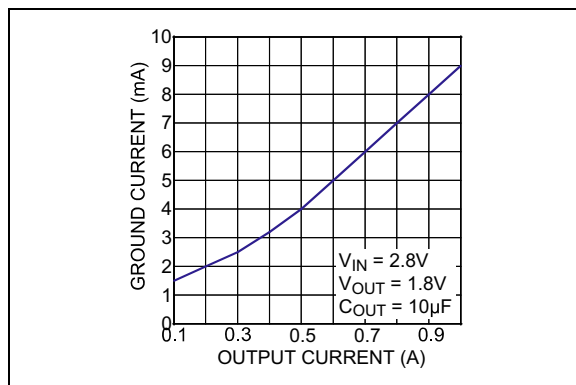

FIGURE 2-6: Ground Current vs. Output Current.

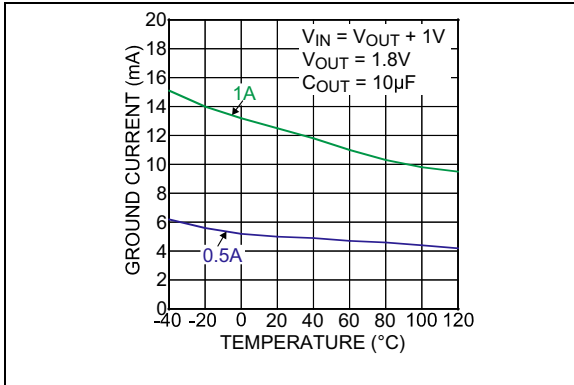

FIGURE 2-7: Ground Current vs. Temperature.

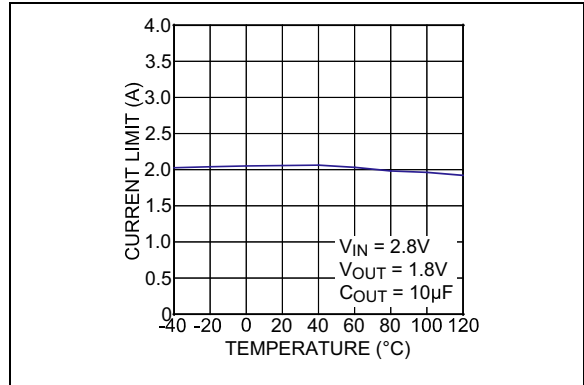

FIGURE 2-10: Current-Limit vs. Temperature.

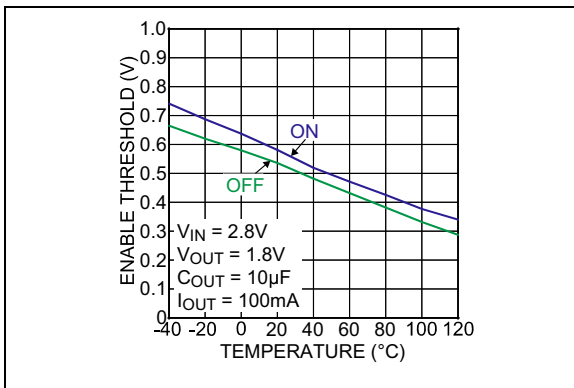

FIGURE 2-8: Enable Threshold vs. Temperature.

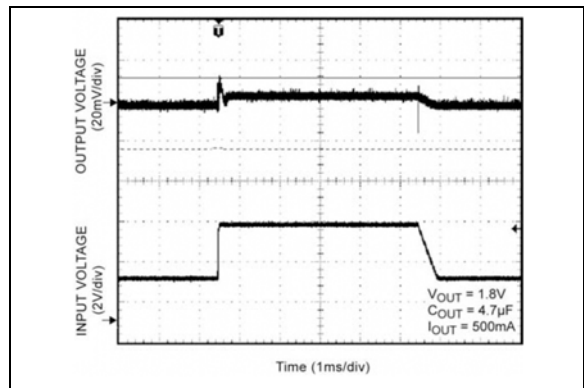

FIGURE 2-11: Line Transient.

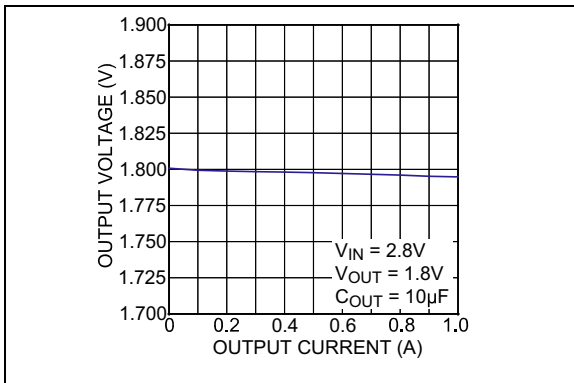

FIGURE 2-9: Load Regulation.

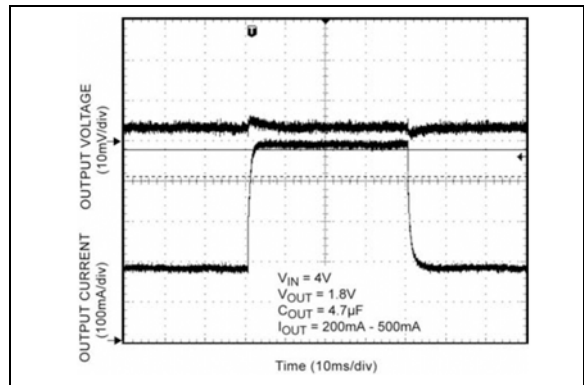

FIGURE 2-12: Load Transient.

MIC69101/103

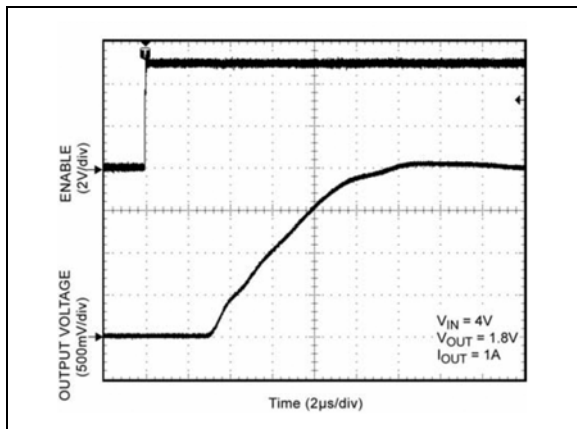

FIGURE 2-13: *Enable Turn-On.*

3.0 PIN DESCRIPTIONS

The descriptions of the pins are listed in [Table 3-1](#).

TABLE 3-1: PIN FUNCTION TABLE

Pin Number	Pin Name	Description
1	FLG	Error Flag (Output): Open collector output. Active low indicates an output fault condition.
2, 4, 5, 8	NC	Not internally connected.
3 (EP)	GND	Ground (exposed pad is recommended to connect to ground on DFN).
6	EN	Enable (Input): CMOS compatible input. Logic high = enable, logic low = shutdown. Do not leave pin floating.
7	VIN	Input voltage that supplies current to the output power device.
9	VOUT	Regulator Output.
10 (ADJ)	ADJ	Adjustable regulator feedback input. Connect to resistor voltage divider.
10 (FIXED)	SNS	Sense pin, connect to output for improved voltage regulation.

MIC69101/103

4.0 APPLICATION INFORMATION

The MIC69101/103 are ultra-high performance low dropout linear regulators designed for high current applications requiring a fast transient response. They utilize a single input supply, perfect for low-voltage DC-to-DC conversion. The MIC69101/103 require a minimum number of external components. The MIC69101/103 regulators are fully protected from damage due to fault conditions offering constant current limiting and thermal shutdown.

4.1 Input Supply Voltage

V_{IN} provides a high current to the collector of the pass transistor. The minimum input voltage is 1.65V allowing conversion from low voltage supplies.

4.2 Input Capacitor

An input capacitor of 1 μ F or greater is recommended when the device is more than 4 inches away from the bulk AC supply capacitance or when the supply is a battery. Small, surface mount, ceramic chip capacitors can be used for bypassing. The capacitor should be placed within 1 inch of the device for optimal performance. Larger values will help to improve ripple rejection by bypassing the input to the regulator, further improving the integrity of the output voltage.

4.3 Output Capacitor

The MIC69101/103 require a minimum of output capacitance to maintain stability. However, proper capacitor selection is important to ensure desired transient response. The MIC69101/103 are specifically designed to be stable with low ESR ceramic chip capacitors. A 4.7 μ F ceramic chip capacitor should satisfy most applications. Output capacitor can be increased without bound. See typical characteristics for examples of load transient response.

X7R dielectric ceramic capacitors are recommended because of their temperature performance. X7R-type capacitors change capacitance by only 15% over their operating temperature range and are the most stable type of ceramic capacitors. Z5U and Y5V dielectric capacitors change value by as much as 50% and 60%, respectively over their operating temperature ranges. To use a ceramic chip capacitor with Y5V dielectric the value must be much higher than an X7R ceramic or a tantalum capacitor to ensure the same capacitance value over the operating temperature range. Tantalum capacitors have a very stable dielectric (10% over their operating temperature range) and can also be used with this device.

4.4 Minimum Load Current

The MIC69101/103 regulator is specified between finite loads. If the output current is too small, leakage currents dominate and the output voltage rises. A 10 mA minimum load current is necessary for proper operation.

4.5 Adjustable Regulator Design

The MIC69103 adjustable version allows programming the output voltage anywhere between 0.5V and 5.5V with two resistors. The resistor value between V_{OUT} and the adjust pin should not exceed 10 k Ω . Larger values can cause instability. The resistor values are calculated by:

EQUATION 4-1:

$$V_{OUT} = 0.5 \left(\frac{R1}{R2} + 1 \right)$$

Where:

V_{OUT} is the desired output Voltage

4.6 Enable

The MIC69101 fixed output voltage version features an active high enable input (EN) that allows on-off control of the regulator. Current drain reduces to near “zero” when the device is shutdown, with only microamperes of leakage current. EN may be directly tied to V_{IN} and pulled up to the maximum supply voltage.

4.7 Thermal Design

Linear regulators are simple to use. The most complicated design parameters to consider are thermal characteristics. Thermal design requires the following application-specific parameters:

- Maximum ambient temperature (T_A)
- Output current (I_{OUT})
- Output voltage (V_{OUT})
- Input voltage (V_{IN})
- Ground current (I_{GND})

First, calculate the power dissipation of the regulator from these numbers and the device parameters from this data sheet.

EQUATION 4-2:

$$P_D = (V_{IN} - V_{OUT})I_{OUT} + V_{IN} \times I_{GND}$$

In [Equation 4-2](#), the ground current is approximated by using numbers from the **Section 1.0 “Electrical Characteristics”** or **Section 2.0 “Typical Performance Curves”** sections. The maximum allowable power dissipation of any T_A (ambient temperature) is $P_{D(MAX)} = (T_{J(MAX)} - T_A) / \theta_{JA}$. Exceeding the maximum allowable power dissipation will result in excessive die temperature and the regulator will go into thermal shutdown.

Refer to [Application Note 9](#) for further details and examples on thermal design and heat sink applications.

MIC69101/103

5.0 PACKAGING INFORMATION

5.1 Package Marking Information

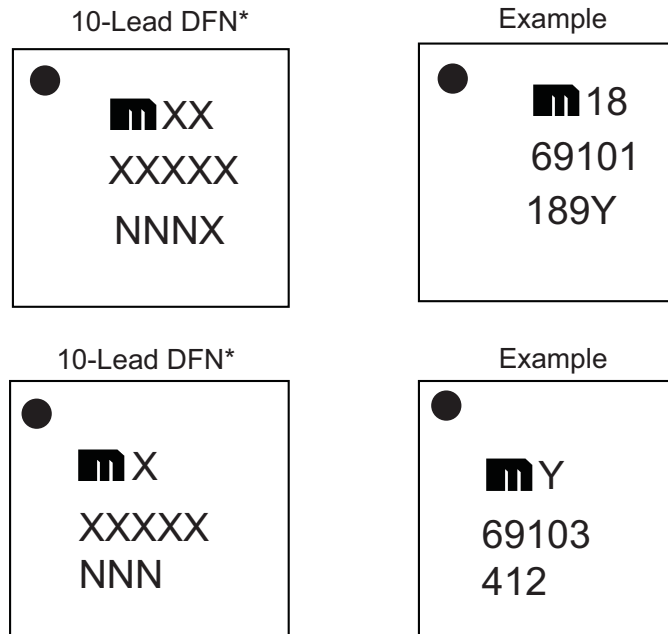

Legend: XX...X Product code or customer-specific information
Y Year code (last digit of calendar year)
YY Year code (last 2 digits of calendar year)
WW Week code (week of January 1 is week '01')
NNN Alphanumeric traceability code
ⓔ3 Pb-free JEDEC® designator for Matte Tin (Sn)
* This package is Pb-free. The Pb-free JEDEC designator (ⓔ3) can be found on the outer packaging for this package.

●, ▲, ▼ Pin one index is identified by a dot, delta up, or delta down (triangle mark).

Note: In the event the full Microchip part number cannot be marked on one line, it will be carried over to the next line, thus limiting the number of available characters for customer-specific information. Package may or may not include the corporate logo.

Underbar () and/or Overbar () symbol may not be to scale.

10-Lead 3 mm x 3 mm DFN Package Outline and Recommended Land Pattern

TITLE

10 LEAD DFN 3x3mm PACKAGE OUTLINE & RECOMMENDED LAND PATTERN

DRAWING #	DFN33-10LD-PL-1	UNIT	MM
------------------	-----------------	-------------	----

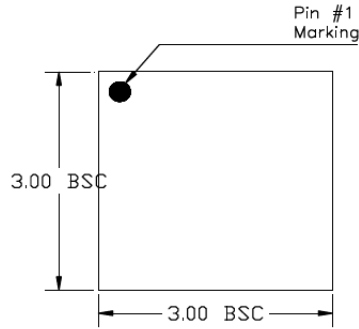

TOP VIEW
NOTE: 1, 2, 3

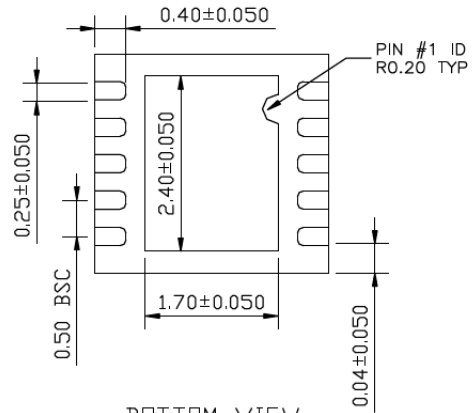

BOTTOM VIEW
NOTE: 1, 2, 3

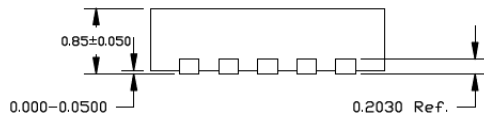

SIDE VIEW
NOTE: 1, 2, 3

NOTE:

1. MAX PACKAGE WARPAGE IS 0.05 MM
2. MAX ALLOWABLE BURR IS 0.076MM IN ALL DIRECTIONS
3. PIN #1 IS ON TOP WILL BE LASER MARKED
4. RED CIRCLE IN LAND PATTERN INDICATE THERMAL VIA. SIZE SHOULD BE 0.30-0.35 MM IN DIAMETER AND SHOULD BE CONNECTED TO GND FOR MAX THERMAL PERFORMANCE
5. GREEN RECTANGLES (SHADED AREA) INDICATE SOLDER STENCIL OPENING ON EXPOSED PAD AREA. SIZE SHOULD BE 0.50x0.95 MM IN SIZE, 0.20 MM SPACING.

Note: For the most current package drawings, please see the Microchip Packaging Specification located at <http://www.microchip.com/packaging>.

MIC69101/103

10-Lead 3 mm x 3 mm DFN Package Outline and Recommended Land Pattern

POD-Land Pattern drawing #DFN33-10LD-PL-1

RECOMMENDED LAND PATTERN

NOTE: 4, 5

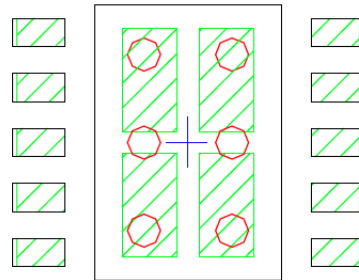

STACKED-UP

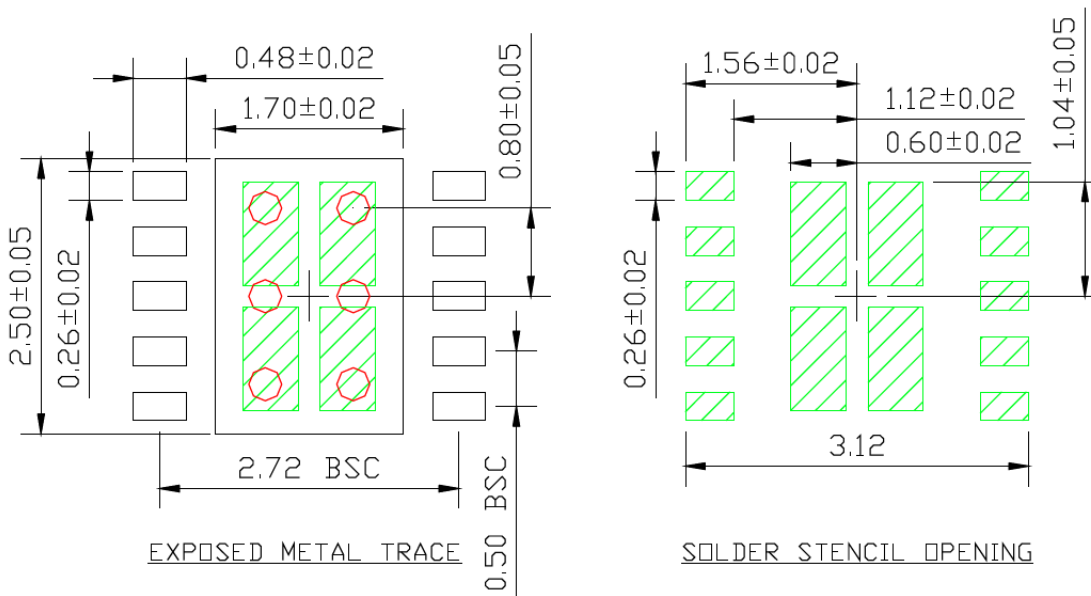

Note: For the most current package drawings, please see the Microchip Packaging Specification located at <http://www.microchip.com/packaging>.

APPENDIX A: REVISION HISTORY

Revision A (May 2018)

- Converted Micrel document MIC69101/103 to Microchip data sheet DS20006018A.
- Minor text changes throughout.

MIC69101/103

NOTES:

PRODUCT IDENTIFICATION SYSTEM

To order or obtain information, e.g., on pricing or delivery, contact your local Microchip representative or sales office.

<u>PART NO.</u>	<u>-X.X</u>	<u>X</u>	<u>XX</u>	<u>-XX</u>
Device	Output Voltage	Junction Temperature Range	Package	Media Type
Device:	MIC6910x: Single Supply V_{IN} , LOW V_{IN} , LOW V_{OUT} , 1A LDO			
	MIC69101: Fixed Output Voltage			
	MIC69103: Adjustable Output Voltage Down to 0.5V			
Output Voltage:	1.8 = 1.8V Fixed <blank> = Adjustable			
Junction Temperature Range:	Y = -40°C to +125°C, Industrial, RoHS Compliant			
Package:	ML = 10-Lead DFN (3 mm x 3 mm x 0.9 mm)			
Media Type:	TR = 5000/Reel			

Examples:

- a) MIC69101-1.8YML-TR: Single Supply V_{IN} , LOW V_{IN} , LOW V_{OUT} , 1A LDO, 1.8 Fixed Output Voltage, -40°C to +125°C Junction Temperature Range, 10-Lead DFN Package, 5000/Reel
- b) MIC69103YML-TR: Single Supply V_{IN} , LOW V_{IN} , LOW V_{OUT} , 1A LDO, Adjustable Output Voltage, -40°C to +125°C Junction Temperature Range, 10-Lead DFN Package, 5000/Reel

Note 1: Tape and Reel identifier only appears in the catalog part number description. This identifier is used for ordering purposes and is not printed on the device package. Check with your Microchip Sales Office for package availability with the Tape and Reel option.

MIC69101/103

NOTES:

Note the following details of the code protection feature on Microchip devices:

- Microchip products meet the specification contained in their particular Microchip Data Sheet.
- Microchip believes that its family of products is one of the most secure families of its kind on the market today, when used in the intended manner and under normal conditions.
- There are dishonest and possibly illegal methods used to breach the code protection feature. All of these methods, to our knowledge, require using the Microchip products in a manner outside the operating specifications contained in Microchip's Data Sheets. Most likely, the person doing so is engaged in theft of intellectual property.
- Microchip is willing to work with the customer who is concerned about the integrity of their code.
- Neither Microchip nor any other semiconductor manufacturer can guarantee the security of their code. Code protection does not mean that we are guaranteeing the product as “unbreakable.”

Code protection is constantly evolving. We at Microchip are committed to continuously improving the code protection features of our products. Attempts to break Microchip's code protection feature may be a violation of the Digital Millennium Copyright Act. If such acts allow unauthorized access to your software or other copyrighted work, you may have a right to sue for relief under that Act.

Information contained in this publication regarding device applications and the like is provided only for your convenience and may be superseded by updates. It is your responsibility to ensure that your application meets with your specifications. MICROCHIP MAKES NO REPRESENTATIONS OR WARRANTIES OF ANY KIND WHETHER EXPRESS OR IMPLIED, WRITTEN OR ORAL, STATUTORY OR OTHERWISE, RELATED TO THE INFORMATION, INCLUDING BUT NOT LIMITED TO ITS CONDITION, QUALITY, PERFORMANCE, MERCHANTABILITY OR FITNESS FOR PURPOSE. Microchip disclaims all liability arising from this information and its use. Use of Microchip devices in life support and/or safety applications is entirely at the buyer's risk, and the buyer agrees to defend, indemnify and hold harmless Microchip from any and all damages, claims, suits, or expenses resulting from such use. No licenses are conveyed, implicitly or otherwise, under any Microchip intellectual property rights unless otherwise stated.

Microchip received ISO/TS-16949:2009 certification for its worldwide headquarters, design and wafer fabrication facilities in Chandler and Tempe, Arizona; Gresham, Oregon and design centers in California and India. The Company's quality system processes and procedures are for its PIC® MCUs and dsPIC® DSCs, KEELoQ® code hopping devices, Serial EEPROMs, microperipherals, nonvolatile memory and analog products. In addition, Microchip's quality system for the design and manufacture of development systems is ISO 9001:2000 certified.

**QUALITY MANAGEMENT SYSTEM
CERTIFIED BY DNV
= ISO/TS 16949 =**

Trademarks

The Microchip name and logo, the Microchip logo, AnyRate, AVR, AVR logo, AVR Freaks, BeaconThings, BitCloud, CryptoMemory, CryptoRF, dsPIC, FlashFlex, flexPWR, Heldo, JukeBlox, KEELoQ, KEELoQ logo, Klear, LANCheck, LINK MD, maXStylus, maXTouch, MediaLB, megaAVR, MOST, MOST logo, MPLAB, OptoLyzer, PIC, picoPower, PICSTART, PIC32 logo, Prochip Designer, QTouch, RightTouch, SAM-BA, SpyNIC, SST, SST Logo, SuperFlash, tinyAVR, UNI/O, and XMEGA are registered trademarks of Microchip Technology Incorporated in the U.S.A. and other countries.

ClockWorks, The Embedded Control Solutions Company, EtherSynch, Hyper Speed Control, HyperLight Load, IntelliMOS, mTouch, Precision Edge, and Quiet-Wire are registered trademarks of Microchip Technology Incorporated in the U.S.A.

Adjacent Key Suppression, AKS, Analog-for-the-Digital Age, Any Capacitor, AnyIn, AnyOut, BodyCom, chipKIT, chipKIT logo, CodeGuard, CryptoAuthentication, CryptoCompanion, CryptoController, dsPICDEM, dsPICDEM.net, Dynamic Average Matching, DAM, ECAN, EtherGREEN, In-Circuit Serial Programming, ICSP, Inter-Chip Connectivity, JitterBlocker, KlearNet, KlearNet logo, Mindi, MiWi, motorBench, MPASM, MPF, MPLAB Certified logo, MPLIB, MPLINK, MultiTRAK, NetDetach, Omniscient Code Generation, PICDEM, PICDEM.net, PICKit, PICTail, PureSilicon, QMatrix, RightTouch logo, REAL ICE, Ripple Blocker, SAM-ICE, Serial Quad I/O, SMART-I.S., SQI, SuperSwitcher, SuperSwitcher II, Total Endurance, TSHARC, USBCheck, VariSense, ViewSpan, WiperLock, Wireless DNA, and ZENA are trademarks of Microchip Technology Incorporated in the U.S.A. and other countries.

SQTP is a service mark of Microchip Technology Incorporated in the U.S.A.

Silicon Storage Technology is a registered trademark of Microchip Technology Inc. in other countries.

GestIC is a registered trademark of Microchip Technology Germany II GmbH & Co. KG, a subsidiary of Microchip Technology Inc., in other countries.

All other trademarks mentioned herein are property of their respective companies.

© 2018, Microchip Technology Incorporated, All Rights Reserved.
ISBN: 978-1-5224-3000-1



MICROCHIP

Worldwide Sales and Service

AMERICAS

Corporate Office
2355 West Chandler Blvd.
Chandler, AZ 85224-6199
Tel: 480-792-7200
Fax: 480-792-7277
Technical Support:
<http://www.microchip.com/support>
Web Address:
www.microchip.com

Atlanta

Duluth, GA
Tel: 678-957-9614
Fax: 678-957-1455

Austin, TX

Tel: 512-257-3370

Boston

Westborough, MA
Tel: 774-760-0087
Fax: 774-760-0088

Chicago

Itasca, IL
Tel: 630-285-0071
Fax: 630-285-0075

Dallas

Addison, TX
Tel: 972-818-7423
Fax: 972-818-2924

Detroit

Novi, MI
Tel: 248-848-4000

Houston, TX

Tel: 281-894-5983

Indianapolis

Noblesville, IN
Tel: 317-773-8323
Fax: 317-773-5453
Tel: 317-536-2380

Los Angeles

Mission Viejo, CA
Tel: 949-462-9523
Fax: 949-462-9608
Tel: 951-273-7800

Raleigh, NC

Tel: 919-844-7510

New York, NY

Tel: 631-435-6000

San Jose, CA

Tel: 408-735-9110
Tel: 408-436-4270

Canada - Toronto

Tel: 905-695-1980
Fax: 905-695-2078

ASIA/PACIFIC

Australia - Sydney
Tel: 61-2-9868-6733

China - Beijing
Tel: 86-10-8569-7000

China - Chengdu
Tel: 86-28-8665-5511

China - Chongqing
Tel: 86-23-8980-9588

China - Dongguan
Tel: 86-769-8702-9880

China - Guangzhou
Tel: 86-20-8755-8029

China - Hangzhou
Tel: 86-571-8792-8115

China - Hong Kong SAR
Tel: 852-2943-5100

China - Nanjing
Tel: 86-25-8473-2460

China - Qingdao
Tel: 86-532-8502-7355

China - Shanghai
Tel: 86-21-3326-8000

China - Shenyang
Tel: 86-24-2334-2829

China - Shenzhen
Tel: 86-755-8864-2200

China - Suzhou
Tel: 86-186-6233-1526

China - Wuhan
Tel: 86-27-5980-5300

China - Xian
Tel: 86-29-8833-7252

China - Xiamen
Tel: 86-592-2388138

China - Zhuhai
Tel: 86-756-3210040

ASIA/PACIFIC

India - Bangalore
Tel: 91-80-3090-4444

India - New Delhi
Tel: 91-11-4160-8631

India - Pune
Tel: 91-20-4121-0141

Japan - Osaka
Tel: 81-6-6152-7160

Japan - Tokyo
Tel: 81-3-6880-3770

Korea - Daegu
Tel: 82-53-744-4301

Korea - Seoul
Tel: 82-2-554-7200

Malaysia - Kuala Lumpur
Tel: 60-3-7651-7906

Malaysia - Penang
Tel: 60-4-227-8870

Philippines - Manila
Tel: 63-2-634-9065

Singapore
Tel: 65-6334-8870

Taiwan - Hsin Chu
Tel: 886-3-577-8366

Taiwan - Kaohsiung
Tel: 886-7-213-7830

Taiwan - Taipei
Tel: 886-2-2508-8600

Thailand - Bangkok
Tel: 66-2-694-1351

Vietnam - Ho Chi Minh
Tel: 84-28-5448-2100

EUROPE

Austria - Wels
Tel: 43-7242-2244-39
Fax: 43-7242-2244-393

Denmark - Copenhagen
Tel: 45-4450-2828
Fax: 45-4485-2829

Finland - Espoo
Tel: 358-9-4520-820

France - Paris
Tel: 33-1-69-53-63-20
Fax: 33-1-69-30-90-79

Germany - Garching
Tel: 49-8931-9700

Germany - Haan
Tel: 49-2129-3766400

Germany - Heilbronn
Tel: 49-7131-67-3636

Germany - Karlsruhe
Tel: 49-721-625370

Germany - Munich
Tel: 49-89-627-144-0
Fax: 49-89-627-144-44

Germany - Rosenheim
Tel: 49-8031-354-560

Israel - Ra'anana
Tel: 972-9-744-7705

Italy - Milan
Tel: 39-0331-742611
Fax: 39-0331-466781

Italy - Padova
Tel: 39-049-7625286

Netherlands - Drunen
Tel: 31-416-690399
Fax: 31-416-690340

Norway - Trondheim
Tel: 47-7289-7561

Poland - Warsaw
Tel: 48-22-3325737

Romania - Bucharest
Tel: 40-21-407-87-50

Spain - Madrid
Tel: 34-91-708-08-90
Fax: 34-91-708-08-91

Sweden - Gothenberg
Tel: 46-31-704-60-40

Sweden - Stockholm
Tel: 46-8-5090-4654

UK - Wokingham
Tel: 44-118-921-5800
Fax: 44-118-921-5820

Looking for pricing, stock, or lifecycle information?

Click below to explore more details on WIN SOURCE:

- ⊖ [View MIC69103YML-TR on WIN SOURCE](#)
- ⊖ [Microchip Technology](#) Information

Optimize Your Supply Chain with WIN SOURCE Solutions

- ✓ Global Sourcing Solution
- ✓ Obsolete Management
- ✓ Cost Control Management
- ✓ Shortage Management
- ✓ Alternative Solution
- ✓ Excess Inventory Management