



## Single Supply $V_{IN}$ , LOW $V_{IN}$ , LOW $V_{OUT}$ , 1.5A LDO

### Features

- Single Input Voltage Range:  $V_{IN}$  1.65V to 5.5V
- Maximum Dropout ( $V_{IN} - V_{OUT}$ ) of 500 mV over Temperature
- Adjustable Output Voltage Down to 0.5V
- Stable with 10  $\mu$ F Ceramic Output Capacitor
- Excellent Line and Load Regulation Specifications
- Logic-Controlled Shutdown
- Thermal Shutdown and Current-Limit Protection
- 10-Pin 3 mm x 3 mm DFN Package
- ePAD SOIC-8 package
- $-40^{\circ}\text{C}$  to  $+125^{\circ}\text{C}$  Junction Temperature Range

### Applications

- Point-of-Load Applications
- Industrial Power
- Sensitive RF Applications

### General Description

The MIC69153 is the 1.5A output current member of the MIC69xxx family of high current, low voltage regulators, that support currents of 1A, 1.5A, 3A, and 5A. The MIC69153 operates from a single low voltage supply, yet offers high precision and ultra-low dropout of 500 mV under worst case conditions.

The MIC69153 operates from an input voltage of 1.65V to 5.5V. It is designed to drive digital circuits requiring low voltage at high currents (i.e. PLDs, DSP, microcontroller, etc.). These regulators are available only in adjustable output voltage option and can support output voltages down to 0.5V.

The  $\mu$ Cap design of the MIC69153 is optimized for stability with low value low ESR ceramic output capacitors.

Features of the MIC69153 include thermal shutdown and current-limit protection. Logic enable and error flag pins are also available.

The MIC69153 is offered in a tiny 10-pin 3 mm x 3 mm DFN package and an ePAD SOIC-8 package. Both packages have an operating temperature range of  $-40^{\circ}\text{C}$  to  $+125^{\circ}\text{C}$ .

### Typical Application Circuit

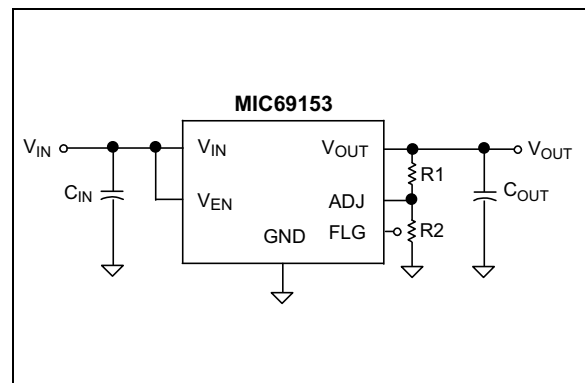



## 1.0 ELECTRICAL CHARACTERISTICS

### Absolute Maximum Ratings †

Supply Input Voltage ( $V_{IN}$ )	+6V
Logic Input Voltage ( $V_{EN}$ )	0V to $V_{IN}$
Power Dissipation ( $P_D$ ) (Note 1)	Internally Limited
Flag Pin (FLG)	+6V
ESD Rating (Note 2)	2 kV

### Operating Ratings ‡

Supply Voltage ( $V_{IN}$ )	+1.65V to +5.5V
Enable Input Voltage ( $V_{EN}$ )	0V to $V_{IN}$

† **Notice:** Stresses above those listed under “Absolute Maximum Ratings” may cause permanent damage to the device. This is a stress rating only and functional operation of the device at those or any other conditions above those indicated in the operational sections of this specification is not intended. Exposure to maximum rating conditions for extended periods may affect device reliability. Specifications are for packaged product only.

‡ **Notice:** The device is not guaranteed to function outside its operating ratings.

**Note 1:** The maximum allowable power dissipation of any  $T_A$  (ambient temperature) is  $P_{D(max)} = (T_{J(max)} - T_A) / \theta_{JA}$ . Exceeding the maximum allowable power dissipation will result in excessive die temperature and the regulator will go into thermal shutdown.

**2:** Devices are ESD sensitive. Handling precautions are recommended. Human body model, 1.5 k $\Omega$  in series with 100 pF

**TABLE 1-1: ELECTRICAL CHARACTERISTICS**

**Electrical Characteristics:**  $T_A = +25^\circ\text{C}$  with  $V_{IN} = V_{OUT} + 1\text{V}$ ; **Bold** values indicate  $-40^\circ\text{C} \leq T_J \leq +125^\circ\text{C}$ ;  $I_{OUT} = 10\text{ mA}$ ;  $C_{OUT} = 4.7\ \mu\text{F}$  ceramic, unless otherwise noted.

Parameter	Symbol	Min.	Typ.	Max.	Units	Conditions
Output Voltage Accuracy	$V_{OUT}$	<b>-2</b>	—	<b>+2</b>	%	Overtemperature range (The precision of the resistive divider is not included)
Adjustable Feedback Voltage	$V_{FB}$	<b>0.49</b>	0.5	<b>0.51</b>	V	—
Feedback Pin Current	$I_{FB}$	—	0.25	1	$\mu\text{A}$	—
Output Voltage Line Regulation (Note 1)	$\Delta V_{OUT}/\Delta V_{IN}$	—	$\pm 0.2$	$\pm 0.3$	%/V	$V_{IN} = V_{OUT} + 1.0\text{V}$ to 5.5V For $V_{OUT} \geq 0.65\text{V}$ , $V_{IN} = 1.65\text{V}$ to 5.5V
Output Voltage Load Regulation	$\Delta V_{OUT}/V_{OUT}$	—	$\pm 0.2$	—	%	$I_L = 10\text{ mA}$ to 1.5A
$V_{IN} - V_{OUT}$ ; Dropout Voltage (Note 2)	$V_{DO}$	—	185	<b>300</b>	mV	$I_L = 1.0\text{A}$
			250	<b>500</b>	mV	$I_L = 1.5\text{A}$
Ground Pin Current	$I_{GND}$	—	1.6	—	mA	$I_L = 10\text{ mA}$
			7.5	<b>20</b>	mA	$I_L = 0.5\text{A}$
			20	<b>35</b>	mA	$I_L = 1.5\text{A}$
Ground Pin Current in Shutdown	$I_{SHDN}$	—	1	—	$\mu\text{A}$	$V_{EN} = 0\text{V}$
Current Limit	$I_{LIM}$	<b>1.7</b>	2.6	—	A	$V_{OUT} = 0\text{V}$
Start-Up Time	$t_{START}$	—	10	<b>150</b>	$\mu\text{s}$	$V_{EN} = V_{IN}$
Thermal Shutdown	$T_{SHDN}$	—	165	—	$^\circ\text{C}$	—
<b>Enable Input</b>						
Enable Input Threshold	$V_{EN}$	<b>0.8</b>	0.6	—	V	Regulator enable
		—	—	<b>0.2</b>	V	Regulator shutdown

# MIC69153

**TABLE 1-1: ELECTRICAL CHARACTERISTICS (CONTINUED)**

**Electrical Characteristics:**  $T_A = +25^\circ\text{C}$  with  $V_{IN} = V_{OUT} + 1\text{V}$ ; **Bold** values indicate  $-40^\circ\text{C} \leq T_J \leq +125^\circ\text{C}$ ;  $I_{OUT} = 10\text{ mA}$ ;  $C_{OUT} = 4.7\ \mu\text{F}$  ceramic, unless otherwise noted.

Parameter	Symbol	Min.	Typ.	Max.	Units	Conditions
Enable Pin Input Current	$I_{EN}$	—	0.005	—	$\mu\text{A}$	$V_{IL} \leq 0.2\text{V}$ (Regulator shutdown)
		—	7	—	$\mu\text{A}$	$V_{IH} \geq 0.8\text{V}$ (Regulator enable)
<b>Flag Output</b>						
Flag Output Leakage Current	$I_{FLG(LEAK)}$	—	0.05	—	$\mu\text{A}$	Flag off
Output Logic-Low Voltage (Undervoltage Condition)	$V_{FLG(LO)}$	—	150	—	mV	$I_L = 5\text{ mA}$
Flag Threshold	$V_{FLG}$	7.5	10	14	%	% of $V_{OUT}$ below nominal (falling)
Hysteresis	—	—	2	—	%	—

- 1: Minimum input for line regulation test is set to  $V_{OUT} + 1\text{V}$  relative to the highest output voltage.
- 2: Dropout voltage is defined as the input-to-output differential at which the output voltage drops 2% below its nominal value measured at 1V differential. For outputs below 1.65V, dropout voltage is considered the input-to-output voltage differential with the minimum input voltage of 1.65V. Minimum input operating voltage is 1.65V.

## TEMPERATURE SPECIFICATIONS (Note 1)

Parameters	Sym.	Min.	Typ.	Max.	Units	Conditions
<b>Temperature Ranges</b>						
Storage Temperature Range	$T_S$	-65	—	+125	°C	—
Junction Temperature Range	$T_J$	-40	—	+125	°C	—
<b>Package Thermal Resistances</b>						
Thermal Resistance DFN-10	$\theta_{JA}$	—	60	—	°C/W	—
Thermal Resistance ePAD SOIC-8	$\theta_{JA}$	—	41	—	°C/W	—

**Note 1:** The maximum allowable power dissipation is a function of ambient temperature, the maximum allowable junction temperature and the thermal resistance from junction to air (i.e.,  $T_A$ ,  $T_J$ ,  $\theta_{JA}$ ). Exceeding the maximum allowable power dissipation will cause the device operating junction temperature to exceed the maximum +125°C rating. Sustained junction temperatures above +125°C can impact the device reliability.

# MIC69153

## 2.0 TYPICAL PERFORMANCE CURVES

**Note:** The graphs and tables provided following this note are a statistical summary based on a limited number of samples and are provided for informational purposes only. The performance characteristics listed herein are not tested or guaranteed. In some graphs or tables, the data presented may be outside the specified operating range (e.g., outside specified power supply range) and therefore outside the warranted range.

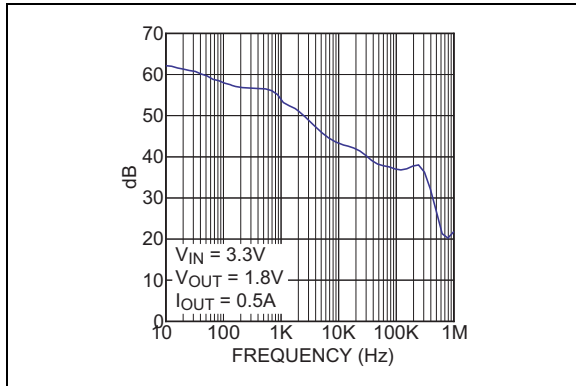

**FIGURE 2-1:** Power Supply Rejection Ratio.

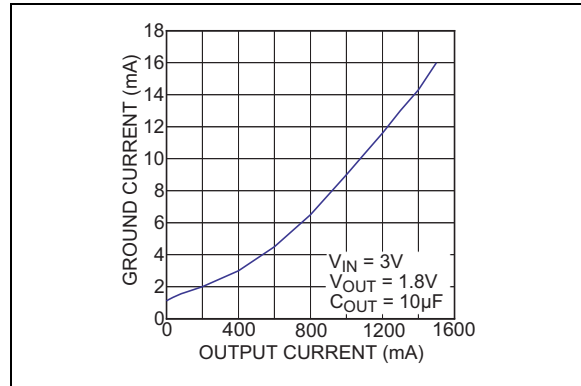

**FIGURE 2-4:** Ground Current vs. Output Current.

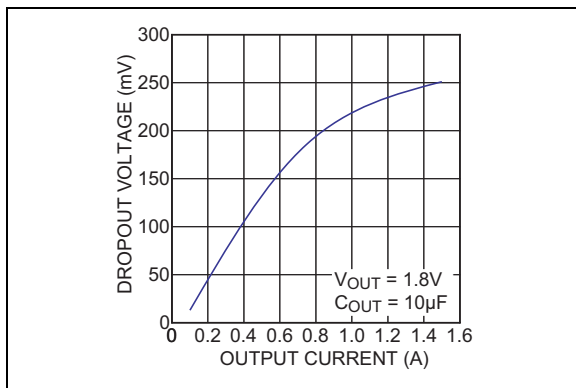

**FIGURE 2-2:** Dropout Voltage vs. Output Current.

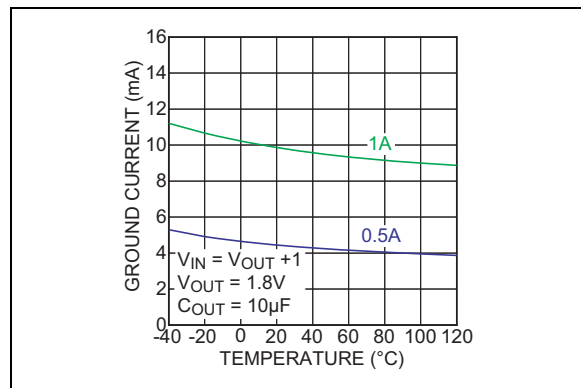

**FIGURE 2-5:** Ground Current vs. Temperature.

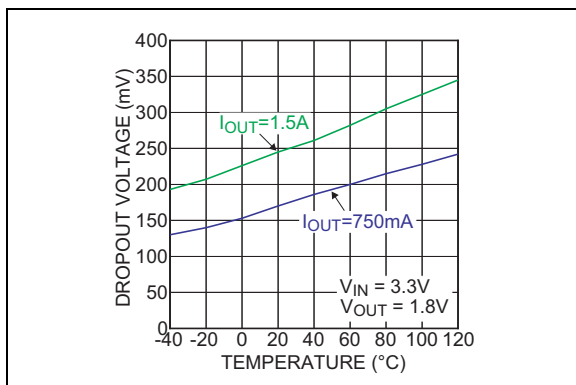

**FIGURE 2-3:** Dropout Voltage vs. Temperature.

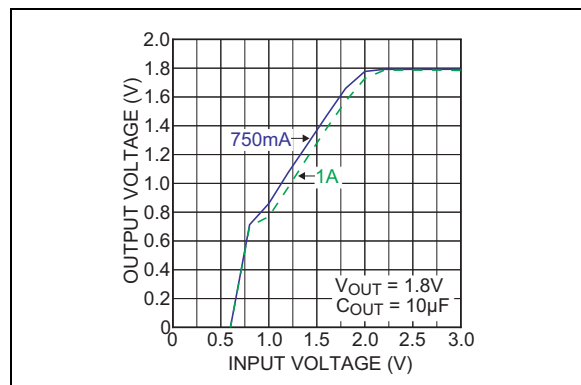

**FIGURE 2-6:** Output Voltage vs. Input Voltage.

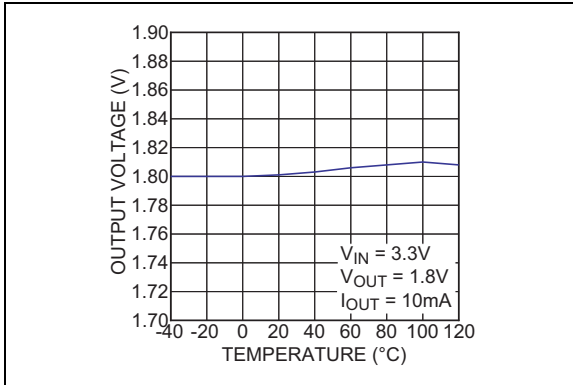

**FIGURE 2-7:** Output Voltage vs. Temperature.

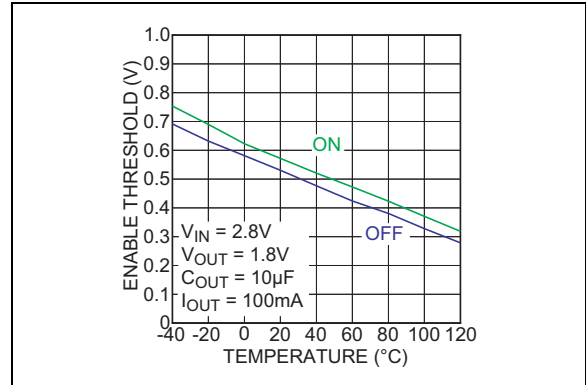

**FIGURE 2-10:** Enable Threshold vs. Temperature.

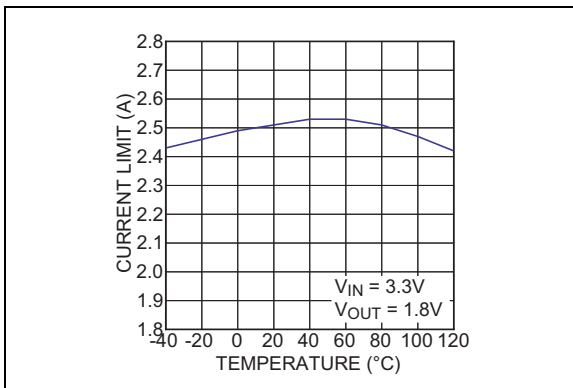

**FIGURE 2-8:** Current-Limit vs. Temperature.

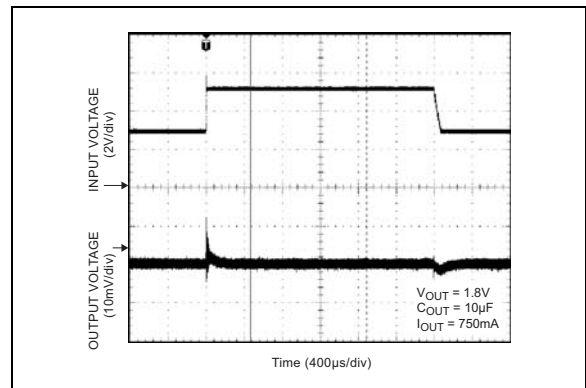

**FIGURE 2-11:** Line Transient.

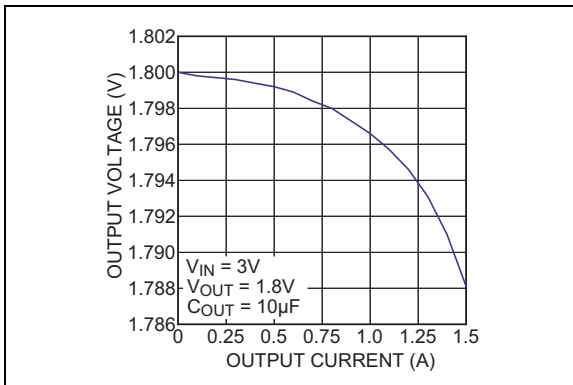

**FIGURE 2-9:** Load Regulation.

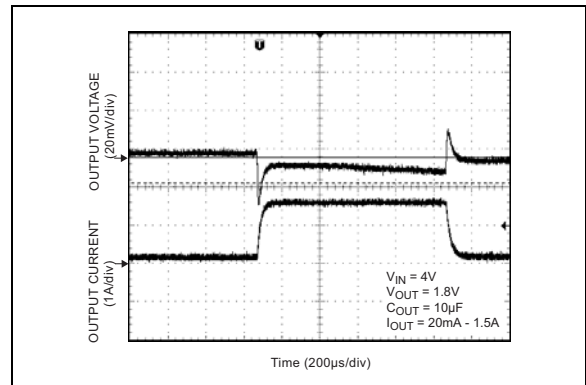

**FIGURE 2-12:** Load Transient.

# MIC69153

---

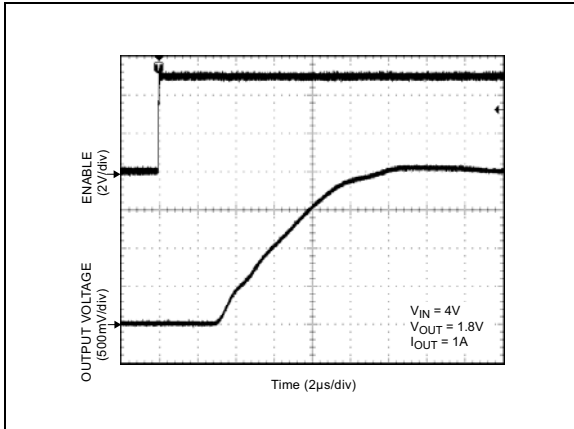

**FIGURE 2-13:** *Enable Turn-On.*

## 3.0 PIN DESCRIPTIONS

The descriptions of the pins are listed in [Table 3-1](#).

**TABLE 3-1: PIN FUNCTION TABLE**

Pin Number DFN-10	Pin Number ePAD SOIC-8	Pin Name	Description
1	8	FLG	Error Flag (Output): Open collector output. Active-low indicates an output fault condition.
2, 4, 5, 8	—	NC	Not internally connected.
3 (EP)	1	GND	Ground (exposed pad is recommended to connect to ground on DFN).
6	2	EN	Enable (Input): CMOS compatible input. Logic-high = enable, logic-low = shutdown. Do not leave pin floating.
7	3, 4	VIN	Input voltage that supplies current to the output power device.
9	5, 6	VOUT	Regulator Output.
10	7	ADJ	Adjustable regulator feedback input. Connect to resistor voltage divider.

# MIC69153

## 4.0 APPLICATION INFORMATION

The MIC69153 is an ultra-high performance low dropout linear regulator designed for high current applications that require a fast transient response. It utilizes a single input supply, perfect for low voltage DC-to-DC conversion. The MIC69153 requires a minimum number of external components. The MIC69153 regulator is fully protected from damage due to fault conditions offering constant current limiting and thermal shutdown.

### 4.1 Input Supply Voltage

$V_{IN}$  provides a high current to the collector of the pass transistor. The minimum input voltage is 1.65V allowing conversion from low voltage supplies.

### 4.2 Input Capacitor

An input capacitor of 1  $\mu$ F or greater is recommended when the device is more than 4 inches away from the bulk AC supply capacitance or when the supply is a battery. Small, surface mount, ceramic chip capacitors can be used for bypassing. The capacitor should be placed within 1 inch of the device for optimal performance. Larger values will help to improve ripple rejection by bypassing the input to the regulator, further improving the integrity of the output voltage.

### 4.3 Output Capacitor

The MIC69153 requires a minimum of output capacitance to maintain stability. However, proper capacitor selection is important to ensure desired transient response. The MIC69153 is specifically designed to be stable with low ESR ceramic chip capacitors. A 4.7  $\mu$ F ceramic chip capacitor should satisfy most applications. Output capacitor can be increased without bound. See **Section 2.0 “Typical Performance Curves”** for examples of load transient response.

X7R dielectric ceramic capacitors are recommended because of their temperature performance. X7R-type capacitors change capacitance by only 15% over their operating temperature range and are the most stable type of ceramic capacitors. Z5U and Y5V dielectric capacitors change value by as much as 50% and 60%, respectively over their operating temperature ranges. To use a ceramic chip capacitor with Y5V dielectric the value must be much higher than an X7R ceramic or a tantalum capacitor to ensure the same capacitance value over the operating temperature range. Tantalum capacitors have a very stable dielectric (10% over their operating temperature range) and can also be used with this device.

### 4.4 Minimum Load Current

The MIC69153 regulator is specified between finite loads. If the output current is too small, leakage currents dominate and the output voltage rises. A minimum 10 mA load current is necessary for proper operation.

### 4.5 Adjustable Regulator Design

The MIC69153 adjustable version allows programming the output voltage anywhere between 0.5V and 5.5V with two resistors. The resistor value between  $V_{OUT}$  and the adjust pin should not exceed 10 k $\Omega$ . Larger values can cause instability. The resistor values are calculated by:

#### EQUATION 4-1:

$$V_{OUT} = 0.5 \left( \frac{R1}{R2} + 1 \right)$$

Where:

$V_{OUT}$  is the desired output voltage

### 4.6 Enable

The MIC69153 features an active high enable input (EN) that allows on-off control of the regulator. Current drain reduces to near “zero” when the device is shutdown, with only microamperes of leakage current. EN may be directly tied to  $V_{IN}$  and pulled up to the maximum supply voltage.

### 4.7 Thermal Design

Linear regulators are simple to use. The most complicated design parameters to consider are thermal characteristics. Thermal design requires the following application-specific parameters:

- Maximum ambient temperature ( $T_A$ )
- Output current ( $I_{OUT}$ )
- Output voltage ( $V_{OUT}$ )
- Input voltage ( $V_{IN}$ )
- Ground current ( $I_{GND}$ )

First, calculate the power dissipation of the regulator from these numbers and the device parameters from this data sheet.

## EQUATION 4-2:

$$P_D = (V_{IN} - V_{OUT})I_{OUT} + V_{IN} \times I_{GND}$$

In [Equation 4-2](#), the ground current is approximated by using numbers from the **Section 1.0 “Electrical Characteristics”** or **Section 2.0 “Typical Performance Curves”** sections. The maximum allowable power dissipation of any  $T_A$  (ambient temperature) is  $P_{D(MAX)} = (T_{J(MAX)} - T_A) / \theta_{JA}$ . Exceeding the maximum allowable power dissipation will result in excessive die temperature and the regulator will go into thermal shutdown.

Refer to [Application Note 9](#) for further details and examples on thermal design and heat sink applications.

# MIC69153

## 5.0 PACKAGING INFORMATION

### 5.1 Package Marking Information

8-Lead ePAD SOIC\*

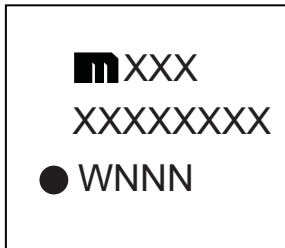

Example

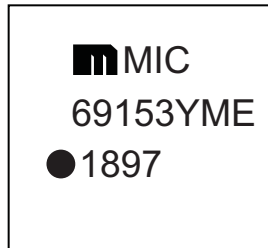

10-Lead DFN\*

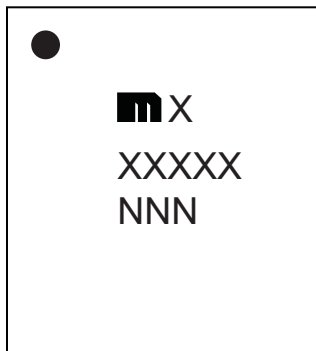

Example

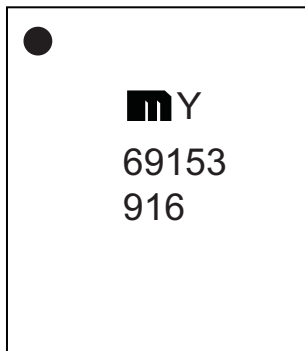

<b>Legend:</b>	XX...X	Product code or customer-specific information
	Y	Year code (last digit of calendar year)
	YY	Year code (last 2 digits of calendar year)
	WW	Week code (week of January 1 is week '01')
	NNN	Alphanumeric traceability code
	(e3)	Pb-free JEDEC® designator for Matte Tin (Sn)
	*	This package is Pb-free. The Pb-free JEDEC designator (e3) can be found on the outer packaging for this package.
	●, ▲, ▼	Pin one index is identified by a dot, delta up, or delta down (triangle mark).
<b>Note:</b>	In the event the full Microchip part number cannot be marked on one line, it will be carried over to the next line, thus limiting the number of available characters for customer-specific information. Package may or may not include the corporate logo.	
	Underbar (¯) and/or Overbar (˘) symbol may not be to scale.	

## 10-Lead 3 mm x 3 mm DFN Package Outline and Recommended Land Pattern

**TITLE**

10 LEAD DFN 3x3mm PACKAGE OUTLINE & RECOMMENDED LAND PATTERN

<b>DRAWING #</b>	DFN33-10LD-PL-1	<b>UNIT</b>	MM
------------------	-----------------	-------------	----

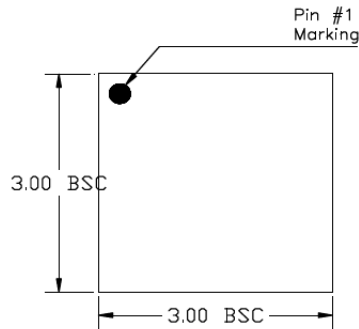

TOP VIEW  
NOTE: 1, 2, 3

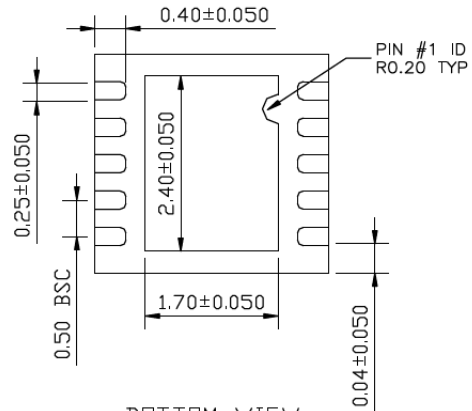

BOTTOM VIEW  
NOTE: 1, 2, 3

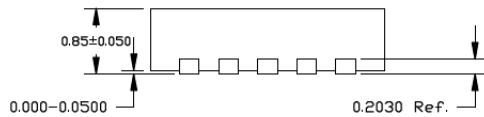

SIDE VIEW  
NOTE: 1, 2, 3

**NOTE:**

1. MAX PACKAGE WARPAGE IS 0.05 MM
2. MAX ALLOWABLE BURR IS 0.076MM IN ALL DIRECTIONS
3. PIN #1 IS ON TOP WILL BE LASER MARKED
4. RED CIRCLE IN LAND PATTERN INDICATE THERMAL VIA. SIZE SHOULD BE 0.30-0.35 MM IN DIAMETER AND SHOULD BE CONNECTED TO GND FOR MAX THERMAL PERFORMANCE
5. GREEN RECTANGLES (SHADED AREA) indicate SOLDER STENCIL OPENING ON EXPOSED PAD AREA. SIZE SHOULD BE 0.50x0.95 MM IN SIZE, 0.20 MM SPACING.

Note: For the most current package drawings, please see the Microchip Packaging Specification located at <http://www.microchip.com/packaging>.

# MIC69153

## 10-Lead 3mm x 3 mm DFN Package Outline and Recommended Land Pattern

POD-Land Pattern drawing #DFN33-10LD-PL-1

### RECOMMENDED LAND PATTERN

NOTE: 4, 5

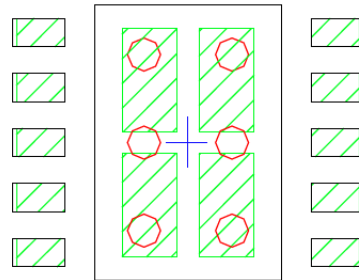

STACKED-UP

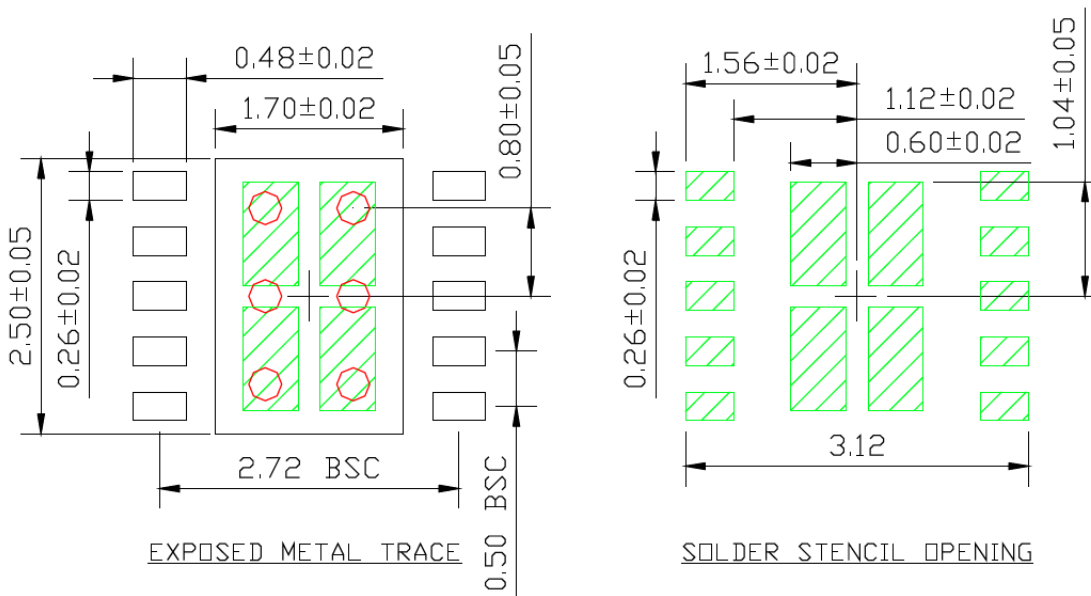

Note: For the most current package drawings, please see the Microchip Packaging Specification located at <http://www.microchip.com/packaging>.

## 8-Lead SOICN ePAD Package Outline and Recommended Land Pattern

**TITLE**

8 LEAD SOICN EPAD PACKAGE OUTLINE & RECOMMENDED LAND PATTERN

DRAWING #	SOICNEP-8LD-PL-1	UNIT	INCH [MM]
-----------	------------------	------	-----------

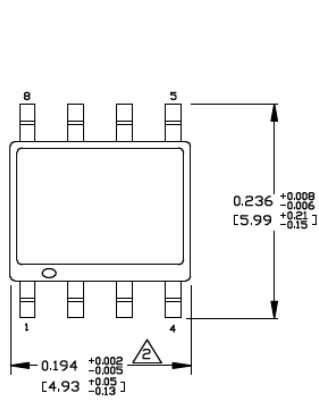

TOP VIEW

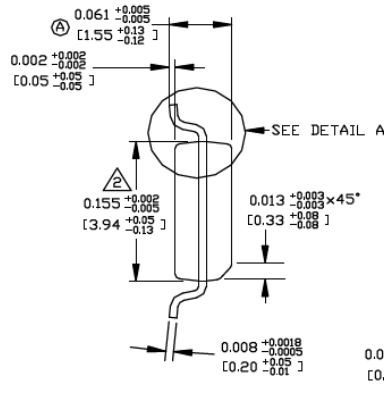

END VIEW

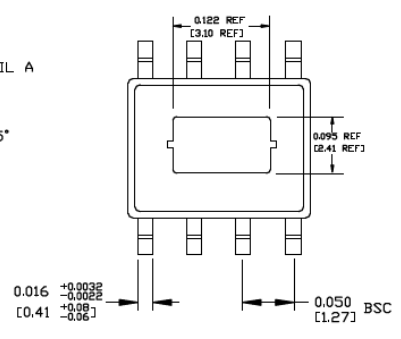

BOTTOM VIEW

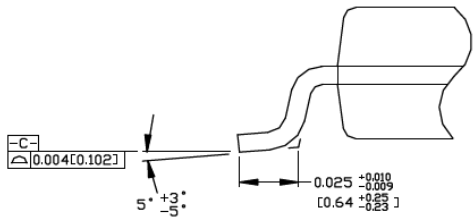

DETAIL "A"

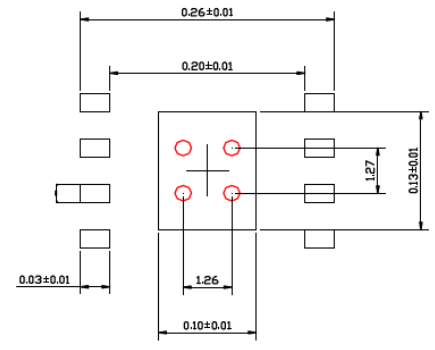

RECOMMENDED LAND PATTERN

**NOTE:**

- DIMENSION DOES NOT INCLUDE MOLD FLASH OR PROTRUSIONS, EITHER OF WHICH SHALL EXCEED 0.006 INCHES PER SIDE
- RED CIRCLES IN LAND PATTERN REPRESENT THERMAL VIAS. RECOMMENDED SIZE IS 0.30-0.30MM IN DIAMETER AND SHOULD BE CONNECTED TO GND FOR MAXIMUM THERMAL PERFORMANCE

Note: For the most current package drawings, please see the Microchip Packaging Specification located at <http://www.microchip.com/packaging>.

# MIC69153

---

NOTES:

## APPENDIX A: REVISION HISTORY

### Revision A (May 2018)

- Converted Micrel document MIC69153 to Microchip data sheet DS20006019A.
- All references to the MIC69151 have been removed from the data sheet as the part is discontinued.
- Minor text changes throughout.

# MIC69153

---

NOTES:

## PRODUCT IDENTIFICATION SYSTEM

To order or obtain information, e.g., on pricing or delivery, contact your local Microchip representative or sales office.

<u>PART NO.</u>	<u>-X</u>	<u>X</u>	<u>XX</u>	<u>-XX</u>
Device	Output Voltage	Junction Temperature Range	Package	Media Type
<b>Device:</b> MIC69153: Single Supply $V_{IN}$ , LOW $V_{IN}$ , LOW $V_{OUT}$ , 1.5A LDO (Adjustable)	<b>Output Voltage:</b> <blank> = Adjustable	<b>Junction Temperature Range:</b> Y = -40°C to +125°C, Extended Industrial, Pb-Free, RoHS Compliant	<b>Package:</b> ML = 10-Lead DFN 3 mm x 3 mm x 0.9 mm ME = 8-Lead ePAD SOIC	<b>Media Type:</b> TR = 2500/Reel (ME, ePAD SOIC) TR = 5000/Reel (ML, DFN)

**Examples:**

a) MIC69153YME-TR: Single Supply  $V_{IN}$ , Low  $V_{IN}$ , Low  $V_{OUT}$ , 1.5A LDO, Adjustable Output Voltage, -40°C to +125°C Junction Temperature Range, 8-Lead SOIC Package, 2500/Reel

b) MIC69153YML-TR: Single Supply  $V_{IN}$ , Low  $V_{IN}$ , Low  $V_{OUT}$ , 1.5A LDO, Adjustable Output Voltage, -40°C to +125°C Junction Temperature Range, 10-Lead DFN, 5,000/Reel

**Note 1:** Tape and Reel identifier only appears in the catalog part number description. This identifier is used for ordering purposes and is not printed on the device package. Check with your Microchip Sales Office for package availability with the Tape and Reel option.

# MIC69153

---

NOTES:

---

**Note the following details of the code protection feature on Microchip devices:**

- Microchip products meet the specification contained in their particular Microchip Data Sheet.
- Microchip believes that its family of products is one of the most secure families of its kind on the market today, when used in the intended manner and under normal conditions.
- There are dishonest and possibly illegal methods used to breach the code protection feature. All of these methods, to our knowledge, require using the Microchip products in a manner outside the operating specifications contained in Microchip's Data Sheets. Most likely, the person doing so is engaged in theft of intellectual property.
- Microchip is willing to work with the customer who is concerned about the integrity of their code.
- Neither Microchip nor any other semiconductor manufacturer can guarantee the security of their code. Code protection does not mean that we are guaranteeing the product as “unbreakable.”

Code protection is constantly evolving. We at Microchip are committed to continuously improving the code protection features of our products. Attempts to break Microchip's code protection feature may be a violation of the Digital Millennium Copyright Act. If such acts allow unauthorized access to your software or other copyrighted work, you may have a right to sue for relief under that Act.

---

Information contained in this publication regarding device applications and the like is provided only for your convenience and may be superseded by updates. It is your responsibility to ensure that your application meets with your specifications. MICROCHIP MAKES NO REPRESENTATIONS OR WARRANTIES OF ANY KIND WHETHER EXPRESS OR IMPLIED, WRITTEN OR ORAL, STATUTORY OR OTHERWISE, RELATED TO THE INFORMATION, INCLUDING BUT NOT LIMITED TO ITS CONDITION, QUALITY, PERFORMANCE, MERCHANTABILITY OR FITNESS FOR PURPOSE. Microchip disclaims all liability arising from this information and its use. Use of Microchip devices in life support and/or safety applications is entirely at the buyer's risk, and the buyer agrees to defend, indemnify and hold harmless Microchip from any and all damages, claims, suits, or expenses resulting from such use. No licenses are conveyed, implicitly or otherwise, under any Microchip intellectual property rights unless otherwise stated.

*Microchip received ISO/TS-16949:2009 certification for its worldwide headquarters, design and wafer fabrication facilities in Chandler and Tempe, Arizona; Gresham, Oregon and design centers in California and India. The Company's quality system processes and procedures are for its PIC® MCUs and dsPIC® DSCs, KEELoQ® code hopping devices, Serial EEPROMs, microperipherals, nonvolatile memory and analog products. In addition, Microchip's quality system for the design and manufacture of development systems is ISO 9001:2000 certified.*

**QUALITY MANAGEMENT SYSTEM  
CERTIFIED BY DNV  
= ISO/TS 16949 =**

**Trademarks**

The Microchip name and logo, the Microchip logo, AnyRate, AVR, AVR logo, AVR Freaks, BeaconThings, BitCloud, CryptoMemory, CryptoRF, dsPIC, FlashFlex, flexPWR, Helder, JukeBlox, KEELoQ, KEELoQ logo, Klear, LANCheck, LINK MD, maXStylus, maXTouch, MediaLB, megaAVR, MOST, MOST logo, MPLAB, OptoLyzer, PIC, picoPower, PICSTART, PIC32 logo, Prochip Designer, QTouch, RightTouch, SAM-BA, SpyNIC, SST, SST Logo, SuperFlash, tinyAVR, UNI/O, and XMEGA are registered trademarks of Microchip Technology Incorporated in the U.S.A. and other countries.

ClockWorks, The Embedded Control Solutions Company, EtherSynch, Hyper Speed Control, HyperLight Load, IntelliMOS, mTouch, Precision Edge, and Quiet-Wire are registered trademarks of Microchip Technology Incorporated in the U.S.A.

Adjacent Key Suppression, AKS, Analog-for-the-Digital Age, Any Capacitor, AnyIn, AnyOut, BodyCom, chipKIT, chipKIT logo, CodeGuard, CryptoAuthentication, CryptoCompanion, CryptoController, dsPICDEM, dsPICDEM.net, Dynamic Average Matching, DAM, ECAN, EtherGREEN, In-Circuit Serial Programming, ICSP, Inter-Chip Connectivity, JitterBlocker, KlearNet, KlearNet logo, Mindi, MiWi, motorBench, MPASM, MPF, MPLAB Certified logo, MPLIB, MPLINK, MultiTRAK, NetDetach, Omniscient Code Generation, PICDEM, PICDEM.net, PICKit, PICTail, PureSilicon, QMatrix, RightTouch logo, REAL ICE, Ripple Blocker, SAM-ICE, Serial Quad I/O, SMART-I.S., SQI, SuperSwitcher, SuperSwitcher II, Total Endurance, TSHARC, USBCheck, VariSense, ViewSpan, WiperLock, Wireless DNA, and ZENA are trademarks of Microchip Technology Incorporated in the U.S.A. and other countries.

SQTP is a service mark of Microchip Technology Incorporated in the U.S.A.

Silicon Storage Technology is a registered trademark of Microchip Technology Inc. in other countries.

GestIC is a registered trademark of Microchip Technology Germany II GmbH & Co. KG, a subsidiary of Microchip Technology Inc., in other countries.

All other trademarks mentioned herein are property of their respective companies.

© 2018, Microchip Technology Incorporated, All Rights Reserved.  
ISBN: 978-1-5224-3085-8



# MICROCHIP

## Worldwide Sales and Service

### AMERICAS

**Corporate Office**  
2355 West Chandler Blvd.  
Chandler, AZ 85224-6199  
Tel: 480-792-7200  
Fax: 480-792-7277  
Technical Support:  
<http://www.microchip.com/support>  
Web Address:  
[www.microchip.com](http://www.microchip.com)

**Atlanta**  
Duluth, GA  
Tel: 678-957-9614  
Fax: 678-957-1455

**Austin, TX**  
Tel: 512-257-3370

**Boston**  
Westborough, MA  
Tel: 774-760-0087  
Fax: 774-760-0088

**Chicago**  
Itasca, IL  
Tel: 630-285-0071  
Fax: 630-285-0075

**Dallas**  
Addison, TX  
Tel: 972-818-7423  
Fax: 972-818-2924

**Detroit**  
Novi, MI  
Tel: 248-848-4000

**Houston, TX**  
Tel: 281-894-5983

**Indianapolis**  
Noblesville, IN  
Tel: 317-773-8323  
Fax: 317-773-5453  
Tel: 317-536-2380

**Los Angeles**  
Mission Viejo, CA  
Tel: 949-462-9523  
Fax: 949-462-9608  
Tel: 951-273-7800

**Raleigh, NC**  
Tel: 919-844-7510

**New York, NY**  
Tel: 631-435-6000

**San Jose, CA**  
Tel: 408-735-9110  
Tel: 408-436-4270

**Canada - Toronto**  
Tel: 905-695-1980  
Fax: 905-695-2078

### ASIA/PACIFIC

**Australia - Sydney**  
Tel: 61-2-9868-6733

**China - Beijing**  
Tel: 86-10-8569-7000

**China - Chengdu**  
Tel: 86-28-8665-5511

**China - Chongqing**  
Tel: 86-23-8980-9588

**China - Dongguan**  
Tel: 86-769-8702-9880

**China - Guangzhou**  
Tel: 86-20-8755-8029

**China - Hangzhou**  
Tel: 86-571-8792-8115

**China - Hong Kong SAR**  
Tel: 852-2943-5100

**China - Nanjing**  
Tel: 86-25-8473-2460

**China - Qingdao**  
Tel: 86-532-8502-7355

**China - Shanghai**  
Tel: 86-21-3326-8000

**China - Shenyang**  
Tel: 86-24-2334-2829

**China - Shenzhen**  
Tel: 86-755-8864-2200

**China - Suzhou**  
Tel: 86-186-6233-1526

**China - Wuhan**  
Tel: 86-27-5980-5300

**China - Xian**  
Tel: 86-29-8833-7252

**China - Xiamen**  
Tel: 86-592-2388138

**China - Zhuhai**  
Tel: 86-756-3210040

### ASIA/PACIFIC

**India - Bangalore**  
Tel: 91-80-3090-4444

**India - New Delhi**  
Tel: 91-11-4160-8631

**India - Pune**  
Tel: 91-20-4121-0141

**Japan - Osaka**  
Tel: 81-6-6152-7160

**Japan - Tokyo**  
Tel: 81-3-6880-3770

**Korea - Daegu**  
Tel: 82-53-744-4301

**Korea - Seoul**  
Tel: 82-2-554-7200

**Malaysia - Kuala Lumpur**  
Tel: 60-3-7651-7906

**Malaysia - Penang**  
Tel: 60-4-227-8870

**Philippines - Manila**  
Tel: 63-2-634-9065

**Singapore**  
Tel: 65-6334-8870

**Taiwan - Hsin Chu**  
Tel: 886-3-577-8366

**Taiwan - Kaohsiung**  
Tel: 886-7-213-7830

**Taiwan - Taipei**  
Tel: 886-2-2508-8600

**Thailand - Bangkok**  
Tel: 66-2-694-1351

**Vietnam - Ho Chi Minh**  
Tel: 84-28-5448-2100

### EUROPE

**Austria - Wels**  
Tel: 43-7242-2244-39  
Fax: 43-7242-2244-393

**Denmark - Copenhagen**  
Tel: 45-4450-2828  
Fax: 45-4485-2829

**Finland - Espoo**  
Tel: 358-9-4520-820

**France - Paris**  
Tel: 33-1-69-53-63-20  
Fax: 33-1-69-30-90-79

**Germany - Garching**  
Tel: 49-8931-9700

**Germany - Haan**  
Tel: 49-2129-3766400

**Germany - Heilbronn**  
Tel: 49-7131-67-3636

**Germany - Karlsruhe**  
Tel: 49-721-625370

**Germany - Munich**  
Tel: 49-89-627-144-0  
Fax: 49-89-627-144-44

**Germany - Rosenheim**  
Tel: 49-8031-354-560

**Israel - Ra'anana**  
Tel: 972-9-744-7705

**Italy - Milan**  
Tel: 39-0331-742611  
Fax: 39-0331-466781

**Italy - Padova**  
Tel: 39-049-7625286

**Netherlands - Drunen**  
Tel: 31-416-690399  
Fax: 31-416-690340

**Norway - Trondheim**  
Tel: 47-7289-7561

**Poland - Warsaw**  
Tel: 48-22-3325737

**Romania - Bucharest**  
Tel: 40-21-407-87-50

**Spain - Madrid**  
Tel: 34-91-708-08-90  
Fax: 34-91-708-08-91

**Sweden - Gothenberg**  
Tel: 46-31-704-60-40

**Sweden - Stockholm**  
Tel: 46-8-5090-4654

**UK - Wokingham**  
Tel: 44-118-921-5800  
Fax: 44-118-921-5820

## Looking for pricing, stock, or lifecycle information?

Click below to explore more details on WIN SOURCE:

 [View MIC69153YME-TR on WIN SOURCE](#)

 [Microchip Technology](#) Information

## Optimize Your Supply Chain with WIN SOURCE Solutions

-  Global Sourcing Solution
-  Obsolete Management
-  Cost Control Management
-  Shortage Management
-  Alternative Solution
-  Excess Inventory Management