



MIC809/810

Microprocessor Reset Circuits

General Description

The MIC809 and MIC810 are inexpensive microprocessor supervisory circuits that monitor power supplies in microprocessor-based systems.

The function of these devices is to assert a reset if the power supply drops below a designated reset threshold level. Several different reset threshold levels are available to accommodate 3V, 3.3V or 5V powered systems.

The MIC809 has an active-low /RESET output, while the MIC810 offers an active-high RESET output. The reset output is guaranteed to remain asserted for a minimum of 140ms after V_{CC} has risen above the designated reset threshold level. Having a push-pull output stage, the MIC809/810 does not require a pull-up resistor at the output. The MIC809/810 comes in a 3-pin SOT-23 and SC-70 package.

The MIC809 is also available with a shorter reset timeout (30ms, minimum).

Datasheets and support documentation are available on Micrel's web site at: www.micrel.com.

Features

- Precision voltage monitor for 3V, 3.3V, or 5V power supplies
- /RESET remains valid with V_{CC} as low as 1.4V for SOT-23 packaged part
- /RESET remains valid with V_{CC} as low as 1V for SC70-packaged part
- Typically less than 15 μ A supply current for SOT-23 packaged part
- 5 μ A (typical) supply current for SC70-packaged part
- 140ms (minimum) reset pulse widths available
- Available in 3-pin SOT-23 and SC-70 package

Applications

- Portable equipment
- Intelligent instruments
- Critical microprocessor power monitoring
- Printers/computers
- Controllers

Typical Application

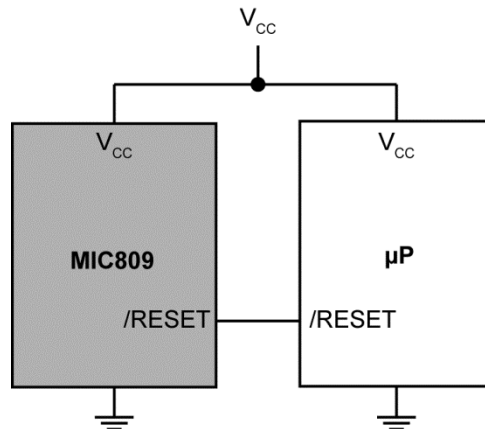

Ordering Information⁽¹⁾

Part Number		Marking ⁽²⁾	Threshold Voltage (V)	Operating Temperature Range	Lead Finish
3-Pin SOT-23	3-Pin SC-70				
MIC809LUY	MIC809LYC3	<u>IL</u>	4.63	-40°C to +85°C	Pb-Free
MIC809MUY	MIC809MYC3	<u>IM</u>	4.38	-40°C to +85°C	Pb-Free
MIC809JUY	MIC809JYC3	<u>IJ</u>	4.00	-40°C to +85°C	Pb-Free
MIC809TUY	MIC809TYC3	<u>IT</u>	3.08	-40°C to +85°C	Pb-Free
MIC809SUY	MIC809SYC3	<u>IS</u>	2.93	-40°C to +85°C	Pb-Free
MIC809RUY	MIC809RYC3	<u>IR</u>	2.63	-40°C to +85°C	Pb-Free
MIC810LUY	MIC810LYC3	<u>JL</u>	4.63	-40°C to +85°C	Pb-Free
MIC810MUY	MIC810MYC3	<u>JM</u>	4.38	-40°C to +85°C	Pb-Free
MIC810JUY	MIC810JYC3	<u>JJ</u>	4.00	-40°C to +85°C	Pb-Free
MIC810TUY	MIC810TYC3	<u>JT</u>	3.08	-40°C to +85°C	Pb-Free
MIC810SUY	MIC810SYC3	<u>JS</u>	2.93	-40°C to +85°C	Pb-Free
MIC810RUY	MIC810RYC3	<u>JR</u>	2.63	-40°C to +85°C	Pb-Free

- Note:**
1. All devices available in Tape and Reel only (Order entry PN, add TR, i.e., MIC809LUY TR). Standard/full reel quantity is 3,000 pieces. Reel diameter is 7in, hub diameter is 2in, and width is 8mm.
 2. Underbar symbol () may not be to scale.

Pin Configuration

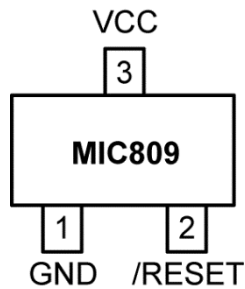

3-Pin MIC809 SOT-23
3-Pin MIC809 SC-70
(Top View)

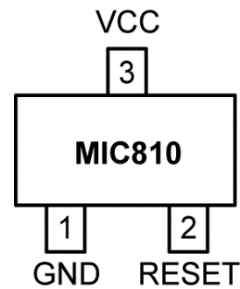

3-Pin MIC810 SOT-23
3-Pin MIC810 SC-70
(Top View)

Pin Description

Pin Number MIC809	Pin Number MIC810	Pin Name	Pin Name
1	1	GND	IC Ground Pin.
2	N/A	/RESET	/RESET goes low if V_{CC} falls below the reset threshold and remains asserted for one reset timeout period (140ms min.) after V_{CC} exceeds the reset threshold.
N/A	2	RESET	RESET goes high if V_{CC} falls below the reset threshold and remains asserted for one reset timeout period (140ms, minimum) after V_{CC} exceeds the reset threshold.
3	3	VCC	Power Supply Input.

Part Numbering Conventions

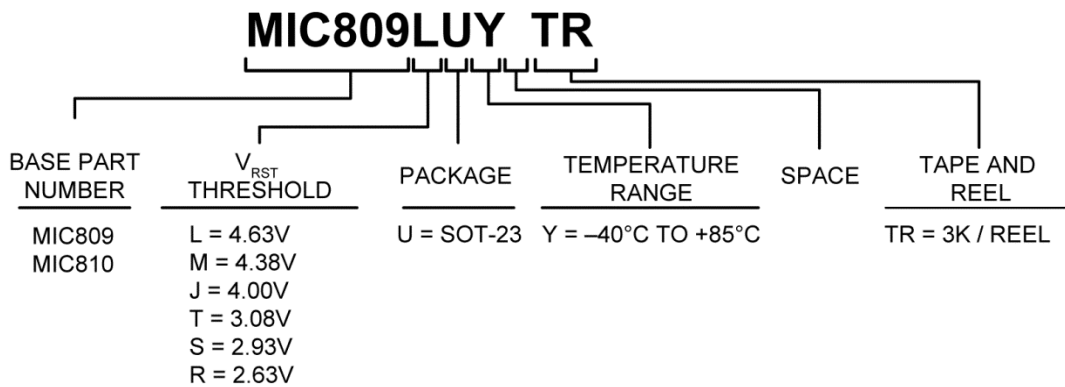

MIC809 SOT-23



MIC809 SC-70

Absolute Maximum Ratings⁽³⁾

Terminal Voltage (V_{CC}).....	-0.3V to +6.0V
Input Current (V_{CC}).....	20mA
Output Current (/RESET, RESET).....	20mA
Lead Temperature (soldering, 10s).....	300°C
Storage Temperature (T_S).....	-65°C to 150°C
Rate-of-Rise (V_{CC}).....	100V/ μ s
ESD Rating ⁽⁵⁾	3kV (SC-70)

Operating Ratings⁽⁴⁾

Operating Temperature Range	
MIC809	-40°C to +85°C
MIC810	-40°C to +85°C
Power Dissipation ($T_A = +70^\circ\text{C}$).....	320mW

Electrical Characteristics⁽⁶⁾

For typical values, $V_{CC} = 5\text{V}$ for MIC8_L/M/J, $V_{CC} = 3.3\text{V}$ for MIC8_S/T, $V_{CC} = 3\text{V}$ for MIC8_R; $T_A = 25^\circ\text{C}$.

Bold values indicate -40°C to $\leq T_A \leq +85^\circ\text{C}$; unless otherwise noted.

Symbol	Parameter	Condition	Min.	Typ.	Max.	Units
V_{CC}	Operating Voltage Range	$T_A = 0^\circ\text{C}$ to 70°C (SOT-23)	1.4		5.5	V
		$T_A = -40^\circ\text{C}$ to 85°C (SOT-23)	1.6		5.5	V
		$T_A = -40^\circ\text{C}$ to 85°C (SC70)	1		5.5	V
I_{CC}	Supply Current	MIC809L/M/J, MIC810L/M/J (SOT-23)		9	15	μA
		MIC809L/M/J, MIC810L/M/J (SC-70)		5	15	
		$V_{CC} < 3.6\text{V}$, MIC809R/S/T, MIC810R/S/T (SOT-23)		6	10	
		$V_{CC} < 3.6\text{V}$, MIC809R/S/T, MIC810R/S/T (SC-70)		5	10	
V_{TH}	Reset Voltage Threshold	MIC809L, MIC810L	4.50	4.63	4.75	V
		MIC809M, MIC810M	4.25	4.38	4.50	
		MIC809J, MIC810J	3.89	4.00	4.10	
		MIC809T, MIC810T	3.00	3.08	3.15	
		MIC809S, MIC810S	2.85	2.93	3.00	
		MIC809R, MIC810R	2.55	2.63	2.70	
t_{RST}	Reset Timeout Period		140	240	560	ms
V_{OH}	/RESET Output Voltage (MIC809)	$I_{SOURCE} = 800\mu\text{A}$, MIC809L/M/J	$V_{CC} - 1.5\text{V}$			V
		$I_{SOURCE} = 500\mu\text{A}$, MIC809R/S/T	$0.8 \times V_{CC}$			

Notes:

- Exceeding the absolute maximum ratings may damage the device.
- The device is not guaranteed to function outside its operating ratings.
- Devices are ESD sensitive. Handling precautions are recommended. Human body model, 1.5k Ω in series with 100pF.
- Specification for packaged product only.

Electrical Characteristics⁽⁶⁾ (Continued)

For typical values, $V_{CC} = 5V$ for MIC8_L/M/J, $V_{CC} = 3.3V$ for MIC8_S/T, $V_{CC} = 3V$ for MIC8_R; $T_A = 25^\circ C$.

Bold values indicate $-40^\circ C$ to $\leq T_A \leq +85^\circ C$; unless otherwise noted.

Symbol	Parameter	Condition	Min.	Typ.	Max.	Units
V_{OL}	/RESET Output Voltage (MIC809)	$V_{CC} = V_{TH}$ (minimum), $I_{SINK} = 3.2mA$, MIC809L/M/J			0.4	V
		$V_{CC} = V_{TH}$ (minimum), $I_{SINK} = 1.2mA$, MIC809R/S/T			0.3	
		$V_{CC} > 1.4V$, $I_{SINK} = 50\mu A$, $T_A = 0^\circ C$ to $+70^\circ C$			0.3	
		$V_{CC} = 1V$, $I_{SINK} = 50\mu A$, $T_A = -40^\circ C$ to $+85^\circ C$ (SC-70)			0.3	
		$V_{CC} > 1.6V$, $I_{SINK} = 50\mu A$, $T_A = -40^\circ C$ to $+85^\circ C$			0.3	
V_{OH}	RESET Output Voltage (MIC810)	$1.8V < V_{CC} < V_{TH}$ (minimum), $I_{SOURCE} = 150\mu A$	$0.8 \times V_{CC}$			V
V_{OL}	RESET Output Voltage (MIC810)	$I_{SINK} = 3.2mA$, MIC810L/M/J			0.4	V
		$I_{SINK} = 1.2mA$, MIC810R/S/T			0.3	

Timing Diagram

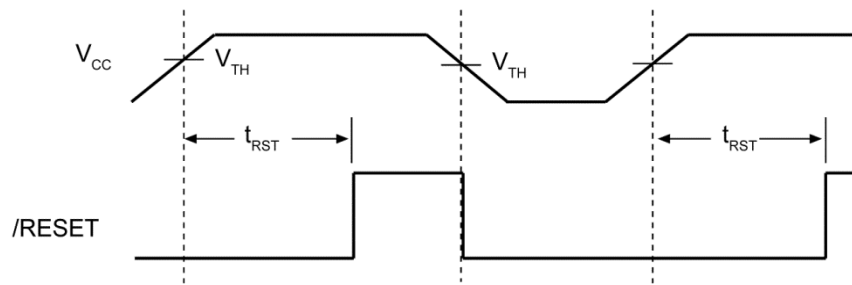

Reset Timing Diagram

Functional Diagram



Application Information

Microprocessor Reset

The /RESET (or RESET) pin is asserted whenever V_{CC} falls below the reset threshold voltage. The /RESET pin remains asserted for a period of 140ms after V_{CC} has risen above the reset threshold voltage. The reset function ensures the microprocessor is properly reset and powers up in a known condition after a power failure. /RESET will remain valid with V_{CC} as low as 1.4V (1V for SC-70 package).

V_{CC} Transients

The MIC809/810 are relatively immune to negative-going V_{CC} glitches below the reset threshold. Typically, a negative-going transient 125mV below the reset threshold with duration of 2 μ s or less (SC70 package) will not cause a reset.

Interfacing to Bidirectional Reset Pins

The MIC809/810 can interface with μ Ps with bidirectional reset pins by connecting a 4.7k Ω resistor in series with the MIC809/810 output and the μ P reset pin.

/RESET Valid at Low Voltage

A resistor can be added from the /RESET pin to ground to ensure the /RESET output remains low with V_{CC} down to 0V. A 100k Ω resistor connected from the /RESET to ground is recommended. The resistor should be small enough to pull-down any stray leakage currents and large enough not to load the reset output (Figure 1).



Figure 1. Reset Valid to $V_{CC} = 0V$

Package Information and Recommended Landing Patterns⁽⁷⁾

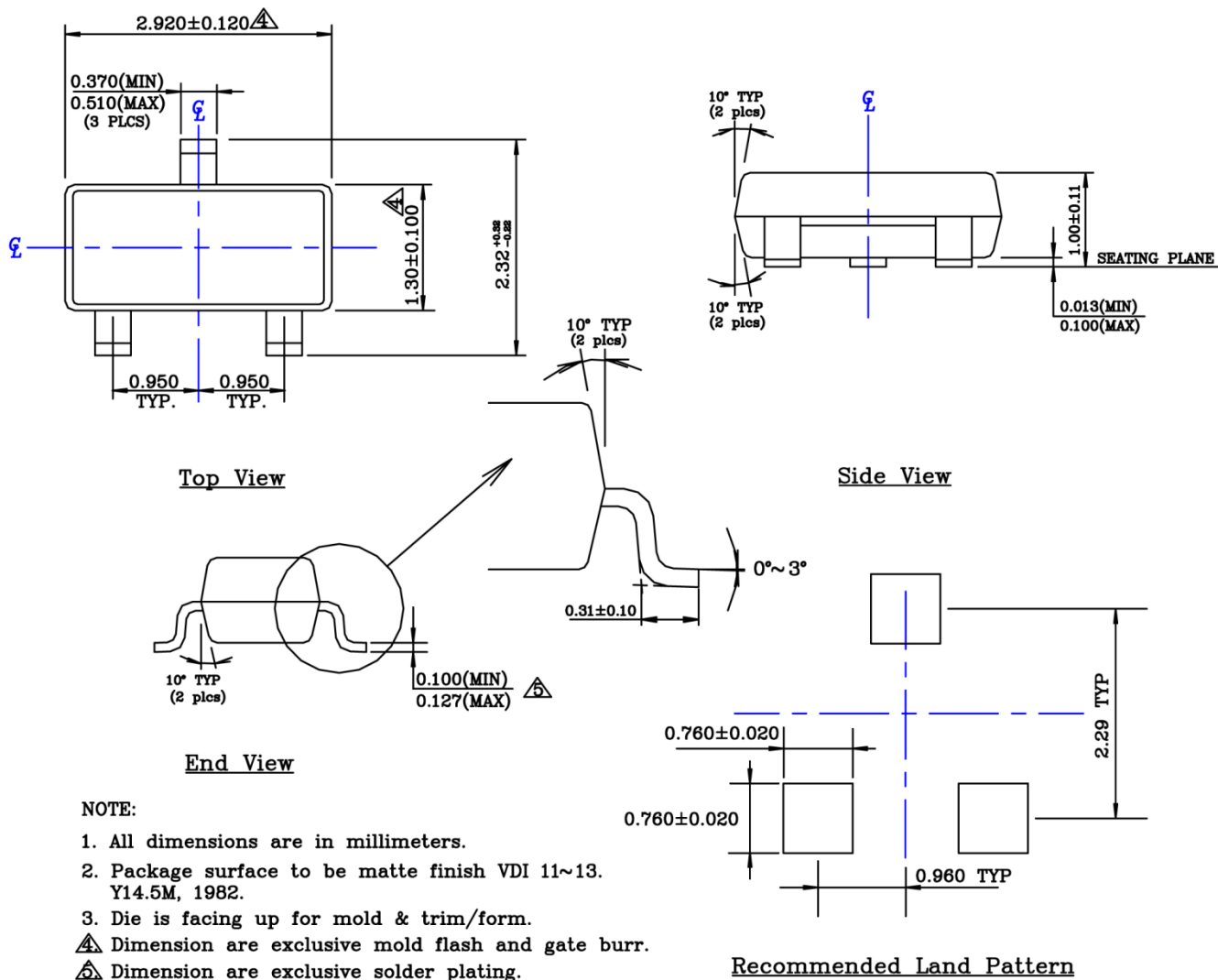

3-Pin SOT-23 (U)

Note:

7. Package information is correct as of the publication date. For updates and most current information, go to www.micrel.com.

Package Information and Recommended Landing Patterns⁽⁷⁾ (Continued)



TOP VIEW



END VIEW



SIDE VIEW

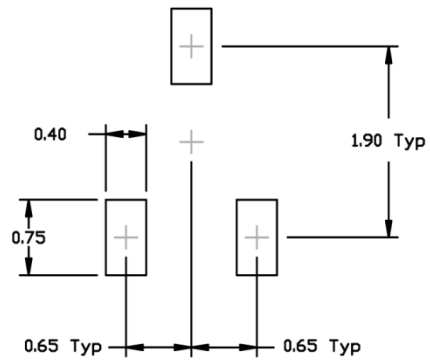

RECOMMENDED LAND PATTERN

- NOTE:
 1. ALL DIMENSIONS ARE IN MILLIMETERS.
 2. DIMENSIONS ARE INCLUSIVE OF PLATING.
 3. DIMENSIONS ARE EXCLUSIVE OF MOLD FLASH & METAL BURR.

3-Pin SC-70 (C3)

MICREL, INC. 2180 FORTUNE DRIVE SAN JOSE, CA 95131 USA
TEL +1 (408) 944-0800 FAX +1 (408) 474-1000 WEB <http://www.micrel.com>

Micrel, Inc. is a leading global manufacturer of IC solutions for the worldwide high performance linear and power, LAN, and timing & communications markets. The Company's products include advanced mixed-signal, analog & power semiconductors; high-performance communication, clock management, MEMs-based clock oscillators & crystal-less clock generators, Ethernet switches, and physical layer transceiver ICs. Company customers include leading manufacturers of enterprise, consumer, industrial, mobile, telecommunications, automotive, and computer products. Corporation headquarters and state-of-the-art wafer fabrication facilities are located in San Jose, CA, with regional sales and support offices and advanced technology design centers situated throughout the Americas, Europe, and Asia. Additionally, the Company maintains an extensive network of distributors and reps worldwide.

Micrel makes no representations or warranties with respect to the accuracy or completeness of the information furnished in this datasheet. This information is not intended as a warranty and Micrel does not assume responsibility for its use. Micrel reserves the right to change circuitry, specifications and descriptions at any time without notice. No license, whether express, implied, arising by estoppel or otherwise, to any intellectual property rights is granted by this document. Except as provided in Micrel's terms and conditions of sale for such products, Micrel assumes no liability whatsoever, and Micrel disclaims any express or implied warranty relating to the sale and/or use of Micrel products including liability or warranties relating to fitness for a particular purpose, merchantability, or infringement of any patent, copyright, or other intellectual property right.

Micrel Products are not designed or authorized for use as components in life support appliances, devices or systems where malfunction of a product can reasonably be expected to result in personal injury. Life support devices or systems are devices or systems that (a) are intended for surgical implant into the body or (b) support or sustain life, and whose failure to perform can be reasonably expected to result in a significant injury to the user. A Purchaser's use or sale of Micrel Products for use in life support appliances, devices or systems is a Purchaser's own risk and Purchaser agrees to fully indemnify Micrel for any damages resulting from such use or sale.

© 2004 Micrel, Incorporated.

Looking for pricing, stock, or lifecycle information?

Click below to explore more details on WIN SOURCE:

- ⊖ [View MIC809RUY-TR on WIN SOURCE](#)
- ⊖ [Microchip Technology Information](#)

Optimize Your Supply Chain with WIN SOURCE Solutions

- ✓ Global Sourcing Solution
- ✓ Obsolete Management
- ✓ Cost Control Management
- ✓ Shortage Management
- ✓ Alternative Solution
- ✓ Excess Inventory Management