

### General Description

The MIC94052/94053 are low on-resistance, 84mΩ(max) P-channel MOSFETs. They are housed in a *Teeny™* SC-70-6 package.

Designed for high-side switch applications where space is critical, the MIC94052/3 exhibit a typical on-resistance of 70mΩ at 4.5V gate-to-source voltage. The devices operate down to 1.8V gate-to-source voltage. Their operating voltage range makes the MIC94052/3 ideal for Li Ion applications as well as other sub-5V load switch applications.

The MIC94053 is an option that includes an internal gate pull-up resistor. The pull-up resistor ensures that the P-channel MOSFET is OFF until actively pulled down. Integrating the pull-up resistor saves valuable board space and reduces component placement cost.

The MIC94052/3 have a junction temperature range of -40°C to +150°C.

### Features

- 1.8V to 5.5V input voltage range
- Low on-resistance P-channel MOSFET:
  - 70mΩ at  $V_{GS} = 4.5V$  (typ)
  - 2A continuous current
- $V_{GS}$  pull-up resistor (MIC94053)
- *Teeny™* SC-70-6 package
- -40°C to +150°C junction temperature range

### Applications

- Load switch in portable applications:
  - Cellular phones
  - PDA's
  - MP3 players
  - Notebook PCs
  - Barcode scanners

### Ordering Information

Part Number				Gate-Source Pull Up	Junction Temp Range	Package
Standard	Marking	Pb-Free	Marking*			
MIC94052BC6	P52	MIC94052YC6	<u>P</u> 52	NO	-40°C to +150°C	SC-70-6
MIC94053BC6	P53	MIC94053YC6	<u>P</u> 53	YES	-40°C to +150°C	SC-70-6

\* Under bar symbol may not be to scale.

### Typical Application

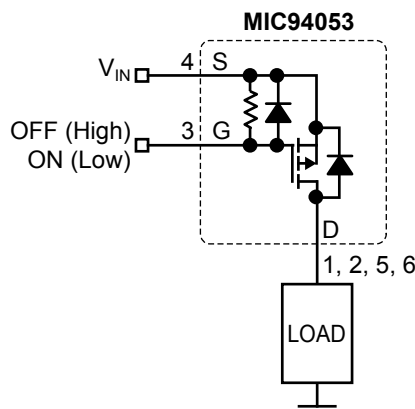

Load Switch Application

## Pin Configuration

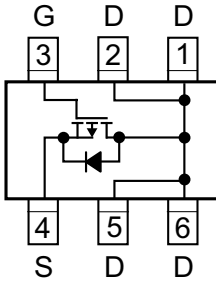

**MIC94052**  
**SC-70-6 (C6)**

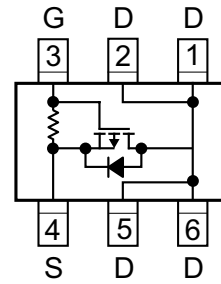

**MIC94053**  
**SC-70-6 (C6)**

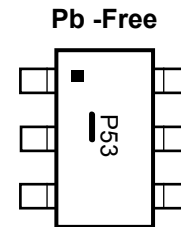
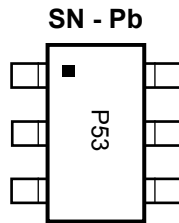

**Package Marking - Top View**

## Pin Description

Pin Number	Pin Name	Pin Function
1, 2, 5, 6	D	Drain. Ensure that all drain pins are connected together to optimize $R_{DS(ON)}$ performance.
3	G	Gate
4	S	Source

**Absolute Maximum Ratings (Note 1)**

Drain-Source Voltage ( $V_{DS}$ )	–6V
Gate-Source Voltage ( $V_{GS}$ )	–6V
Continuous Drain Current ( $I_D$ ) <b>Note 3</b>	
$T_A = 25^\circ\text{C}$	±2A
$T_A = 85^\circ\text{C}$	±1.4A
Pulsed Drain Current ( $I_{DP}$ ) <b>Note 3</b>	±6A
Continuous Diode Current ( $I_S$ ) <b>Note 7</b>	–50mA
Power Dissipation <b>Note 3</b>	
SC-70-6 lead ( $T_A = 85^\circ\text{C}$ )	270mW
Ambient Storage Temperature ( $T_S$ )	–55°C to +150°C
ESD Rating <b>Note 4</b>	

**Operating Ratings (Note 2)**

Input Voltage Range	1.8V to 5.5V
Junction Temperature Range ( $T_J$ )	–40°C to +150°C
Package Thermal Impedance <b>Note 3</b>	
$\theta_{JA}$ SC-70-6 lead	240°C/W

**Electrical Characteristics**

$T_A = 25^\circ\text{C}$ , unless otherwise specified. **Bold** values indicate  $-40^\circ\text{C} \leq T_J \leq +150^\circ\text{C}$ .

Symbol	Parameter	Condition	Min	Typ	Max	Units
<b>Static</b>						
$V_{GS(th)}$	Gate Threshold Voltage	$V_{DS} = V_{GS}$ , $I_D = -250\mu\text{A}$	–0.5		–1.2	V
$I_{GSS}$	Gate Body Leakage (MIC94052 only)	$V_{DS} = 0\text{V}$ , $V_{GS} = -5.5\text{V}$			100	nA
$R_{GS}$	Gate-Source Resistance (MIC94053 only)	$V_{DS} = 0\text{V}$ , $V_{GS} = -5.5\text{V}$	250	400	550	k $\Omega$
$I_{DSS}$	Zero Gate Voltage Drain Current	$V_{DS} = -5.5\text{V}$ , $V_{GS} = 0\text{V}$ $T_J = +85^\circ\text{C}$			–1 <b>–5</b>	$\mu\text{A}$ $\mu\text{A}$
$R_{DS(ON)}$	Drain-Source On-Resistance <b>Note 8</b>	$V_{GS} = -4.5\text{V}$ , $I_{DS} = -100\text{mA}$ $V_{GS} = -3.6\text{V}$ , $I_{DS} = -100\text{mA}$ $V_{GS} = -2.5\text{V}$ , $I_{DS} = -100\text{mA}$ $V_{GS} = -1.8\text{V}$ , $I_{DS} = -100\text{mA}$		70 76 92 125	84 110 130 180	m $\Omega$ m $\Omega$ m $\Omega$ m $\Omega$
<b>Dynamic, Note 6</b>						
$t_{d(on)}$	Turn-On Delay Time	$V_{DD} = -5\text{V}$ , $I_D = -0.5\text{A}$ , $V_{GS} = -4.5\text{V}$ , $R_{GEN} = 50\Omega$		15		ns
$t_r$	Turn-On Rise Time	$V_{DD} = -5\text{V}$ , $I_D = -0.5\text{A}$ , $V_{GS} = -4.5\text{V}$ , $R_{GEN} = 50\Omega$		15		ns
$t_{d(off)}$	Turn-Off Delay Time	$V_{DD} = -5\text{V}$ , $I_D = -0.5\text{A}$ , $V_{GS} = -4.5\text{V}$ , $R_{GEN} = 50\Omega$		60		ns
$t_f$	Turn-Off Fall Time	$V_{DD} = -5\text{V}$ , $I_D = -0.5\text{A}$ , $V_{GS} = -4.5\text{V}$ , $R_{GEN} = 50\Omega$		20		ns

**Note 1.**  $T_A = 25^\circ\text{C}$  unless otherwise noted. Absolute maximum ratings indicate limits beyond which damage to the component may occur. Electrical specifications do not apply when operating the device outside of its operating ratings.

**Note 2.** This device is not guaranteed to operate beyond its specified operating rating.

**Note 3.** Mounted on 1 square-inch pad of 2 oz. copper.

**Note 4.** IC devices are inherently ESD sensitive. Handling precautions required.

**Note 5.** Pulse test; pulse width = 300 $\mu\text{s}$ , duty cycle = 2%.

**Note 6.** Guaranteed by design.

**Note 7.** Body diode current conduction is not recommended.

**Note 8.** Ensure that all drain pins are connected together to optimize  $R_{DS(ON)}$  performance.

# Typical Characteristics

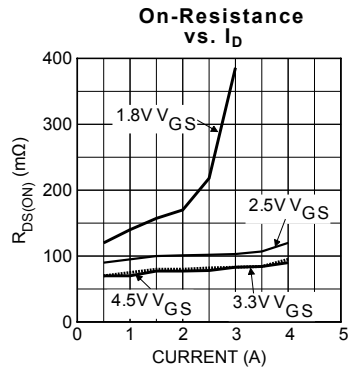
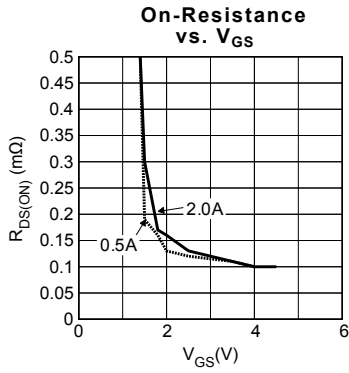
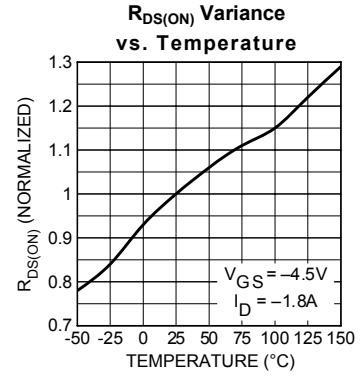
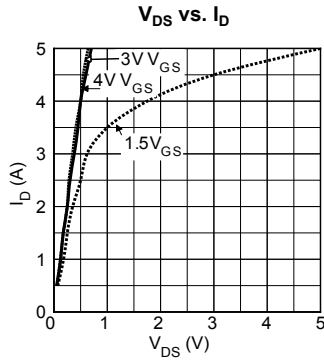
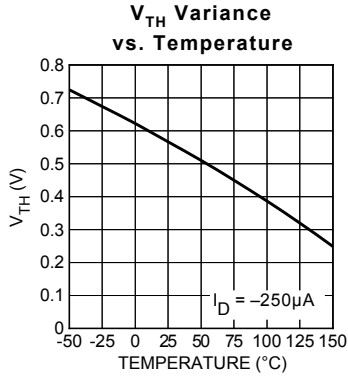

**Package Information**

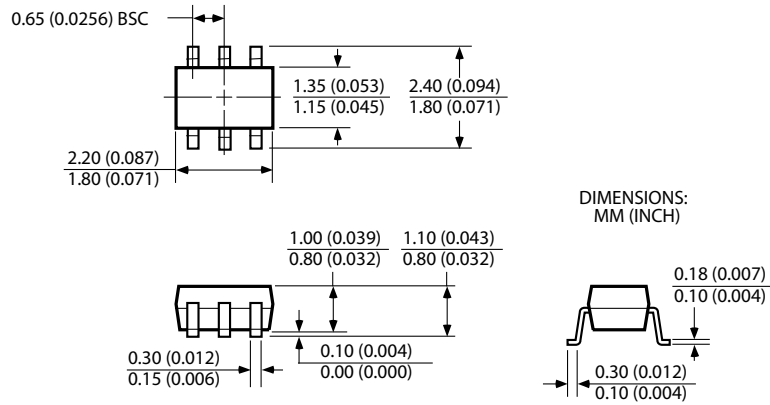

**SC-70-6 Pin (C6)**

**MICREL INC. 2180 FORTUNE DRIVE SAN JOSE, CA 95131 USA**  
 TEL + 1 (408) 944-0800 FAX + 1 (408) 474-1000 WEB <http://www.micrel.com>

This information furnished by

Micrel reserves the right to change circuitry and specifications at any time without notification to the customer.

Micrel Products are not

reasonably be expected to result in personal injury. Life support devices or systems are devices or systems that (a) are intended for surgical implant into the body or (b) support or sustain life, and whose failure to perform can be reasonably expected to result in a significant injury to the user. A Purchaser's use or sale of Micrel Pr

Micrel for any damages resulting from such use or sale.

© 2002 Micrel Incorporated

## Looking for pricing, stock, or lifecycle information?

Click below to explore more details on WIN SOURCE:

- ⊖ [View MIC94052YC6-TR on WIN SOURCE](#)
- ⊖ [Microchip Technology Information](#)

## Optimize Your Supply Chain with WIN SOURCE Solutions

- ✓ Global Sourcing Solution
- ✓ Obsolete Management
- ✓ Cost Control Management
- ✓ Shortage Management
- ✓ Alternative Solution
- ✓ Excess Inventory Management