



THE DATASHEET OF MJE181G



MJE170G, MJE171G, MJE172G (PNP), MJE180G, MJE181G, MJE182G (NPN)

Complementary Plastic Silicon Power Transistors

The MJE170/180 series is designed for low power audio amplifier and low current, high speed switching applications.

Features

- High DC Current Gain
- High Current–Gain – Bandwidth Product
- Annular Construction for Low Leakages
- Epoxy Meets UL 94 V–0 @ 0.125 in
- These Devices are Pb–Free and are RoHS Compliant*

MAXIMUM RATINGS

Rating	Symbol	Value	Unit
Collector–Base Voltage MJE170G, MJE180G MJE171G, MJE181G MJE172G, MJE182G	V_{CB}	60 80 100	Vdc
Collector–Emitter Voltage MJE170G, MJE180G MJE171G, MJE181G MJE172G, MJE182G	V_{CEO}	40 60 80	Vdc
Emitter–Base Voltage	V_{EB}	7.0	Vdc
Collector Current – Continuous	I_C	3.0	Adc
Collector Current – Peak	I_{CM}	6.0	Adc
Base Current	I_B	1.0	Adc
Total Power Dissipation @ $T_C = 25^\circ\text{C}$ Derate above 25°C	P_D	12.5 0.012	W W/ $^\circ\text{C}$
Total Power Dissipation @ $T_A = 25^\circ\text{C}$ Derate above 25°C	P_D	1.5 0.1	W W/ $^\circ\text{C}$
Operating and Storage Junction Temperature Range	T_J, T_{stg}	–65 to +150	$^\circ\text{C}$
ESD – Human Body Model	HBM	3B	V
ESD – Machine Model	MM	C	V

Stresses exceeding those listed in the Maximum Ratings table may damage the device. If any of these limits are exceeded, device functionality should not be assumed, damage may occur and reliability may be affected.

*For additional information on our Pb–Free strategy and soldering details, please download the ON Semiconductor Soldering and Mounting Techniques Reference Manual, SOLDERRM/D.



ON Semiconductor®

<http://onsemi.com>

**3 AMPERES
POWER TRANSISTORS
COMPLEMENTARY SILICON
40 – 60 – 80 VOLTS
12.5 WATTS**

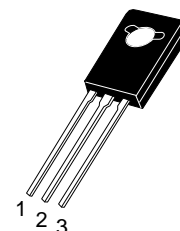
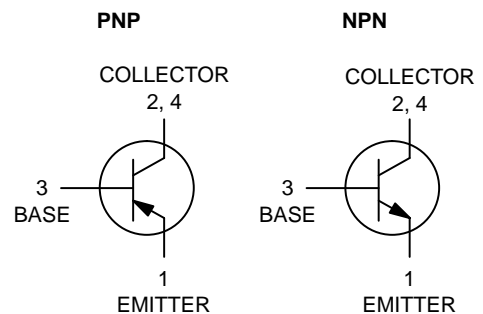

TO-225
CASE 77-09
STYLE 1

MARKING DIAGRAM

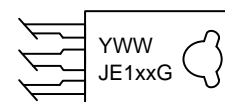

- Y = Year
- WW = Work Week
- JE1xx = Specific Device Code
x = 70, 71, 72, 80, 81, or 82
- G = Pb–Free Package

ORDERING INFORMATION

See detailed ordering and shipping information in the package dimensions section on page 5 of this data sheet.

MJE170G, MJE171G, MJE172G (PNP), MJE180G, MJE181G, MJE182G (NPN)

THERMAL CHARACTERISTICS

Characteristic	Symbol	Max	Unit
Thermal Resistance, Junction-to-Case	$R_{\theta JC}$	10	$^{\circ}C/W$
Thermal Resistance, Junction-to-Ambient	$R_{\theta JA}$	83.4	$^{\circ}C/W$

ELECTRICAL CHARACTERISTICS ($T_C = 25^{\circ}C$ unless otherwise noted)

Characteristic	Symbol	Min	Max	Unit
----------------	--------	-----	-----	------

OFF CHARACTERISTICS

Collector-Emitter Sustaining Voltage ($I_C = 10 \text{ mAdc}$, $I_B = 0$) MJE170G, MJE180G MJE171G, MJE181G MJE172G, MJE182G	$V_{CEO(sus)}$	40 60 80	- - -	Vdc
Collector Cutoff Current ($V_{CB} = 60 \text{ Vdc}$, $I_E = 0$) MJE170G, MJE180G ($V_{CB} = 80 \text{ Vdc}$, $I_E = 0$) MJE171G, MJE181G ($V_{CB} = 100 \text{ Vdc}$, $I_E = 0$) MJE172G, MJE182G ($V_{CB} = 60 \text{ Vdc}$, $I_E = 0$, $T_C = 150^{\circ}C$) MJE170G, MJE180G ($V_{CB} = 80 \text{ Vdc}$, $I_E = 0$, $T_C = 150^{\circ}C$) MJE171G, MJE181G ($V_{CB} = 100 \text{ Vdc}$, $I_E = 0$, $T_C = 150^{\circ}C$) MJE172G, MJE182G	I_{CBO}	- - - -	0.1 0.1 0.1	μAdc mAdc
Emitter Cutoff Current ($V_{BE} = 7.0 \text{ Vdc}$, $I_C = 0$)	I_{EBO}	-	0.1	μAdc

ON CHARACTERISTICS

DC Current Gain ($I_C = 100 \text{ mAdc}$, $V_{CE} = 1.0 \text{ Vdc}$) ($I_C = 500 \text{ mAdc}$, $V_{CE} = 1.0 \text{ Vdc}$) ($I_C = 1.5 \text{ Adc}$, $V_{CE} = 1.0 \text{ Vdc}$)	h_{FE}	50 30 12	250 - -	-
Collector-Emitter Saturation Voltage ($I_C = 500 \text{ mAdc}$, $I_B = 50 \text{ mAdc}$) ($I_C = 1.5 \text{ Adc}$, $I_B = 150 \text{ mAdc}$) ($I_C = 3.0 \text{ Adc}$, $I_B = 600 \text{ mAdc}$)	$V_{CE(sat)}$	- - -	0.3 0.9 1.7	Vdc
Base-Emitter Saturation Voltage ($I_C = 1.5 \text{ Adc}$, $I_B = 150 \text{ mAdc}$) ($I_C = 3.0 \text{ Adc}$, $I_B = 600 \text{ mAdc}$)	$V_{BE(sat)}$	- -	1.5 2.0	Vdc
Base-Emitter On Voltage ($I_C = 500 \text{ mAdc}$, $V_{CE} = 1.0 \text{ Vdc}$)	$V_{BE(on)}$	-	1.2	Vdc

DYNAMIC CHARACTERISTICS

Current-Gain - Bandwidth Product (Note 1) ($I_C = 100 \text{ mAdc}$, $V_{CE} = 10 \text{ Vdc}$, $f_{test} = 10 \text{ MHz}$)	f_T	50	-	MHz
Output Capacitance ($V_{CB} = 10 \text{ Vdc}$, $I_E = 0$, $f = 0.1 \text{ MHz}$) MJE171G/MJE172G MJE181G/MJE182G	C_{ob}	- -	60 40	pF

Product parametric performance is indicated in the Electrical Characteristics for the listed test conditions, unless otherwise noted. Product performance may not be indicated by the Electrical Characteristics if operated under different conditions.

1. $f_T = |h_{fe}| \cdot f_{test}$

MJE170G, MJE171G, MJE172G (PNP), MJE180G, MJE181G, MJE182G (NPN)

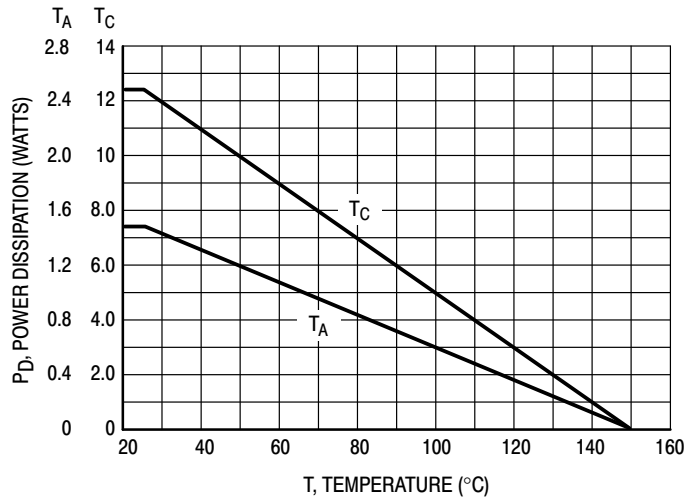

Figure 1. Power Derating

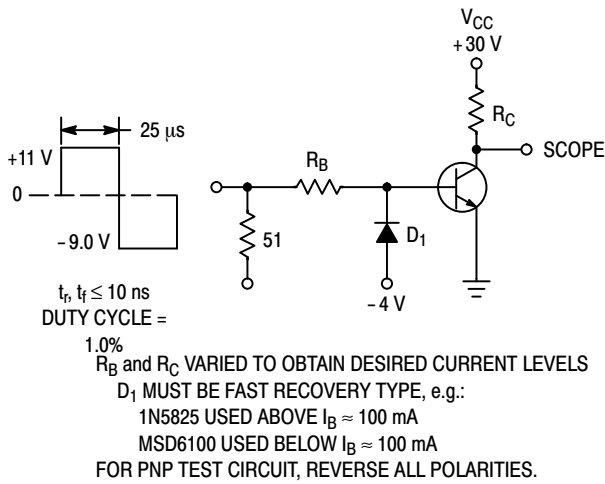

Figure 2. Switching Time Test Circuit

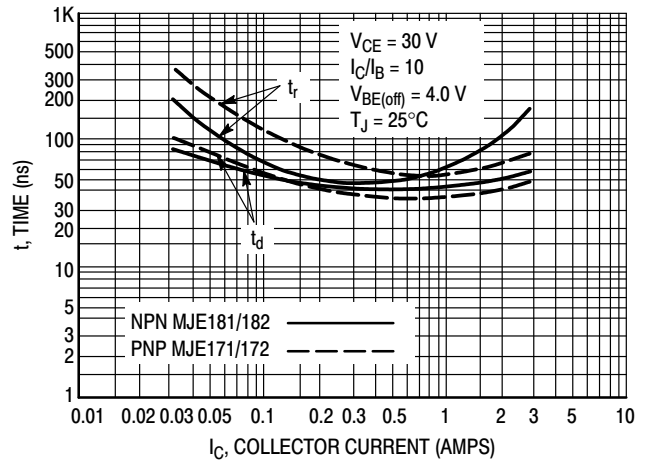

Figure 3. Turn-On Time

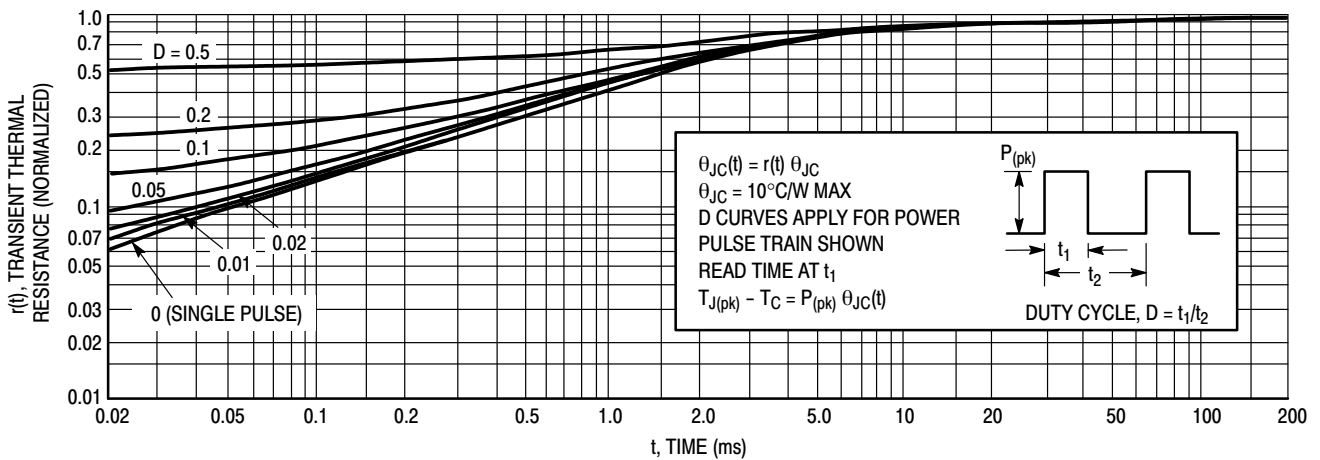

Figure 4. Thermal Response

MJE170G, MJE171G, MJE172G (PNP), MJE180G, MJE181G, MJE182G (NPN)

ACTIVE-REGION SAFE OPERATING AREA

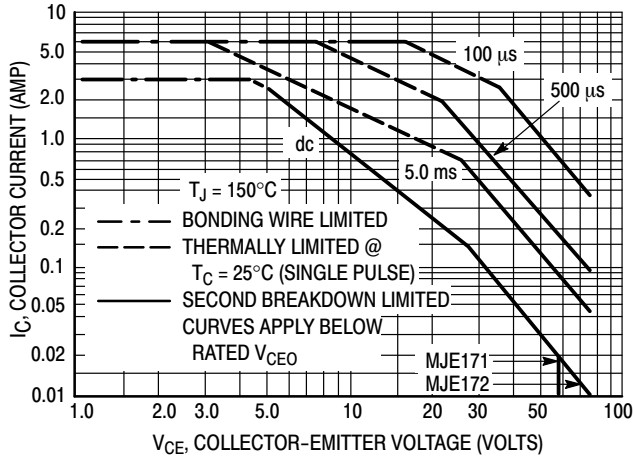

Figure 5. MJE171, MJE172

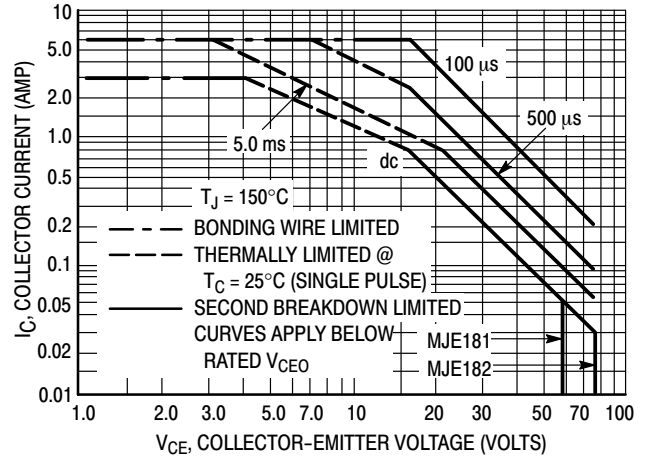

Figure 6. MJE181, MJE182

There are two limitations on the power handling ability of a transistor – average junction temperature and second breakdown. Safe operating area curves indicate $I_C - V_{CE}$ limits of the transistor that must be observed for reliable operation; i.e., the transistor must not be subjected to greater dissipation than the curves indicate.

The data of Figures 5 and 6 is based on $T_{J(pk)} = 150^\circ\text{C}$; T_C is variable depending on conditions. Second breakdown pulse limits are valid for duty cycles to 10% provided $T_{J(pk)} < 150^\circ\text{C}$. $T_{J(pk)}$ may be calculated from the data in Figure 4. At high case temperature, thermal limitations will reduce the power that can be handled to values less than the limitations imposed by second breakdown.

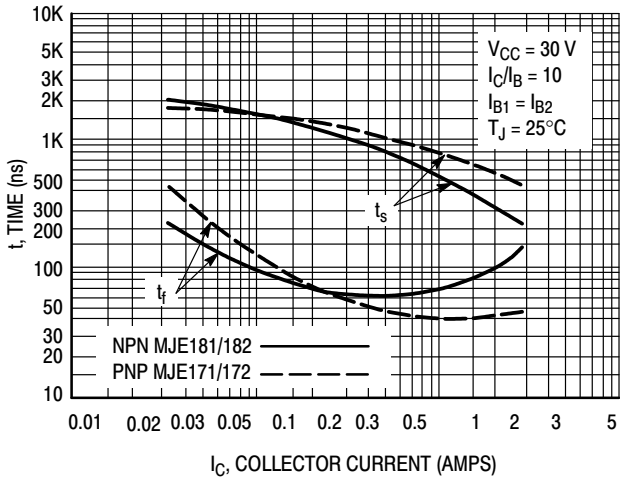

Figure 7. Turn-Off Time

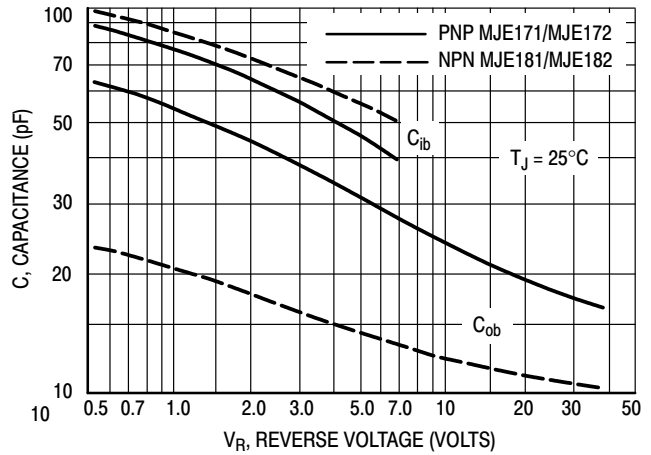

Figure 8. Capacitance

MJE170G, MJE171G, MJE172G (PNP), MJE180G, MJE181G, MJE182G (NPN)

ORDERING INFORMATION

Device	Package	Shipping
MJE170G	TO-225 (Pb-Free)	500 Units / Box
MJE171G	TO-225 (Pb-Free)	500 Units / Box
MJE172G	TO-225 (Pb-Free)	500 Units / Box
MJE180G	TO-225 (Pb-Free)	500 Units / Box
MJE181G	TO-225 (Pb-Free)	500 Units / Box
MJE182G	TO-225 (Pb-Free)	500 Units / Box

MJE170G, MJE171G, MJE172G (PNP), MJE180G, MJE181G, MJE182G (NPN)

PACKAGE DIMENSIONS

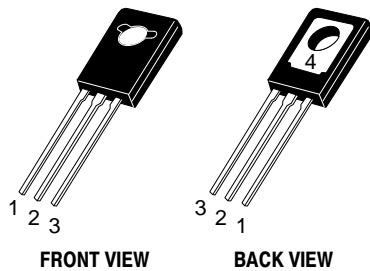

TO-225
CASE 77-09
ISSUE AC

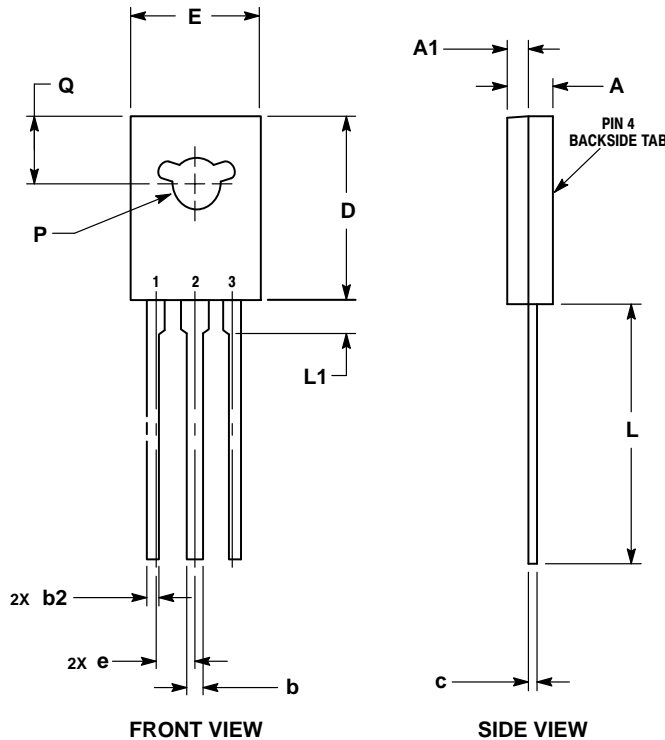

NOTES:

1. DIMENSIONING AND TOLERANCING PER ASME Y14.5M, 1994.
2. CONTROLLING DIMENSION: MILLIMETERS.
3. NUMBER AND SHAPE OF LUGS OPTIONAL.

DIM	MILLIMETERS	
	MIN	MAX
A	2.40	3.00
A1	1.00	1.50
b	0.60	0.90
b2	0.51	0.88
c	0.39	0.63
D	10.60	11.10
E	7.40	7.80
e	2.04	2.54
L	14.50	16.63
L1	1.27	2.54
P	2.90	3.30
Q	3.80	4.20

STYLE 1:

- PIN 1. EMITTER
2., 4. COLLECTOR
3. BASE

ON Semiconductor and are registered trademarks of Semiconductor Components Industries, LLC (SCILLC). SCILLC owns the rights to a number of patents, trademarks, copyrights, trade secrets, and other intellectual property. A listing of SCILLC's product/patent coverage may be accessed at www.onsemi.com/site/pdf/Patent-Marking.pdf. SCILLC reserves the right to make changes without further notice to any products herein. SCILLC makes no warranty, representation or guarantee regarding the suitability of its products for any particular purpose, nor does SCILLC assume any liability arising out of the application or use of any product or circuit, and specifically disclaims any and all liability, including without limitation special, consequential or incidental damages. "Typical" parameters which may be provided in SCILLC data sheets and/or specifications can and do vary in different applications and actual performance may vary over time. All operating parameters, including "Typicals" must be validated for each customer application by customer's technical experts. SCILLC does not convey any license under its patent rights nor the rights of others. SCILLC products are not designed, intended, or authorized for use as components in systems intended for surgical implant into the body, or other applications intended to support or sustain life, or for any other application in which the failure of the SCILLC product could create a situation where personal injury or death may occur. Should Buyer purchase or use SCILLC products for any such unintended or unauthorized application, Buyer shall indemnify and hold SCILLC and its officers, employees, subsidiaries, affiliates, and distributors harmless against all claims, costs, damages, and expenses, and reasonable attorney fees arising out of, directly or indirectly, any claim of personal injury or death associated with such unintended or unauthorized use, even if such claim alleges that SCILLC was negligent regarding the design or manufacture of the part. SCILLC is an Equal Opportunity/Affirmative Action Employer. This literature is subject to all applicable copyright laws and is not for resale in any manner.

PUBLICATION ORDERING INFORMATION

LITERATURE FULFILLMENT:

Literature Distribution Center for ON Semiconductor
P.O. Box 5163, Denver, Colorado 80217 USA
Phone: 303-675-2175 or 800-344-3860 Toll Free USA/Canada
Fax: 303-675-2176 or 800-344-3867 Toll Free USA/Canada
Email: orderlit@onsemi.com

N. American Technical Support: 800-282-9855 Toll Free
USA/Canada
Europe, Middle East and Africa Technical Support:
Phone: 421 33 790 2910
Japan Customer Focus Center
Phone: 81-3-5817-1050



ON Semiconductor Website: www.onsemi.com

Order Literature: <http://www.onsemi.com/orderlit>

For additional information, please contact your local Sales Representative

Looking for pricing, stock, or lifecycle information?

Click below to explore more details on WIN SOURCE:

-  [View MJE181G on WIN SOURCE](#)
-  [ON Semiconductor Information](#)

Optimize Your Supply Chain with WIN SOURCE Solutions

-  Global Sourcing Solution
-  Obsolete Management
-  Cost Control Management
-  Shortage Management
-  Alternative Solution
-  Excess Inventory Management