



**THE DATASHEET OF
MLF1005DR22KT**



SMD Inductors(Coils) For Signal Line(Multilayer, Magnetic Shielded)

Conformity to RoHS Directive

MLF Series MLF1005

Various kinds of digital equipment are becoming smaller with more advanced functions. Therefore, parts used in such digital equipment need to be small and thinner.

MLF1005 Series inductors were developed to meet these demands. This series of inductors have 75% less mass than conventional MLF1608 inductors and are magnetically sealed just like conventional inductors, making high-density mounting possible.

FEATURES

- 75% less mass than the MLF1608 series.
- Magnetically sealed configuration allowing for high-density mounting.
- Does not contain lead and is compatible with lead-free soldering.
- It is a product conforming to RoHS directive.

APPLICATIONS

Signal processing modules such as mobile phones and tuners

SPECIFICATIONS

Operating temperature range	-40 to +85°C
Storage temperature range	-40 to +85°C

RECOMMENDED SOLDERING CONDITION REFLOW SOLDERING

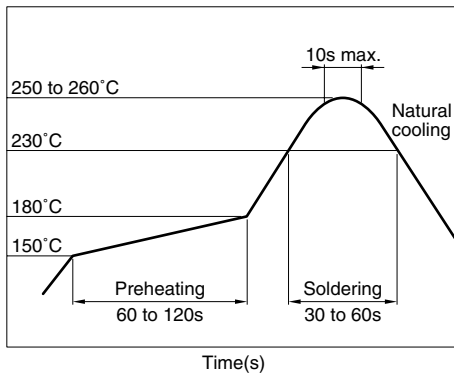

PRODUCT IDENTIFICATION

MLF	1005	DR10	K	T
(1)	(2)	(3)	(4)	(5)

(1) Series name

(2) Dimensions L×W

1005	1.0×0.5×0.5
------	-------------

(3) Material code

(4) Inductance value

R10	0.1μH
1R0	1.0μH

(5) Inductance tolerance

K	±10%
---	------

(6) Packaging style

T	Taping [reel]
---	---------------

PACKAGING STYLE AND QUANTITIES

Packaging style	Quantity
Taping	10000 pieces/reel

HANDLING AND PRECAUTIONS

- Before soldering, be sure to preheat components. The preheating temperature should be set so that the temperature difference between the solder temperature and product temperature does not exceed 150°C.
- After mounting components onto the printed circuit board, do not apply stress through board bending or mishandling.
- The inductance value may change due to magnetic saturation if the current exceeds the rated maximum.
- Do not expose the inductors to stray magnetic fields.
- Avoid static electricity discharge during handling.
- When hand soldering, apply the soldering iron to the printed circuit board only. Temperature of the iron tip should not exceed 350°C. Soldering time should not exceed 3 seconds.

• Conformity to RoHS Directive: This means that, in conformity with EU Directive 2002/95/EC, lead, cadmium, mercury, hexavalent chromium, and specific bromine-based flame retardants, PBB and PBDE, have not been used, except for exempted applications.

• Please contact our Sales office when your application are considered the following:
The device's failure or malfunction may directly endanger human life (e.g. application for automobile/aircraft/medical/nuclear power devices, etc.)

• All specifications are subject to change without notice.

SHAPES AND DIMENSIONS/RECOMMENDED PC BOARD PATTERN

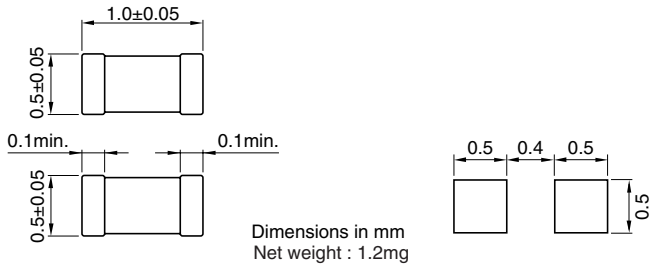

ELECTRICAL CHARACTERISTICS

Part No.	Inductance (μH)	Inductance tolerance	Test frequency L, Q (MHz)	Test current L, Q (mA)	Q min.	Self-resonant frequency (MHz)min.	DC resistance (Ω)max.	Rated current (mA)max.
MLF1005DR10K	0.1	±10%	25	1.0	10	450	0.60	25
MLF1005DR12K	0.12	±10%	25	1.0	10	400	0.70	25
MLF1005DR15K	0.15	±10%	25	1.0	10	350	0.80	25
MLF1005DR18K	0.18	±10%	25	1.0	10	320	0.90	25
MLF1005DR22K	0.22	±10%	25	1.0	10	290	1.10	25
MLF1005DR27K	0.27	±10%	25	1.0	10	260	1.30	25
MLF1005DR33K	0.33	±10%	25	1.0	10	230	1.50	25
MLF1005AR39K	0.39	±10%	10	1.0	25	210	0.60	10
MLF1005AR47K	0.47	±10%	10	1.0	25	190	0.65	10
MLF1005AR56K	0.56	±10%	10	1.0	25	170	0.70	10
MLF1005AR68K	0.68	±10%	10	1.0	25	150	0.80	10
MLF1005AR82K	0.82	±10%	10	1.0	25	130	0.90	10
MLF1005A1R0K	1.0	±10%	10	1.0	25	120	1.00	10
MLF1005A1R2K	1.2	±10%	10	1.0	25	110	1.10	10
MLF1005A1R5K	1.5	±10%	10	1.0	25	100	1.30	10
MLF1005A1R8K	1.8	±10%	10	1.0	25	90	1.55	10
MLF1005A2R2K	2.2	±10%	10	1.0	25	80	1.80	10

· Test equipment(L, Q): Ag-4294A or equivalent
 Test tool: Ag-16034G or equivalent

TYPICAL ELECTRICAL CHARACTERISTICS

INDUCTANCE vs. FREQUENCY CHARACTERISTICS

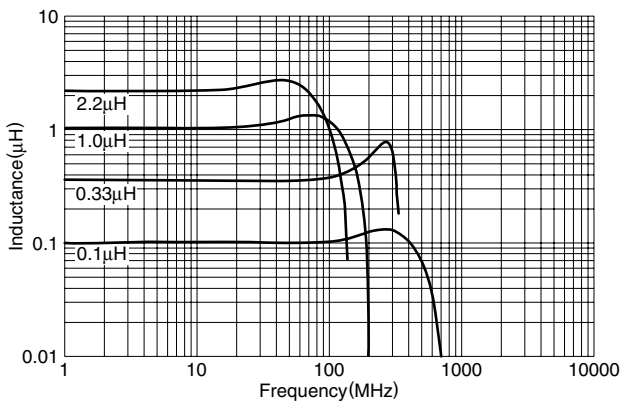

Q vs. FREQUENCY CHARACTERISTICS

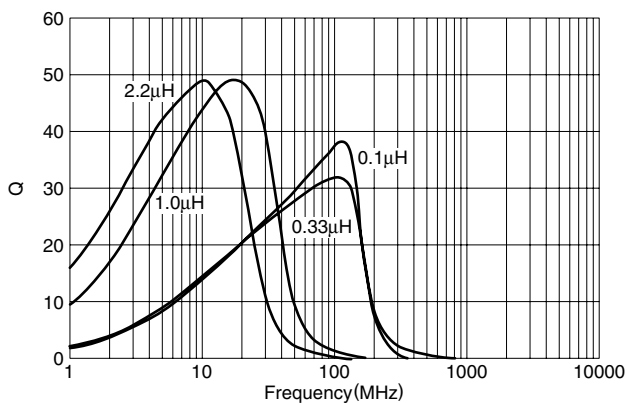

IMPEDANCE vs. FREQUENCY CHARACTERISTICS

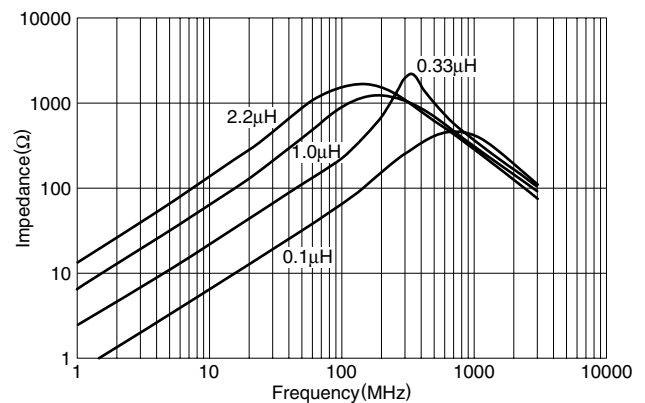

· All specifications are subject to change without notice.

PACKAGING STYLES

REEL DIMENSIONS

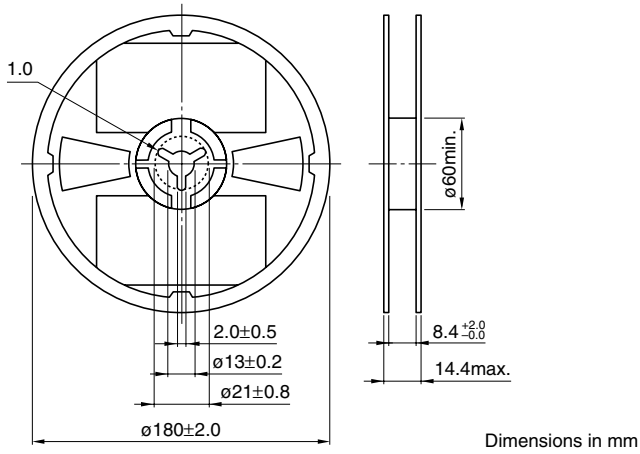

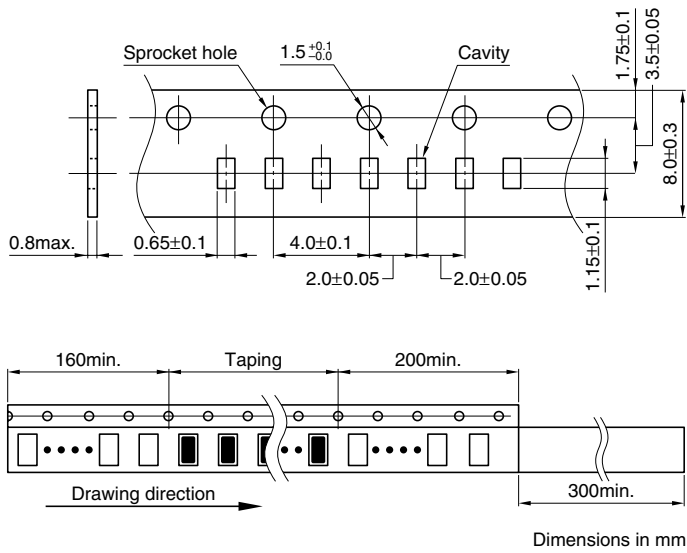

TAPE DIMENSIONS



• All specifications are subject to change without notice.

Looking for pricing, stock, or lifecycle information?

Click below to explore more details on WIN SOURCE:

-  [View MLF1005DR22KT on WIN SOURCE](#)
-  [TDK Corporation Information](#)

Optimize Your Supply Chain with WIN SOURCE Solutions

-  Global Sourcing Solution
-  Obsolete Management
-  Cost Control Management
-  Shortage Management
-  Alternative Solution
-  Excess Inventory Management