



**THE DATASHEET OF  
MLF2012DR47JTD25**



## Inductors for standard circuits

## Multilayer ferrite

## MLF series (for automotive)



AEC-Q200

## MLF2012 type



## FEATURES

- The lineup includes a wide inductance range.
- Highly reliable monolithic structure with multilayer integration.
- Operating temperature range: -55 to +125°C

## APPLICATION

- Automotive equipment, smart phones, tablet terminals, tuners, LCD-TVs, PDP-TVs, audio equipment, computers, signal processing for modules etc.

## PART NUMBER CONSTRUCTION

MLF	2012	D	47N	△	T	D25
Series name	LxWxH dimensions 2.0x1.25x0.85 mm 2.0x1.25x1.25 mm	Characteristics	Inductance (μH)	Inductance tolerance	Packaging style	Internal code

\* The " △ " of the Part Number contains the inductance tolerance code, J (±5%), K (±10%), or M (±20%).

## CHARACTERISTICS SPECIFICATION TABLE

L (μH)	Q Tolerance	Q		L, Q measuring conditions		Self-resonant frequency		DC resistance		Rated current (mA)max.	Thickness (mm)	Part No.*
		min.	typ.	Frequency (MHz)	Current (mA)	(MHz)min.	(MHz)typ.	(Ω)max.	(Ω)typ.			
0.047	±20%	15	25	50	1.0	550	700	0.10	0.05	300	0.85	<a href="#">MLF2012D47NMTD25</a>
0.068	±20%	15	25	50	1.0	500	600	0.15	0.08	300	0.85	<a href="#">MLF2012D68NMTD25</a>
0.082	±20%	15	25	50	1.0	450	550	0.15	0.08	300	0.85	<a href="#">MLF2012D82NMTD25</a>
0.10	±5%	20	30	25	1.0	400	500	0.15	0.10	300	0.85	<a href="#">MLF2012DR10JTD25</a>
	<a href="#">MLF2012DR10KTD25</a>											
	<a href="#">MLF2012DR10MTD25</a>											
0.12	±5%	20	30	25	1.0	360	450	0.20	0.12	300	0.85	<a href="#">MLF2012DR12JTD25</a>
	<a href="#">MLF2012DR12KTD25</a>											
	<a href="#">MLF2012DR12MTD25</a>											
0.15	±5%	20	30	25	1.0	320	410	0.20	0.13	300	0.85	<a href="#">MLF2012DR15JTD25</a>
	<a href="#">MLF2012DR15KTD25</a>											
	<a href="#">MLF2012DR15MTD25</a>											
0.18	±5%	20	30	25	1.0	280	370	0.25	0.15	300	0.85	<a href="#">MLF2012DR18JTD25</a>
	<a href="#">MLF2012DR18KTD25</a>											
	<a href="#">MLF2012DR18MTD25</a>											
0.22	±5%	20	30	25	1.0	250	330	0.30	0.16	250	0.85	<a href="#">MLF2012DR22JTD25</a>
	<a href="#">MLF2012DR22KTD25</a>											
	<a href="#">MLF2012DR22MTD25</a>											
0.27	±5%	20	30	25	1.0	220	300	0.35	0.18	250	0.85	<a href="#">MLF2012DR27JTD25</a>
	<a href="#">MLF2012DR27KTD25</a>											
	<a href="#">MLF2012DR27MTD25</a>											

## Measurement equipment

Measurement item	Product No.	Manufacturer
L, Q	4294A+16034G	Keysight Technologies
Self-resonant frequency	E4991A	Keysight Technologies
DC resistance	Type-7561	Yokogawa

\* Equivalent measurement equipment may be used.

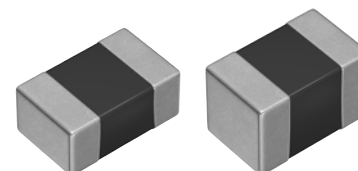

⚠ Please be sure to request delivery specifications that provide further details on the features and specifications of the products for proper and safe use. (1/9)  
Please note that the contents may change without any prior notice due to reasons such as upgrading.

20190205

inductor\_automotive\_standard\_mlf2012\_en

## MLF2012 type

## CHARACTERISTICS SPECIFICATION TABLE

L	Q	L, Q measuring conditions			Self-resonant frequency		DC resistance		Rated current	Thickness	Part No.*	
		min.	typ.	Frequency (MHz)	Current (mA)	(MHz)min.	(MHz)typ.	( $\Omega$ )max.				( $\Omega$ )typ.
( $\mu$ H)	Tolerance								(mA)max.	(mm)		
0.33	$\pm 5\%$	20	30	25	1.0	200	270	0.40	0.23	250	0.85	<a href="#">MLF2012DR33JTD25</a>
	$\pm 10\%$											<a href="#">MLF2012DR33KTD25</a>
	$\pm 20\%$											<a href="#">MLF2012DR33MTD25</a>
0.39	$\pm 5\%$	25	35	25	1.0	180	250	0.45	0.25	200	0.85	<a href="#">MLF2012DR39JTD25</a>
	$\pm 10\%$											<a href="#">MLF2012DR39KTD25</a>
	$\pm 20\%$											<a href="#">MLF2012DR39MTD25</a>
0.47	$\pm 5\%$	25	35	25	1.0	160	230	0.50	0.25	200	1.25	<a href="#">MLF2012DR47JTD25</a>
	$\pm 10\%$											<a href="#">MLF2012DR47KTD25</a>
	$\pm 20\%$											<a href="#">MLF2012DR47MTD25</a>
0.56	$\pm 5\%$	25	35	25	1.0	150	210	0.55	0.30	150	1.25	<a href="#">MLF2012DR56JTD25</a>
	$\pm 10\%$											<a href="#">MLF2012DR56KTD25</a>
	$\pm 20\%$											<a href="#">MLF2012DR56MTD25</a>
0.68	$\pm 5\%$	25	35	25	1.0	140	190	0.60	0.35	150	1.25	<a href="#">MLF2012DR68JTD25</a>
	$\pm 10\%$											<a href="#">MLF2012DR68KTD25</a>
	$\pm 20\%$											<a href="#">MLF2012DR68MTD25</a>
0.82	$\pm 5\%$	25	35	25	1.0	130	170	0.65	0.40	150	1.25	<a href="#">MLF2012DR82JTD25</a>
	$\pm 10\%$											<a href="#">MLF2012DR82KTD25</a>
	$\pm 20\%$											<a href="#">MLF2012DR82MTD25</a>
1.0	$\pm 5\%$	45	55	10	1.0	120	160	0.30	0.15	80	0.85	<a href="#">MLF2012A1R0JTD25</a>
	$\pm 10\%$											<a href="#">MLF2012A1R0KTD25</a>
	$\pm 20\%$											<a href="#">MLF2012A1R0MTD25</a>
1.2	$\pm 5\%$	45	55	10	1.0	110	150	0.35	0.15	80	0.85	<a href="#">MLF2012A1R2JTD25</a>
	$\pm 10\%$											<a href="#">MLF2012A1R2KTD25</a>
	$\pm 20\%$											<a href="#">MLF2012A1R2MTD25</a>
1.5	$\pm 5\%$	45	60	10	1.0	100	140	0.40	0.18	80	0.85	<a href="#">MLF2012A1R5JTD25</a>
	$\pm 10\%$											<a href="#">MLF2012A1R5KTD25</a>
	$\pm 20\%$											<a href="#">MLF2012A1R5MTD25</a>
1.8	$\pm 5\%$	45	60	10	1.0	90	130	0.45	0.20	80	0.85	<a href="#">MLF2012A1R8JTD25</a>
	$\pm 10\%$											<a href="#">MLF2012A1R8KTD25</a>
	$\pm 20\%$											<a href="#">MLF2012A1R8MTD25</a>
2.2	$\pm 5\%$	45	60	10	1.0	80	120	0.50	0.22	50	0.85	<a href="#">MLF2012A2R2JTD25</a>
	$\pm 10\%$											<a href="#">MLF2012A2R2KTD25</a>
	$\pm 20\%$											<a href="#">MLF2012A2R2MTD25</a>
2.7	$\pm 5\%$	45	70	10	1.0	70	100	0.55	0.25	50	1.25	<a href="#">MLF2012A2R7JTD25</a>
	$\pm 10\%$											<a href="#">MLF2012A2R7KTD25</a>
	$\pm 20\%$											<a href="#">MLF2012A2R7MTD25</a>
3.3	$\pm 5\%$	45	70	10	1.0	60	90	0.60	0.28	50	1.25	<a href="#">MLF2012A3R3JTD25</a>
	$\pm 10\%$											<a href="#">MLF2012A3R3KTD25</a>
	$\pm 20\%$											<a href="#">MLF2012A3R3MTD25</a>
3.9	$\pm 5\%$	45	70	10	1.0	55	80	0.65	0.30	30	1.25	<a href="#">MLF2012A3R9JTD25</a>
	$\pm 10\%$											<a href="#">MLF2012A3R9KTD25</a>
	$\pm 20\%$											<a href="#">MLF2012A3R9MTD25</a>
4.7	$\pm 5\%$	45	70	10	1.0	50	70	0.70	0.35	30	1.25	<a href="#">MLF2012A4R7JTD25</a>
	$\pm 10\%$											<a href="#">MLF2012A4R7KTD25</a>
	$\pm 20\%$											<a href="#">MLF2012A4R7MTD25</a>
5.6	$\pm 5\%$	50	75	4	0.1	45	65	0.60	0.30	15	1.25	<a href="#">MLF2012E5R6JTD25</a>
	$\pm 10\%$											<a href="#">MLF2012E5R6KTD25</a>
	$\pm 20\%$											<a href="#">MLF2012E5R6MTD25</a>
6.8	$\pm 5\%$	50	75	4	0.1	40	60	0.65	0.32	15	1.25	<a href="#">MLF2012E6R8JTD25</a>
	$\pm 10\%$											<a href="#">MLF2012E6R8KTD25</a>
	$\pm 20\%$											<a href="#">MLF2012E6R8MTD25</a>
8.2	$\pm 5\%$	50	75	4	0.1	35	55	0.70	0.35	15	1.25	<a href="#">MLF2012E8R2JTD25</a>
	$\pm 10\%$											<a href="#">MLF2012E8R2KTD25</a>
	$\pm 20\%$											<a href="#">MLF2012E8R2MTD25</a>

## Measurement equipment

Measurement item	Product No.	Manufacturer
L, Q	4294A+16034G	Keysight Technologies
Self-resonant frequency	E4991A	Keysight Technologies
DC resistance	Type-7561	Yokogawa

\* Equivalent measurement equipment may be used.

## MLF2012 type

## CHARACTERISTICS SPECIFICATION TABLE

L	Q	L, Q measuring conditions		Self-resonant frequency		DC resistance		Rated current		Thickness	Part No.*	
		Frequency	Current	(MHz)min.	(MHz)typ.	( $\Omega$ )max.	( $\Omega$ )typ.	(mA)max.	(mm)			
10	$\pm 5\%$ $\pm 10\%$ $\pm 20\%$	50	75	2	0.1	30	50	0.80	0.40	15	1.25	<a href="#">MLF2012E100JTD25</a> <a href="#">MLF2012E100KTD25</a> <a href="#">MLF2012E100MTD25</a>
12	$\pm 5\%$ $\pm 10\%$ $\pm 20\%$	50	75	2	0.1	25	45	0.90	0.50	15	1.25	<a href="#">MLF2012E120JTD25</a> <a href="#">MLF2012E120KTD25</a> <a href="#">MLF2012E120MTD25</a>
15	$\pm 10\%$ $\pm 20\%$	30	45	1	0.1	22	40	0.70	0.35	5	1.25	<a href="#">MLF2012C150KTD25</a> <a href="#">MLF2012C150MTD25</a>
18	$\pm 10\%$ $\pm 20\%$	30	45	1	0.1	20	38	0.80	0.38	5	1.25	<a href="#">MLF2012C180KTD25</a> <a href="#">MLF2012C180MTD25</a>
22	$\pm 10\%$ $\pm 20\%$	30	45	1	0.1	18	35	0.90	0.45	5	1.25	<a href="#">MLF2012C220KTD25</a> <a href="#">MLF2012C220MTD25</a>
27	$\pm 10\%$ $\pm 20\%$	30	45	1	0.1	17	33	1.00	0.50	5	1.25	<a href="#">MLF2012C270KTD25</a> <a href="#">MLF2012C270MTD25</a>
33	$\pm 10\%$ $\pm 20\%$	30	45	0.4	0.1	15	28	1.10	0.55	5	1.25	<a href="#">MLF2012C330KTD25</a> <a href="#">MLF2012C330MTD25</a>
39	$\pm 10\%$ $\pm 20\%$	35	55	2	0.1	13	23	2.40	1.30	4	1.25	<a href="#">MLF2012K390KTD25</a> <a href="#">MLF2012K390MTD25</a>
47	$\pm 10\%$ $\pm 20\%$	35	55	2	0.1	11	20	2.70	1.60	4	1.25	<a href="#">MLF2012K470KTD25</a> <a href="#">MLF2012K470MTD25</a>
56	$\pm 10\%$ $\pm 20\%$	35	55	2	0.1	10	18	2.80	1.80	4	1.25	<a href="#">MLF2012K560KTD25</a> <a href="#">MLF2012K560MTD25</a>
68	$\pm 10\%$ $\pm 20\%$	25	45	1	0.1	9	16	2.90	2.00	2	1.25	<a href="#">MLF2012C680KTD25</a> <a href="#">MLF2012C680MTD25</a>
82	$\pm 10\%$ $\pm 20\%$	25	45	1	0.1	8	14	3.00	2.40	2	1.25	<a href="#">MLF2012C820KTD25</a> <a href="#">MLF2012C820MTD25</a>
100	$\pm 10\%$ $\pm 20\%$	25	45	1	0.1	7	12	3.10	2.50	2	1.25	<a href="#">MLF2012C101KTD25</a> <a href="#">MLF2012C101MTD25</a>

## Measurement equipment

Measurement item	Product No.	Manufacturer
L, Q	4294A+16034G	Keysight Technologies
Self-resonant frequency	E4991A	Keysight Technologies
DC resistance	Type-7561	Yokogawa

\* Equivalent measurement equipment may be used.

# MLF2012 type

## L FREQUENCY CHARACTERISTICS



Measurement equipment

Product No.	Manufacturer
E4991A+16192A	Keysight Technologies

\* Equivalent measurement equipment may be used.

# MLF2012 type

## L FREQUENCY CHARACTERISTICS



Measurement equipment

Product No.	Manufacturer
4294A+16034G	Keysight Technologies

\* Equivalent measurement equipment may be used.

# MLF2012 type

## Q FREQUENCY CHARACTERISTICS



Measurement equipment

Product No.	Manufacturer
E4991A+16192A	Keysight Technologies

\* Equivalent measurement equipment may be used.

# MLF2012 type

## Q FREQUENCY CHARACTERISTICS



Measurement equipment

Product No.	Manufacturer
4294A+16034G	Keysight Technologies

\* Equivalent measurement equipment may be used.

# MLF2012 type

## SHAPE & DIMENSIONS

t=0.85mm

t=1.25mm

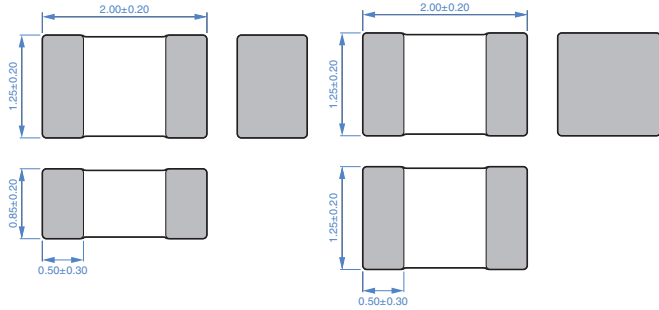

Dimensions in mm

## PACKAGING STYLE

### REEL DIMENSIONS

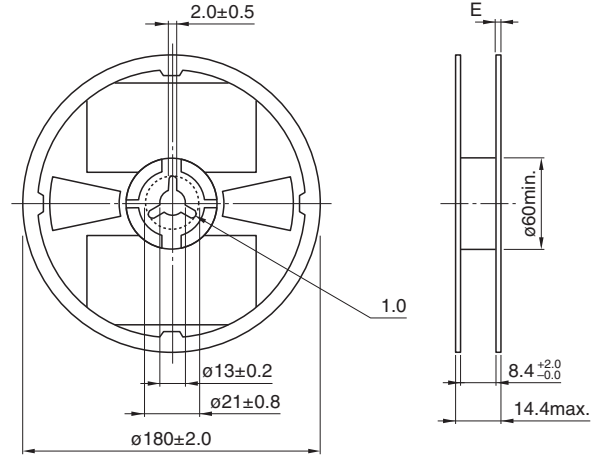

Dimensions in mm

## RECOMMENDED LAND PATTERN

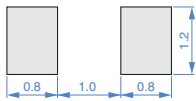

Dimensions in mm

### TAPE DIMENSIONS

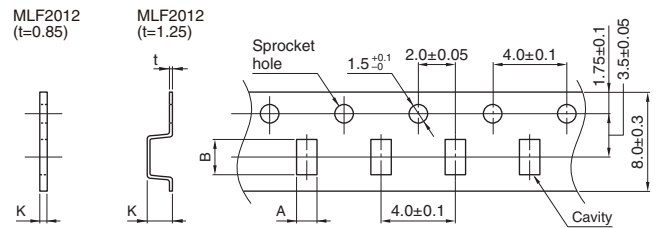

Dimensions in mm

Type	A	B	K	
MLF2012	t=0.85	1.5±0.2	2.3±0.2	1.1 max.
	t=1.25	1.5±0.2	2.3±0.2	1.5 max.

## RECOMMENDED REFLOW PROFILE

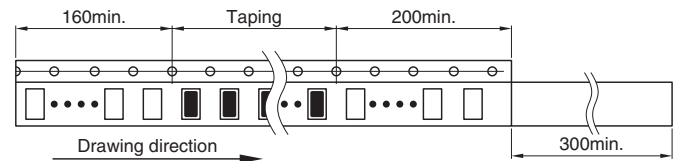
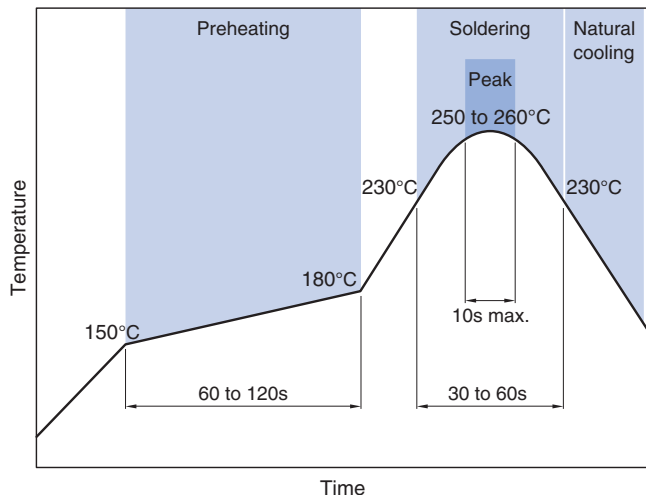

Dimensions in mm

### PACKAGE QUANTITY

Package quantity	t=0.85mm	t=1.25mm
	4000 pcs/reel	2000 pcs/reel

## TEMPERATURE RANGE, INDIVIDUAL WEIGHT

Type	Operating temperature range*	Storage temperature range**	Individual weight
t=0.85mm	-55 to +125 °C	-55 to +125 °C	10 mg
t=1.25mm	-55 to +125 °C	-55 to +125 °C	14 mg

\* In case the product's inductance is 15µH or higher, both operating and storage temperature ranges are -40 to +85°C.

\*\* The storage temperature range is for after the assembly.

## REMINDERS FOR USING THESE PRODUCTS

Before using these products, be sure to request the delivery specifications.

### SAFETY REMINDERS

Please pay sufficient attention to the warnings for safe designing when using this products.

#### REMINDERS

- The storage period is less than 12 months. Be sure to follow the storage conditions (temperature: 5 to 40°C, humidity: 10 to 75% RH or less).  
If the storage period elapses, the soldering of the terminal electrodes may deteriorate.
- Do not use or store in locations where there are conditions such as gas corrosion (salt, acid, alkali, etc.).
- Before soldering, be sure to preheat components.  
The preheating temperature should be set so that the temperature difference between the solder temperature and chip temperature does not exceed 150°C.
- Soldering corrections after mounting should be within the range of the conditions determined in the specifications.  
If overheated, a short circuit, performance deterioration, or lifespan shortening may occur.
- When embedding a printed circuit board where a chip is mounted to a set, be sure that residual stress is not given to the chip due to the overall distortion of the printed circuit board and partial distortion such as at screw tightening portions.
- Self heating (temperature increase) occurs when the power is turned ON, so the tolerance should be sufficient for the set thermal design.
- Carefully lay out the coil for the circuit board design of the non-magnetic shield type.  
A malfunction may occur due to magnetic interference.
- Use a wrist band to discharge static electricity in your body through the grounding wire.
- Do not expose the products to magnets or magnetic fields.
- Do not use for a purpose outside of the contents regulated in the delivery specifications.
- The products listed on this catalog are intended for use in general electronic equipment (AV equipment, telecommunications equipment, home appliances, amusement equipment, computer equipment, personal equipment, office equipment, measurement equipment, industrial robots) under a normal operation and use condition.  
The products are not designed or warranted to meet the requirements of the applications listed below, whose performance and/or quality require a more stringent level of safety or reliability, or whose failure, malfunction or trouble could cause serious damage to society, person or property.  
If you intend to use the products in the applications listed below or if you have special requirements exceeding the range or conditions set forth in the each catalog, please contact us.

- (1) Aerospace/aviation equipment
- (2) Transportation equipment (electric trains, ships, etc.)
- (3) Medical equipment
- (4) Power-generation control equipment
- (5) Atomic energy-related equipment
- (6) Seabed equipment
- (7) Transportation control equipment

- (8) Public information-processing equipment
- (9) Military equipment
- (10) Electric heating apparatus, burning equipment
- (11) Disaster prevention/crime prevention equipment
- (12) Safety equipment
- (13) Other applications that are not considered general-purpose applications

When designing your equipment even for general-purpose applications, you are kindly requested to take into consideration securing protection circuit/device or providing backup circuits in your equipment.

## Looking for pricing, stock, or lifecycle information?

Click below to explore more details on WIN SOURCE:

- ⊖ [View MLF2012DR47JTD25 on WIN SOURCE](#)
- ⊖ [TDK Corporation Information](#)

## Optimize Your Supply Chain with WIN SOURCE Solutions

- ✓ Global Sourcing Solution
- ✓ Obsolete Management
- ✓ Cost Control Management
- ✓ Shortage Management
- ✓ Alternative Solution
- ✓ Excess Inventory Management