



**THE DATASHEET OF
MLK0603L15NJT000**



Inductors for high frequency circuits
Multilayer ceramic
MLK series



MLK0603 type



FEATURES

- With the adoption of a giga-spiral laminated structure, a self-resonant frequency higher than that of the MLG structure can be obtained, while the decrease of Q in the GHz band is limited.
- Monolithic structure is formed using a multilayering and sintering process with ceramic and conductive materials for high-frequency.
- There is no directivity.
- Operating temperature range: -55 to +125°C

APPLICATION

- Smart phones, tablet terminals, high frequency modules (PAs, VCOs, FEMs , etc.), Bluetooth, W-LAN, UWB, tuners and other high frequency circuits for the mobile communication industry
- Application guides: [Smart phones/tablets](#)

PART NUMBER CONSTRUCTION

MLK	0603	L	1N0	S	T	000
Series name	L×W×H dimensions 0.6×0.3×0.3 mm	Characteristics	Inductance (nH)	Inductance tolerance	Packaging style	Internal code

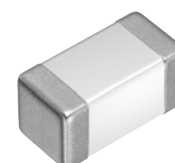

MLK0603 type

CHARACTERISTICS SPECIFICATION TABLE

L (nH)	Tolerance	L measuring frequency (MHz)	Q min.	Q measuring frequency (MHz)	Self-resonant frequency		DC resistance		Rated current (mA)max.	Part No.
					(GHz)min.	(GHz)typ.	(Ω)max.	(Ω)typ.		
1.0	± 0.3 nH	100	6	300	12.0	17.1	0.20	0.09	300	MLK0603L1N0ST000
1.1	± 0.3 nH	100	6	300	11.0	17.1	0.22	0.10	300	MLK0603L1N1ST000
1.2	± 0.3 nH	100	6	300	11.0	16.1	0.22	0.11	300	MLK0603L1N2ST000
1.3	± 0.3 nH	100	6	300	10.0	15.8	0.24	0.12	300	MLK0603L1N3ST000
1.5	± 0.3 nH	100	6	300	10.0	14.9	0.24	0.12	300	MLK0603L1N5ST000
1.6	± 0.3 nH	100	6	300	10.0	14.3	0.27	0.13	300	MLK0603L1N6ST000
1.8	± 0.3 nH	100	6	300	10.0	13.8	0.27	0.14	300	MLK0603L1N8ST000
2.0	± 0.3 nH	100	6	300	9.0	12.6	0.30	0.15	300	MLK0603L2N0ST000
2.2	± 0.3 nH	100	6	300	9.0	12.5	0.30	0.17	300	MLK0603L2N2ST000
2.4	± 0.3 nH	100	6	300	8.5	11.4	0.35	0.17	300	MLK0603L2N4ST000
2.7	± 0.3 nH	100	6	300	8.5	10.9	0.35	0.18	300	MLK0603L2N7ST000
3.0	± 0.3 nH	100	6	300	8.0	10.6	0.40	0.20	200	MLK0603L3N0ST000
3.3	± 0.3 nH	100	6	300	8.0	10.5	0.40	0.22	200	MLK0603L3N3ST000
3.6	± 0.3 nH	100	6	300	8.0	9.9	0.45	0.22	200	MLK0603L3N6ST000
3.9	± 0.3 nH	100	6	300	8.0	9.8	0.45	0.25	200	MLK0603L3N9ST000
4.3	± 0.3 nH	100	6	300	7.5	9.5	0.50	0.28	200	MLK0603L4N3ST000
4.7	± 0.3 nH	100	6	300	7.5	9.5	0.50	0.28	200	MLK0603L4N7ST000
5.1	± 0.3 nH	100	6	300	6.5	8.8	0.60	0.28	200	MLK0603L5N1ST000
5.6	± 0.3 nH	100	6	300	6.5	8.5	0.60	0.30	200	MLK0603L5N6ST000
6.2	± 0.3 nH	100	6	300	6.0	8.3	0.65	0.34	200	MLK0603L6N2ST000
6.8	$\pm 5\%$	100	6	300	6.0	8.1	0.65	0.34	200	MLK0603L6N8JT000
7.5	$\pm 5\%$	100	6	300	6.0	7.7	0.70	0.36	200	MLK0603L7N5JT000
8.2	$\pm 5\%$	100	6	300	6.0	7.9	0.70	0.41	200	MLK0603L8N2JT000
9.1	$\pm 5\%$	100	6	300	5.5	7.4	0.80	0.42	200	MLK0603L9N1JT000
10	$\pm 5\%$	100	6	300	5.5	7.5	0.80	0.48	200	MLK0603L10NJT000
12	$\pm 5\%$	100	6	300	5.0	6.9	1.00	0.54	150	MLK0603L12NJT000
15	$\pm 5\%$	100	6	300	4.5	6.6	1.10	0.66	150	MLK0603L15NJT000
18	$\pm 5\%$	100	6	300	4.0	5.8	1.30	0.85	100	MLK0603L18NJT000
22	$\pm 5\%$	100	6	300	3.5	5.3	1.60	1.02	100	MLK0603L22NJT000
27	$\pm 5\%$	100	6	300	3.0	4.6	1.70	1.09	100	MLK0603L27NJT000
33	$\pm 5\%$	100	6	300	2.8	4.4	1.80	1.21	100	MLK0603L33NJT000

Measurement equipment

Measurement item	Product No.	Manufacturer
L, Q	4291B+16197A	Keysight Technologies
Self-resonant frequency	8720C	Keysight Technologies
DC resistance	Type-7561	Yokogawa

* Equivalent measurement equipment may be used.

MLK0603 type

L, Q FREQUENCY CHARACTERISTICS TABLE

L(nH)typ.		Q typ.					Part No.				
500MHz	800MHz	1.8GHz	2.0GHz	2.4GHz	500MHz	800MHz	1.8GHz	2.0GHz	2.4GHz		
0.9	0.9	0.9	0.9	0.9	10	12	19	20	22	MLK0603L1N0ST000	
1.0	1.0	0.9	0.9	0.9	9	11	17	18	20	MLK0603L1N1ST000	
1.1	1.0	1.0	1.0	1.0	9	12	18	19	21	MLK0603L1N2ST000	
1.2	1.1	1.1	1.1	1.1	9	12	18	19	21	MLK0603L1N3ST000	
1.3	1.3	1.3	1.3	1.3	9	12	18	19	21	MLK0603L1N5ST000	
1.4	1.4	1.4	1.4	1.4	9	12	18	19	21	MLK0603L1N6ST000	
1.6	1.6	1.6	1.6	1.6	9	11	17	18	20	MLK0603L1N8ST000	
1.8	1.7	1.7	1.7	1.7	9	12	17	18	20	MLK0603L2N0ST000	
2.0	1.9	1.9	1.9	2.0	10	12	19	20	22	MLK0603L2N2ST000	
2.1	2.1	2.1	2.1	2.1	9	12	18	19	20	MLK0603L2N4ST000	
2.4	2.4	2.4	2.4	2.4	10	13	19	20	22	MLK0603L2N7ST000	
2.7	2.6	2.6	2.6	2.7	9	12	18	19	21	MLK0603L3N0ST000	
3.0	2.9	2.9	3.0	3.0	10	13	19	20	22	MLK0603L3N3ST000	
3.2	3.1	3.1	3.1	3.2	9	11	17	18	19	MLK0603L3N6ST000	
3.5	3.4	3.5	3.5	3.5	10	13	19	20	22	MLK0603L3N9ST000	
3.8	3.8	3.8	3.8	3.9	10	12	18	19	20	MLK0603L4N3ST000	
4.2	4.2	4.2	4.2	4.3	10	13	19	20	22	MLK0603L4N7ST000	
4.6	4.5	4.5	4.6	4.7	10	12	18	19	21	MLK0603L5N1ST000	
5.0	5.0	5.0	5.0	5.1	10	12	18	19	21	MLK0603L5N6ST000	
5.5	5.5	5.5	5.6	5.7	10	12	18	19	20	MLK0603L6N2ST000	
6.2	6.1	6.2	6.2	6.4	10	13	19	20	22	MLK0603L6N8JT000	
6.7	6.6	6.7	6.8	7.0	10	12	18	19	20	MLK0603L7N5JT000	
7.4	7.3	7.5	7.6	7.8	10	13	19	20	21	MLK0603L8N2JT000	
8.2	8.1	8.3	8.4	8.6	10	12	18	18	20	MLK0603L9N1JT000	
9.0	8.9	9.2	9.3	9.6	10	13	18	19	20	MLK0603L10NJT000	
10.8	10.6	11.0	11.2	11.6	10	12	18	18	20	MLK0603L12NJT000	
13.5	13.4	13.9	14.2	14.8	10	12	17	18	19	MLK0603L15NJT000	
16.2	16.1	17.0	17.4	18.4	10	12	16	17	18	MLK0603L18NJT000	
19.8	19.7	20.9	21.5	22.8	10	12	16	16	17	MLK0603L22NJT000	
24.4	24.4	27.2	28.6	31.7	10	12	15	15	14	MLK0603L27NJT000	
29.7	29.7	33.4	35.1	39.3	9	11	14	14	13	MLK0603L33NJT000	

Measurement equipment

Product No.	Manufacturer
4291B+16197A	Keysight Technologies

* Equivalent measurement equipment may be used.

MLK0603 type

L FREQUENCY CHARACTERISTICS (EXAMPLE)

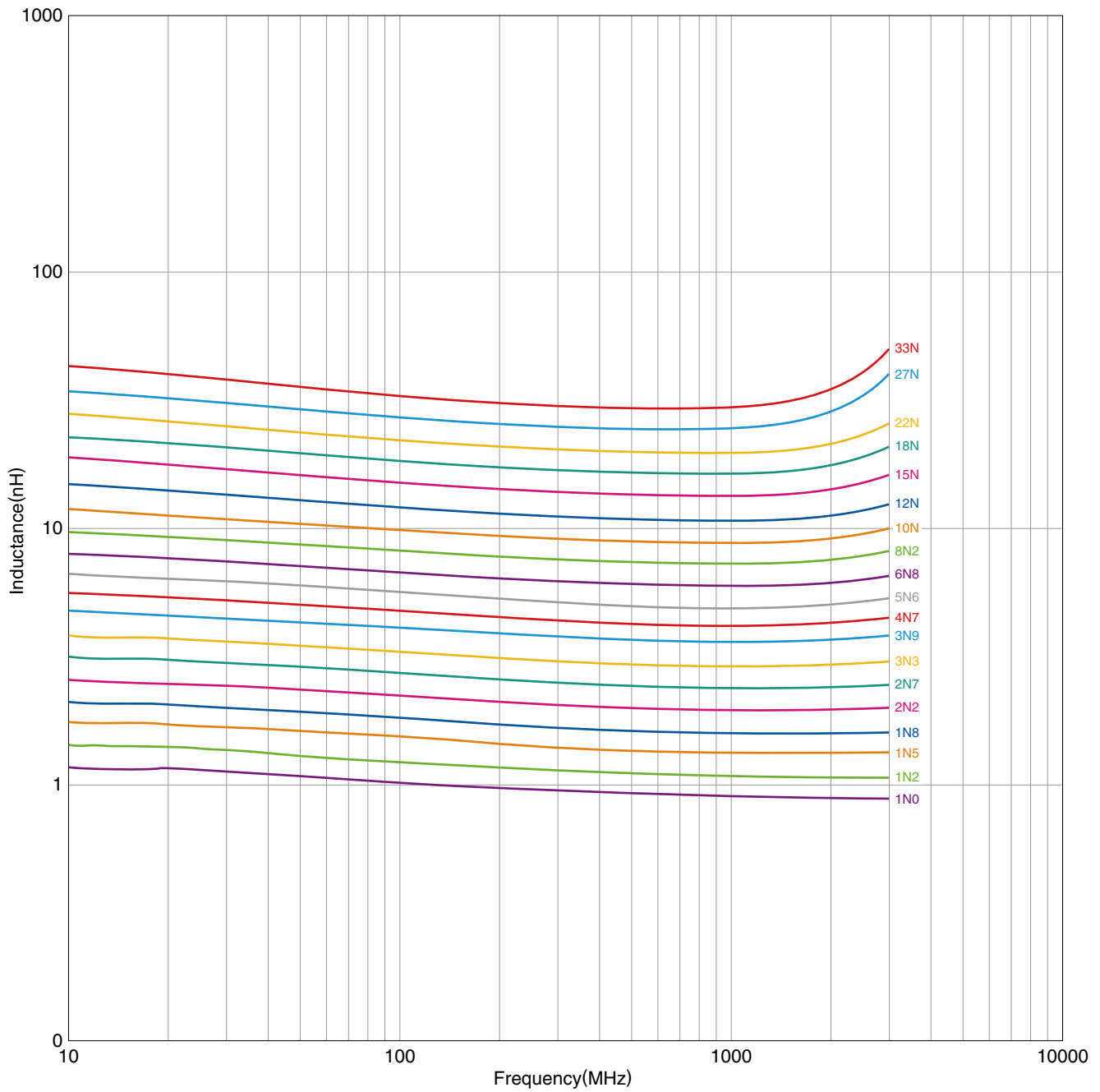

Measurement equipment

Product No.	Manufacturer
E4991A+16197A	Keysight Technologies

* Equivalent measurement equipment may be used.

MLK0603 type

■ Q FREQUENCY CHARACTERISTICS (EXAMPLE)

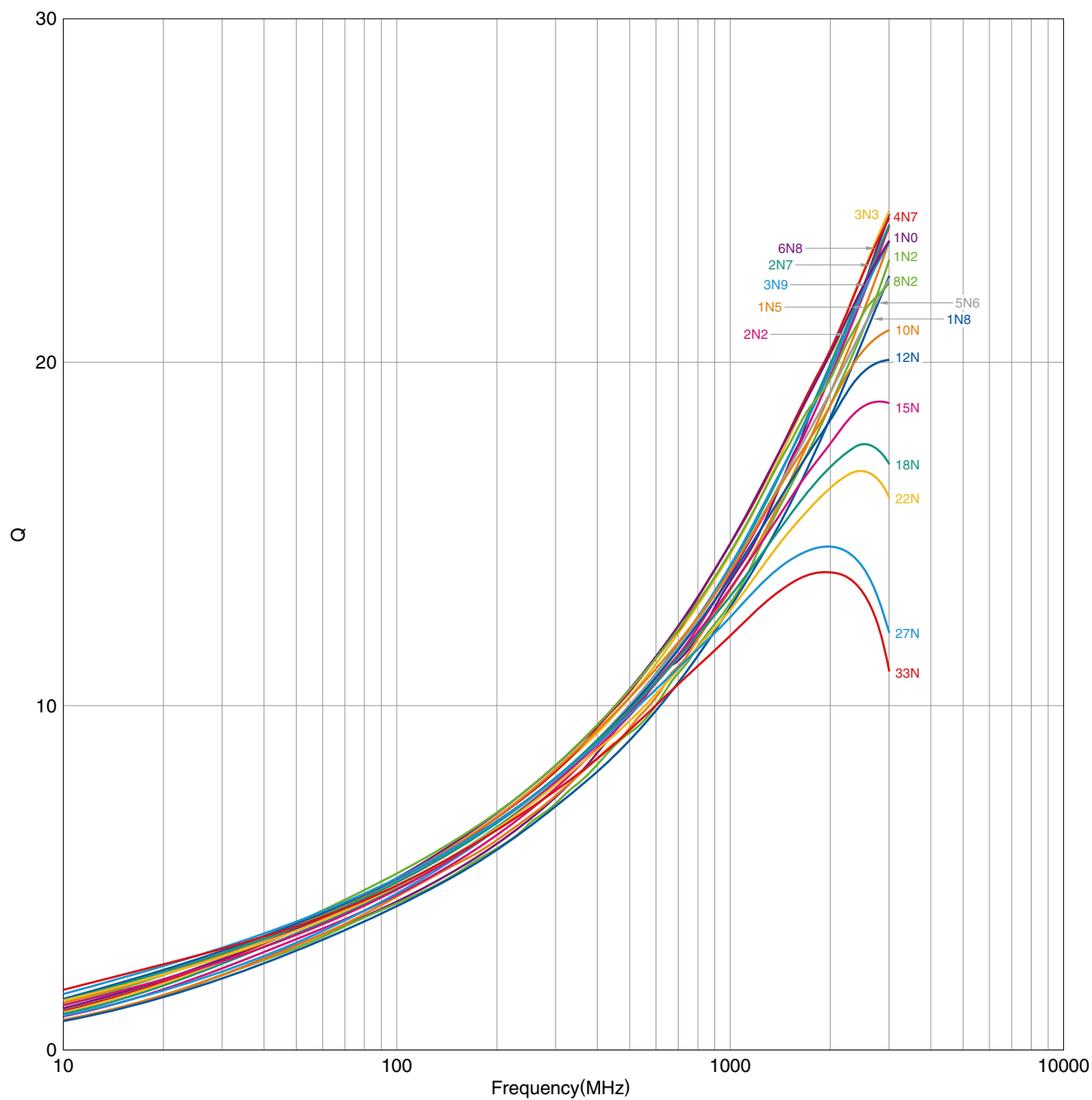

Measurement equipment

Product No.	Manufacturer
E4991A+16197A	Keysight Technologies

* Equivalent measurement equipment may be used.

MLK0603 type

SHAPE & DIMENSIONS

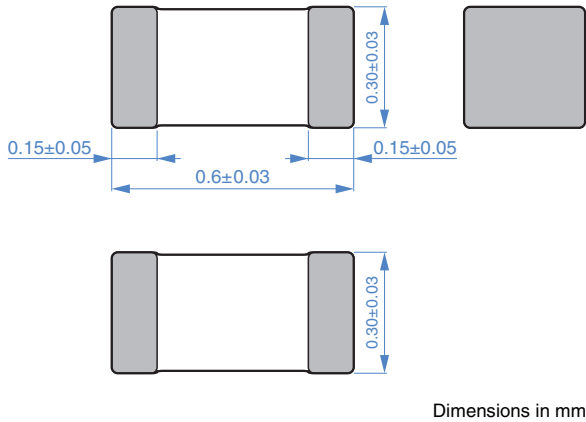

PACKAGING STYLE

REEL DIMENSIONS

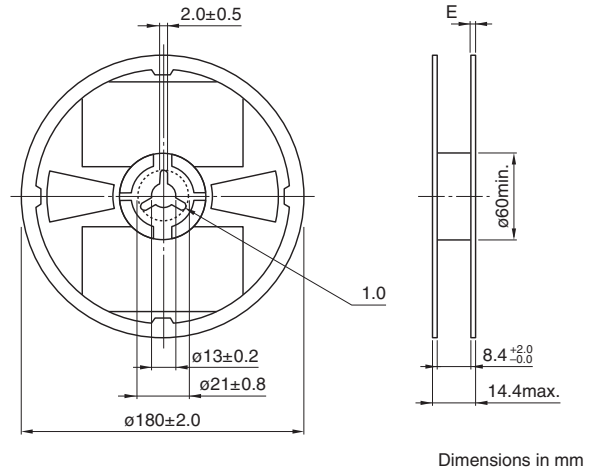

RECOMMENDED LAND PATTERN

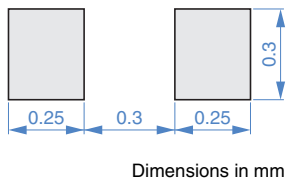

TAPE DIMENSIONS

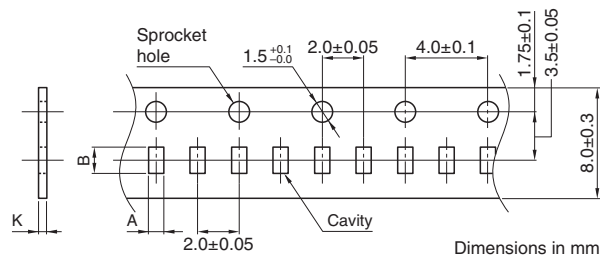

RECOMMENDED REFLOW PROFILE



Type	A	B	K
MLK0603	0.38±0.05	0.68±0.05	0.5 max.

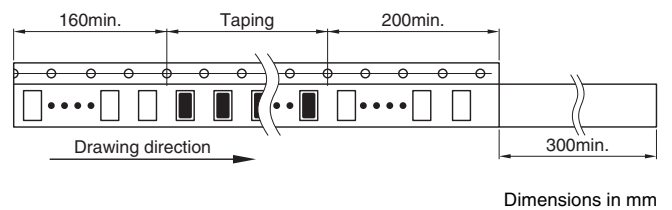

PACKAGE QUANTITY

Package quantity	15000 pcs/reel
------------------	----------------

TEMPERATURE RANGE, INDIVIDUAL WEIGHT

Operating temperature range	Storage temperature range*	Individual weight
-55 to +125 °C	-55 to +125 °C	0.2 mg

* The storage temperature range is for after the assembly.

REMINDERS FOR USING THESE PRODUCTS

Before using these products, be sure to request the delivery specifications.

SAFETY REMINDERS

Please pay sufficient attention to the warnings for safe designing when using this products.

REMINDERS

- The storage period is less than 12 months. Be sure to follow the storage conditions (temperature: 5 to 40°C, humidity: 10 to 75% RH or less).
If the storage period elapses, the soldering of the terminal electrodes may deteriorate.
- Do not use or store in locations where there are conditions such as gas corrosion (salt, acid, alkali, etc.).
- Before soldering, be sure to preheat components.
The preheating temperature should be set so that the temperature difference between the solder temperature and chip temperature does not exceed 150°C.
- Soldering corrections after mounting should be within the range of the conditions determined in the specifications.
If overheated, a short circuit, performance deterioration, or lifespan shortening may occur.
- When embedding a printed circuit board where a chip is mounted to a set, be sure that residual stress is not given to the chip due to the overall distortion of the printed circuit board and partial distortion such as at screw tightening portions.
- Self heating (temperature increase) occurs when the power is turned ON, so the tolerance should be sufficient for the set thermal design.
- Carefully lay out the coil for the circuit board design of the non-magnetic shield type.
A malfunction may occur due to magnetic interference.
- Use a wrist band to discharge static electricity in your body through the grounding wire.
- Do not expose the products to magnets or magnetic fields.
- Do not use for a purpose outside of the contents regulated in the delivery specifications.
- The products listed on this catalog are intended for use in general electronic equipment (AV equipment, telecommunications equipment, home appliances, amusement equipment, computer equipment, personal equipment, office equipment, measurement equipment, industrial robots) under a normal operation and use condition.
The products are not designed or warranted to meet the requirements of the applications listed below, whose performance and/or quality require a more stringent level of safety or reliability, or whose failure, malfunction or trouble could cause serious damage to society, person or property.
If you intend to use the products in the applications listed below or if you have special requirements exceeding the range or conditions set forth in the each catalog, please contact us.

- (1) Aerospace/aviation equipment
- (2) Transportation equipment (cars, electric trains, ships, etc.)
- (3) Medical equipment
- (4) Power-generation control equipment
- (5) Atomic energy-related equipment
- (6) Seabed equipment
- (7) Transportation control equipment

- (8) Public information-processing equipment
- (9) Military equipment
- (10) Electric heating apparatus, burning equipment
- (11) Disaster prevention/crime prevention equipment
- (12) Safety equipment
- (13) Other applications that are not considered general-purpose applications

When designing your equipment even for general-purpose applications, you are kindly requested to take into consideration securing protection circuit/device or providing backup circuits in your equipment.

Looking for pricing, stock, or lifecycle information?

Click below to explore more details on WIN SOURCE:

- ⊖ [View MLK0603L15NJT000 on WIN SOURCE](#)
- ⊖ [TDK Corporation Information](#)

Optimize Your Supply Chain with WIN SOURCE Solutions

- ✓ Global Sourcing Solution
- ✓ Obsolete Management
- ✓ Cost Control Management
- ✓ Shortage Management
- ✓ Alternative Solution
- ✓ Excess Inventory Management