



**THE DATASHEET OF  
MLP2520H3R3MT0S1**



Inductors for power circuits  
Multilayer ferrite  
MLP series



# MLP2520 type



## FEATURES

- A low-loss magnetic material is used so that a low-loss inductor for the power supply circuit can be achieved.
- In addition to the inductance value, product types with various features are available so that they can be compatible with different usages.
  - W type: products with low DC resistance and large current.
  - H type: this product uses a low-loss material and has low DC resistance.
    - \* Optimal for when heavy load power efficiency is important.
  - V type: as with the H type, this product with a low-loss magnetic material and that has good DC superimposition type characteristics.
    - \* Optimal for when light load power efficiency is important.
  - S type: STD product lineup that includes a wide L value and various sizes.
- Operating temperature range: -40 to +125°C (including self-temperature rise)

## APPLICATION

- Smart phones, tablet terminals, digital cameras, video cameras, HDDs, power supply modules, etc.
- Application guides: [Smart phones/tablets](#)

## PART NUMBER CONSTRUCTION

MLP	2520	W	R47	M	T	0S1
Series name	LxWxT dimensions 2.5x2.0 mm	Characteristic type	Inductance ( $\mu$ H)	Height 1.0 mm max. 1.2 mm max.	Packaging style	Internal code

## CHARACTERISTICS SPECIFICATION TABLE

Type	Thickness	L		Measuring frequency	DC resistance	Rated current*	Part No.
		T (mm)max.	( $\mu$ H) Tolerance				
Large current	Low resistance	1.0	0.47 $\pm$ 20%	2	0.033	2900	<a href="#">MLP2520WR47MT0S1</a>
		1.0	0.68 $\pm$ 20%	2	0.040	2800	<a href="#">MLP2520WR68MT0S1</a>
		1.0	1.0 $\pm$ 20%	2	0.048	2300	<a href="#">MLP2520W1R0MT0S1</a>
		1.0	1.5 $\pm$ 20%	2	0.075	1800	<a href="#">MLP2520W1R5MT0S1</a>
		1.0	2.2 $\pm$ 20%	2	0.16	1200	<a href="#">MLP2520W2R2MT0S1</a>
		1.0	3.3 $\pm$ 20%	2	0.16	1200	<a href="#">MLP2520W3R3MT0S1</a>
		1.0	4.7 $\pm$ 20%	2	0.15	1200	<a href="#">MLP2520W4R7MT0S1</a>

Background yellow: The product which is not recommended to a new design.

\* Rated current: current assumed when temperature has risen to 40°C max.

### Measurement equipment

Measurement item	Product No.	Manufacturer
L	4294A+16034G	Keysight Technologies
DC resistance	Type-7561	Yokogawa

\* Equivalent measurement equipment may be used.

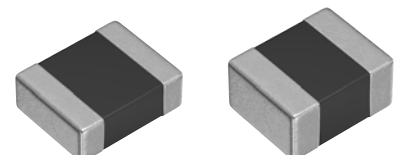

## MLP2520 type

## CHARACTERISTICS SPECIFICATION TABLE

Type	Thickness L			Measuring frequency (MHz)	DC resistance (Ω)±30%	Rated current* (mA)max.	Part No.	
	T (mm)max.	(μH)	Tolerance					
Emphasized low resistance	1.0	0.47	±20%	2	0.044	2100	<a href="#">MLP2520HR47MT0S1</a>	
	1.0	1.0	±20%	2	0.075	1500	<a href="#">MLP2520H1R0MT0S1</a>	
	1.0	2.2	±20%	2	0.09	1300	<a href="#">MLP2520H2R2MT0S1</a>	
	1.0	3.3	±20%	2	0.13	1100	<a href="#">MLP2520H3R3MT0S1</a>	
	1.0	4.7	±20%	2	0.13	1000	<a href="#">MLP2520H4R7MT0S1</a>	
	1.2	1.0	±20%	2	0.07	1600	<a href="#">MLP2520H1R0ST0S1</a>	
	1.2	2.2	±20%	2	0.08	1500	<a href="#">MLP2520H2R2ST0S1</a>	
	1.2	4.7	±20%	2	0.13	1000	<a href="#">MLP2520H4R7ST0S1</a>	
	Low core loss	1.0	0.47	±20%	2	0.06	1700	<a href="#">MLP2520VR47MT0S1</a>
		1.0	1.0	±20%	2	0.10	1300	<a href="#">MLP2520V1R0MT0S1</a>
		1.0	1.5	±20%	2	0.10	1400	<a href="#">MLP2520V1R5MT0S1</a>
		1.0	2.2	±20%	2	0.12	1100	<a href="#">MLP2520V2R2MT0S1</a>
1.0		3.3	±20%	2	0.20	900	<a href="#">MLP2520V3R3MT0S1</a>	
1.0		4.7	±20%	2	0.24	800	<a href="#">MLP2520V4R7MT0S1</a>	
1.2		1.0	±20%	2	0.10	1300	<a href="#">MLP2520V1R0ST0S1</a>	
1.2		1.5	±20%	2	0.10	1400	<a href="#">MLP2520V1R5ST0S1</a>	
1.2		2.2	±20%	2	0.12	1100	<a href="#">MLP2520V2R2ST0S1</a>	
1.2		4.7	±20%	2	0.22	800	<a href="#">MLP2520V4R7ST0S1</a>	
STD product		1.0	1.0	±20%	2	0.085	1500	<a href="#">MLP2520S1R0MT0S1</a>
		1.0	1.5	±20%	2	0.09	1200	<a href="#">MLP2520S1R5MT0S1</a>
	1.0	2.2	±20%	2	0.09	1200	<a href="#">MLP2520S2R2MT0S1</a>	
	1.0	3.3	±20%	2	0.13	1000	<a href="#">MLP2520S3R3MT0S1</a>	
	1.0	4.7	±20%	2	0.13	1000	<a href="#">MLP2520S4R7MT0S1</a>	
	1.0	10.0	±20%	2	0.28	700	<a href="#">MLP2520S100MT0S1</a>	
	1.2	1.2	±20%	2	0.08	1500	<a href="#">MLP2520S1R0ST0S1</a>	
	1.2	2.5	±20%	2	0.11	1200	<a href="#">MLP2520S2R2ST0S1</a>	
	1.2	3.3	±20%	2	0.11	1000	<a href="#">MLP2520S3R3ST0S1</a>	
	1.2	4.7	±20%	2	0.11	1000	<a href="#">MLP2520S4R7ST0S1</a>	
	1.2	10.0	±20%	2	0.28	700	<a href="#">MLP2520S100ST0S1</a>	

Background yellow: The product which is not recommended to a new design.

\* Rated current: current assumed when temperature has risen to 40°C max.

## Measurement equipment

Measurement item	Product No.	Manufacturer
L	4294A+16034G	Keysight Technologies
DC resistance	Type-7561	Yokogawa

\* Equivalent measurement equipment may be used.

# MLP2520 type (W characteristic product, T dimension of the product 1.0mm max.)

## L FREQUENCY CHARACTERISTICS

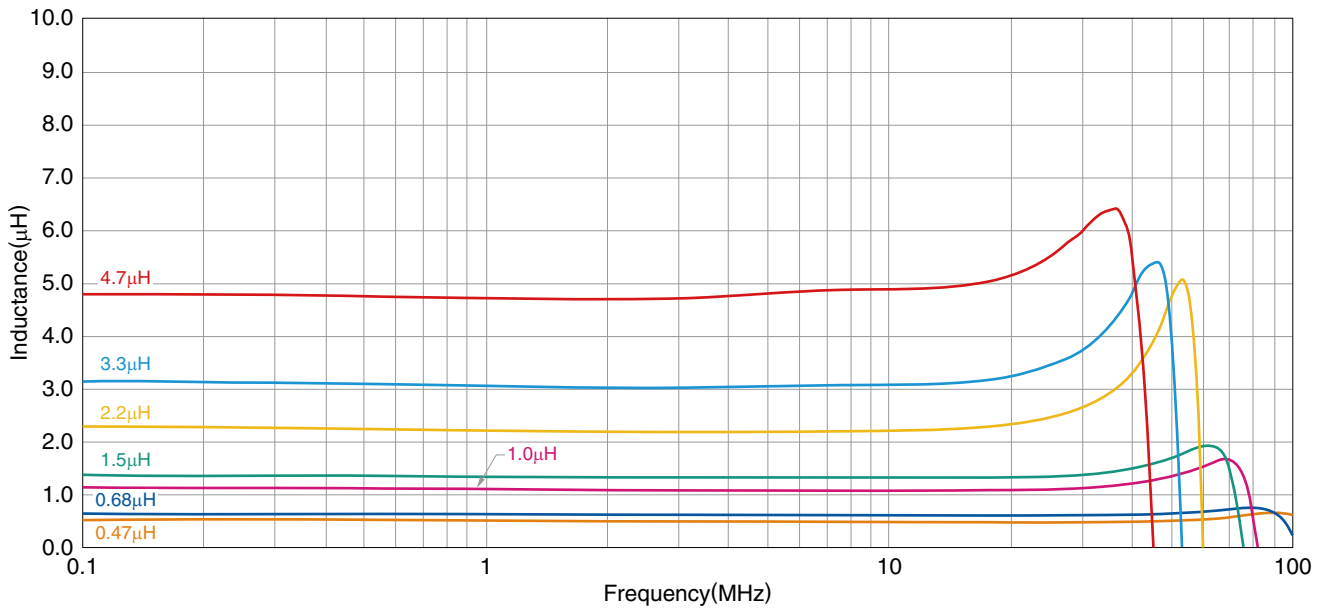

Measurement equipment

Product No.	Manufacturer
4294A+16034G	Keysight Technologies

\* Equivalent measurement equipment may be used.

## INDUCTANCE VS. DC BIAS CHARACTERISTICS

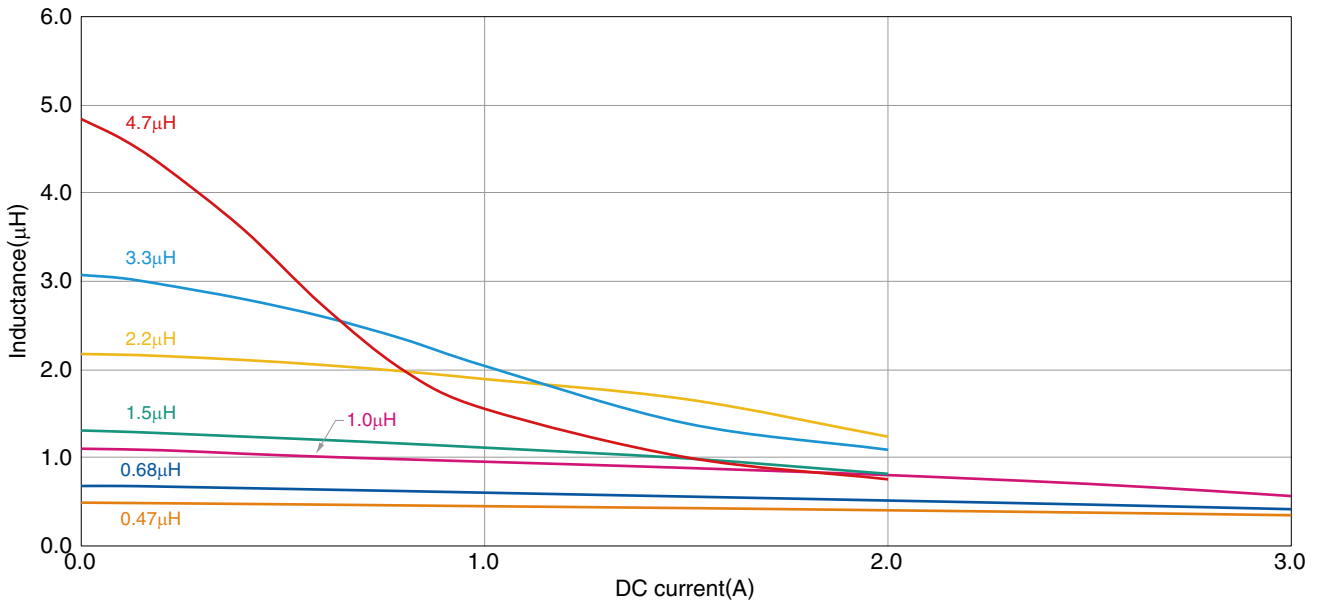

Measurement equipment

Product No.	Manufacturer
4285A+42841A+42842C+42851-61100	Keysight Technologies

\* Equivalent measurement equipment may be used.

# MLP2520 type (H characteristic product, T dimension of the product 1.0mm max.)

## L FREQUENCY CHARACTERISTICS

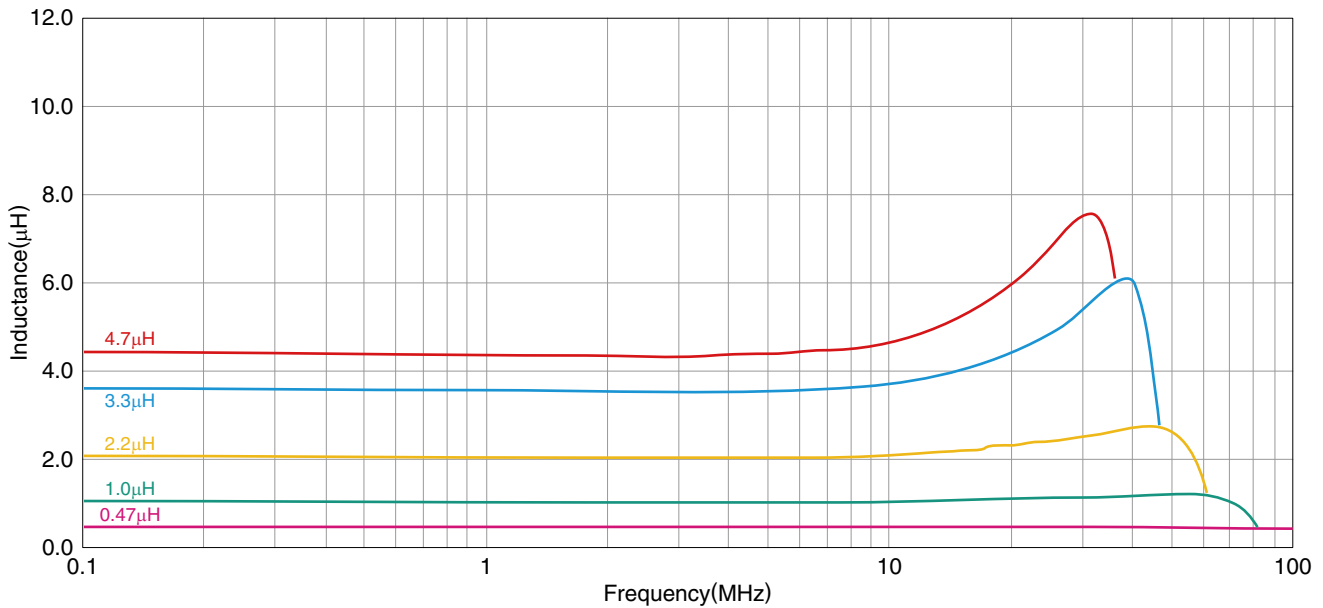

Measurement equipment

Product No.	Manufacturer
4294A+16034G	Keysight Technologies

\* Equivalent measurement equipment may be used.

## INDUCTANCE VS. DC BIAS CHARACTERISTICS

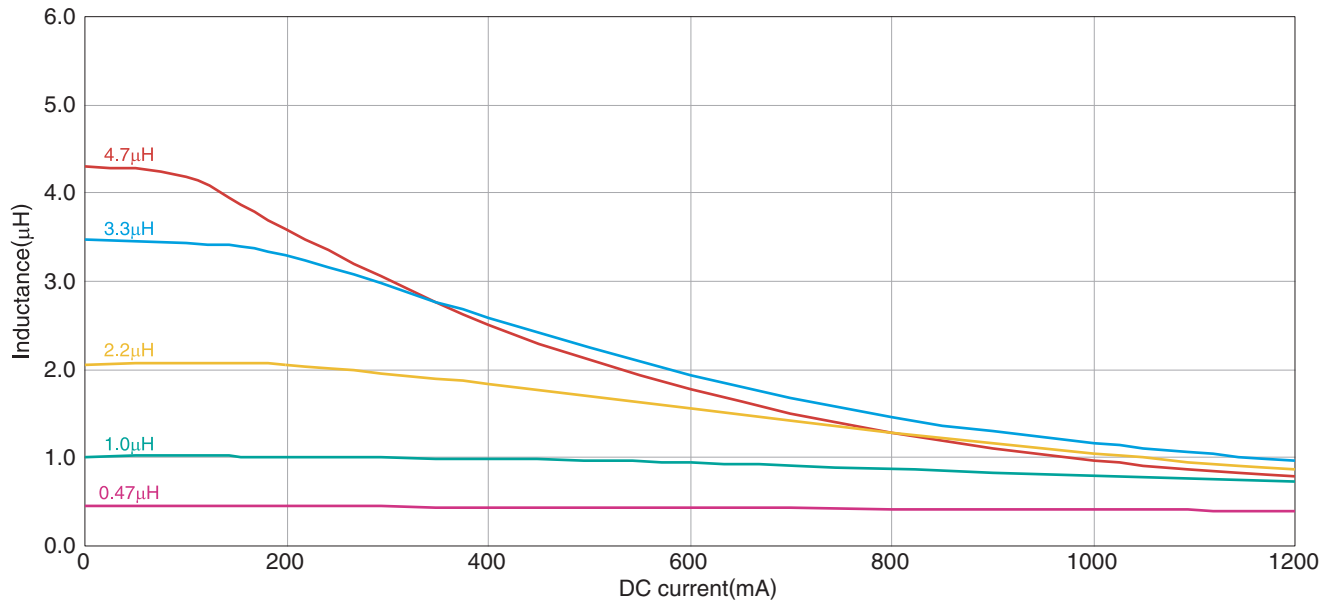

Measurement equipment

Product No.	Manufacturer
4285A+42841A+42842C+42851-61100	Keysight Technologies

\* Equivalent measurement equipment may be used.

# MLP2520 type (H characteristic product, T dimension of the product 1.2mm max.)

## L FREQUENCY CHARACTERISTICS

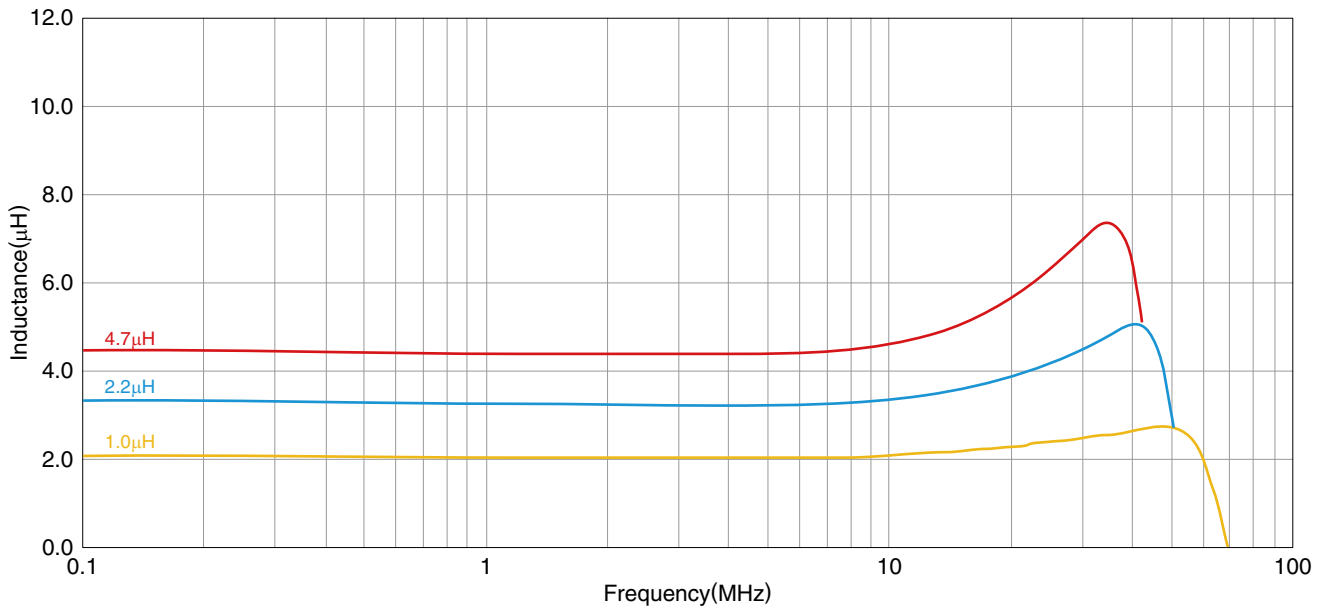

Measurement equipment

Product No.	Manufacturer
4294A+16034G	Keysight Technologies

\* Equivalent measurement equipment may be used.

## INDUCTANCE VS. DC BIAS CHARACTERISTICS

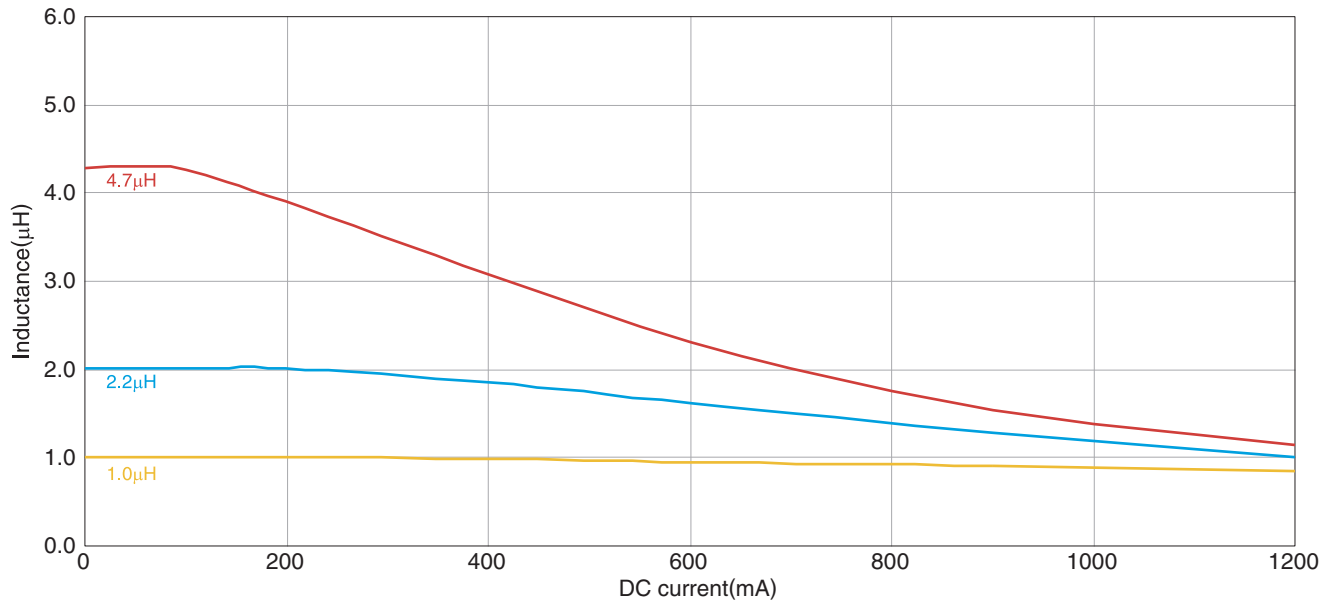

Measurement equipment

Product No.	Manufacturer
4285A+42841A+42842C+42851-61100	Keysight Technologies

\* Equivalent measurement equipment may be used.

# MLP2520 type (V characteristic product, T dimension of the product 1.0mm max.)

## L FREQUENCY CHARACTERISTICS

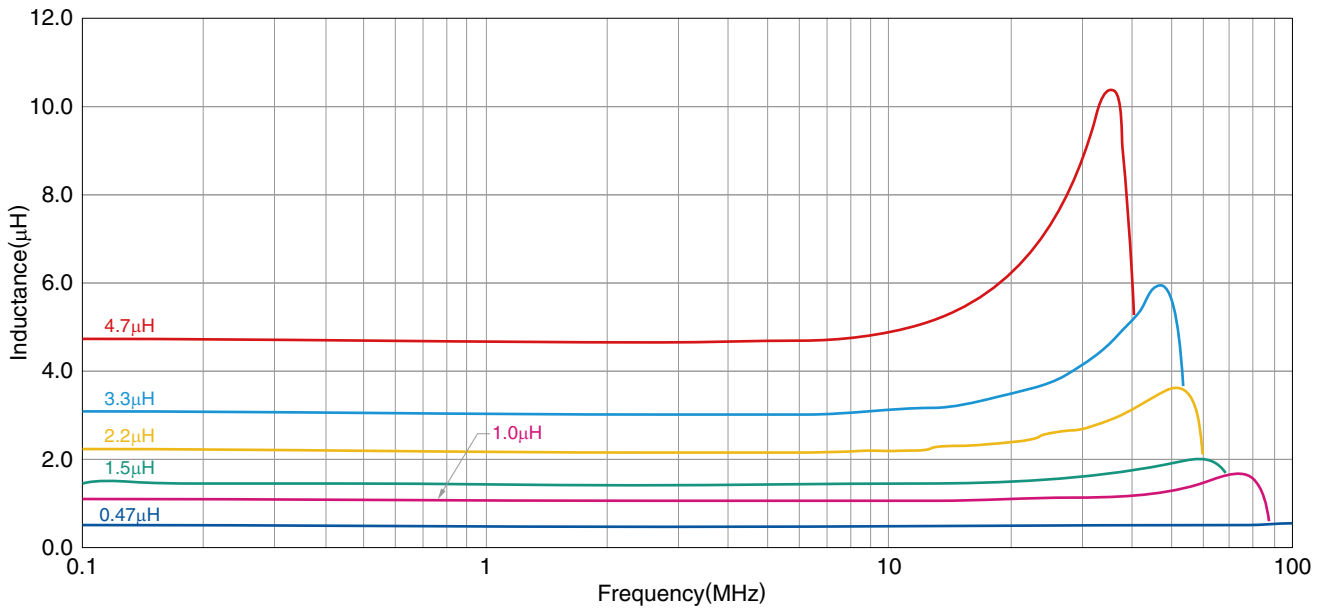

Measurement equipment

Product No.	Manufacturer
4294A+16034G	Keysight Technologies

\* Equivalent measurement equipment may be used.

## INDUCTANCE VS. DC BIAS CHARACTERISTICS

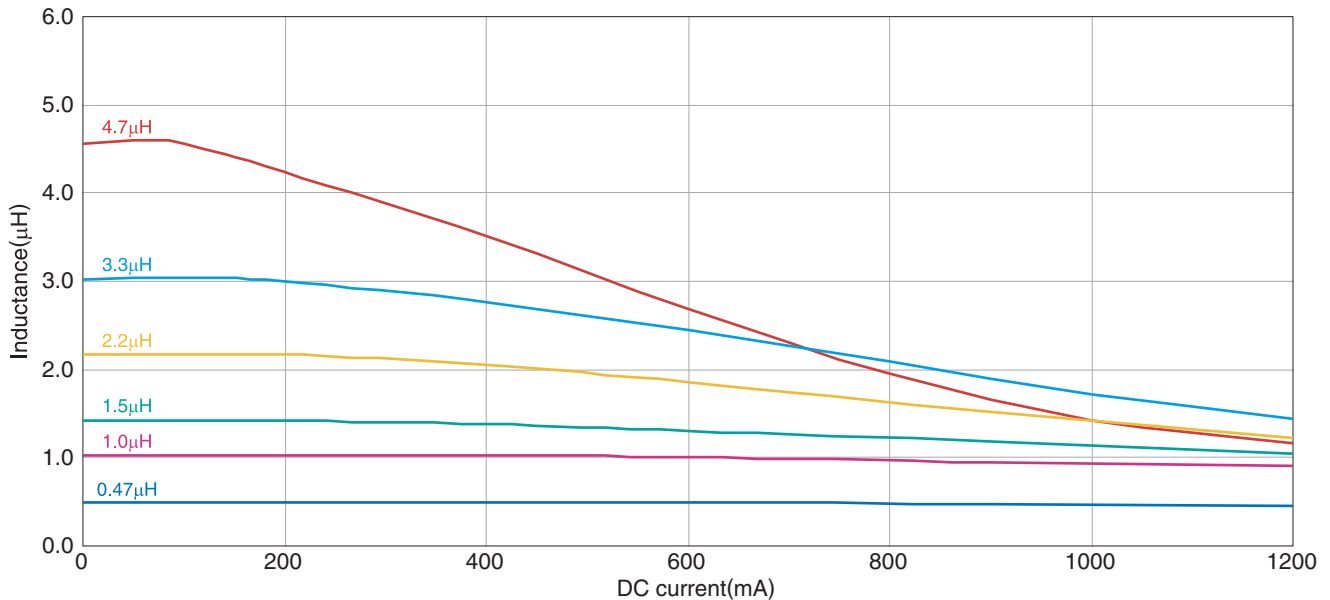

Measurement equipment

Product No.	Manufacturer
4285A+42841A+42842C+42851-61100	Keysight Technologies

\* Equivalent measurement equipment may be used.

# MLP2520 type (V characteristic product, T dimension of the product 1.2mm max.)

## L FREQUENCY CHARACTERISTICS

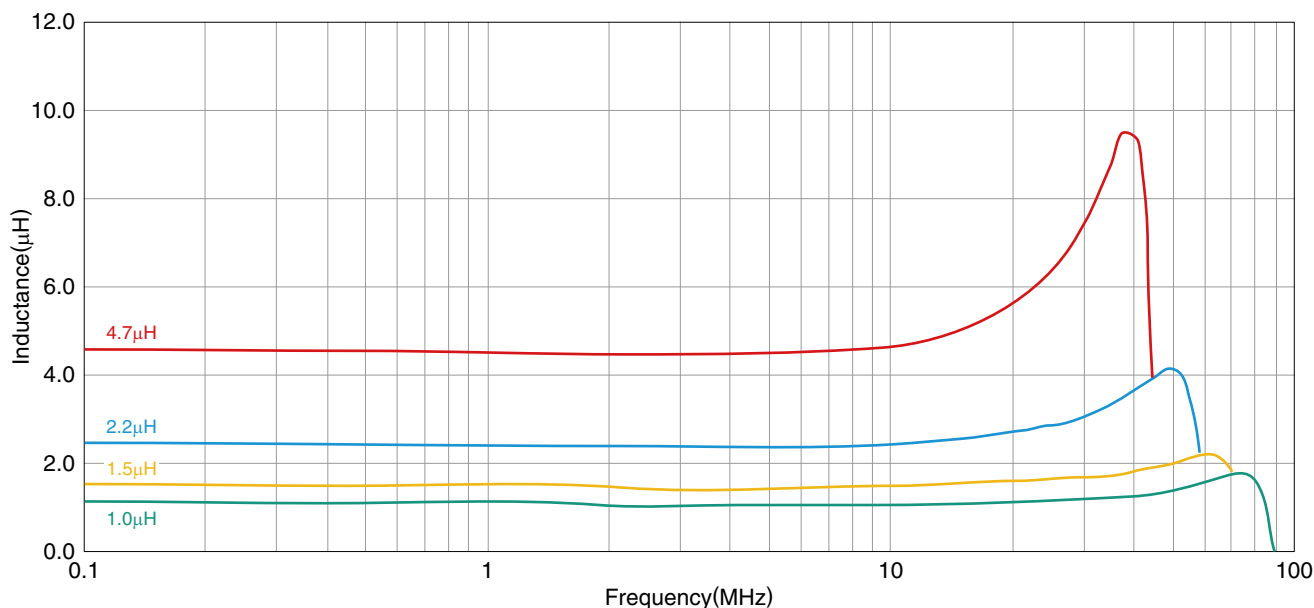

Measurement equipment

Product No.	Manufacturer
4294A+16034G	Keysight Technologies

\* Equivalent measurement equipment may be used.

## INDUCTANCE VS. DC BIAS CHARACTERISTICS

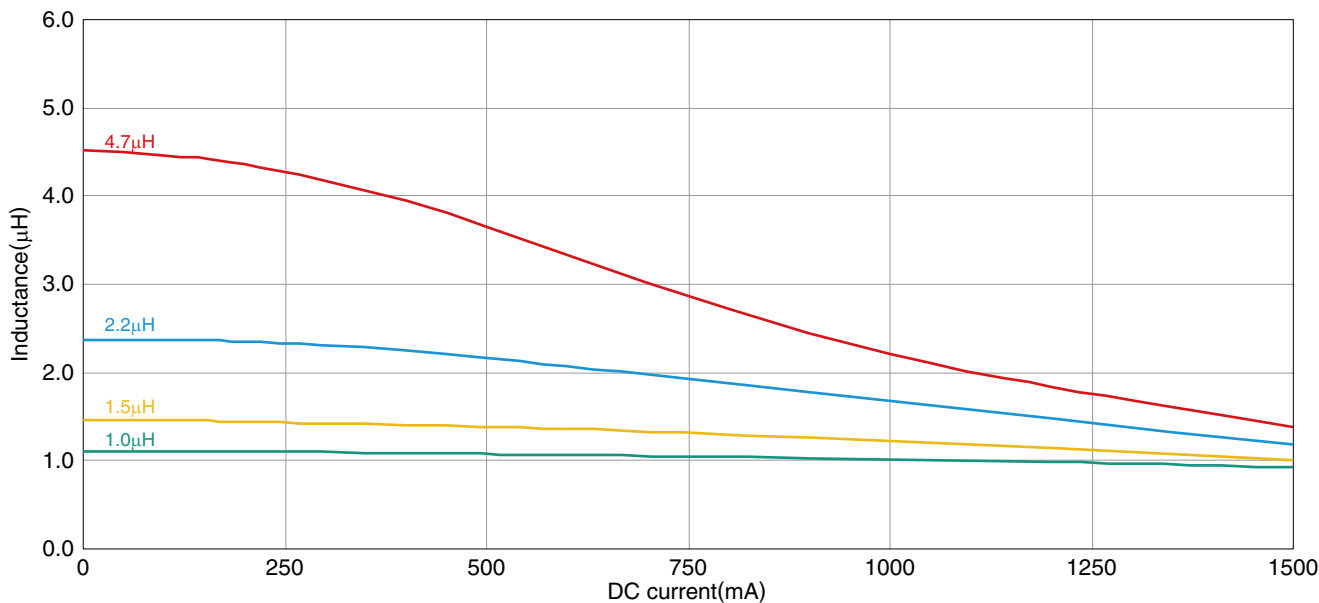

Measurement equipment

Product No.	Manufacturer
4285A+42841A+42842C+42851-61100	Keysight Technologies

\* Equivalent measurement equipment may be used.

# MLP2520 type (S characteristic product, T dimension of the product 1.0mm max.)

## L FREQUENCY CHARACTERISTICS

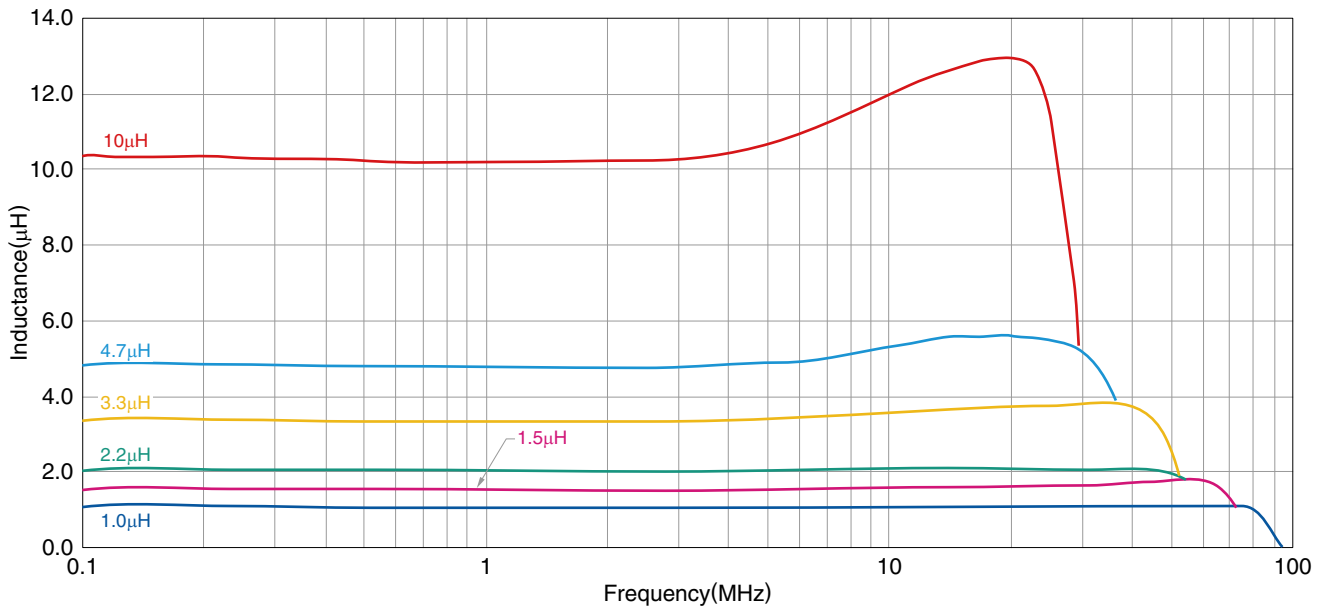

Measurement equipment

Product No.	Manufacturer
4294A+16034G	Keysight Technologies

\* Equivalent measurement equipment may be used.

## INDUCTANCE VS. DC BIAS CHARACTERISTICS

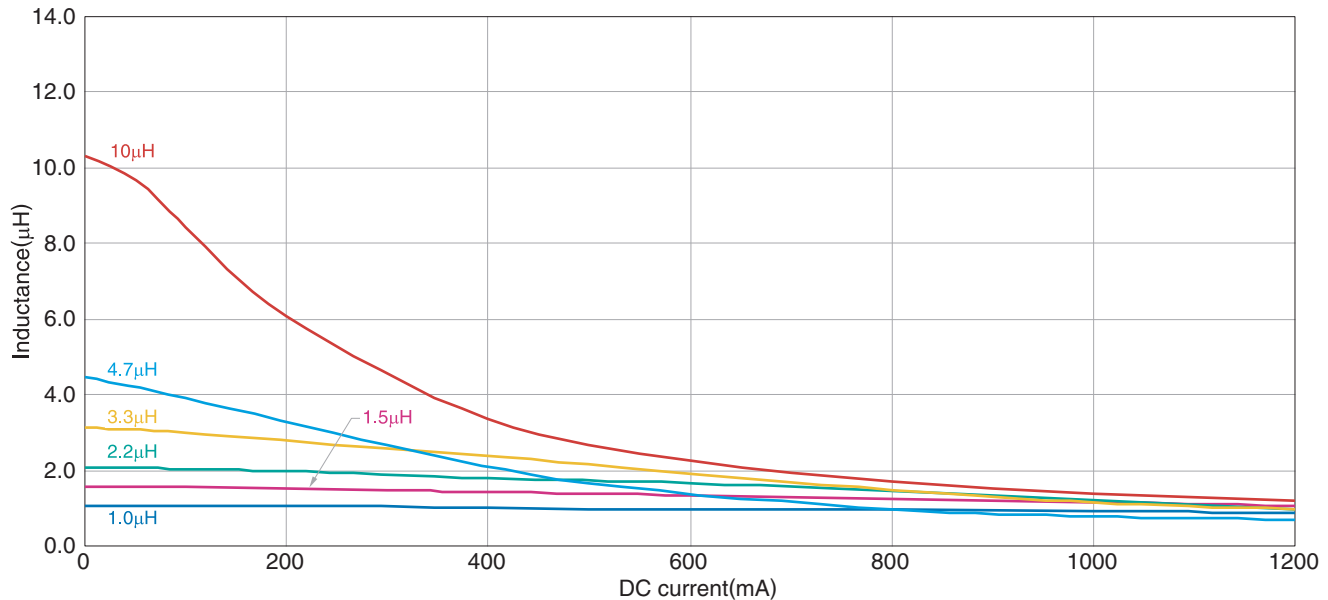

Measurement equipment

Product No.	Manufacturer
4285A+42841A+42842C+42851-61100	Keysight Technologies

\* Equivalent measurement equipment may be used.

# MLP2520 type (S characteristic product, T dimension of the product 1.2mm max.)

## L FREQUENCY CHARACTERISTICS

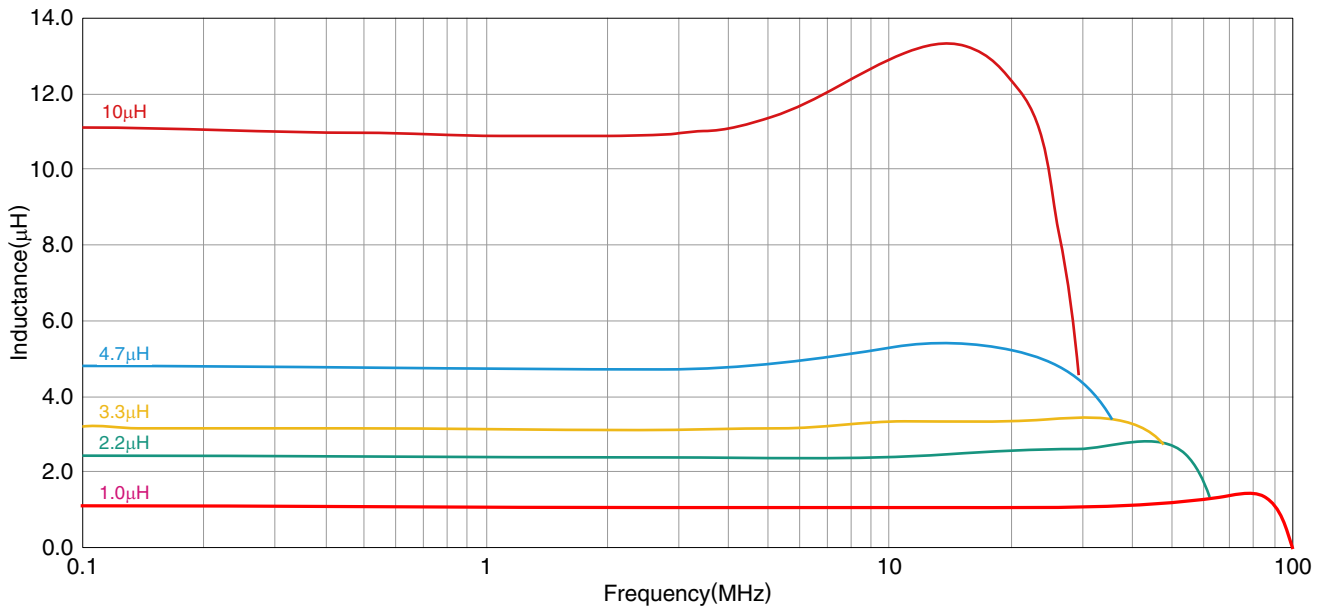

Measurement equipment

Product No.	Manufacturer
4294A+16034G	Keysight Technologies

\* Equivalent measurement equipment may be used.

## INDUCTANCE VS. DC BIAS CHARACTERISTICS

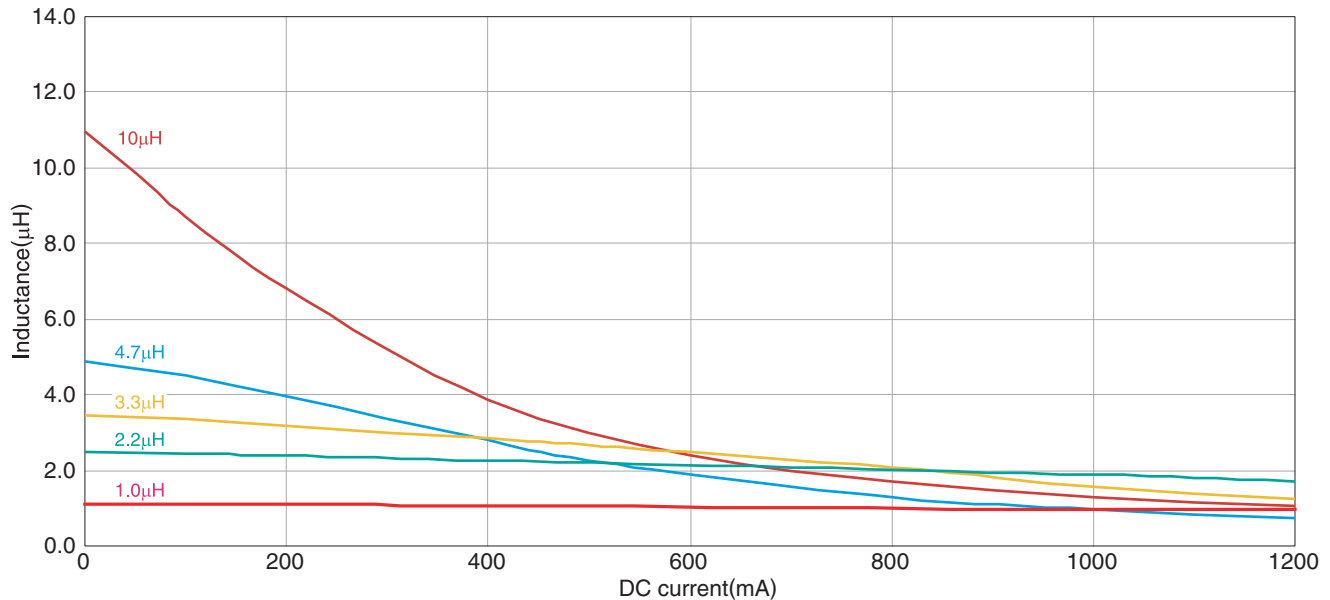

Measurement equipment

Product No.	Manufacturer
4285A+42841A+42842C+42851-61100	Keysight Technologies

\* Equivalent measurement equipment may be used.

# MLP2520 type

## SHAPE & DIMENSIONS

t=1.0mm

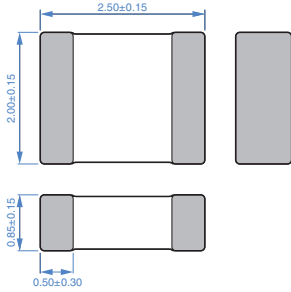

t=1.2mm

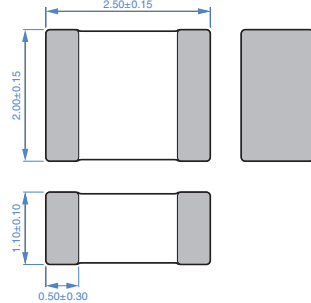

Dimensions in mm

## PACKAGING STYLE

### REEL DIMENSIONS

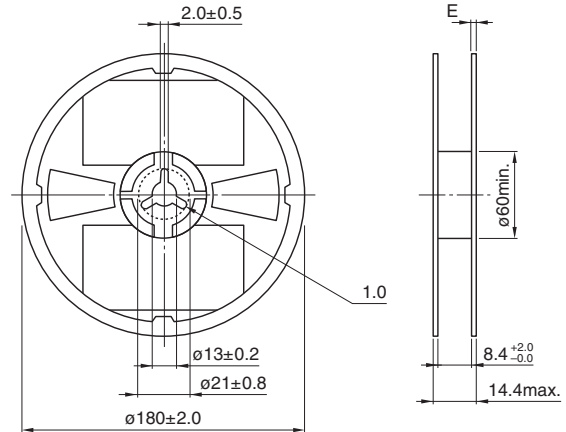

Dimensions in mm

## RECOMMENDED LAND PATTERN

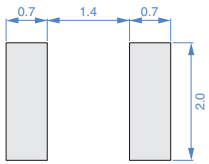

Dimensions in mm

### TAPE DIMENSIONS

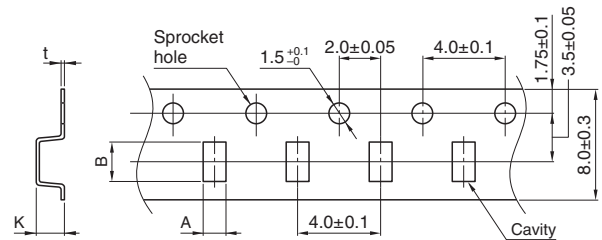

Dimensions in mm

Type	A	B	K	
MLP2520	t=1.0	2.3±0.1	2.7±0.1	1.2 max.
	t=1.2	2.3±0.1	2.7±0.1	1.5 max.

## RECOMMENDED REFLOW PROFILE

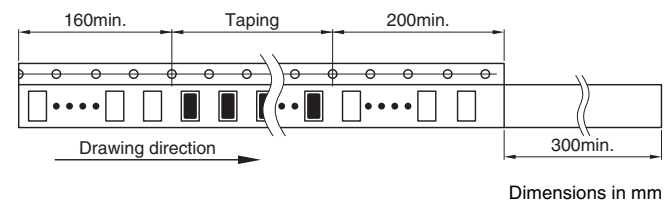
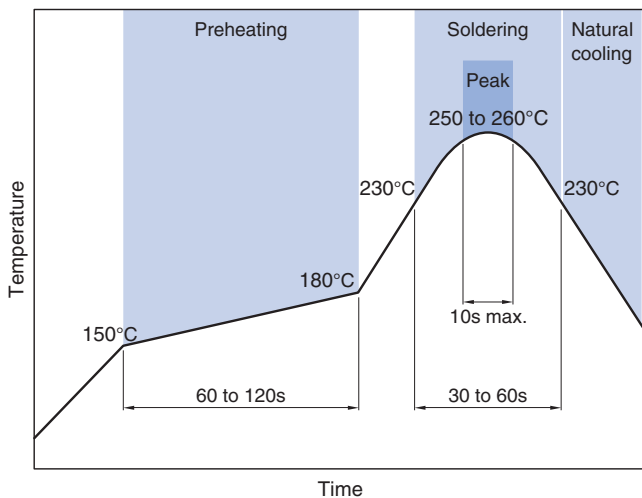

Dimensions in mm

### PACKAGE QUANTITY

Package quantity	3000 pcs/reel
------------------	---------------

## TEMPERATURE RANGE, INDIVIDUAL WEIGHT

Type	Operating temperature range*	Storage temperature range**	Individual weight
t=1.0	-40 to +125 °C	-40 to +85 °C	15 mg
t=1.2	-40 to +125 °C	-40 to +85 °C	25 mg

\* Operating temperature range includes self-temperature rise.

\*\* The storage temperature range is for after the assembly.

## REMINDERS FOR USING THESE PRODUCTS

Before using these products, be sure to request the delivery specifications.

### SAFETY REMINDERS

Please pay sufficient attention to the warnings for safe designing when using this products.

#### REMINDERS

- The storage period is within 12 months. Be sure to follow the storage conditions (temperature: 5 to 40°C, humidity: 10 to 75% RH or less).  
If the storage period elapses, the soldering of the terminal electrodes may deteriorate.
- Do not use or store in locations where there are conditions such as gas corrosion (salt, acid, alkali, etc.).
- Before soldering, be sure to preheat components.  
The preheating temperature should be set so that the temperature difference between the solder temperature and chip temperature does not exceed 150°C.
- Soldering corrections after mounting should be within the range of the conditions determined in the specifications.  
If overheated, a short circuit, performance deterioration, or lifespan shortening may occur.
- When embedding a printed circuit board where a chip is mounted to a set, be sure that residual stress is not given to the chip due to the overall distortion of the printed circuit board and partial distortion such as at screw tightening portions.
- Self heating (temperature increase) occurs when the power is turned ON, so the tolerance should be sufficient for the set thermal design.
- Carefully lay out the coil for the circuit board design of the non-magnetic shield type.  
A malfunction may occur due to magnetic interference.
- Use a wrist band to discharge static electricity in your body through the grounding wire.
- Do not expose the products to magnets or magnetic fields.
- Do not use for a purpose outside of the contents regulated in the delivery specifications.
- The products listed on this catalog are intended for use in general electronic equipment (AV equipment, telecommunications equipment, home appliances, amusement equipment, computer equipment, personal equipment, office equipment, measurement equipment, industrial robots) under a normal operation and use condition.  
The products are not designed or warranted to meet the requirements of the applications listed below, whose performance and/or quality require a more stringent level of safety or reliability, or whose failure, malfunction or trouble could cause serious damage to society, person or property.  
If you intend to use the products in the applications listed below or if you have special requirements exceeding the range or conditions set forth in the each catalog, please contact us.

- (1) Aerospace/aviation equipment
- (2) Transportation equipment (cars, electric trains, ships, etc.)
- (3) Medical equipment
- (4) Power-generation control equipment
- (5) Atomic energy-related equipment
- (6) Seabed equipment
- (7) Transportation control equipment

- (8) Public information-processing equipment
- (9) Military equipment
- (10) Electric heating apparatus, burning equipment
- (11) Disaster prevention/crime prevention equipment
- (12) Safety equipment
- (13) Other applications that are not considered general-purpose applications

When designing your equipment even for general-purpose applications, you are kindly requested to take into consideration securing protection circuit/device or providing backup circuits in your equipment.

## Looking for pricing, stock, or lifecycle information?

Click below to explore more details on WIN SOURCE:

 [View MLP2520H3R3MT0S1 on WIN SOURCE](#)

 [TDK Corporation](#) Information

## Optimize Your Supply Chain with WIN SOURCE Solutions

-  Global Sourcing Solution
-  Obsolete Management
-  Cost Control Management
-  Shortage Management
-  Alternative Solution
-  Excess Inventory Management