



**THE DATASHEET OF
MM74C902N**



MM74C901 • MM74C902

Hex Inverting TTL Buffer • Hex Non-Inverting TTL Buffer

General Description

The MM74C901 and MM74C902 hex buffers employ complementary MOS to achieve wide supply operating range, low power consumption, and high noise immunity. These buffers provide direct interface from PMOS into CMOS or TTL and direct interface from CMOS to TTL or CMOS operating at a reduced V_{CC} supply.

Features

- Wide supply voltage range: 3.0V to 15V
- Guaranteed noise margin: 1.0V
- High noise immunity: $0.45 V_{CC}$ (typ.)
- TTL compatibility: Fan out of 2 driving standard TTL

Ordering Code:

Order Number	Package Number	Package Description
MM74C901M	M14A	14-Lead Small Outline Integrated Circuit (SOIC), JEDEC MS-120, 0.150" Narrow
MM74C901N	N14A	14-Lead Plastic Dual-In-Line Package (PDIP), JEDEC MS-011, 0.300" Wide
MM74C902M	M14A	14-Lead Small Outline Integrated Circuit (SOIC), JEDEC MS-120, 0.150" Narrow
MM74C902N	N14A	14-Lead Plastic Dual-In-Line Package (PDIP), JEDEC MS-011, 0.300" Wide

Devices also available in Tape and Reel. Specify by appending the suffix letter "X" to the ordering code.

Connection Diagrams

Pin Assignments for DIP and SOIC

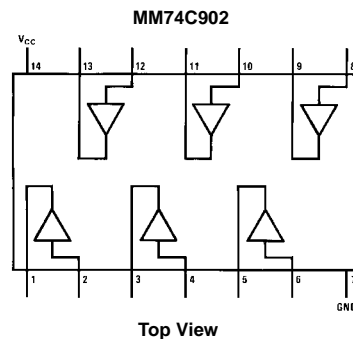
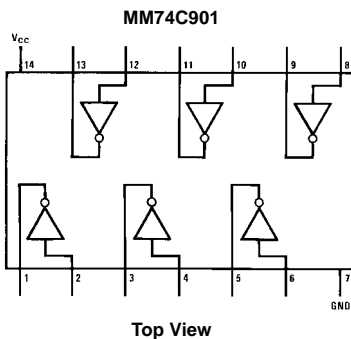

Logic Diagrams

MM74C901
CMOS to TTL Inverting Buffer

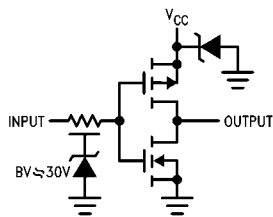

MM74C902
CMOS to TTL Buffer

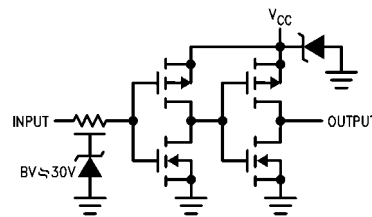

Absolute Maximum Ratings (Note 1)		Operating V_{CC} Range	3.0V to 15V
Voltage at Any Pin	-0.3V to $V_{CC} + 0.3V$	Absolute Maximum V_{CC}	18V
Voltage at Any Input Pin		Lead Temperature (T_L)	
MM74C901	-0.3V to +15V	(Soldering, 10 seconds)	260°C
MM74C902	-0.3V to +15V		
Storage Temperature Range (T_S)	-65°C to +150°C		
Power Dissipation (P_D)			
Dual-In-Line	700 mW		
Small Outline	500 mW		
Operating Temperature Range (T_A)			
MM74C901, MM74C902,	-40°C to +85°C		

Note 1: "Absolute Maximum Ratings" are those values beyond which the safety of the device cannot be guaranteed. Except for "Operating Temperature Range" they are not meant to imply that the devices should be operated at these limits. The table of "Electrical Characteristics" provides conditions for actual device operation.

DC Electrical Characteristics

Min/Max limits apply across temperature range unless otherwise noted

Symbol	Parameter	Conditions	Min	Typ	Max	Units
CMOS TO CMOS						
$V_{IN(1)}$	Logical "1" Input Voltage	$V_{CC} = 5.0V$ $V_{CC} = 10V$	3.5 8.0			V V
$V_{IN(0)}$	Logical "0" Input Voltage	$V_{CC} = 5.0V$ $V_{CC} = 10V$			1.5 2.0	V V
$V_{OUT(1)}$	Logical "1" Output Voltage	$V_{CC} = 5.0V, I_O = -10 \mu A$ $V_{CC} = 10V, I_O = -10 \mu A$	4.5 9.0			V V
$V_{OUT(0)}$	Logical "0" Output Voltage	$V_{CC} = 5.0V$ $V_{CC} = 10V$			0.5 1.0	V V
$I_{IN(1)}$	Logical "1" Input Current	$V_{CC} = 15V, V_{IN} = 15V$		0.005	1.0	μA
$I_{IN(0)}$	Logical "0" Input Current	$V_{CC} = 15V, V_{IN} = 0V$	-1.0	-0.005		μA
I_{CC}	Supply Current	$V_{CC} = 15V$		0.05	15	μA
TTL TO CMOS						
$V_{IN(1)}$	Logical "1" Input Voltage	$V_{CC} = 4.75V$		$V_{CC} - 1.5$		V
$V_{IN(0)}$	Logical "0" Input Voltage	$V_{CC} = 4.75V$			0.8	V
CMOS TO TTL						
$V_{IN(1)}$	Logical "1" Input Voltage					
	MM74C901	$V_{CC} = 4.75V$	4.25			V
	MM74C902	$V_{CC} = 4.75V$	$V_{CC} - 1.5$			V
$V_{IN(0)}$	Logical "0" Input Voltage					
	MM74C901	$V_{CC} = 4.75V$			1.0	V
	MM74C902	$V_{CC} = 4.75V$			1.5	V
$V_{OUT(1)}$	Logical "1" Output Voltage	$V_{CC} = 4.75V, I_O = -800 \mu A$	2.4			V
$V_{OUT(0)}$	Logical "0" Output Voltage					
	MM74C901	$V_{CC} = 4.75V, I_O = 2.6 mA$			0.4	V
	MM74C902	$V_{CC} = 4.75V, I_O = 3.2 mA$			0.4	V
OUTPUT DRIVE (See Family Characteristics Data Sheet) (Short Circuit Current)						
(MM74C901)						
I_{SOURCE}	Output Source Current (P-Channel)	$V_{CC} = 5.0V, V_{OUT} = 0V$ $T_A = 25^\circ C, V_{IN} = 0V$	-5.0			mA
I_{SOURCE}	Output Source Current (P-Channel)	$V_{CC} = 10V, V_{OUT} = 0V$ $T_A = 25^\circ C, V_{IN} = 0V$	-20			mA
I_{SINK}	Output Sink Current (N-Channel)	$V_{CC} = 5.0V, V_{OUT} = V_{CC}$ $T_A = 25^\circ C, V_{IN} = V_{CC}$	9.0			mA
I_{SINK}	Output Sink Current (N-Channel)	$V_{CC} = 5.0V, V_{OUT} = 0.4V$ $T_A = 25^\circ C, V_{IN} = V_{CC}$	3.8			mA
(MM74C902)						

AC Test Circuit and Switching Time Waveforms

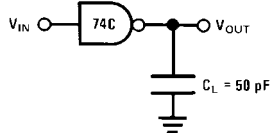

Note: Delays measured with input $t_r, t_f = 20 \text{ ns}$.

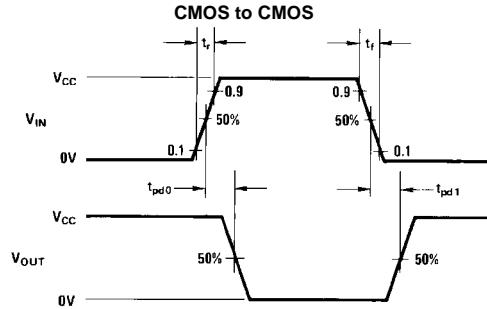

Typical Performance Characteristics

Typical Propagation Delay to a Logical "0" for the MM74C901

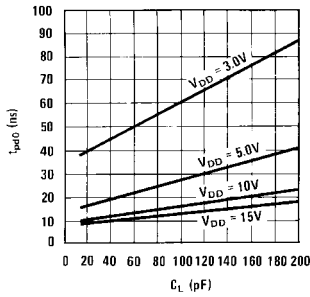

Typical Propagation Delay to a Logical "1" for the MM74C901

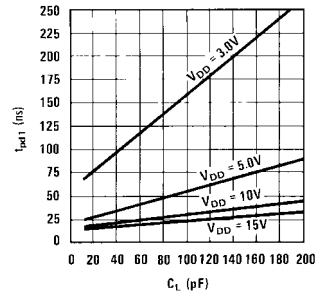

Typical Propagation Delay to a Logical "0" for the MM74C902

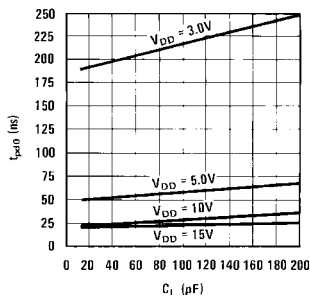

Typical Propagation Delay to a Logical "1" for the MM74C902

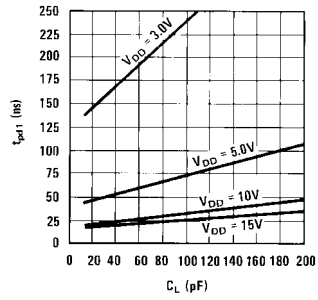

Physical Dimensions inches (millimeters) unless otherwise noted

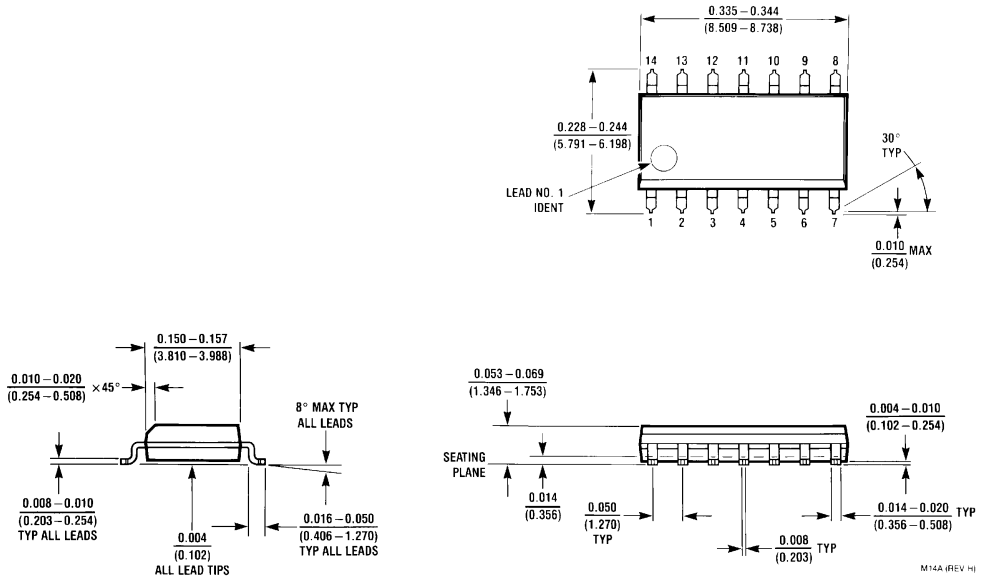

**14-Lead Plastic Dual-In-Line Package (PDIP), JEDEC MS-120, 0.150" Narrow
Package Number M14A**

Physical Dimensions inches (millimeters) unless otherwise noted (Continued)

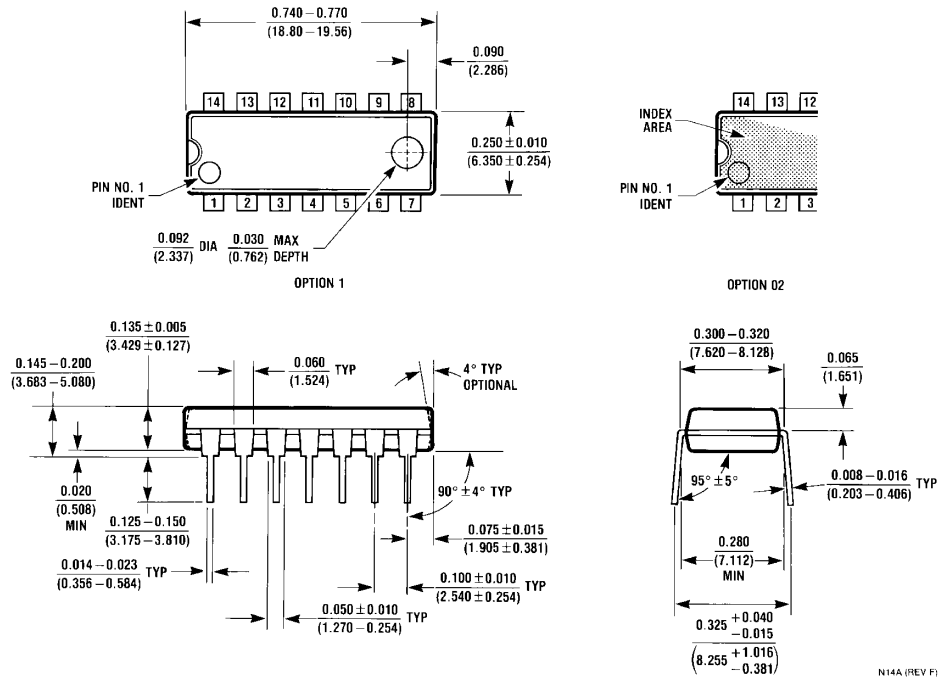

14-Lead Plastic Dual-In-Line Package (PDIP), JEDEC MS-001, 0.300" Wide Package Number N14A

LIFE SUPPORT POLICY



FAIRCHILD'S PRODUCTS ARE NOT AUTHORIZED FOR USE AS CRITICAL COMPONENTS IN LIFE SUPPORT DEVICES OR SYSTEMS WITHOUT THE EXPRESS WRITTEN APPROVAL OF THE PRESIDENT OF FAIRCHILD SEMICONDUCTOR CORPORATION. As used herein:

1. Life support devices or systems are devices or systems which, (a) are intended for surgical implant into the body, or (b) support or sustain life, and (c) whose failure to perform when properly used in accordance with instructions for use provided in the labeling, can be reasonably expected to result in a significant injury to the user.
2. A critical component in any component of a life support device or system whose failure to perform can be reasonably expected to cause the failure of the life support device or system, or to affect its safety or effectiveness.

www.fairchildsemi.com

Looking for pricing, stock, or lifecycle information?

Click below to explore more details on WIN SOURCE:

-  [View MM74C902N on WIN SOURCE](#)
-  [Fairchild/ON Semiconductor Information](#)

Optimize Your Supply Chain with WIN SOURCE Solutions

-  Global Sourcing Solution
-  Obsolete Management
-  Cost Control Management
-  Shortage Management
-  Alternative Solution
-  Excess Inventory Management