



**THE DATASHEET OF  
MMBT2131T1**



# MMBT2131T1G

## General Purpose Transistors

### PNP Bipolar Junction Transistor

**NOTE: Voltage and Current are negative for the PNP Transistor.**

#### Features

- These Devices are Pb-Free and are RoHS Compliant

#### MAXIMUM RATINGS ( $T_C = 25^\circ\text{C}$ unless otherwise noted)

Rating	Symbol	Value	Unit
Collector-Emitter Voltage	$V_{CEO}$	30	V
Collector-Base Voltage	$V_{CBO}$	40	V
Emitter-Base Voltage	$V_{EBO}$	5.0	V
Collector Current	$I_C$	700	mA
Base Current	$I_B$	350	mA
Total Power Dissipation @ $T_C = 25^\circ\text{C}$	$P_D$	342	mW
Total Power Dissipation @ $T_C = 85^\circ\text{C}$	$P_D$	178	mW
Thermal Resistance, Junction-to-Ambient (Note 1)	$R_{\theta JA}$	366	$^\circ\text{C/W}$
Total Power Dissipation @ $T_C = 25^\circ\text{C}$	$P_D$	665	mW
Total Power Dissipation @ $T_C = 85^\circ\text{C}$	$P_D$	346	mW
Thermal Resistance, Junction-to-Ambient (Note 2)	$R_{\theta JA}$	188	$^\circ\text{C/W}$
Operating and Storage Temperature Range	$T_J, T_{stg}$	-55 to +150	$^\circ\text{C}$

Stresses exceeding Maximum Ratings may damage the device. Maximum Ratings are stress ratings only. Functional operation above the Recommended Operating Conditions is not implied. Extended exposure to stresses above the Recommended Operating Conditions may affect device reliability.

1. Minimum FR-4 or G-10 PCB, Operating to Steady State.
2. Mounted onto a 2" square FR-4 Board (1" sq. 2 oz Cu 0.06" thick single sided), Operating to Steady State.



**ON Semiconductor®**

<http://onsemi.com>

**0.7 AMPERES**  
**30 VOLTS –  $V_{(BR)CEO}$**   
**342 mW**

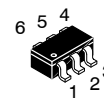
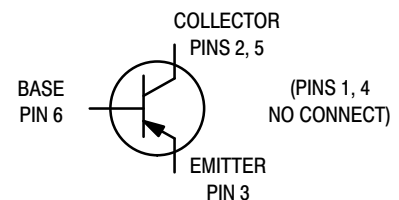

**SC-74**  
**CASE 318F**  
**STYLE 2**

#### MARKING DIAGRAM

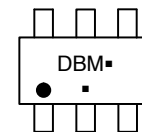

DB = Device Code  
M = Date Code\*  
▪ = Pb-Free Package

(Note: Microdot may be in either location)  
\*Date Code orientation may vary depending upon manufacturing location.

#### ORDERING INFORMATION

Device	Package	Shipping†
MMBT2131T1G	SC-74 (Pb-Free)	3000/Tape & Reel

†For information on tape and reel specifications, including part orientation and tape sizes, please refer to our Tape and Reel Packaging Specification Brochure, BRD8011/D.

# MMBT2131T1G

## ELECTRICAL CHARACTERISTICS (T<sub>C</sub> = 25°C unless otherwise noted)

Characteristic	Symbol	Min	Typ	Max	Unit
<b>OFF CHARACTERISTICS</b>					
Collector-Base Breakdown Voltage (I <sub>C</sub> = 100 μA)	V <sub>(BR)CBO</sub>	40	-	-	V
Collector-Emitter Breakdown Voltage (I <sub>C</sub> = 10 mA)	V <sub>(BR)CEO</sub>	30	-	-	V
Emitter-Base Breakdown Voltage (I <sub>E</sub> = 100 μA)	V <sub>(BR)EBO</sub>	5.0	-	-	V
Collector Cutoff Current (V <sub>CB</sub> = 25 V, I <sub>E</sub> = 0 A) (V <sub>CB</sub> = 25 V, I <sub>E</sub> = 0 A, T <sub>A</sub> = 125°C)	I <sub>CBO</sub>	-	-	1.0 10	μA
Emitter Cutoff Current (V <sub>EB</sub> = 5.0 V, I <sub>C</sub> = 0 A)	I <sub>EBO</sub>	-	-	10	μA
<b>ON CHARACTERISTICS</b>					
DC Current Gain (V <sub>CE</sub> = 3.0 V, I <sub>C</sub> = 100 mA)	h <sub>FE</sub>	150	-	-	V
Collector-Emitter Saturation Voltage (I <sub>C</sub> = 500 mA, I <sub>B</sub> = 50 mA)	V <sub>CE(sat)</sub>	-	-	0.25	V
Collector-Emitter Saturation Voltage (I <sub>C</sub> = 700 mA, I <sub>B</sub> = 70 mA)	V <sub>CE(sat)</sub>	-	-	0.4	V
Base-Emitter Saturation Voltage (I <sub>C</sub> = 700 mA, I <sub>B</sub> = 70 mA)	V <sub>BE(sat)</sub>	-	-	1.1	V
Collector-Emitter Saturation Voltage (I <sub>C</sub> = 700 mA, V <sub>CE</sub> = 1.0 V)	V <sub>BE(on)</sub>	-	-	1.0	V

## TYPICAL CHARACTERISTICS

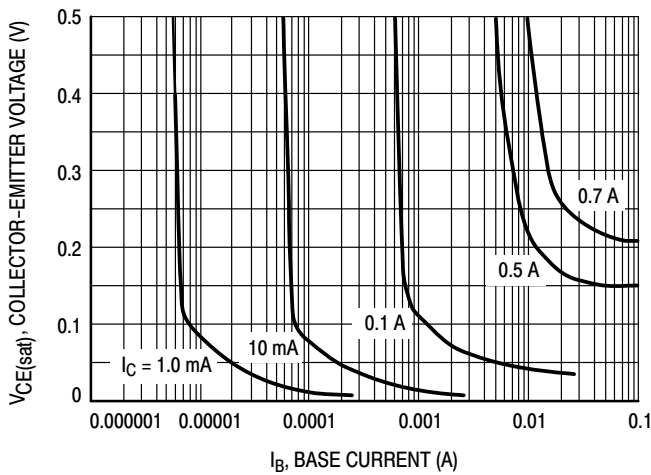

Figure 1. Collector Saturation Region

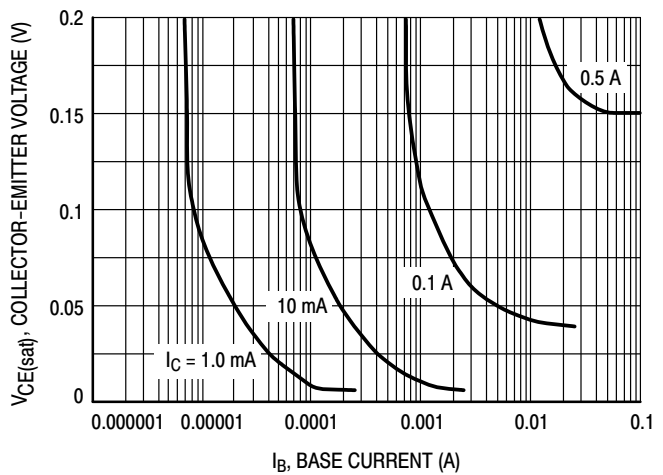

Figure 2. Collector Saturation Region

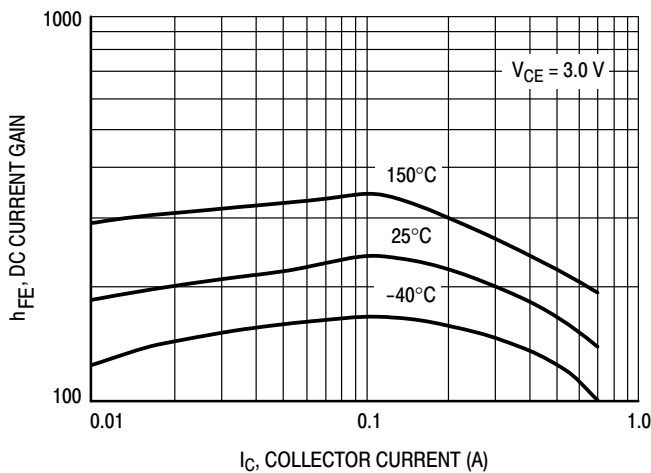

Figure 3. DC Current Gain

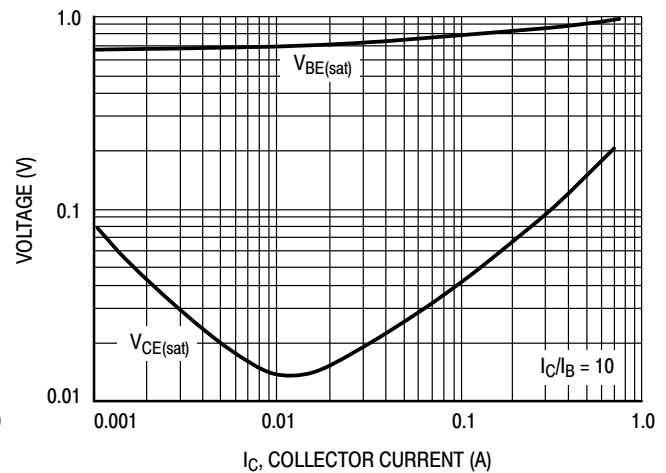

Figure 4. "ON" Voltages

# MMBT2131T1G

## TYPICAL CHARACTERISTICS

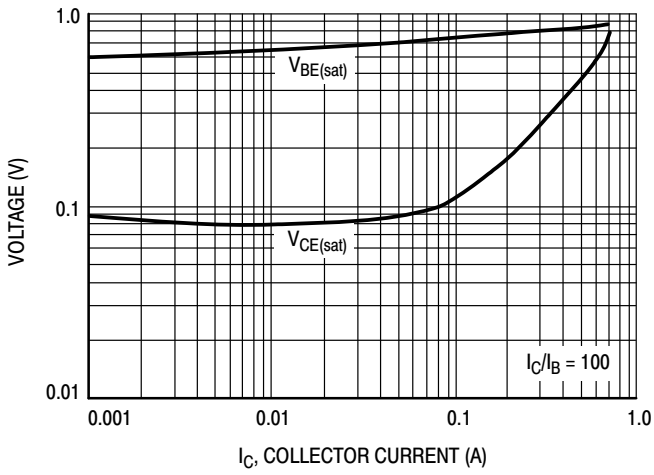

Figure 5. "ON" Voltages

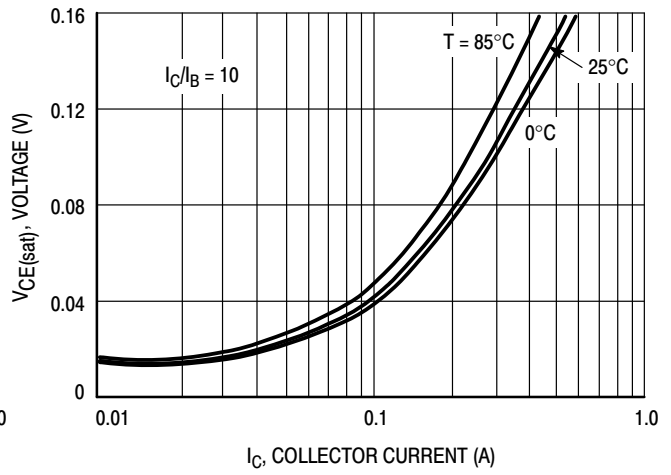

Figure 6. Collector-Emitter Saturation Voltage

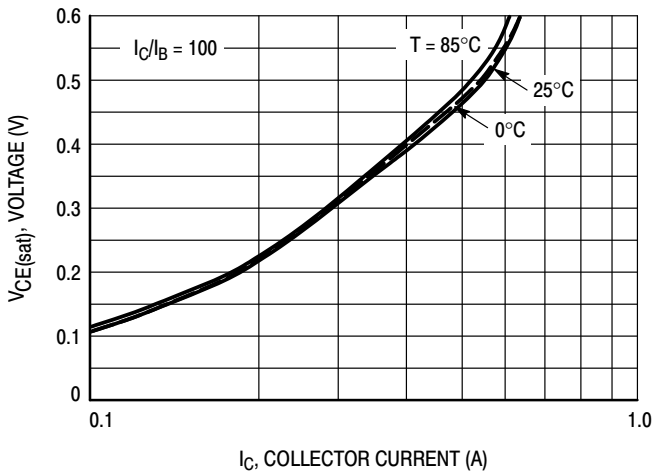

Figure 7. Collector-Emitter Saturation Voltage

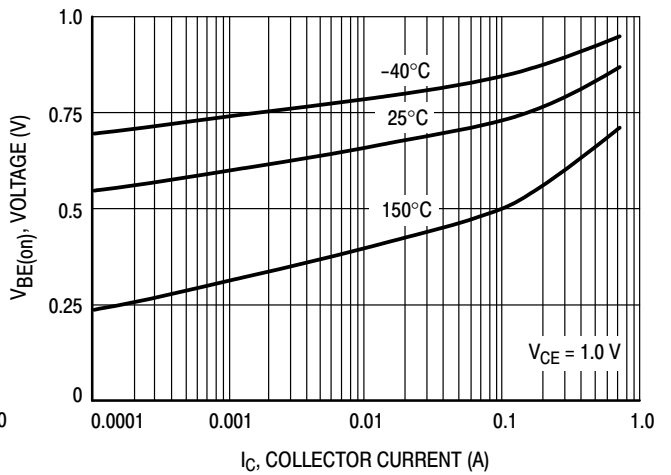

Figure 8.  $V_{BE(on)}$  Voltage

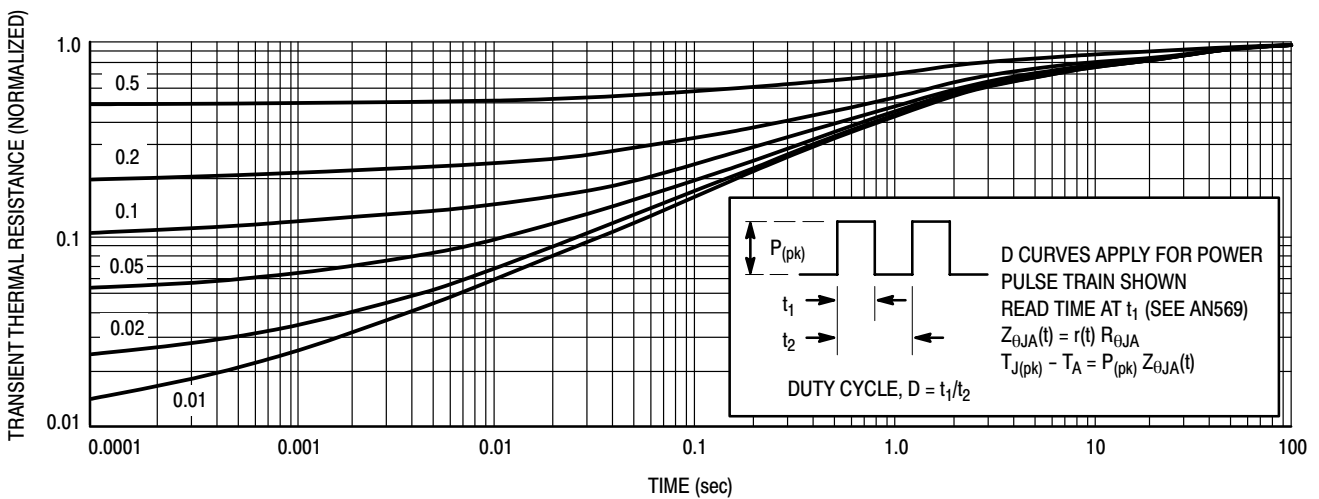
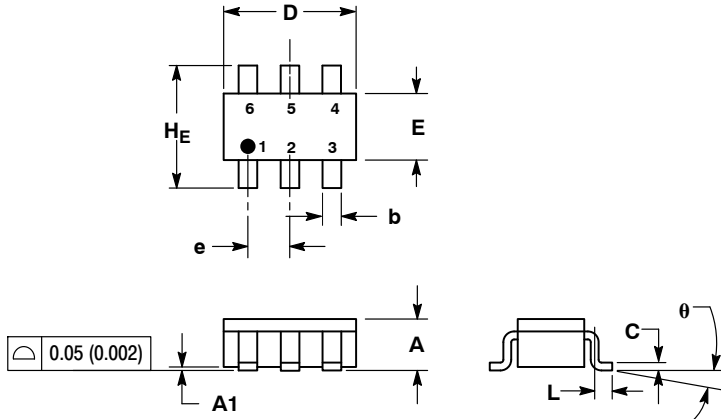

Figure 9. Thermal Response Curve

# MMBT2131T1G

## PACKAGE DIMENSIONS

SC-74  
CASE 318F-05  
ISSUE N



NOTES:

1. DIMENSIONING AND TOLERANCING PER ANSI Y14.5M, 1982.
2. CONTROLLING DIMENSION: INCH.
3. MAXIMUM LEAD THICKNESS INCLUDES LEAD FINISH THICKNESS. MINIMUM LEAD THICKNESS IS THE MINIMUM THICKNESS OF BASE MATERIAL.
4. 318F-01, -02, -03, -04 OBSOLETE. NEW STANDARD 318F-05.

DIM	MILLIMETERS			INCHES		
	MIN	NOM	MAX	MIN	NOM	MAX
A	0.90	1.00	1.10	0.035	0.039	0.043
A1	0.01	0.06	0.10	0.001	0.002	0.004
b	0.25	0.37	0.50	0.010	0.015	0.020
c	0.10	0.18	0.26	0.004	0.007	0.010
D	2.90	3.00	3.10	0.114	0.118	0.122
E	1.30	1.50	1.70	0.051	0.059	0.067
e	0.85	0.95	1.05	0.034	0.037	0.041
L	0.20	0.40	0.60	0.008	0.016	0.024
HE	2.50	2.75	3.00	0.099	0.108	0.118
θ	0°	-	10°	0°	-	10°

STYLE 2:

1. NO CONNECTION
2. COLLECTOR
3. EMITTER
4. NO CONNECTION
5. COLLECTOR
6. BASE

### SOLDERING FOOTPRINT\*

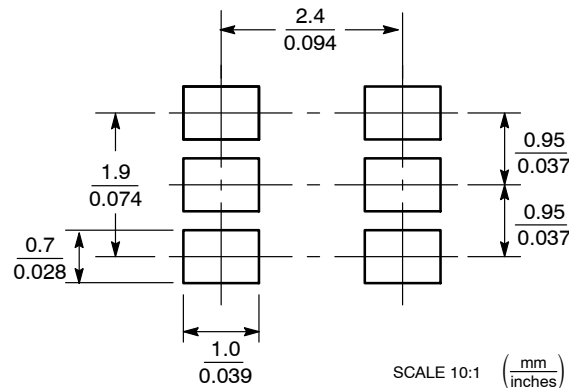

SCALE 10:1 (mm/inches)

\*For additional information on our Pb-Free strategy and soldering details, please download the ON Semiconductor Soldering and Mounting Techniques Reference Manual, SOLDERRM/D.

ON Semiconductor and are registered trademarks of Semiconductor Components Industries, LLC (SCILLC). SCILLC owns the rights to a number of patents, trademarks, copyrights, trade secrets, and other intellectual property. A listing of SCILLC's product/patent coverage may be accessed at [www.onsemi.com/site/pdf/Patent-Marking.pdf](http://www.onsemi.com/site/pdf/Patent-Marking.pdf). SCILLC reserves the right to make changes without further notice to any products herein. SCILLC makes no warranty, representation or guarantee regarding the suitability of its products for any particular purpose, nor does SCILLC assume any liability arising out of the application or use of any product or circuit, and specifically disclaims any and all liability, including without limitation special, consequential or incidental damages. "Typical" parameters which may be provided in SCILLC data sheets and/or specifications can and do vary in different applications and actual performance may vary over time. All operating parameters, including "Typicals" must be validated for each customer application by customer's technical experts. SCILLC does not convey any license under its patent rights nor the rights of others. SCILLC products are not designed, intended, or authorized for use as components in systems intended for surgical implant into the body, or other applications intended to support or sustain life, or for any other application in which the failure of the SCILLC product could create a situation where personal injury or death may occur. Should Buyer purchase or use SCILLC products for any such unintended or unauthorized application, Buyer shall indemnify and hold SCILLC and its officers, employees, subsidiaries, affiliates, and distributors harmless against all claims, costs, damages, and expenses, and reasonable attorney fees arising out of, directly or indirectly, any claim of personal injury or death associated with such unintended or unauthorized use, even if such claim alleges that SCILLC was negligent regarding the design or manufacture of the part. SCILLC is an Equal Opportunity/Affirmative Action Employer. This literature is subject to all applicable copyright laws and is not for resale in any manner.

### PUBLICATION ORDERING INFORMATION

**LITERATURE FULFILLMENT:**  
Literature Distribution Center for ON Semiconductor  
P.O. Box 5163, Denver, Colorado 80217 USA  
**Phone:** 303-675-2175 or 800-344-3860 Toll Free USA/Canada  
**Fax:** 303-675-2176 or 800-344-3867 Toll Free USA/Canada  
**Email:** [orderlit@onsemi.com](mailto:orderlit@onsemi.com)

**N. American Technical Support:** 800-282-9855 Toll Free  
USA/Canada  
**Europe, Middle East and Africa Technical Support:**  
Phone: 421 33 790 2910  
**Japan Customer Focus Center**  
Phone: 81-3-5817-1050

**ON Semiconductor Website:** [www.onsemi.com](http://www.onsemi.com)  
**Order Literature:** <http://www.onsemi.com/orderlit>  
For additional information, please contact your local Sales Representative

## Looking for pricing, stock, or lifecycle information?

Click below to explore more details on WIN SOURCE:

 [View MMBT2131T1 on WIN SOURCE](#)

 [ON Semiconductor](#) Information

## Optimize Your Supply Chain with WIN SOURCE Solutions

-  Global Sourcing Solution
-  Obsolete Management
-  Cost Control Management
-  Shortage Management
-  Alternative Solution
-  Excess Inventory Management