

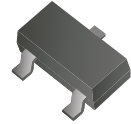

**THE DATASHEET OF
MMBT3904-G**



MMBT3904-G (NPN) RoHS Device



Features

- Epitaxial planar die construction
- As complementary type, the PNP transistor MMBT3904-G is recommended

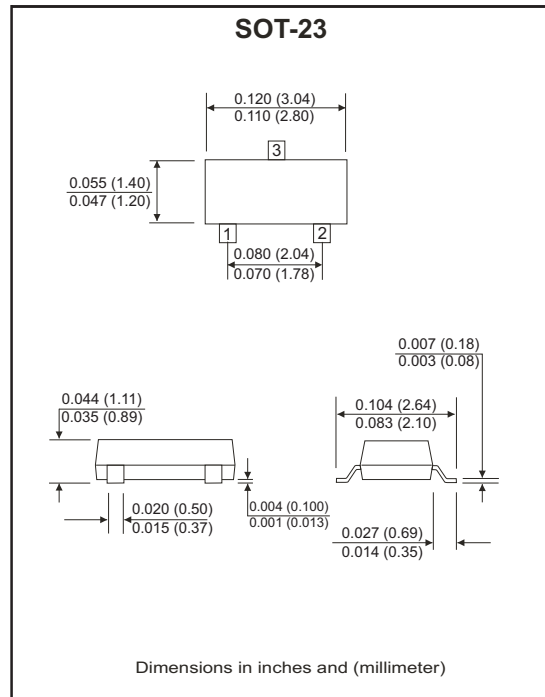
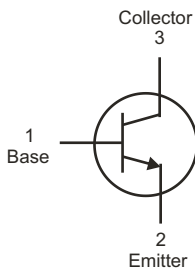

Maximum Ratings (at TA=25°C unless otherwise noted)

Rating	Symbol	Value	Unit
Collector-Emitter Voltage	V_{CE0}	40	Vdc
Collector-Base Voltage	V_{CBO}	60	Vdc
Emitter-Base Voltage	V_{EBO}	6.0	Vdc
Collector Current-Continuous	I_c	200	mAdc

Thermal Characteristics

Characteristics	Symbol	Max. Value	Unit
Total Device Dissipation FR-5 Board (Note) @TA = 25°C	P_D	225	mW
Derate above 25°C		1.8	mW/°C
Thermal Resistance, Junction to Ambient	$R_{\theta JA}$	556	°C/W
Junction and Storage Temperature	T_J, T_{STG}	-55 to +150	°C

Note: FR-5 = 1.0 x 0.75 x 0.062 in.

Electrical Characteristics (at TA=25°C unless otherwise noted)

Characteristics	Conditions	Symbol	Min.	Max.	Unit
OFF CHARACTERISTICS					
Collector-Emitter Breakdown Voltage	Ic =1mA , (Note)	V(BR)CEO	40		V
Collector-Base Breakdown Voltage	Ic =10μA	V(BR)CBO	60		V
Emitter-Base Breakdown Voltage	IE =10μA	V(BR)EBO	6.0		V
Base Cut-off Current	VCE=30V , VEB=3V	IBL		50	nA
Collector Cut-off Current	VCE=30V , VEB=3V	ICEX		50	nA
ON CHARACTERISTICS (Note)					
DC Current Gain	VCE=1V , Ic=0.1mA	hFE	40		
	VCE=1V , Ic=1.0mA		70		
	VCE=1V , Ic=10mA		100	300	
	VCE=1V , Ic=50mA		60		
	VCE=1V , Ic=100mA		30		
Collector-Emitter Saturation Voltage (Note)	Ic=10mA , IB=1.0mA	VCE(sat)		0.2	V
	Ic=50mA , IB=5.0mA			0.3	
Base-Emitter Saturation Voltage (Note)	Ic=10mA , IB=1.0mA	VBE(sat)	0.65	0.85	V
	Ic=50mA , IB=5mA			0.95	
SMALL-SIGNAL CHARACTERISTICS					
Current - Gain - Bandwidth Product	VCE=20V , Ic=10mA , f=100MHz	fT	300		MHZ
Output Capacitance	VCB=5.0V , IE=0 , f=1.0MHz	Cobo		4.0	pF
Input Capacitance	VBE=0.5V , Ic=0 , f=1.0MHz	Cibo		8.0	pF
Input Impedancen	VCE=10V , Ic=1.0mA , f=1.0kHz	hie	1.0	10	kΩ
Voltage Feedback Ratio	VCE=10V , Ic=1.0mA , f=1.0kHz	hre	0.5	8.0	X10 ⁻⁴
Small - Signal Current Gain	VCE=10V , Ic=1.0mA , f=1.0kHz	hfe	100	400	
Output Admittance	VCE=10V , Ic=1.0mA , f=1.0kHz	hoe	1.0	40	μmos
Noise Figure	VCE=5V , Ic=100μA , f=1.0kHz , Rs=1.0kΩ	NF		5.0	dB
SWITCHING CHARACTERISTICS					
Delay Time	VCC=3.0V , VBE=-0.5V	td		35	nS
Rise Time	Ic=10mA , IB1=1.0mA	tr		35	nS
Storage Time	VCC=3.0V ,	ts		200	nS
Fall Time	Ic=10mA , IB1=IB2=1.0mA	tf		50	nS

Note: 1. Pulse Test: Pulse Width ≤ 300μs, Duty Cycle ≤ 2.0%.

Company reserves the right to improve product design , functions and reliability without notice.

REV:E

RATING AND CHARACTERISTIC CURVES (MMBT3904-G)

Fig.1 - ON Voltages

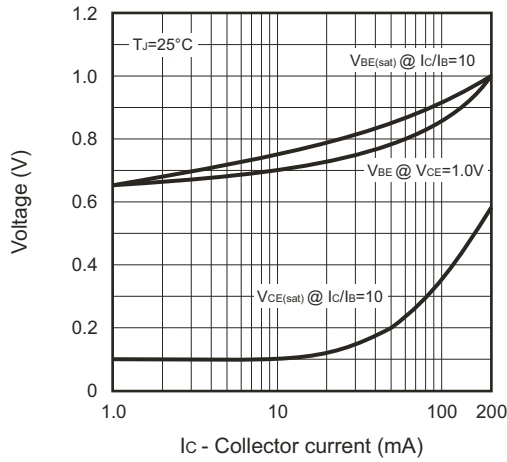

Fig.2 - Temperature Coefficients

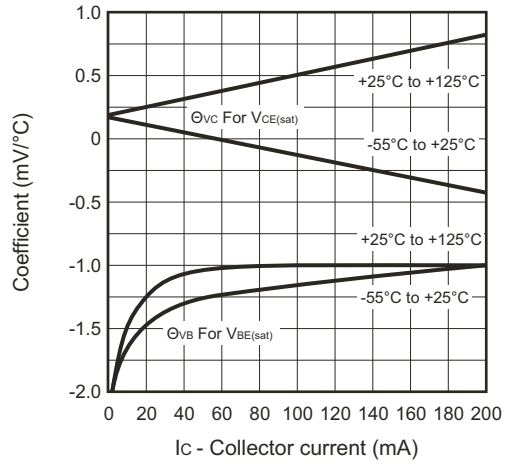

Fig.3 - Turn-On Time

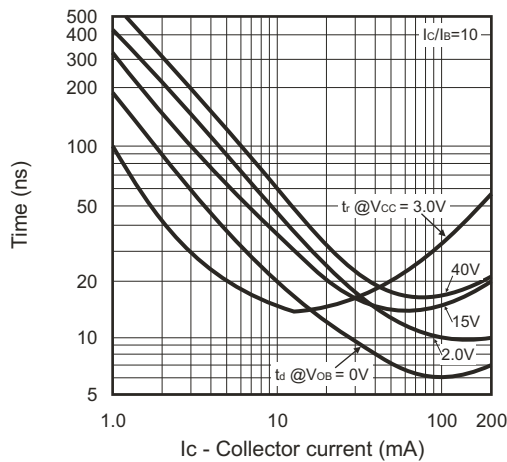

Fig.4 - Rise Time

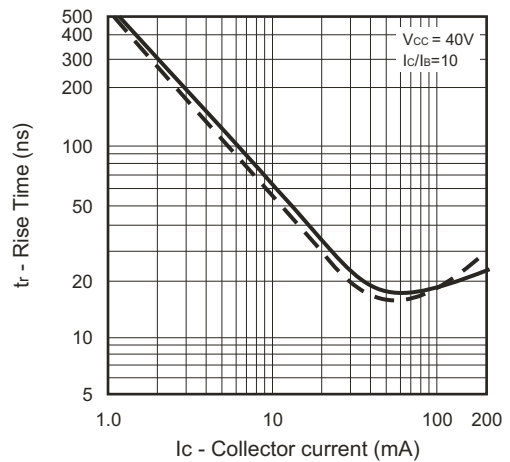

Fig.5 - Collector Saturation Region

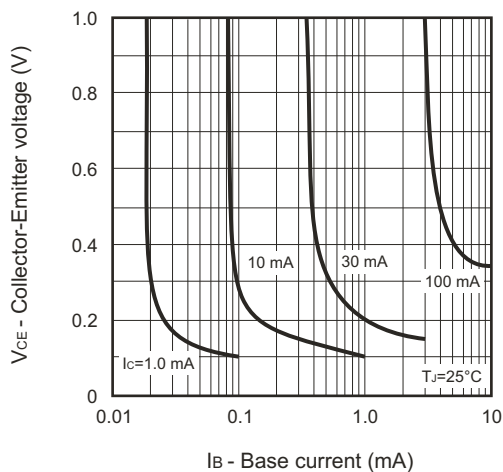
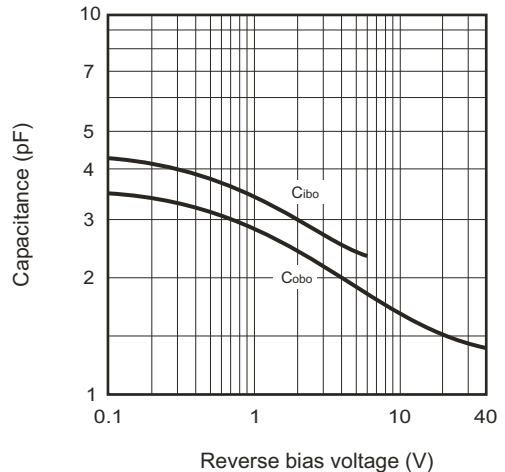
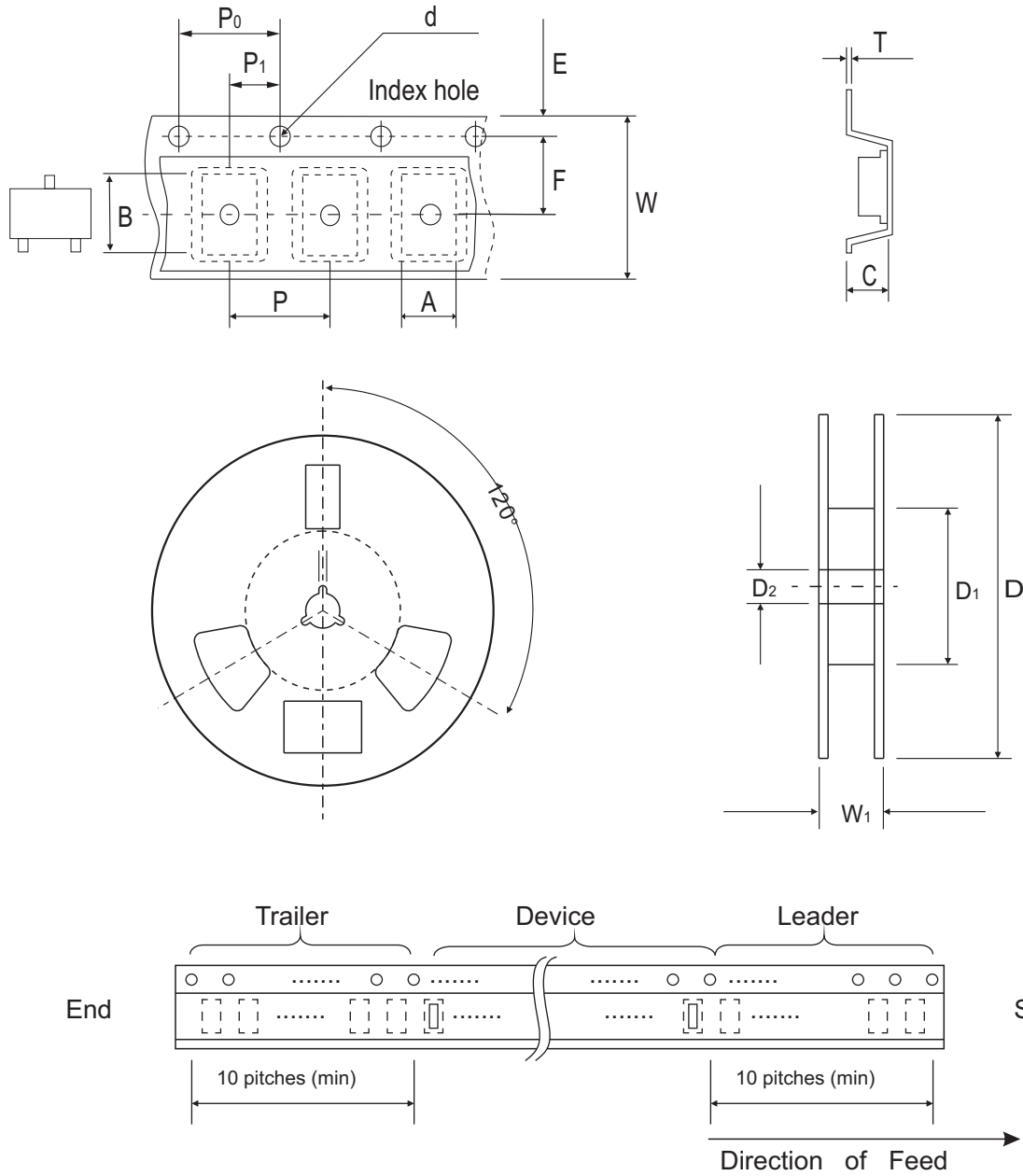

Fig.6 - Capacitance



Company reserves the right to improve product design, functions and reliability without notice.

Reel Taping Specification



SOT-23	SYMBOL	A	B	C	d	D	D ₁	D ₂
	(mm)	3.10 ± 0.10	2.85 ± 0.10	1.40 ± 0.10	1.55 ± 0.10	178 ± 1	50.0 MIN.	13.0 ± 0.20
	(inch)	0.122 ± 0.004	0.112 ± 0.004	0.055 ± 0.004	0.061 ± 0.004	7.008 ± 0.04	1.969 MIN.	0.512 ± 0.008

SOT-23	SYMBOL	E	F	P	P ₀	P ₁	W	W ₁
	(mm)	1.75 ± 0.10	3.50 ± 0.05	4.00 ± 0.10	4.00 ± 0.10	2.00 ± 0.05	8.00 ± 0.30	14.4 MAX.
	(inch)	0.069 ± 0.004	0.138 ± 0.002	0.157 ± 0.004	0.157 ± 0.004	0.079 ± 0.004	0.315 ± 0.008	0.567 MAX.

Marking Code

Part Number	Marking Code	
MMBT3904-G	1AM	1AM Σ

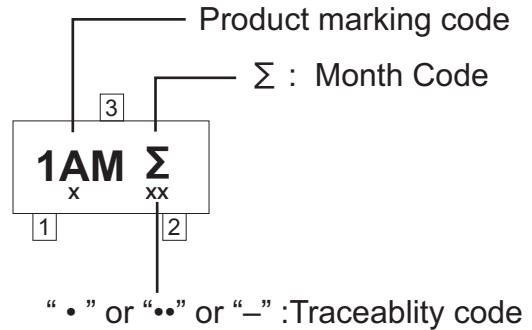

Month Code:

Month	Odd Year (per A.D.)	Even Year (per A.D.)
Jan	1	E
Feb	2	F
Wer	3	H
Apr	4	J
May	5	K
Jun	6	L

Month	Odd Year (per A.D.)	Even Year (per A.D.)
Jul	7	N
Aug	8	P
Sep	9	U
Oct	T	X
Nov	V	Y
Dec	C	Z

Suggested PAD Layout

SIZE	SOT-23	
	(mm)	(inch)
A	0.80	0.031
B	0.90	0.035
C	0.95	0.037
D	2.00	0.079
E	2.90	0.114

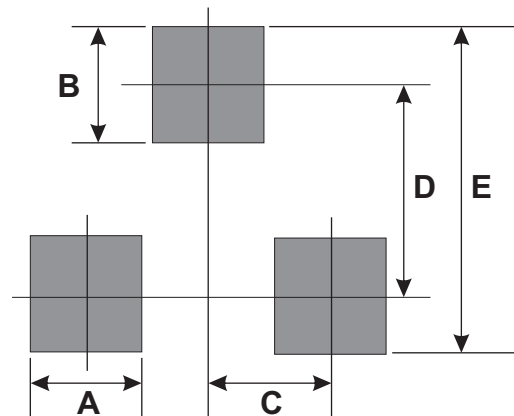

Standard Packaging

Case Type	REEL PACK	
	REEL (pcs)	Reel Size (inch)
SOT-23	3,000	7

Company reserves the right to improve product design , functions and reliability without notice.

Looking for pricing, stock, or lifecycle information?

Click below to explore more details on WIN SOURCE:

- [View MMBT3904-G on WIN SOURCE](#)
- [Comchip Technology Information](#)

Optimize Your Supply Chain with WIN SOURCE Solutions

- ✓ Global Sourcing Solution
- ✓ Obsolete Management
- ✓ Cost Control Management
- ✓ Shortage Management
- ✓ Alternative Solution
- ✓ Excess Inventory Management