



**THE DATASHEET OF
MMSZ4703**



MMSZ4xxxT1G Series, SZMMSZ4xxxT1G Series

Zener Voltage Regulators

500 mW, Low I_{ZT} SOD-123 Surface Mount

Three complete series of Zener diodes are offered in the convenient, surface mount plastic SOD-123 package. These devices provide a convenient alternative to the leadless 34-package style.

Features

- 500 mW Rating on FR-4 or FR-5 Board
- Wide Zener Reverse Voltage Range – 1.8 V to 43 V
- Low Reverse Current (I_{ZT}) – 50 μ A
- Package Designed for Optimal Automated Board Assembly
- Small Package Size for High Density Applications
- ESD Rating of Class 3 (> 16 kV) per Human Body Model
- SZ Prefix for Automotive and Other Applications Requiring Unique Site and Control Change Requirements; AEC-Q101 Qualified and PPAP Capable
- These Devices are Pb-Free and are RoHS Compliant*

Mechanical Characteristics:

CASE: Void-free, transfer-molded, thermosetting plastic case

FINISH: Corrosion resistant finish, easily solderable

MAXIMUM CASE TEMPERATURE FOR SOLDERING PURPOSES:

260°C for 10 Seconds

POLARITY: Cathode indicated by polarity band

FLAMMABILITY RATING: UL 94 V-0

MAXIMUM RATINGS

Rating	Symbol	Max	Units
Total Power Dissipation on FR-5 Board, (Note 1) @ $T_L = 75^\circ\text{C}$ Derated above 75°C	P_D	500 6.7	mW mW/ $^\circ\text{C}$
Thermal Resistance, (Note 2) Junction-to-Ambient	$R_{\theta JA}$	340	$^\circ\text{C}/\text{W}$
Thermal Resistance, (Note 2) Junction-to-Lead	$R_{\theta JL}$	150	$^\circ\text{C}/\text{W}$
Junction and Storage Temperature Range	T_J, T_{stg}	-55 to +150	$^\circ\text{C}$

Stresses exceeding those listed in the Maximum Ratings table may damage the device. If any of these limits are exceeded, device functionality should not be assumed, damage may occur and reliability may be affected.

1. FR-5 = 3.5 X 1.5 inches, using the minimum recommended footprint.
2. Thermal Resistance measurement obtained via infrared Scan Method.

*For additional information on our Pb-Free strategy and soldering details, please download the ON Semiconductor Soldering and Mounting Techniques Reference Manual, SOLDERRM/D.



ON Semiconductor®

www.onsemi.com



SOD-123
CASE 425
STYLE 1

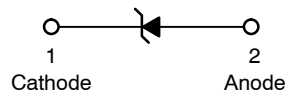

MARKING DIAGRAM

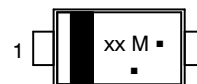

- xx = Device Code (Refer to page 3)
- M = Date Code
- = Pb-Free Package

(Note: Microdot may be in either location)

ORDERING INFORMATION

Device	Package	Shipping†
MMSZ4xxxT1G	SOD-123 (Pb-Free)	3,000 / Tape & Reel
SZMMSZ4xxxT1G	SOD-123 (Pb-Free)	3,000 / Tape & Reel
MMSZ4xxxT3G	SOD-123 (Pb-Free)	10,000 / Tape & Reel
SZMMSZ4xxxT3G	SOD-123 (Pb-Free)	10,000 / Tape & Reel

†For information on tape and reel specifications, including part orientation and tape sizes, please refer to our Tape and Reel Packaging Specifications Brochure, BRD8011/D.

DEVICE MARKING INFORMATION

See specific marking information in the device marking column of the Electrical Characteristics table on page 3 of this data sheet.

MMSZ4xxxT1G Series, SZMMSZ4xxxT1G Series

ELECTRICAL CHARACTERISTICS ($T_A = 25^\circ\text{C}$ unless otherwise noted, $V_F = 0.9\text{ V Max. @ } I_F = 10\text{ mA}$)

Symbol	Parameter
V_Z	Reverse Zener Voltage @ I_{ZT}
I_{ZT}	Reverse Current
I_R	Reverse Leakage Current @ V_R
V_R	Reverse Voltage
I_F	Forward Current
V_F	Forward Voltage @ I_F

Product parametric performance is indicated in the Electrical Characteristics for the listed test conditions, unless otherwise noted. Product performance may not be indicated by the Electrical Characteristics if operated under different conditions.



MMSZ4xxxT1G Series, SZMMSZ4xxxT1G Series

ELECTRICAL CHARACTERISTICS ($T_A = 25^\circ\text{C}$ unless otherwise noted, $V_F = 0.9\text{ V Max.}$ @ $I_F = 10\text{ mA}$)

Device*	Device Marking	Zener Voltage (Note 3)				Leakage Current	
		V _Z (Volts)			@ I _{ZT}	I _R @ V _R	
		Min	Nom	Max	μA	μA	Volts
MMSZ4678T1G	CC	1.71	1.8	1.89	50	7.5	1
MMSZ4679T1G	CD	1.90	2.0	2.10	50	5	1
MMSZ4680T1G	CE	2.09	2.2	2.31	50	4	1
MMSZ4681T1G	CF	2.28	2.4	2.52	50	2	1
MMSZ4682T1G	CH	2.565	2.7	2.835	50	1	1
MMSZ4683T1G	CJ	2.85	3.0	3.15	50	0.8	1
MMSZ4684T1G	CK	3.13	3.3	3.47	50	7.5	1.5
MMSZ4685T1G	CM	3.42	3.6	3.78	50	7.5	2
MMSZ4686T1G	CN	3.70	3.9	4.10	50	5	2
MMSZ4687T1G	CP	4.09	4.3	4.52	50	4	2
SZMMSZ4687T1G	CG6	4.09	4.3	4.52	50	4	2
MMSZ4688T1G	CT	4.47	4.7	4.94	50	10	3
MMSZ4689T1G	CU	4.85	5.1	5.36	50	10	3
MMSZ4690T1G/T3G	CV	5.32	5.6	5.88	50	10	4
MMSZ4691T1G	CA	5.89	6.2	6.51	50	10	5
MMSZ4692T1G	CX	6.46	6.8	7.14	50	10	5.1
MMSZ4693T1G	CY	7.13	7.5	7.88	50	10	5.7
MMSZ4694T1G	CZ	7.79	8.2	8.61	50	1	6.2
MMSZ4695T1G	DC	8.27	8.7	9.14	50	1	6.6
MMSZ4696T1G	DD	8.65	9.1	9.56	50	1	6.9
MMSZ4697T1G	DE	9.50	10	10.50	50	1	7.6
MMSZ4698T1G	DF	10.45	11	11.55	50	0.05	8.4
MMSZ4699T1G	DH	11.40	12	12.60	50	0.05	9.1
MMSZ4700T1G	DJ	12.35	13	13.65	50	0.05	9.8
MMSZ4701T1G	DK	13.30	14	14.70	50	0.05	10.6
MMSZ4702T1G	DM	14.25	15	15.75	50	0.05	11.4
MMSZ4703T1G †	DN	15.20	16	16.80	50	0.05	12.1
MMSZ4704T1G	DP	16.15	17	17.85	50	0.05	12.9
MMSZ4705T1G	DT	17.10	18	18.90	50	0.05	13.6
MMSZ4706T1G	DU	18.05	19	19.95	50	0.05	14.4
MMSZ4707T1G	DV	19.00	20	21.00	50	0.01	15.2
MMSZ4708T1G	DA	20.90	22	23.10	50	0.01	16.7
MMSZ4709T1G	DX	22.80	24	25.20	50	0.01	18.2
MMSZ4710T1G	DY	23.75	25	26.25	50	0.01	19.0
MMSZ4711T1G †	EA	25.65	27	28.35	50	0.01	20.4
MMSZ4712T1G	EC	26.60	28	29.40	50	0.01	21.2
MMSZ4713T1G	ED	28.50	30	31.50	50	0.01	22.8
MMSZ4714T1G	EE	31.35	33	34.65	50	0.01	25.0
MMSZ4715T1G	EF	34.20	36	37.80	50	0.01	27.3
MMSZ4716T1G	EH	37.05	39	40.95	50	0.01	29.6
MMSZ4717T1G	EJ	40.85	43	45.15	50	0.01	32.6

3. Nominal Zener voltage is measured with the device junction in thermal equilibrium at $T_L = 30^\circ\text{C} \pm 1^\circ\text{C}$.

*Include SZ-prefix devices where applicable.

†MMSZ4703 and MMSZ4711 Not Available in 10,000/Tape & Reel

TYPICAL CHARACTERISTICS



Figure 1. Temperature Coefficients (Temperature Range -55°C to +150°C)



Figure 2. Temperature Coefficients (Temperature Range -55°C to +150°C)



Figure 3. Steady State Power Derating



Figure 4. Maximum Nonrepetitive Surge Power



Figure 5. Effect of Zener Voltage on Zener Impedance

TYPICAL CHARACTERISTICS

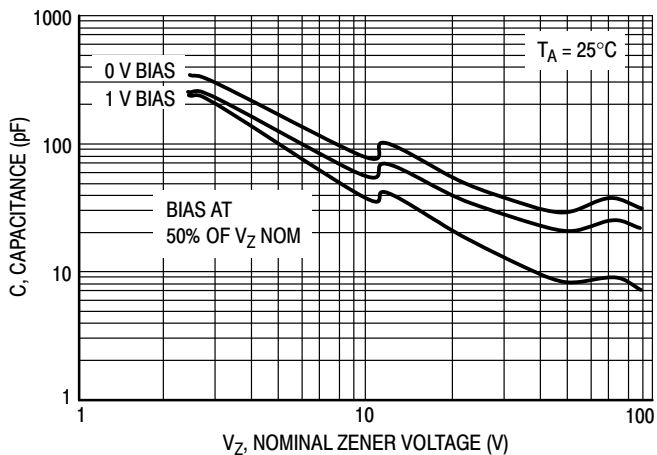

Figure 6. Typical Capacitance

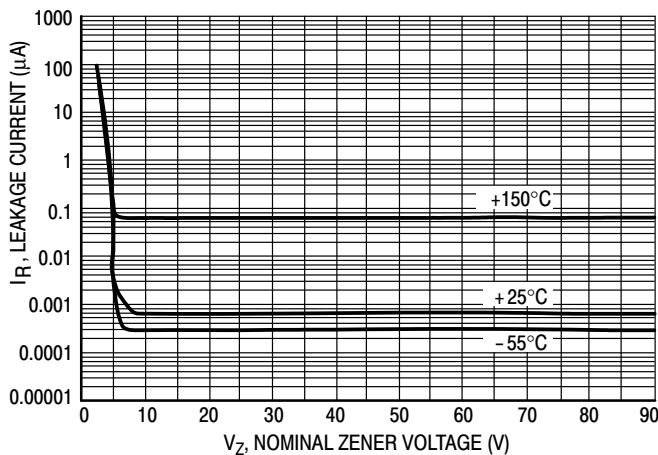

Figure 7. Typical Leakage Current

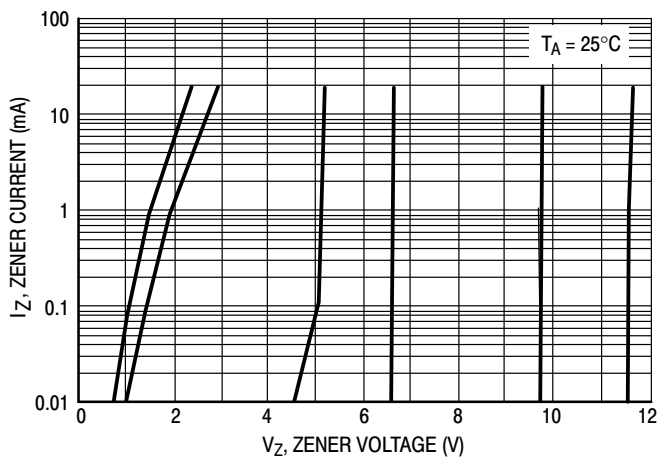

Figure 8. Zener Voltage versus Zener Current
(V_Z Up to 12 V)

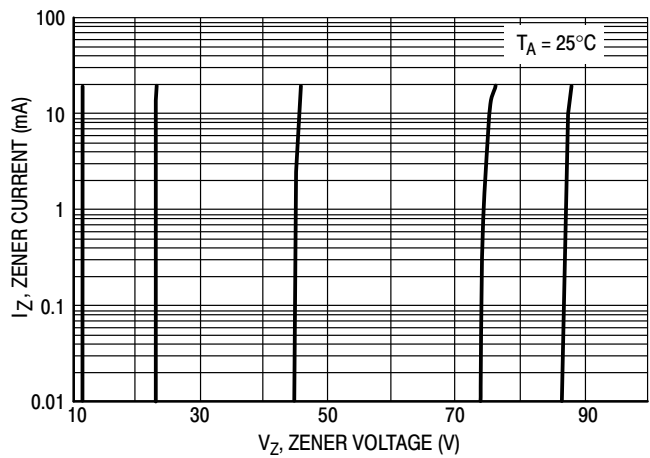

Figure 9. Zener Voltage versus Zener Current
(12 V to 91 V)

MECHANICAL CASE OUTLINE

PACKAGE DIMENSIONS

ON Semiconductor®



SCALE 5:1

SOD-123
CASE 425-04
ISSUE G

DATE 07 OCT 2009

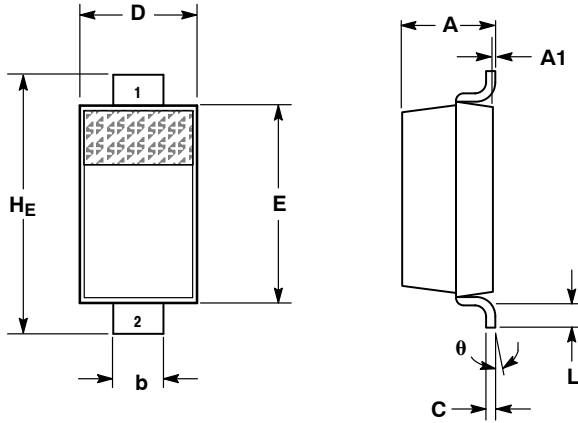

- NOTES:
1. DIMENSIONING AND TOLERANCING PER ANSI Y14.5M, 1982.
2. CONTROLLING DIMENSION: INCH.

DIM	MILLIMETERS			INCHES		
	MIN	NOM	MAX	MIN	NOM	MAX
A	0.94	1.17	1.35	0.037	0.046	0.053
A1	0.00	0.05	0.10	0.000	0.002	0.004
b	0.51	0.61	0.71	0.020	0.024	0.028
c	---	---	0.15	---	---	0.006
D	1.40	1.60	1.80	0.055	0.063	0.071
E	2.54	2.69	2.84	0.100	0.106	0.112
HE	3.56	3.68	3.86	0.140	0.145	0.152
L	0.25	---	---	0.010	---	---
θ	0°	---	10°	0°	---	10°

GENERIC MARKING DIAGRAM*



- XXX = Specific Device Code
 - M = Date Code
 - = Pb-Free Package
- (Note: Microdot may be in either location)

*This information is generic. Please refer to device data sheet for actual part marking. Pb-Free indicator, "G" or microdot "■", may or may not be present.

STYLE 1:
PIN 1. CATHODE
2. ANODE

SOLDERING FOOTPRINT*



SCALE 10:1 (mm/inches)

*For additional information on our Pb-Free strategy and soldering details, please download the ON Semiconductor Soldering and Mounting Techniques Reference Manual, SOLDERRM/D.

DOCUMENT NUMBER:	98ASB42927B	Electronic versions are uncontrolled except when accessed directly from the Document Repository. Printed versions are uncontrolled except when stamped "CONTROLLED COPY" in red.
STATUS:	ON SEMICONDUCTOR STANDARD	
NEW STANDARD:		
DESCRIPTION:	SOD-123	PAGE 1 OF 2

ON Semiconductor and  are trademarks of Semiconductor Components Industries, LLC dba ON Semiconductor or its subsidiaries in the United States and/or other countries. ON Semiconductor owns the rights to a number of patents, trademarks, copyrights, trade secrets, and other intellectual property. A listing of ON Semiconductor's product/patent coverage may be accessed at www.onsemi.com/site/pdf/Patent-Marking.pdf. ON Semiconductor reserves the right to make changes without further notice to any products herein. ON Semiconductor makes no warranty, representation or guarantee regarding the suitability of its products for any particular purpose, nor does ON Semiconductor assume any liability arising out of the application or use of any product or circuit, and specifically disclaims any and all liability, including without limitation special, consequential or incidental damages. Buyer is responsible for its products and applications using ON Semiconductor products, including compliance with all laws, regulations and safety requirements or standards, regardless of any support or applications information provided by ON Semiconductor. "Typical" parameters which may be provided in ON Semiconductor data sheets and/or specifications can and do vary in different applications and actual performance may vary over time. All operating parameters, including "Typicals" must be validated for each customer application by customer's technical experts. ON Semiconductor does not convey any license under its patent rights nor the rights of others. ON Semiconductor products are not designed, intended, or authorized for use as a critical component in life support systems or any FDA Class 3 medical devices or medical devices with a same or similar classification in a foreign jurisdiction or any devices intended for implantation in the human body. Should Buyer purchase or use ON Semiconductor products for any such unintended or unauthorized application, Buyer shall indemnify and hold ON Semiconductor and its officers, employees, subsidiaries, affiliates, and distributors harmless against all claims, costs, damages, and expenses, and reasonable attorney fees arising out of, directly or indirectly, any claim of personal injury or death associated with such unintended or unauthorized use, even if such claim alleges that ON Semiconductor was negligent regarding the design or manufacture of the part. ON Semiconductor is an Equal Opportunity/Affirmative Action Employer. This literature is subject to all applicable copyright laws and is not for resale in any manner.

PUBLICATION ORDERING INFORMATION

LITERATURE FULFILLMENT:

Literature Distribution Center for ON Semiconductor
19521 E. 32nd Pkwy, Aurora, Colorado 80011 USA
Phone: 303-675-2175 or 800-344-3860 Toll Free USA/Canada
Fax: 303-675-2176 or 800-344-3867 Toll Free USA/Canada
Email: orderlit@onsemi.com

N. American Technical Support: 800-282-9855 Toll Free
USA/Canada
Europe, Middle East and Africa Technical Support:
Phone: 421 33 790 2910



ON Semiconductor Website: www.onsemi.com

Order Literature: <http://www.onsemi.com/orderlit>

For additional information, please contact your local
Sales Representative

Looking for pricing, stock, or lifecycle information?

Click below to explore more details on WIN SOURCE:

-  [View MMSZ4703 on WIN SOURCE](#)
-  [Fairchild/ON Semiconductor](#) Information

Optimize Your Supply Chain with WIN SOURCE Solutions

-  Global Sourcing Solution
-  Obsolete Management
-  Cost Control Management
-  Shortage Management
-  Alternative Solution
-  Excess Inventory Management