



**THE DATASHEET OF  
MMZ1005Y152CT000**



Chip beads  
For general signal line  
MMZ series



# MMZ1005 type



## FEATURES

- Noise reduction solution for general signal line.
- Various frequency characteristics with 5 materials of different features for countermeasures against everything from general signals to high-speed signals.
- Operating temperature range: -55 to +125°C

## APPLICATION

- Noise removal for mobile devices such as smartphones and tablet terminals, and various modules.
- Noise removal for PCs and recorders, household appliances such as STBs, smart grids, and industrial equipment.

## PART NUMBER CONSTRUCTION

MMZ	1005	S	800	C	T	000
Series name	LxWxT dimensions 1.0x0.5x0.5 mm	Material name	Impedance ( $\Omega$ ) at 100MHz	Characteristic type	Packaging style	Internal code

## CHARACTERISTICS SPECIFICATION TABLE

Impedance [100MHz] ( $\Omega$ )	Tolerance	DC resistance ( $\Omega$ )max.	Rated current (mA)max.	Part No.
80	±25%	0.19	450	<a href="#">MMZ1005B800CT000</a>
120	±25%	0.25	400	<a href="#">MMZ1005B121CT000</a>
600	±25%	0.85	200	<a href="#">MMZ1005B601CT000</a>
80	±25%	0.12	500	<a href="#">MMZ1005S800CT000</a>
120	±25%	0.22	500	<a href="#">MMZ1005S121CT000</a>
240	±25%	0.28	400	<a href="#">MMZ1005S241CT000</a>
600	±25%	0.52	300	<a href="#">MMZ1005S601CT000</a>
1000	±25%	0.75	200	<a href="#">MMZ1005S102CT000</a>
40	±25%	0.10	550	<a href="#">MMZ1005Y400CT000</a>
80	±25%	0.17	450	<a href="#">MMZ1005Y800CT000</a>
120	±25%	0.18	400	<a href="#">MMZ1005Y121CT000</a>
240	±25%	0.26	300	<a href="#">MMZ1005Y241CT000</a>
300	±25%	0.38	250	<a href="#">MMZ1005Y301CT000</a>
470	±25%	0.47	250	<a href="#">MMZ1005Y471CT000</a>
600	±25%	0.54	250	<a href="#">MMZ1005Y601CT000</a>
1000	±25%	0.70	200	<a href="#">MMZ1005Y102CT000</a>
1500	±25%	1.00	100	<a href="#">MMZ1005Y152CT000</a>
1800	±25%	0.85	150	<a href="#">MMZ1005Y182CT000</a>

### Measurement equipment

Measurement item	Product No.	Manufacturer
Impedance	E4991A+16192A	Keysight Technologies
DC resistance	Type-7556	Yokogawa

\* Equivalent measurement equipment may be used.



# MMZ1005 type

## CHARACTERISTICS SPECIFICATION TABLE

Impedance [100MHz] ( $\Omega$ )		DC resistance ( $\Omega$ )max.	Rated current (mA)max.	Part No.
	Tolerance			
10	$\pm 5\Omega$	0.10	500	<a href="#">MMZ1005D100CT000</a>
22	$\pm 25\%$	0.17	400	<a href="#">MMZ1005D220CT000</a>
33	$\pm 25\%$	0.24	400	<a href="#">MMZ1005D330CT000</a>
68	$\pm 25\%$	0.38	400	<a href="#">MMZ1005D680CT000</a>
120	$\pm 25\%$	0.60	350	<a href="#">MMZ1005D121CT000</a>
240	$\pm 25\%$	0.90	200	<a href="#">MMZ1005D241CT000</a>
33	$\pm 25\%$	0.50	200	<a href="#">MMZ1005F330CT000</a>
47	$\pm 25\%$	0.60	100	<a href="#">MMZ1005F470CT000</a>
56	$\pm 25\%$	0.70	100	<a href="#">MMZ1005F560CT000</a>

### Measurement equipment

Measurement item	Product No.	Manufacturer
Impedance	E4991A+16192A	Keysight Technologies
DC resistance	Type-7556	Yokogawa

\* Equivalent measurement equipment may be used.

# MMZ1005 type

## Z VS. FREQUENCY CHARACTERISTICS (BY SERIES)

**MMZ1005B series**

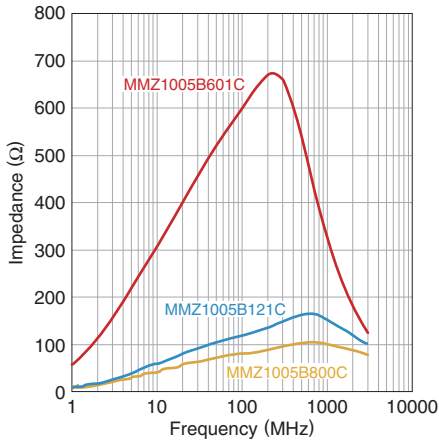

**MMZ1005S series**

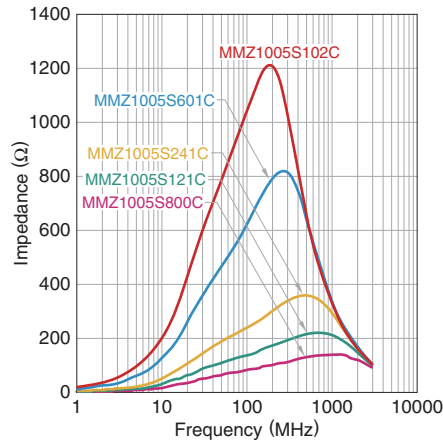

**MMZ1005Y series**

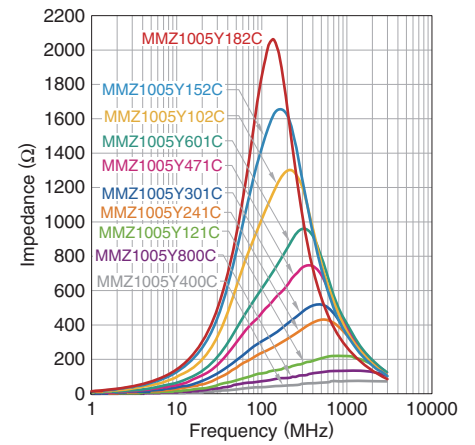

**MMZ1005D series**

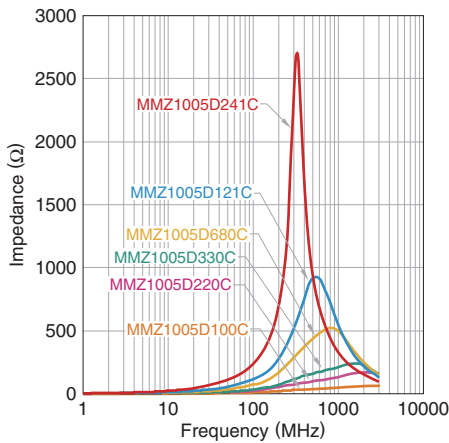

**MMZ1005F series**

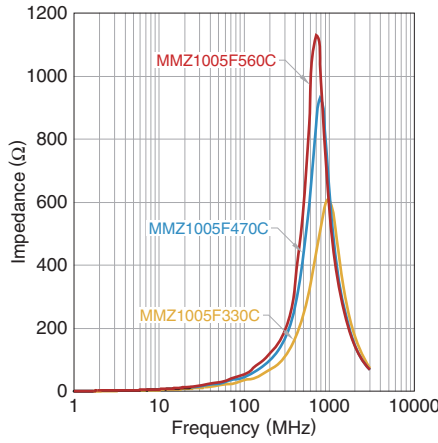

# MMZ1005 type

## Z, X, R VS. FREQUENCY CHARACTERISTICS

MMZ1005B800CT000



MMZ1005B121CT000

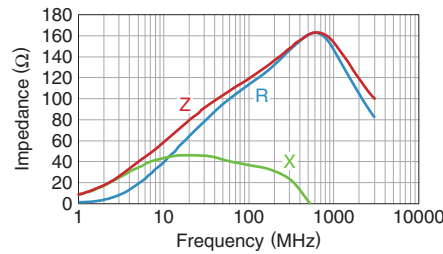

MMZ1005B601CT000

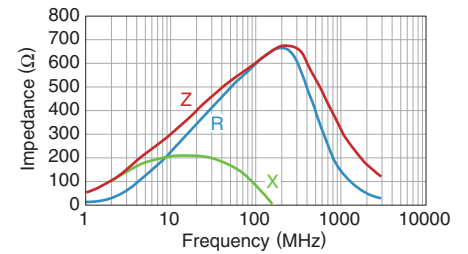

MMZ1005S800CT000

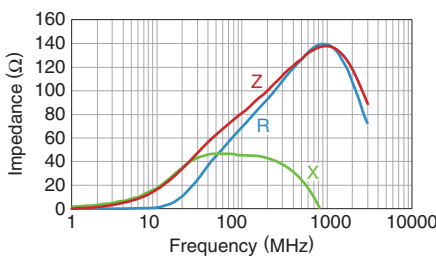

MMZ1005S121CT000

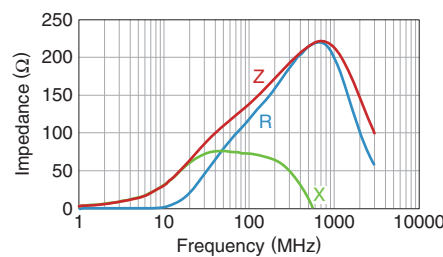

MMZ1005S241CT000



MMZ1005S601CT000

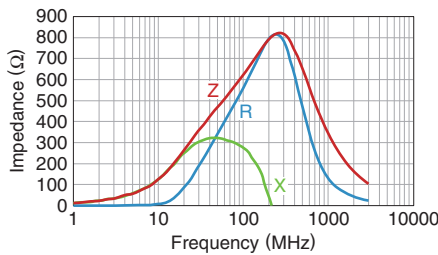

MMZ1005S102CT000

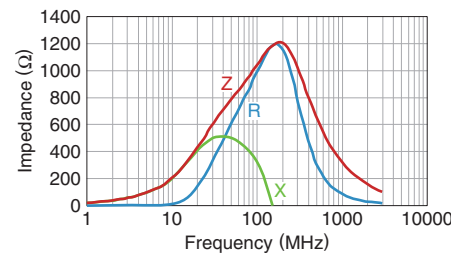

MMZ1005Y400CT000



MMZ1005Y800CT000

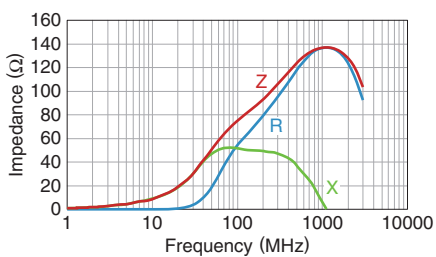

MMZ1005Y121CT000

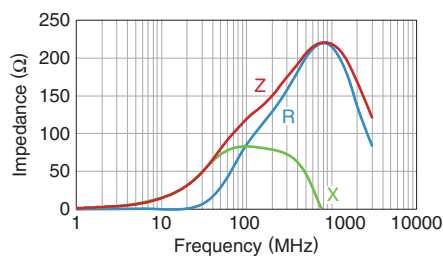

MMZ1005Y241CT000



MMZ1005Y301CT000

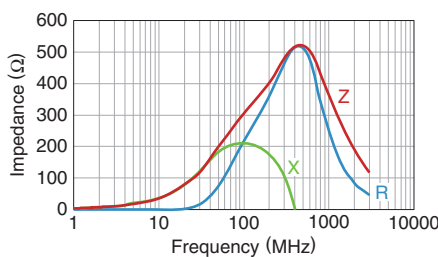

MMZ1005Y471CT000

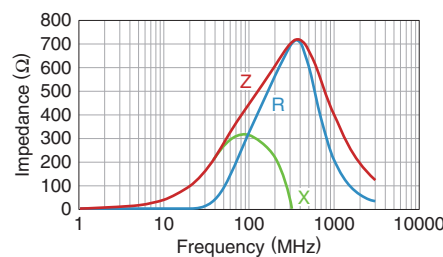

MMZ1005Y601CT000

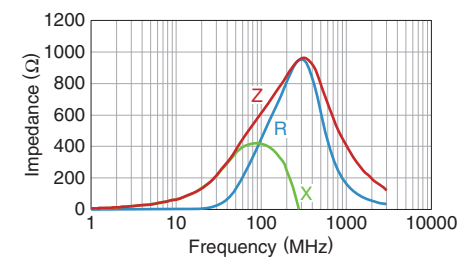

# MMZ1005 type

## Z, X, R VS. FREQUENCY CHARACTERISTICS

MMZ1005Y102CT000

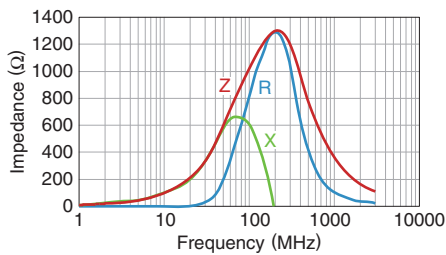

MMZ1005Y152CT000

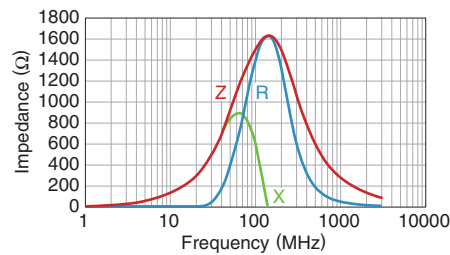

MMZ1005Y182CT000

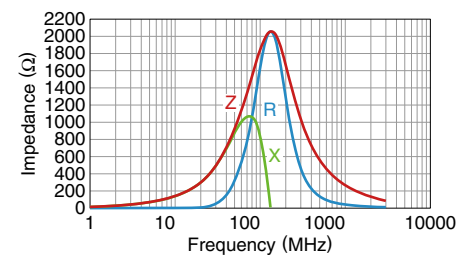

MMZ1005D100CT000

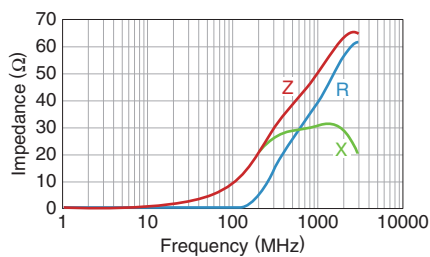

MMZ1005D220CT000

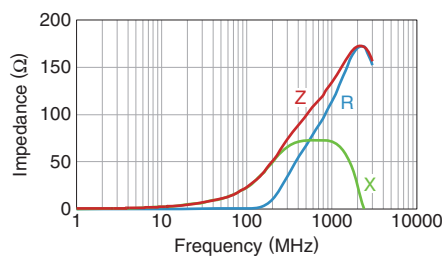

MMZ1005D330CT000

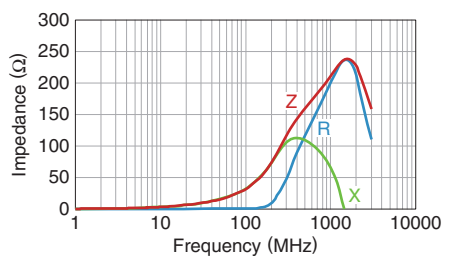

MMZ1005D680CT000

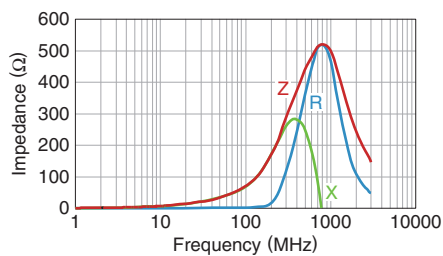

MMZ1005D121CT000

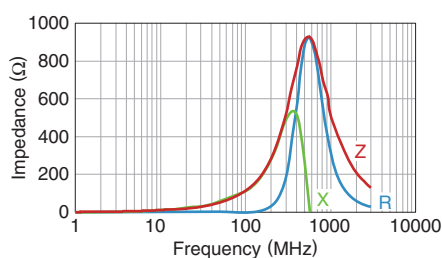

MMZ1005D241CT000

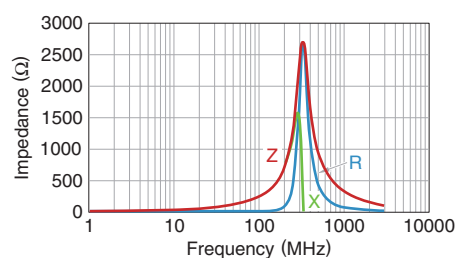

MMZ1005F330CT000

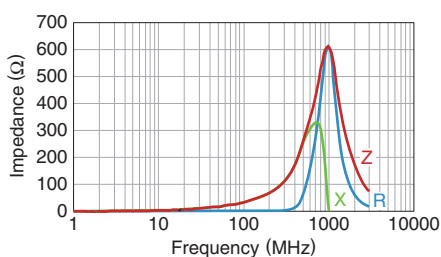

MMZ1005F470CT000

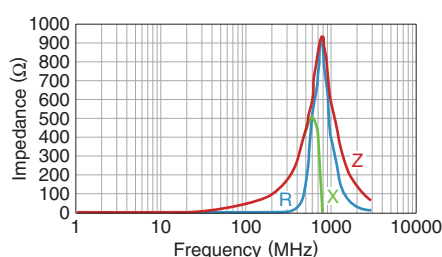

MMZ1005F560CT000

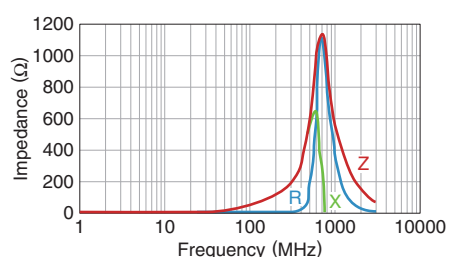

# MMZ1005 type

## SHAPE & DIMENSIONS

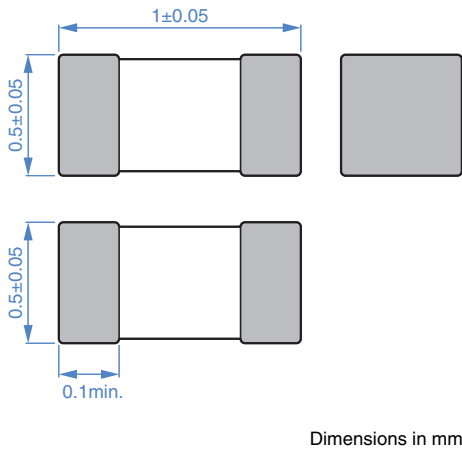

## PACKAGING STYLE

### REEL DIMENSIONS

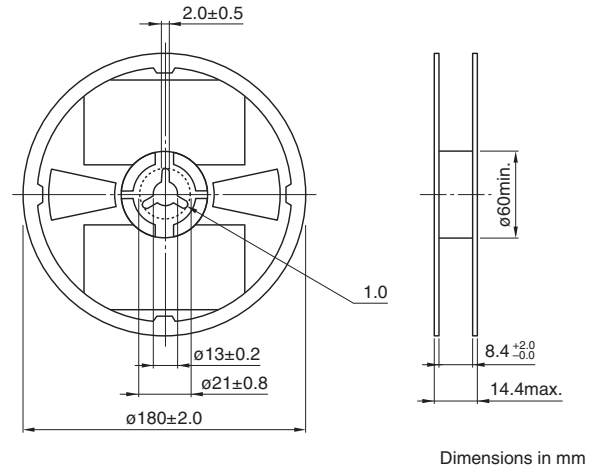

## RECOMMENDED LAND PATTERN



### TAPE DIMENSIONS

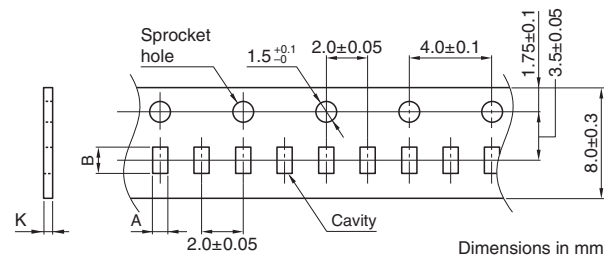

## RECOMMENDED REFLOW PROFILE

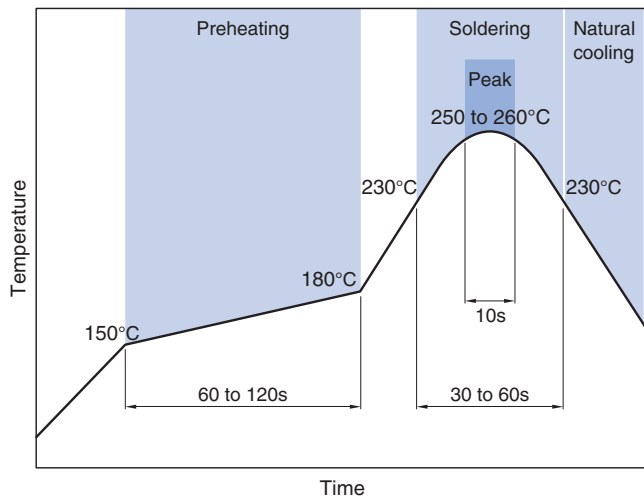

Type	A	B	K
MMZ1005	0.65±0.1	1.15±0.1	0.8max.

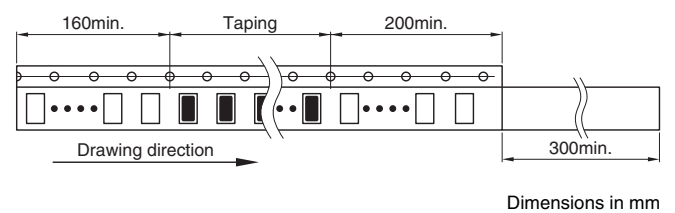

### PACKAGE QUANTITY

Package quantity	10,000 pcs/reel
------------------	-----------------

## TEMPERATURE RANGE, INDIVIDUAL WEIGHT

Operating temperature range	Storage temperature range*	Individual weight
-55 to +125°C	-55 to +125°C	1 mg

\* The storage temperature range is for after the assembly.

## REMINDERS FOR USING THESE PRODUCTS

Before using these products, be sure to request the delivery specifications.

### SAFETY REMINDERS

Please pay sufficient attention to the warnings for safe designing when using this products.

#### REMINDERS

- The storage period is within 12 months. Be sure to follow the storage conditions (temperature: 5 to 40°C, humidity: 10 to 75% RH or less).  
If the storage period elapses, the soldering of the terminal electrodes may deteriorate.
- Do not use or store in locations where there are conditions such as gas corrosion (salt, acid, alkali, etc.).
- Before soldering, be sure to preheat components.  
The preheating temperature should be set so that the temperature difference between the solder temperature and chip temperature does not exceed 150°C.
- Soldering corrections after mounting should be within the range of the conditions determined in the specifications.  
If overheated, a short circuit, performance deterioration, or lifespan shortening may occur.
- When embedding a printed circuit board where a chip is mounted to a set, be sure that residual stress is not given to the chip due to the overall distortion of the printed circuit board and partial distortion such as at screw tightening portions.
- Self heating (temperature increase) occurs when the power is turned ON, so the tolerance should be sufficient for the set thermal design.
- Carefully lay out the coil for the circuit board design of the non-magnetic shield type.  
A malfunction may occur due to magnetic interference.
- Use a wrist band to discharge static electricity in your body through the grounding wire.
- Do not expose the products to magnets or magnetic fields.
- Do not use for a purpose outside of the contents regulated in the delivery specifications.
- The products listed on this catalog are intended for use in general electronic equipment (AV equipment, telecommunications equipment, home appliances, amusement equipment, computer equipment, personal equipment, office equipment, measurement equipment, industrial robots) under a normal operation and use condition.  
The products are not designed or warranted to meet the requirements of the applications listed below, whose performance and/or quality require a more stringent level of safety or reliability, or whose failure, malfunction or trouble could cause serious damage to society, person or property.  
If you intend to use the products in the applications listed below or if you have special requirements exceeding the range or conditions set forth in the each catalog, please contact us.



- (1) Aerospace/aviation equipment
- (2) Transportation equipment (cars, electric trains, ships, etc.)
- (3) Medical equipment
- (4) Power-generation control equipment
- (5) Atomic energy-related equipment
- (6) Seabed equipment
- (7) Transportation control equipment

- (8) Public information-processing equipment
- (9) Military equipment
- (10) Electric heating apparatus, burning equipment
- (11) Disaster prevention/crime prevention equipment
- (12) Safety equipment
- (13) Other applications that are not considered general-purpose applications

When designing your equipment even for general-purpose applications, you are kindly requested to take into consideration securing protection circuit/device or providing backup circuits in your equipment.

## Looking for pricing, stock, or lifecycle information?

Click below to explore more details on WIN SOURCE:

-  [View MMZ1005Y152CT000 on WIN SOURCE](#)
-  [TDK Corporation](#) Information

## Optimize Your Supply Chain with WIN SOURCE Solutions

-  Global Sourcing Solution
-  Obsolete Management
-  Cost Control Management
-  Shortage Management
-  Alternative Solution
-  Excess Inventory Management