



Is Now Part of



ON Semiconductor®

To learn more about ON Semiconductor, please visit our website at
www.onsemi.com

Please note: As part of the Fairchild Semiconductor integration, some of the Fairchild orderable part numbers will need to change in order to meet ON Semiconductor's system requirements. Since the ON Semiconductor product management systems do not have the ability to manage part nomenclature that utilizes an underscore (_), the underscore (_) in the Fairchild part numbers will be changed to a dash (-). This document may contain device numbers with an underscore (_). Please check the ON Semiconductor website to verify the updated device numbers. The most current and up-to-date ordering information can be found at www.onsemi.com. Please email any questions regarding the system integration to Fairchild_questions@onsemi.com.

ON Semiconductor and the ON Semiconductor logo are trademarks of Semiconductor Components Industries, LLC dba ON Semiconductor or its subsidiaries in the United States and/or other countries. ON Semiconductor owns the rights to a number of patents, trademarks, copyrights, trade secrets, and other intellectual property. A listing of ON Semiconductor's product/patent coverage may be accessed at www.onsemi.com/site/pdf/Patent-Marking.pdf. ON Semiconductor reserves the right to make changes without further notice to any products herein. ON Semiconductor makes no warranty, representation or guarantee regarding the suitability of its products for any particular purpose, nor does ON Semiconductor assume any liability arising out of the application or use of any product or circuit, and specifically disclaims any and all liability, including without limitation special, consequential or incidental damages. Buyer is responsible for its products and applications using ON Semiconductor products, including compliance with all laws, regulations and safety requirements or standards, regardless of any support or applications information provided by ON Semiconductor. "Typical" parameters which may be provided in ON Semiconductor data sheets and/or specifications can and do vary in different applications and actual performance may vary over time. All operating parameters, including "Typicals" must be validated for each customer application by customer's technical experts. ON Semiconductor does not convey any license under its patent rights nor the rights of others. ON Semiconductor products are not designed, intended, or authorized for use as a critical component in life support systems or any FDA Class 3 medical devices or medical devices with a same or similar classification in a foreign jurisdiction or any devices intended for implantation in the human body. Should Buyer purchase or use ON Semiconductor products for any such unintended or unauthorized application, Buyer shall indemnify and hold ON Semiconductor and its officers, employees, subsidiaries, affiliates, and distributors harmless against all claims, costs, damages, and expenses, and reasonable attorney fees arising out of, directly or indirectly, any claim of personal injury or death associated with such unintended or unauthorized use, even if such claim alleges that ON Semiconductor was negligent regarding the design or manufacture of the part. ON Semiconductor is an Equal Opportunity/Affirmative Action Employer. This literature is subject to all applicable copyright laws and is not for resale in any manner.



August 2015

MOC205M, MOC206M, MOC207M, MOC211M, MOC212M, MOC213M, MOC216M, MOC217M 8-pin SOIC Single-Channel Phototransistor Output Optocoupler

Features

- Closely Matched Current Transfer Ratios
- Minimum BV_{CEO} of 70 V Guaranteed
 - MOC205M, MOC206M, MOC207M
- Minimum BV_{CEO} of 30 V Guaranteed
 - MOC211M, MOC212M, MOC213M, MOC216M, MOC217M
- Low LED Input Current Required for Easier Logic Interfacing
 - MOC216M, MOC217M
- Convenient Plastic SOIC-8 Surface Mountable Package Style, with 0.050" Lead Spacing
- Safety and Regulatory Approvals:
 - UL1577, 2,500 VAC_{RMS} for 1 Minute
 - DIN-EN/IEC60747-5-5, 565 V Peak Working Insulation Voltage

Applications

- Feedback Control Circuits
- Interfacing and Coupling Systems of Different Potentials and Impedances
- General Purpose Switching Circuits
- Monitor and Detection Circuits

Description

These devices consist of a gallium arsenide infrared emitting diode optically coupled to a monolithic silicon phototransistor detector, in a surface mountable, small outline, plastic package. They are ideally suited for high-density applications, and eliminate the need for through-the-board mounting.

Schematic

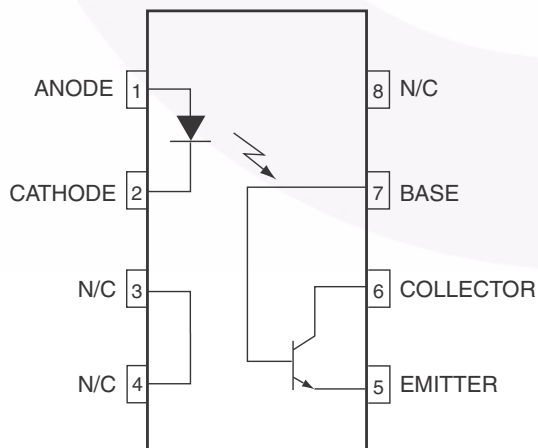

Figure 1. Schematic

Package Outline

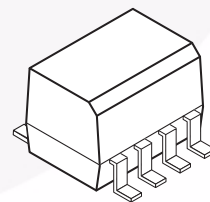

Figure 2. Package Outline

Safety and Insulation Ratings

As per DIN EN/IEC 60747-5-5, this optocoupler is suitable for “safe electrical insulation” only within the safety limit data. Compliance with the safety ratings shall be ensured by means of protective circuits.

Parameter		Characteristics
Installation Classifications per DIN VDE 0110/1.89 Table 1, For Rated Mains Voltage	< 150 V _{RMS}	I–IV
	< 300 V _{RMS}	I–III
Climatic Classification		55/100/21
Pollution Degree (DIN VDE 0110/1.89)		2
Comparative Tracking Index		175

Symbol	Parameter	Value	Unit
V _{PR}	Input-to-Output Test Voltage, Method A, V _{IORM} × 1.6 = V _{PR} , Type and Sample Test with t _m = 10 s, Partial Discharge < 5 pC	904	V _{peak}
	Input-to-Output Test Voltage, Method B, V _{IORM} × 1.875 = V _{PR} , 100% Production Test with t _m = 1 s, Partial Discharge < 5 pC	1060	V _{peak}
V _{IORM}	Maximum Working Insulation Voltage	565	V _{peak}
V _{IOTM}	Highest Allowable Over-Voltage	4000	V _{peak}
	External Creepage	≥ 4	mm
	External Clearance	≥ 4	mm
DTI	Distance Through Insulation (Insulation Thickness)	≥ 0.4	mm
T _S	Case Temperature ⁽¹⁾	150	°C
I _{S,INPUT}	Input Current ⁽¹⁾	200	mA
P _{S,OUTPUT}	Output Power ⁽¹⁾	300	mW
R _{IO}	Insulation Resistance at T _S , V _{IO} = 500 V ⁽¹⁾	> 10 ⁹	Ω

Note:

1. Safety limit values – maximum values allowed in the event of a failure.

Absolute Maximum Ratings

Stresses exceeding the absolute maximum ratings may damage the device. The device may not function or be operable above the recommended operating conditions and stressing the parts to these levels is not recommended. In addition, extended exposure to stresses above the recommended operating conditions may affect device reliability. The absolute maximum ratings are stress ratings only. $T_A = 25^\circ\text{C}$ unless otherwise specified.

Symbol	Rating	Value	Unit
TOTAL DEVICE			
T_{STG}	Storage Temperature	-40 to +125	$^\circ\text{C}$
T_A	Ambient Operating Temperature	-40 to +100	$^\circ\text{C}$
T_J	Junction Temperature	-40 to +125	$^\circ\text{C}$
T_{SOL}	Lead Solder Temperature	260 for 10 seconds	$^\circ\text{C}$
P_D	Total Device Power Dissipation @ $T_A = 25^\circ\text{C}$	240	mW
	Derate above 25°C	2.94	mW/ $^\circ\text{C}$
EMITTER			
I_F	Continuous Forward Current	60	mA
I_F (pk)	Forward Current – Peak (PW = 100 μs , 120 pps)	1.0	A
V_R	Reverse Voltage	6.0	V
P_D	LED Power Dissipation @ $T_A = 25^\circ\text{C}$	90	mW
	Derate above 25°C	0.8	mW/ $^\circ\text{C}$
DETECTOR			
I_C	Continuous Collector Current	150	mA
V_{CEO}	Collector-Emitter Voltage	30	V
V_{ECO}	Emitter-Collector Voltage	7	V
P_D	Detector Power Dissipation @ $T_A = 25^\circ\text{C}$	150	mW
	Derate above 25°C	1.76	mW/ $^\circ\text{C}$

Electrical Characteristics

$T_A = 25^\circ\text{C}$ unless otherwise specified.

Symbol	Parameter	Test Conditions	Min.	Typ.	Max.	Unit
EMITTER						
V_F	Input Forward Voltage MOC216M, MOC217M	$I_F = 1\text{ mA}$		1.07	1.3	V
	MOC205M, MOC206M, MOC207M MOC211M, MOC212M, MOC213M	$I_F = 10\text{ mA}$		1.15	1.5	V
I_R	Reverse Leakage Current	$V_R = 6\text{ V}$		0.001	100	μA
C_{IN}	Input Capacitance			18		pF
DETECTOR						
I_{CEO1}	Collector-Emitter Dark Current	$V_{CE} = 10\text{ V}, T_A = 25^\circ\text{C}$		1.0	50	nA
I_{CEO2}		$V_{CE} = 10\text{ V}, T_A = 100^\circ\text{C}$		1.0		μA
BV_{CEO}	Collector-Emitter Breakdown Voltage MOC205M, MOC206M, MOC207M	$I_C = 100\text{ }\mu\text{A}$	70	100		V
	MOC211M, MOC212M, MOC213M, MOC216M, MOC217M	$I_C = 100\text{ }\mu\text{A}$	30	100		V
BV_{CBO}	Collector-Base Breakdown Voltage	$I_C = 10\text{ }\mu\text{A}$	70	120		V
BV_{ECO}	Emitter-Collector Breakdown Voltage	$I_E = 100\text{ }\mu\text{A}$	7	10		V
C_{CE}	Collector-Emitter Capacitance	$f = 1.0\text{ MHz}, V_{CE} = 0$		7		pF
COUPLED						
CTR	Collector-Output Current MOC205M	$I_F = 10\text{ mA}, V_{CE} = 10\text{ V}$	40		80	%
	MOC206M	$I_F = 10\text{ mA}, V_{CE} = 10\text{ V}$	63		125	%
	MOC207M	$I_F = 10\text{ mA}, V_{CE} = 10\text{ V}$	100		200	%
	MOC211M	$I_F = 10\text{ mA}, V_{CE} = 10\text{ V}$	20			%
	MOC212M	$I_F = 10\text{ mA}, V_{CE} = 10\text{ V}$	50			%
	MOC213M	$I_F = 10\text{ mA}, V_{CE} = 10\text{ V}$	100			%
	MOC216M	$I_F = 1\text{ mA}, V_{CE} = 5\text{ V}$	50			%
	MOC217M	$I_F = 1\text{ mA}, V_{CE} = 5\text{ V}$	100			%
$V_{CE(SAT)}$	Collector-Emitter Saturation Voltage MOC205M, MOC206M, MOC207M MOC211M, MOC212M, MOC213M	$I_C = 2\text{ mA}, I_F = 10\text{ mA}$			0.4	V
	MOC216M, MOC217M	$I_C = 100\text{ }\mu\text{A}, I_F = 1\text{ mA}$			0.4	V
t_{on}	Turn-On Time	$I_C = 2\text{ mA}, V_{CC} = 10\text{ V},$ $R_L = 100\text{ }\Omega$ (Figure 12)		7.5		μs
t_{off}	Turn-Off Time	$I_C = 2\text{ mA}, V_{CC} = 10\text{ V},$ $R_L = 100\text{ }\Omega$ (Figure 12)		5.7		μs
t_r	Rise Time	$I_C = 2\text{ mA}, V_{CC} = 10\text{ V},$ $R_L = 100\text{ }\Omega$ (Figure 12)		3.2		μs
t_f	Fall Time	$I_C = 2\text{ mA}, V_{CC} = 10\text{ V},$ $R_L = 100\text{ }\Omega$ (Figure 12)		4.7		μs

Isolation Characteristics

Symbol	Characteristic	Test Conditions	Min.	Typ.	Max.	Unit
V_{ISO}	Input-Output Isolation Voltage	$t = 1 \text{ Minute}$	2500			$V_{AC_{RMS}}$
C_{ISO}	Isolation Capacitance	$V_{I-O} = 0 \text{ V}, f = 1 \text{ MHz}$		0.2		pF
R_{ISO}	Isolation Resistance	$V_{I-O} = \pm 500 \text{ VDC}, T_A = 25^\circ\text{C}$	10^{11}			Ω



Typical Performance Curves

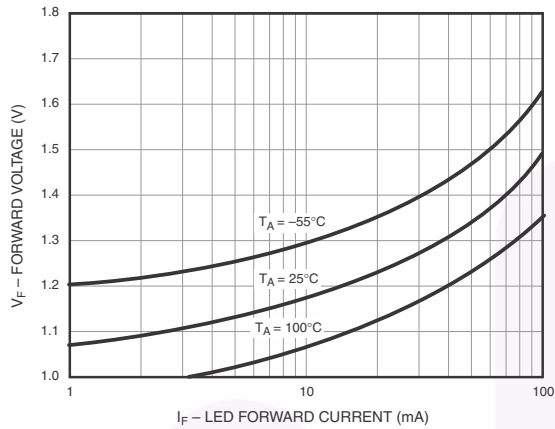

Figure 3. LED Forward Voltage vs. Forward Current

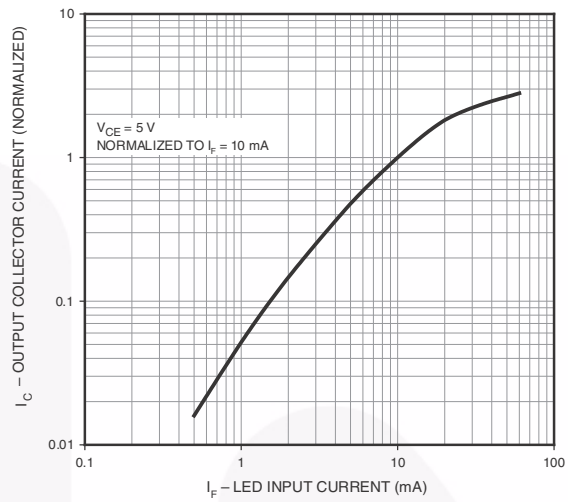

Figure 4. Output Current vs. Input Current

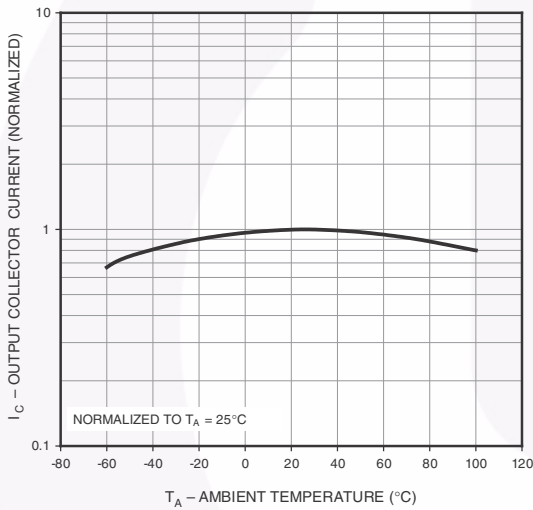

Figure 5. Output Current vs. Ambient Temperature

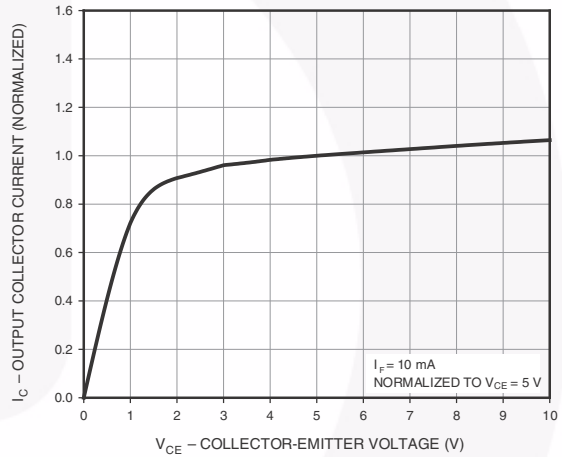

Figure 6. Output Current vs. Collector-Emitter Voltage

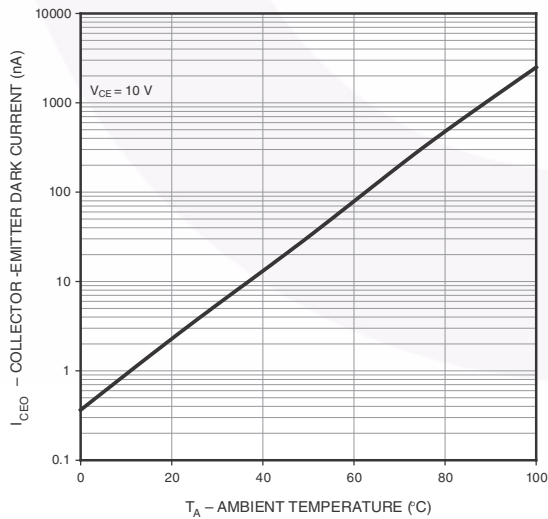

Figure 7. Dark Current vs. Ambient Temperature

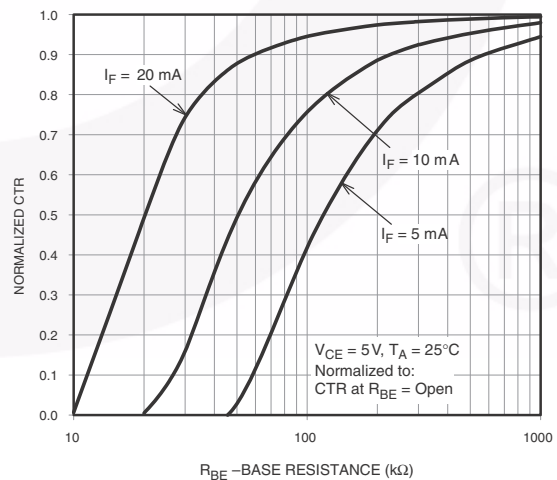

Figure 8. CTR vs. R_{BE} (Unsaturated)

Typical Performance Curves (Continued)

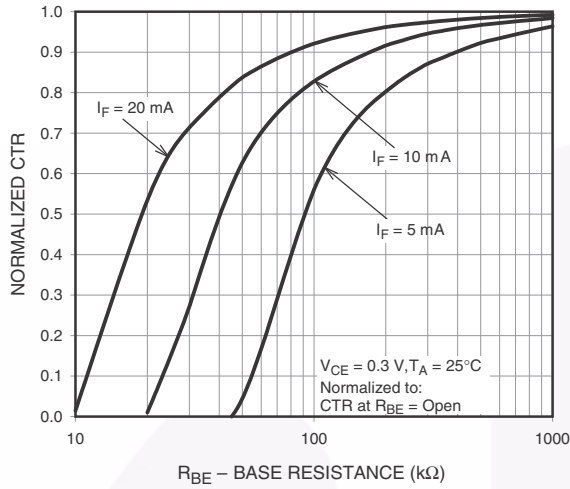

Figure 9. CTR vs. RBE (Saturated)

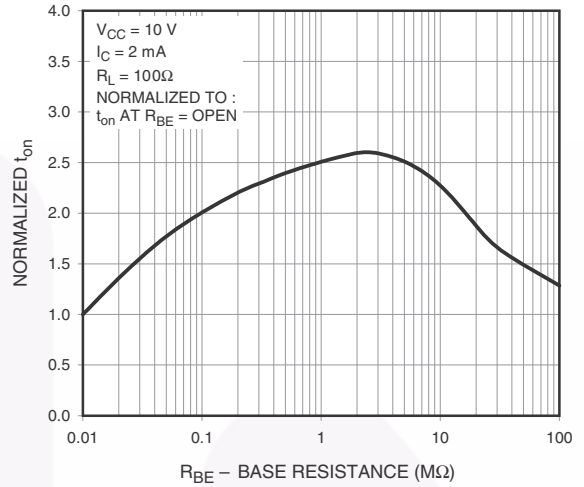

Figure 10. Normalized t_{on} vs. R_{BE}

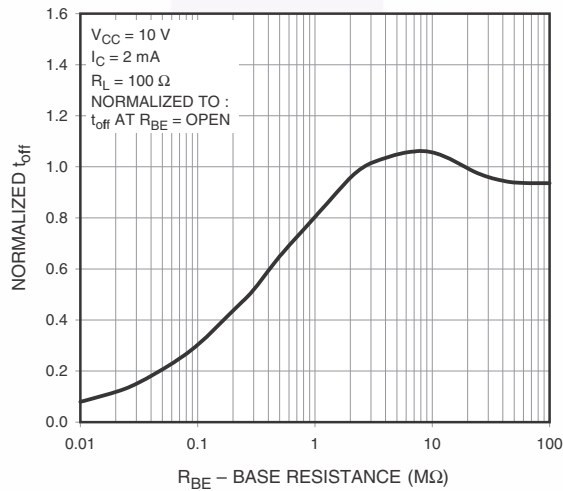

Figure 11. Normalized t_{off} vs. R_{BE}

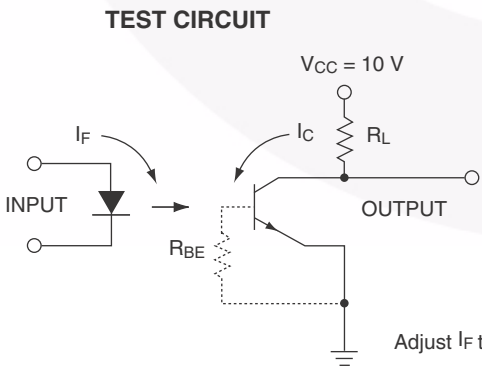

Figure 12. Switching Time Test Circuit and Waveforms

Reflow Profile

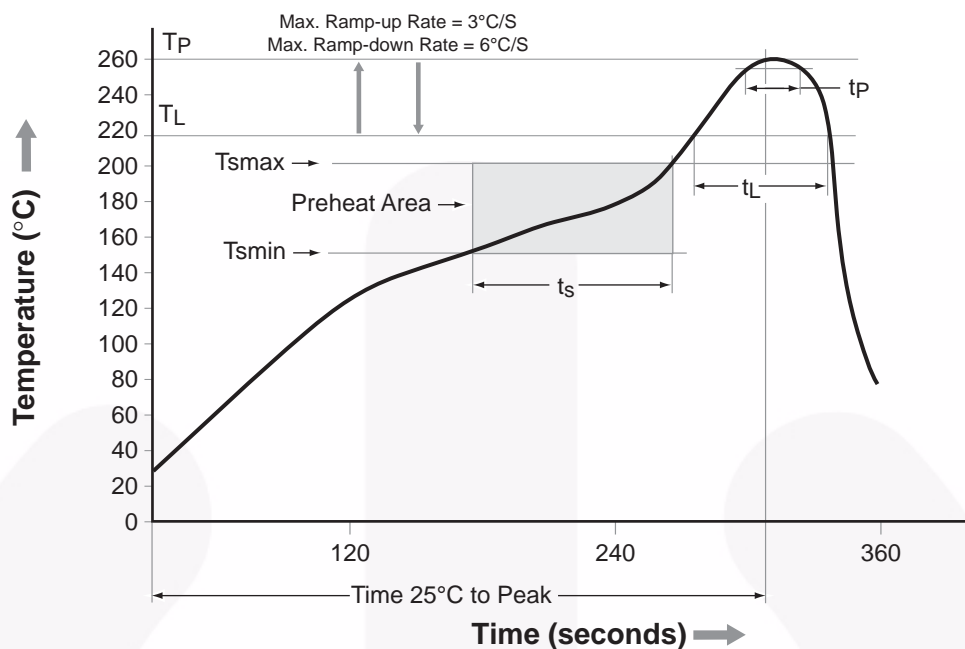

Figure 13. Reflow Profile

Profile Feature	Pb-Free Assembly Profile
Temperature Minimum (Tsmmin)	150°C
Temperature Maximum (Tsmmax)	200°C
Time (ts) from (Tsmmin to Tsmmax)	60–120 seconds
Ramp-up Rate (tL to tp)	3°C/second maximum
Liquidous Temperature (TPL)	217°C
Time (tL) Maintained Above (TPL)	60–150 seconds
Peak Body Package Temperature	260°C +0°C / -5°C
Time (tp) within 5°C of 260°C	30 seconds
Ramp-down Rate (TP to TPL)	6°C/second maximum
Time 25°C to Peak Temperature	8 minutes maximum

Ordering Information⁽²⁾

Part Number	Package	Packing Method
MOC205M	Small Outline 8-Pin	Tube (100 Units)
MOC205R2M	Small Outline 8-Pin	Tape and Reel (2500 Units)
MOC205VM	Small Outline 8-Pin, DIN EN/IEC60747-5-5 Option	Tube (100 Units)
MOC205R2VM	Small Outline 8-Pin, DIN EN/IEC60747-5-5 Option	Tape and Reel (2500 Units)

Note:

2. The product orderable part number system listed in this table also applies to the MOC20XM and MOC21XM products.

Marking Information

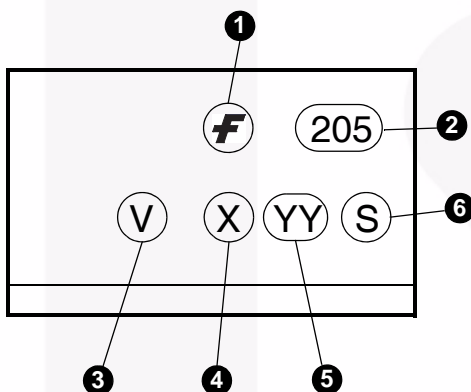

Figure 14. Top Mark

Table 1. Top Mark Definitions

1	Fairchild Logo
2	Device Number
3	DIN EN/IEC60747-5-5 Option (only appears on component ordered with this option)
4	One-Digit Year Code, e.g., "4"
5	Digit Work Week, Ranging from "01" to "53"
6	Assembly Package Code



NOTES:

- A) NO STANDARD APPLIES TO THIS PACKAGE
- B) ALL DIMENSIONS ARE IN MILLIMETERS.
- C) DIMENSIONS DO NOT INCLUDE MOLD FLASH OR BURRS.
- D) LANDPATTERN STANDARD: SOIC127P600X175-8M.
- E) DRAWING FILENAME: MKT-M08Erev5



ON Semiconductor and  are trademarks of Semiconductor Components Industries, LLC dba ON Semiconductor or its subsidiaries in the United States and/or other countries. ON Semiconductor owns the rights to a number of patents, trademarks, copyrights, trade secrets, and other intellectual property. A listing of ON Semiconductor's product/patent coverage may be accessed at www.onsemi.com/site/pdf/Patent-Marking.pdf. ON Semiconductor reserves the right to make changes without further notice to any products herein. ON Semiconductor makes no warranty, representation or guarantee regarding the suitability of its products for any particular purpose, nor does ON Semiconductor assume any liability arising out of the application or use of any product or circuit, and specifically disclaims any and all liability, including without limitation special, consequential or incidental damages. Buyer is responsible for its products and applications using ON Semiconductor products, including compliance with all laws, regulations and safety requirements or standards, regardless of any support or applications information provided by ON Semiconductor. "Typical" parameters which may be provided in ON Semiconductor data sheets and/or specifications can and do vary in different applications and actual performance may vary over time. All operating parameters, including "Typicals" must be validated for each customer application by customer's technical experts. ON Semiconductor does not convey any license under its patent rights nor the rights of others. ON Semiconductor products are not designed, intended, or authorized for use as a critical component in life support systems or any FDA Class 3 medical devices or medical devices with a same or similar classification in a foreign jurisdiction or any devices intended for implantation in the human body. Should Buyer purchase or use ON Semiconductor products for any such unintended or unauthorized application, Buyer shall indemnify and hold ON Semiconductor and its officers, employees, subsidiaries, affiliates, and distributors harmless against all claims, costs, damages, and expenses, and reasonable attorney fees arising out of, directly or indirectly, any claim of personal injury or death associated with such unintended or unauthorized use, even if such claim alleges that ON Semiconductor was negligent regarding the design or manufacture of the part. ON Semiconductor is an Equal Opportunity/Affirmative Action Employer. This literature is subject to all applicable copyright laws and is not for resale in any manner.

PUBLICATION ORDERING INFORMATION

LITERATURE FULFILLMENT:



Literature Distribution Center for ON Semiconductor
19521 E. 32nd Pkwy, Aurora, Colorado 80011 USA
Phone: 303-675-2175 or 800-344-3860 Toll Free USA/Canada
Fax: 303-675-2176 or 800-344-3867 Toll Free USA/Canada
Email: orderlit@onsemi.com

N. American Technical Support: 800-282-9855 Toll Free
USA/Canada
Europe, Middle East and Africa Technical Support:
Phone: 421 33 790 2910
Japan Customer Focus Center
Phone: 81-3-5817-1050

ON Semiconductor Website: www.onsemi.com
Order Literature: <http://www.onsemi.com/orderlit>
For additional information, please contact your local
Sales Representative

Looking for pricing, stock, or lifecycle information?

Click below to explore more details on WIN SOURCE:

-  [View MOC217R2M on WIN SOURCE](#)
-  [Fairchild/ON Semiconductor Information](#)

Optimize Your Supply Chain with WIN SOURCE Solutions

-  Global Sourcing Solution
-  Obsolete Management
-  Cost Control Management
-  Shortage Management
-  Alternative Solution
-  Excess Inventory Management