



THE DATASHEET OF MOC8100M



TIL111

TIL111-M

TIL117-M

MOC8100-M

WHITE PACKAGE (-M SUFFIX)

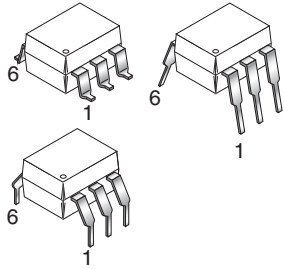

SCHEMATIC

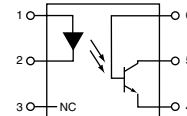

PIN 1. ANODE
2. CATHODE
3. NO CONNECTION
4. EMITTER
5. COLLECTOR
6. BASE

BLACK PACKAGE (NO -M SUFFIX)

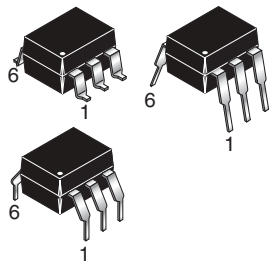

DESCRIPTION

The MOC8100, TIL111 and TIL117 optocouplers consist of a gallium arsenide infrared emitting diode driving a silicon phototransistor in a 6-pin dual in-line package.

FEATURES

- The TIL111 is also available in both black and white packages by specifying -M suffix, e.g. TIL111-M for the white package and no suffix for the black package.
- UL recognized (File # E90700)
- VDE recognized (File # 94766); (File #102497 for white package)
 - Add option V for white package (e.g., TIL111V-M)
 - Add option 300 for black package (e.g., TIL111.300)

APPLICATIONS

- Power supply regulators
- Digital logic inputs
- Microprocessor inputs
- Appliance sensor systems
- Industrial controls

TIL111

TIL111-M

TIL117-M

MOC8100-M

ABSOLUTE MAXIMUM RATINGS ($T_A = 25^\circ\text{C}$ unless otherwise specified)

Parameter	Device	Symbol	Value	Units
TOTAL DEVICE				
Storage Temperature	All	T_{STG}	-55 to +150	$^\circ\text{C}$
Operating Temperature	All	T_{OPR}	-55 to +100	$^\circ\text{C}$
Lead Solder Temperature	All	T_{SOL}	260 for 10 sec	$^\circ\text{C}$
Total Device Power Dissipation @ $T_A = 25^\circ\text{C}$ Derate above 25°C	All	P_D	250	mW
			3.3 (non-M), 2.94 (-M)	mW/ $^\circ\text{C}$
EMITTER				
DC/Average Forward Input Current	All	I_F	100 (non-M), 60 (-M)	mA
Reverse Input Voltage	TIL111/TIL111-M	V_R	3	V
	MOC8100-M/TIL117-M		6	
Forward Current - Peak (300 μs , 2% Duty Cycle)	All	$I_{F(pk)}$	3	A
LED Power Dissipation @ $T_A = 25^\circ\text{C}$ Derate above 25°C	All	P_D	150 (non-M), 120 (-M)	mW
			2.0 (non-M), 1.41 (-M)	mW/ $^\circ\text{C}$
DETECTOR				
Collector-Emitter Voltage	All	V_{CEO}	30	V
Collector-Base Voltage	All	V_{CBO}	70	V
Emitter-Collector Voltage	TIL111-M/TIL117-M	V_{ECO}	7	V
Emitter-Base Voltage	All	V_{EBO}	7	
Detector Power Dissipation @ $T_A = 25^\circ\text{C}$ Derate above 25°C	All	P_D	150	mW
			2.0 (non-M), 1.76 (-M)	mW/ $^\circ\text{C}$

TIL111

TIL111-M

TIL117-M

MOC8100-M

ELECTRICAL CHARACTERISTICS ($T_A = 25^\circ\text{C}$ unless otherwise specified)

INDIVIDUAL COMPONENT CHARACTERISTICS

Parameter	Test Conditions	Device	Symbol	Min	Typ*	Max	Unit
EMITTER							
Input Forward Voltage	$(I_F = 16 \text{ mA})$ ($T_A = 25^\circ\text{C}$)	TIL111/TIL111-M	V_F		1.2	1.4	V
	$(I_F = 10 \text{ mA; for MOC8100-M})$ ($T_A = 0\text{-}70^\circ\text{C}$)	MOC8100-M/ TIL117-M			1.2	1.4	
	$(I_F = 16 \text{ mA; for TIL117-M})$ ($T_A = -55^\circ\text{C}$)				1.32		
	$(I_F = 16 \text{ mA; for TIL117-M})$ ($T_A = +100^\circ\text{C}$)				1.10		
Reverse Leakage Current	$(V_R = 3.0 \text{ V})$	TIL111/TIL111-M/ TIL117-M	I_R		0.001	10	μA
	$(V_R = 6.0 \text{ V})$	MOC8100-M			0.001	10	μA
DETECTOR							
Collector-Emitter Breakdown Voltage	$(I_C = 1.0 \text{ mA}, I_F = 0)$	All	BV_{CEO}	30	100		V
Collector-Base Breakdown Voltage	$(I_C = 10 \mu\text{A}, I_F = 0)$	All	BV_{CBO}	70	120		V
Emitter-Base Breakdown Voltage	$(I_E = 10 \mu\text{A}, I_F = 0)$	All	BV_{EBO}	7	10		V
Emitter-Collector Breakdown Voltage	$(I_F = 100\mu\text{A}, I_F = 0)$	TIL111-M TIL117-M	BV_{ECO}	7	10		V
Collector-Emitter Dark Current	$(V_{CE} = 10 \text{ V}, I_F = 0)$	TIL111/TIL111-M/ TIL117-M	I_{CEO}		1	50	nA
	$(V_{CE} = 5 \text{ V}, T_A = 25^\circ\text{C})$	MOC8100-M	I_{CEO}		0.5	25	nA
	$(V_{CE} = 30 \text{ V}, I_F = 0, T_A = 70^\circ\text{C})$	TIL117-M/ MOC8100-M	I_{CEO}		0.2	50	μA
Collector-Base Dark Current	$(V_{CB} = 10 \text{ V})$	TIL111/TIL111-M/ TIL117-M	I_{CBO}			20	nA
	$(V_{CB} = 5 \text{ V})$	MOC8100-M	I_{CBO}			10	nA
Capacitance	$(V_{CE} = 0 \text{ V}, f = 1 \text{ MHz})$	All	C_{CE}		8		pF

ISOLATION CHARACTERISTICS

Characteristic	Test Conditions	Symbol	Min	Typ*	Max	Units
Input-Output Isolation Voltage	(Non '-M', Black Package) ($f = 60 \text{ Hz}, t = 1 \text{ min}$)	V_{ISO}	5300			Vac(rms)
	('M', White Package) ($f = 60 \text{ Hz}, t = 1 \text{ sec}$)		7500			Vac(pk)
Isolation Resistance	$(V_{I-O} = 500 \text{ VDC})$	R_{ISO}	10^{11}			Ω
Isolation Capacitance	$(V_{I-O} = 0, f = 1 \text{ MHz})$	C_{ISO}			2	pF

Note

* Typical values at $T_A = 25^\circ\text{C}$ unless otherwise noted

TIL111

TIL111-M

TIL117-M

MOC8100-M

TRANSFER CHARACTERISTICS ($T_A = 25^\circ\text{C}$ Unless otherwise specified.)							
DC Characteristic	Test Conditions	Symbol	Device	Min	Typ*	Max	Unit
Current Transfer Ratio, Collector to Emitter	($I_F = 10\text{ mA}$, $V_{CE} = 10\text{ V}$)	CTR_{CE}	TIL117-M	50			%
	($I_F = 1\text{ mA}$, $V_{CE} = 5\text{ V}$)		MOC8100-M	50			%
	($I_F = 1\text{ mA}$, $V_{CE} = 5\text{ V}$, $T_A = 0\text{ to }+70^\circ\text{C}$)			30			
On-State Collector Current (Phototransistor Operation)	($I_F = 16\text{ mA}$, $V_{CE} = 0.4\text{ V}$)	$I_{C(ON)}$	TIL111	2			mA
On-State Collector Current (Photodiode Operation)	($I_F = 16\text{ mA}$, $V_{CB} = 0.4\text{ V}$)		TIL111-M	7			μA
Collector-Emitter Saturation Voltage	($I_C = 500\text{ }\mu\text{A}$, $I_F = 10\text{ mA}$)	$V_{CE(SAT)}$	TIL117-M			0.4	V
	($I_C = 2\text{ mA}$, $I_F = 16\text{ mA}$)		TIL111			0.4	
	($I_C = 100\text{ }\mu\text{A}$, $I_F = 1\text{ mA}$)		MOC8100-M			0.5	
AC Characteristic	($I_C = 2\text{ mA}$, $V_{CC} = 10\text{ V}$, $R_L = 100\Omega$) (Fig. 20)	T_{ON}	MOC8100-M			20	μs
Turn-On Time			TIL117-M			10	
Turn-Off Time		T_{OFF}	MOC8100-M			20	μs
			TIL117-M			10	
Rise Time		t_r	MOC8100-M		2		μs
Fall Time		t_f	TIL117-M		2		
Rise Time (Phototransistor Operation)		($I_{C(ON)} = 2\text{ mA}$, $V_{CC} = 10\text{ V}$, $R_L = 100\Omega$) (Fig. 20)	t_r	TIL111			10
Fall Time (Phototransistor Operation)	t_f		TIL111-M				

* Typical values at $T_A = 25^\circ\text{C}$

TIL111

TIL111-M

TIL117-M

MOC8100-M

TYPICAL PERFORMANCE CURVES

Fig. 1 LED Forward Voltage vs. Forward Current (Black Package)

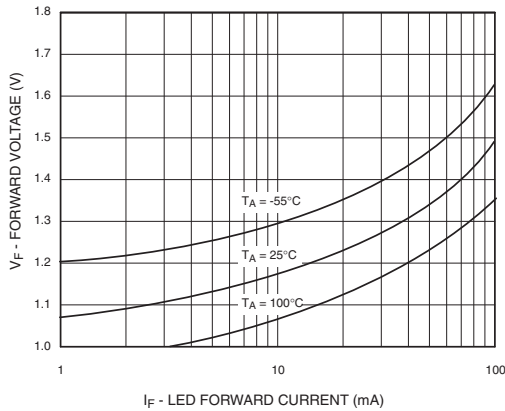

Fig. 2 LED Forward Voltage vs. Forward Current (White Package)

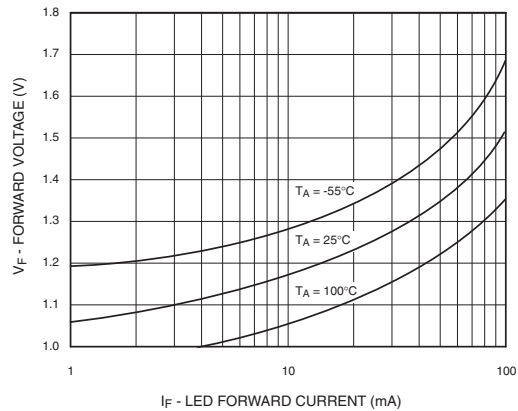

Fig.3 Normalized CTR vs. Forward Current (Black Package)

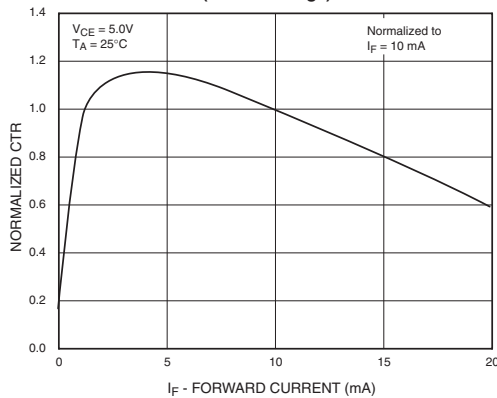

Fig.4 Normalized CTR vs. Forward Current (White Package)

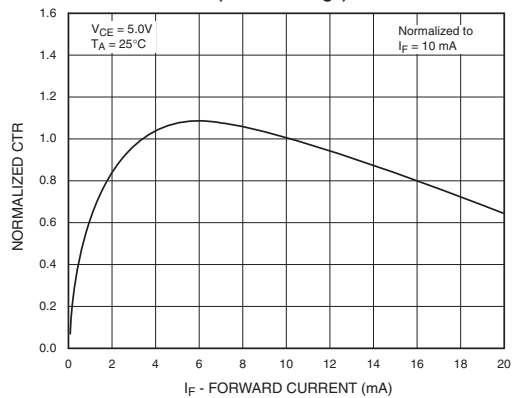

Fig. 5 Normalized CTR vs. Ambient Temperature (Black Package)

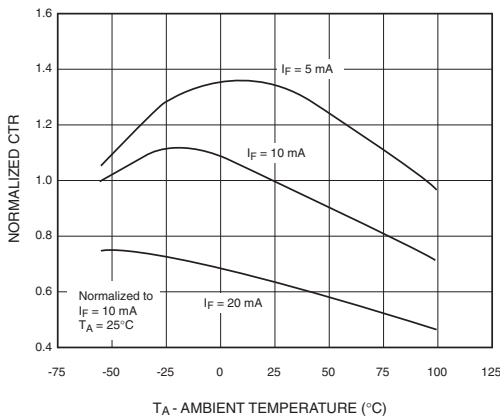
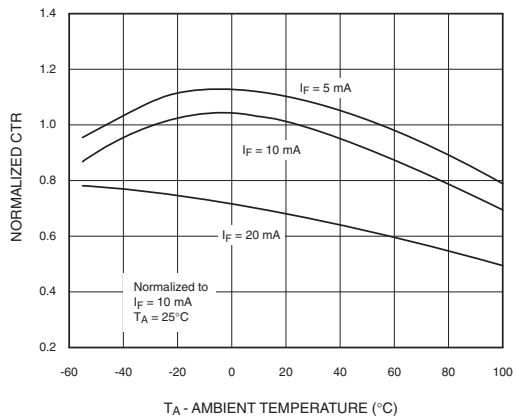

Fig. 6 Normalized CTR vs. Ambient Temperature (White Package)



TIL111

TIL111-M

TIL117-M

MOC8100-M

**Fig. 7 CTR vs. RBE (Unsaturated)
(Black Package)**

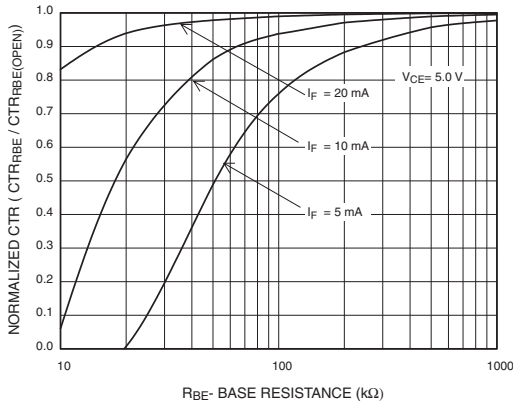

**Fig. 8 CTR vs. RBE (Unsaturated)
(White Package)**

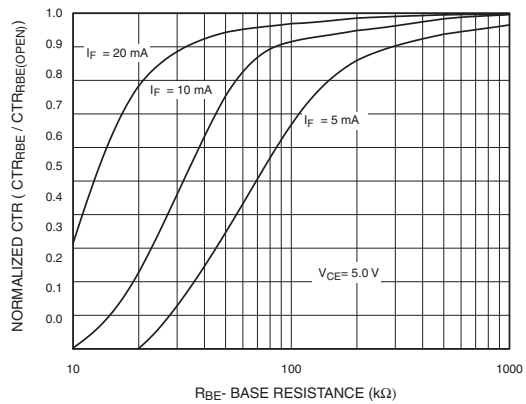

**Fig. 9 CTR vs. RBE (Saturated)
(Black Package)**

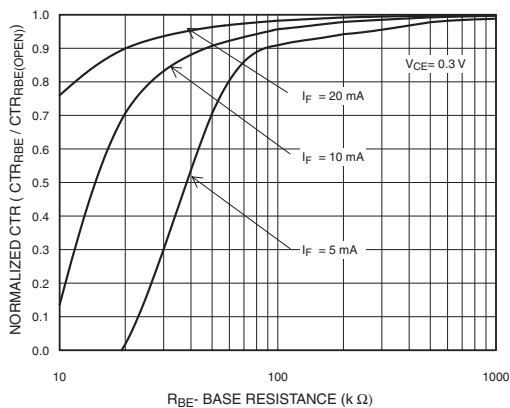

**Fig. 10 CTR vs. RBE (Saturated)
(White Package)**

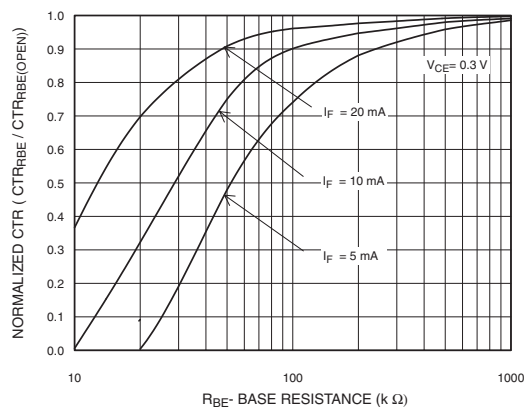

**Fig. 11 Collector-Emitter Saturation Voltage vs. Collector Current
(Black Package)**

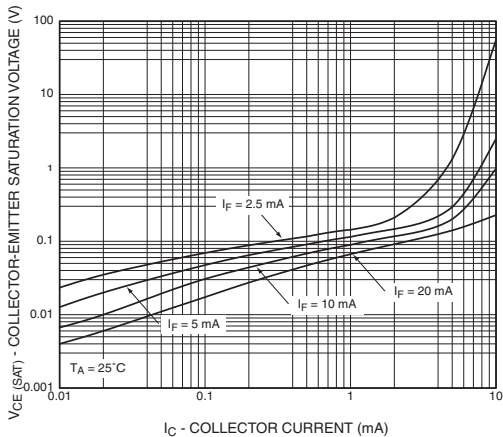

**Fig. 12 Collector-Emitter Saturation Voltage vs. Collector Current
(White Package)**

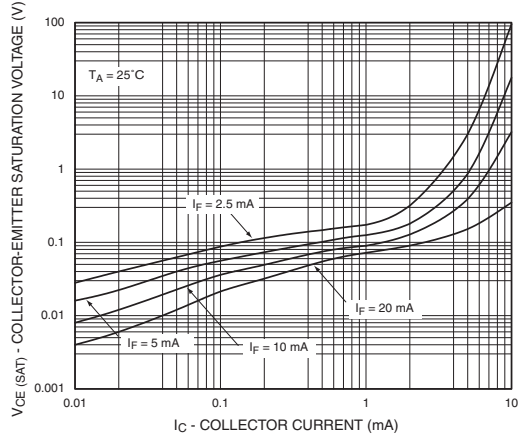

TIL111

TIL111-M

TIL117-M

MOC8100-M

**Fig. 13 Switching Speed vs. Load Resistor
(Black Package)**

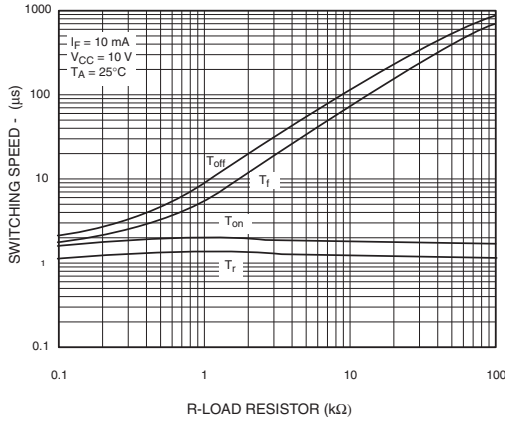

**Fig. 14 Switching Speed vs. Load Resistor
(White Package)**

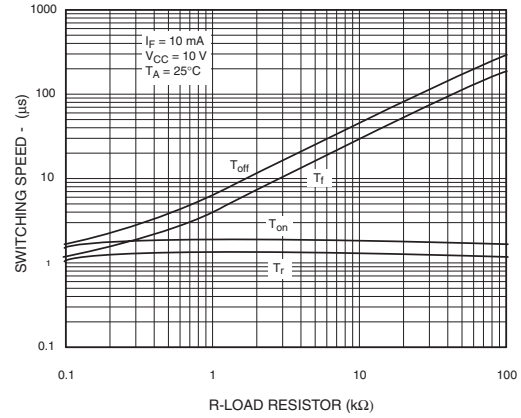

**Fig. 15 Normalized t_{on} vs. R_{BE}
(Black Package)**

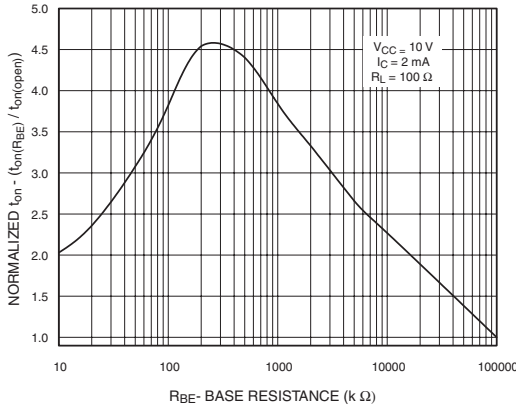

**Fig. 16 Normalized t_{on} vs. R_{BE}
(White Package)**

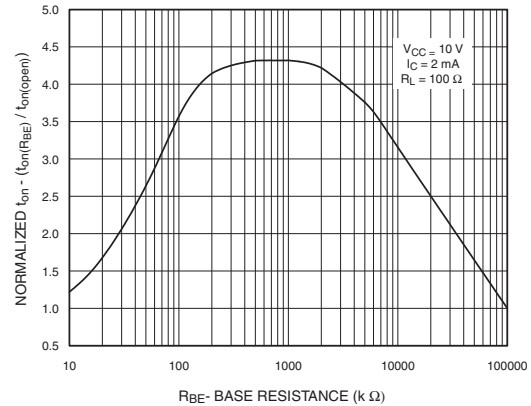

**Fig. 17 Normalized t_{off} vs. R_{BE}
(Black Package)**

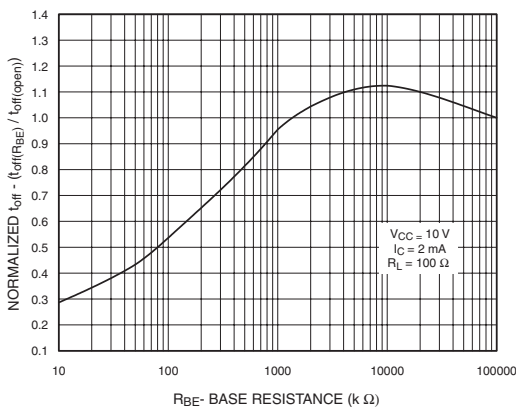

**Fig. 18 Normalized t_{off} vs. R_{BE}
(White Package)**

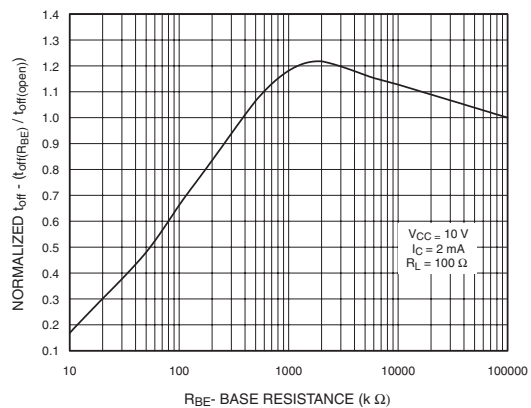

Fig. 19 Dark Current vs. Ambient Temperature

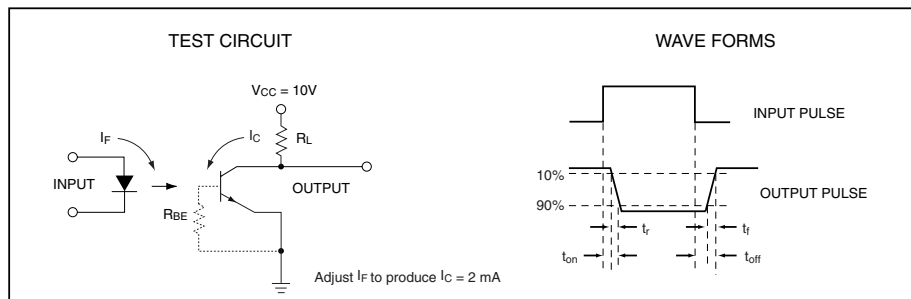
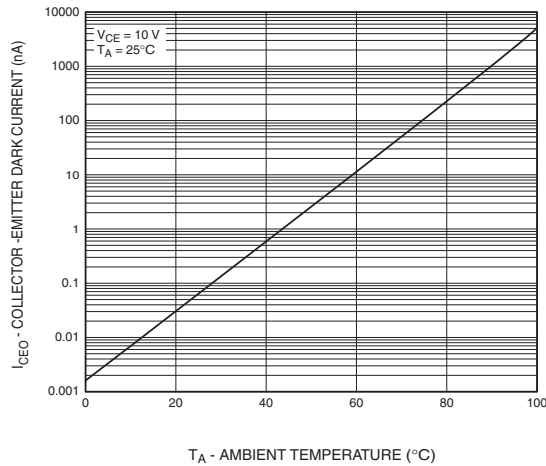

Figure 20. Switching Time Test Circuit and Waveforms

TIL111

TIL111-M

TIL117-M

MOC8100-M

White Package (-M Suffix)

Package Dimensions (Through Hole)

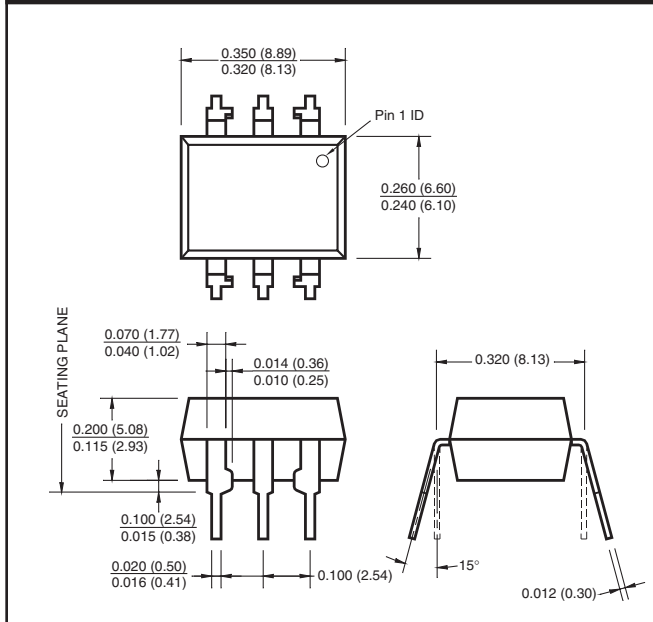

Package Dimensions (Surface Mount)

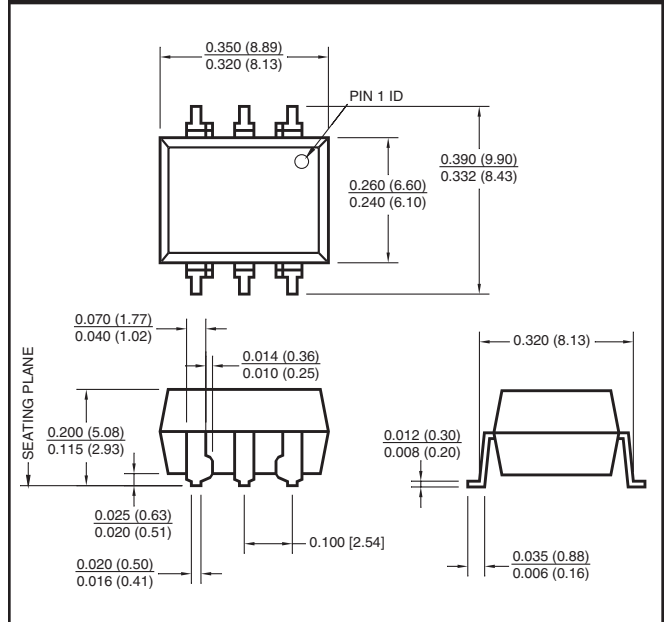

Package Dimensions (0.4" Lead Spacing)

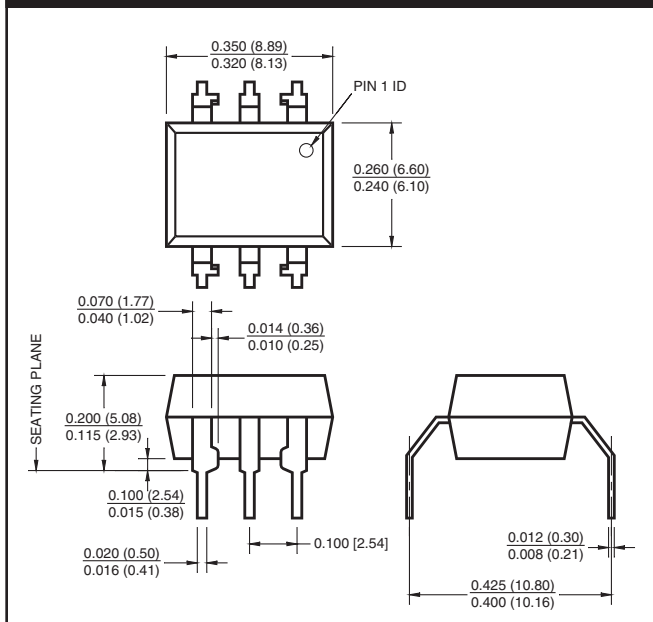

**Recommended Pad Layout for
Surface Mount Leadform**

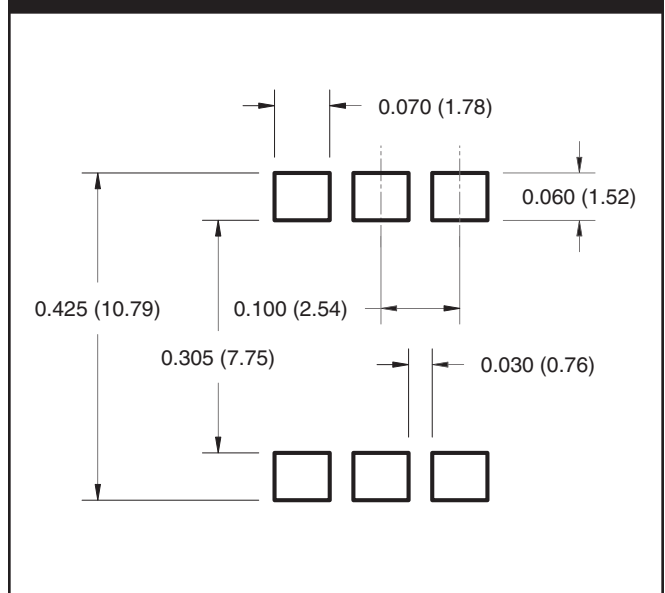

NOTE

All dimensions are in inches (millimeters)

TIL111

TIL111-M

TIL117-M

MOC8100-M

ORDERING INFORMATION

Order Entry Identifier		
Black Package (No Suffix)	White Package (-M Suffix)	Option
.S	S	Surface Mount Lead Bend
.SD	SR2	Surface Mount; Tape and reel
.W	T	0.4" Lead Spacing
.300	V	VDE 0884
.300W	TV	VDE 0884, 0.4" Lead Spacing
.3S	SV	VDE 0884, Surface Mount
.3SD	SR2V	VDE 0884, Surface Mount, Tape & Reel

MARKING INFORMATION

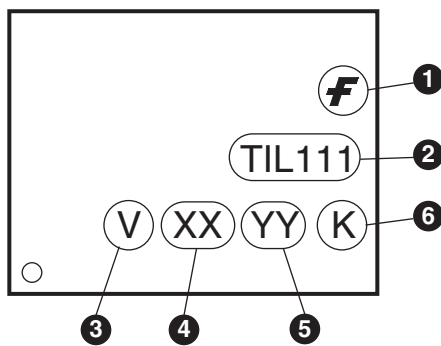

Black Package, No Suffix

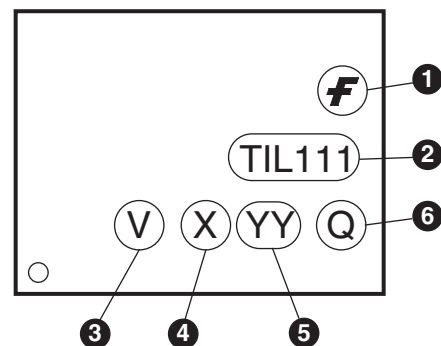

White Package, -M Suffix

Definitions	
1	Fairchild logo
2	Device number
3	VDE mark (Note: Only appears on parts ordered with VDE option – See order entry table)
4	One or two digit year code • Two digits for black package parts, e.g., '03' • One digit for white package parts, e.g., '3'
5	Two digit work week ranging from '01' to '53'
6	Assembly package code

*Note – Parts built in the white package (M suffix) that do not have the 'V' option (see definition 3 above) that are marked with date code '325' or earlier are marked in the portrait format.

TIL111

TIL111-M

TIL117-M

MOC8100-M

Carrier Tape Specifications (Black Package, No Suffix)

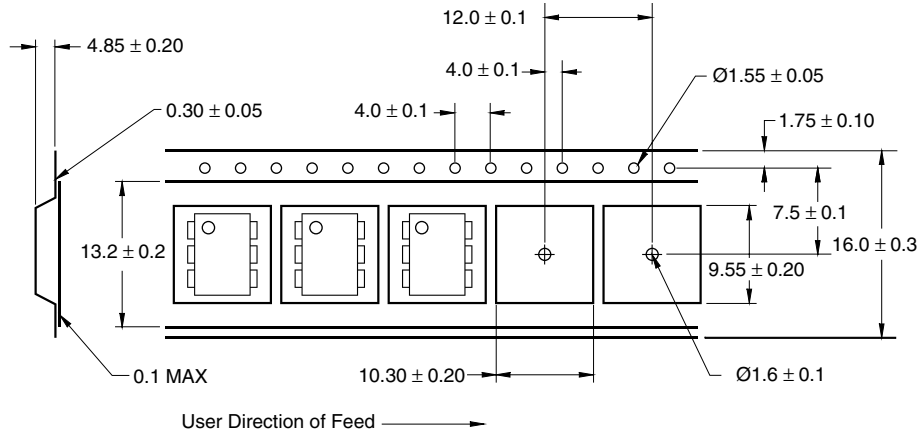

Carrier Tape Specifications (White Package, -M Suffix)

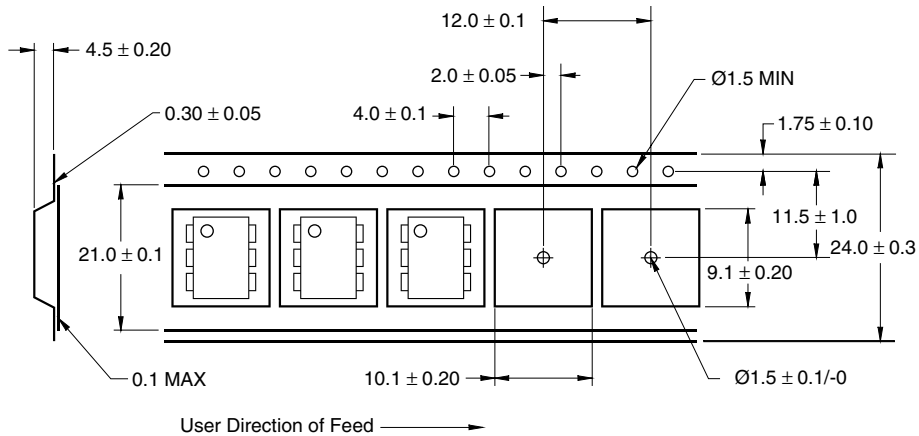

TIL111

TIL111-M

TIL117-M

MOC8100-M

Reflow Profile (White Package, -M Suffix)

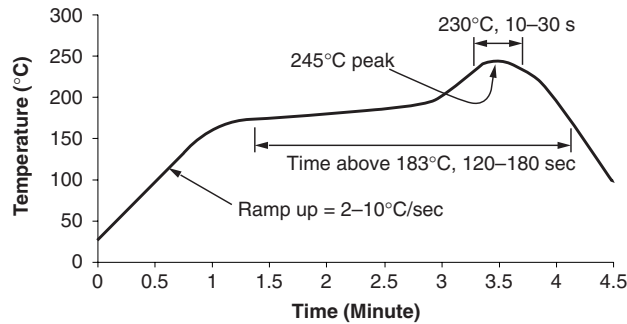

- Peak reflow temperature: 245°C (package surface temperature)
- Time of temperature higher than 183°C for 120-180 seconds
- One time soldering reflow is recommended

Reflow Profile (Black Package, No Suffix)

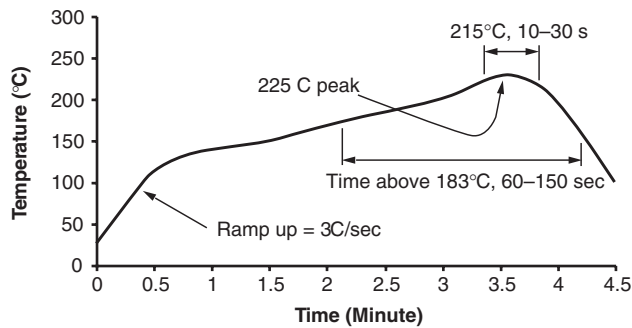

- Peak reflow temperature: 225°C (package surface temperature)
- Time of temperature higher than 183°C for 60-150 seconds
- One time soldering reflow is recommended

TIL111

TIL111-M

TIL117-M

MOC8100-M

DISCLAIMER

FAIRCHILD SEMICONDUCTOR RESERVES THE RIGHT TO MAKE CHANGES WITHOUT FURTHER NOTICE TO ANY PRODUCTS HEREIN TO IMPROVE RELIABILITY, FUNCTION OR DESIGN. FAIRCHILD DOES NOT ASSUME ANY LIABILITY ARISING OUT OF THE APPLICATION OR USE OF ANY PRODUCT OR CIRCUIT DESCRIBED HEREIN; NEITHER DOES IT CONVEY ANY LICENSE UNDER ITS PATENT RIGHTS, NOR THE RIGHTS OF OTHERS.



LIFE SUPPORT POLICY

FAIRCHILD'S PRODUCTS ARE NOT AUTHORIZED FOR USE AS CRITICAL COMPONENTS IN LIFE SUPPORT DEVICES OR SYSTEMS WITHOUT THE EXPRESS WRITTEN APPROVAL OF THE PRESIDENT OF FAIRCHILD SEMICONDUCTOR CORPORATION. As used herein:

1. Life support devices or systems are devices or systems which, (a) are intended for surgical implant into the body, or (b) support or sustain life, and (c) whose failure to perform when properly used in accordance with instructions for use provided in the labeling, can be reasonably expected to result in a significant injury of the user.
2. A critical component in any component of a life support device or system whose failure to perform can be reasonably expected to cause the failure of the life support device or system, or to affect its safety or effectiveness.

Looking for pricing, stock, or lifecycle information?

Click below to explore more details on WIN SOURCE:

-  [View MOC8100M on WIN SOURCE](#)
-  [Fairchild/ON Semiconductor Information](#)

Optimize Your Supply Chain with WIN SOURCE Solutions

-  Global Sourcing Solution
-  Obsolete Management
-  Cost Control Management
-  Shortage Management
-  Alternative Solution
-  Excess Inventory Management