



Is Now Part of



ON Semiconductor®

To learn more about ON Semiconductor, please visit our website at
www.onsemi.com

Please note: As part of the Fairchild Semiconductor integration, some of the Fairchild orderable part numbers will need to change in order to meet ON Semiconductor's system requirements. Since the ON Semiconductor product management systems do not have the ability to manage part nomenclature that utilizes an underscore (_), the underscore (_) in the Fairchild part numbers will be changed to a dash (-). This document may contain device numbers with an underscore (_). Please check the ON Semiconductor website to verify the updated device numbers. The most current and up-to-date ordering information can be found at www.onsemi.com. Please email any questions regarding the system integration to Fairchild_questions@onsemi.com.

ON Semiconductor and the ON Semiconductor logo are trademarks of Semiconductor Components Industries, LLC dba ON Semiconductor or its subsidiaries in the United States and/or other countries. ON Semiconductor owns the rights to a number of patents, trademarks, copyrights, trade secrets, and other intellectual property. A listing of ON Semiconductor's product/patent coverage may be accessed at www.onsemi.com/site/pdf/Patent-Marking.pdf. ON Semiconductor reserves the right to make changes without further notice to any products herein. ON Semiconductor makes no warranty, representation or guarantee regarding the suitability of its products for any particular purpose, nor does ON Semiconductor assume any liability arising out of the application or use of any product or circuit, and specifically disclaims any and all liability, including without limitation special, consequential or incidental damages. Buyer is responsible for its products and applications using ON Semiconductor products, including compliance with all laws, regulations and safety requirements or standards, regardless of any support or applications information provided by ON Semiconductor. "Typical" parameters which may be provided in ON Semiconductor data sheets and/or specifications can and do vary in different applications and actual performance may vary over time. All operating parameters, including "Typicals" must be validated for each customer application by customer's technical experts. ON Semiconductor does not convey any license under its patent rights nor the rights of others. ON Semiconductor products are not designed, intended, or authorized for use as a critical component in life support systems or any FDA Class 3 medical devices or medical devices with a same or similar classification in a foreign jurisdiction or any devices intended for implantation in the human body. Should Buyer purchase or use ON Semiconductor products for any such unintended or unauthorized application, Buyer shall indemnify and hold ON Semiconductor and its officers, employees, subsidiaries, affiliates, and distributors harmless against all claims, costs, damages, and expenses, and reasonable attorney fees arising out of, directly or indirectly, any claim of personal injury or death associated with such unintended or unauthorized use, even if such claim alleges that ON Semiconductor was negligent regarding the design or manufacture of the part. ON Semiconductor is an Equal Opportunity/Affirmative Action Employer. This literature is subject to all applicable copyright laws and is not for resale in any manner.



October 2014

CNY171M, CNY172M, CNY173M, CNY174M, CNY17F1M, CNY17F2M, CNY17F3M, CNY17F4M, MOC8106M 6-Pin DIP High BV_{CEO} Phototransistor Optocouplers

Features

- High BV_{CEO} : 70 V Minimum (CNY17XM, CNY17FXM, MOC8106M)
- Closely Matched Current Transfer Ratio (CTR) Minimizes Unit-to-Unit Variation
- Current Transfer Ratio In Select Groups
- Very Low Coupled Capacitance Along With No Chip-to-Pin 6 Base Connection for Minimum Noise Susceptability (CNY17FXM, MOC8106M)
- Safety and Regulatory Approvals:
 - UL1577, 4,170 VAC_{RMS} for 1 Minute
 - DIN-EN/IEC60747-5-5, 850 V Peak Working Insulation Voltage

Applications

- Power Supply Regulators
- Digital Logic Inputs
- Microprocessor Inputs
- Appliance Sensor Systems
- Industrial Controls

Description

The CNY17XM, CNY17FXM, and MOC8106M devices consist of a gallium arsenide infrared emitting diode coupled with an NPN phototransistor in a dual in-line package.

Package Outlines



Figure 1. Package Outlines

Schematics

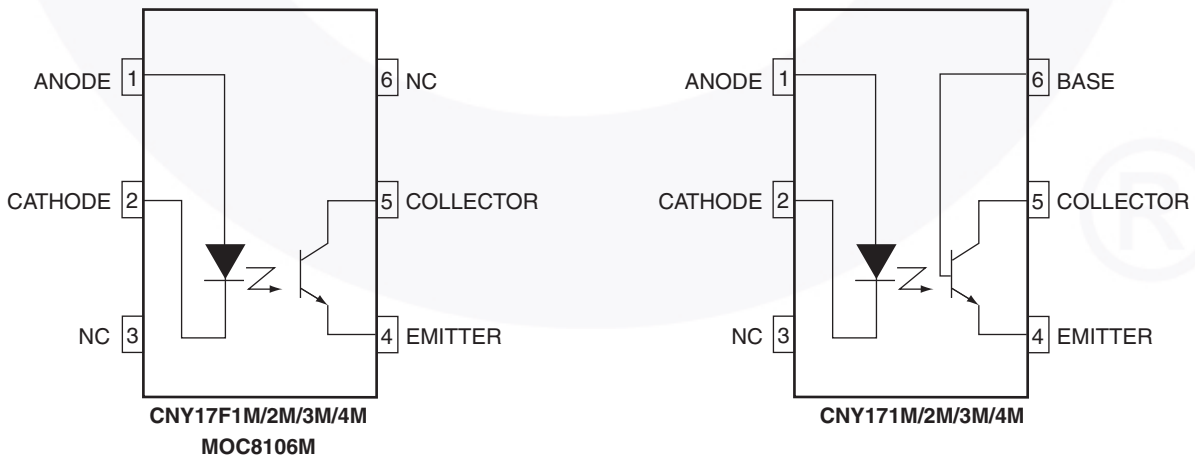

Figure 2. Schematics

CNY17XM, CNY17FXM, MOC8106M — 6-Pin DIP High BV_{CEO} Phototransistor Optocouplers

Safety and Insulation Ratings

As per DIN EN/IEC 60747-5-5, this optocoupler is suitable for “safe electrical insulation” only within the safety limit data. Compliance with the safety ratings shall be ensured by means of protective circuits.

Parameter		Characteristics
Installation Classifications per DIN VDE 0110/1.89 Table 1, For Rated Mains Voltage	< 150 V _{RMS}	I–IV
	< 300 V _{RMS}	I–IV
Climatic Classification		55/100/21
Pollution Degree (DIN VDE 0110/1.89)		2
Comparative Tracking Index		175

Symbol	Parameter	Value	Unit
V _{PR}	Input-to-Output Test Voltage, Method A, V _{IORM} × 1.6 = V _{PR} , Type and Sample Test with t _m = 10 s, Partial Discharge < 5 pC	1360	V _{peak}
	Input-to-Output Test Voltage, Method B, V _{IORM} × 1.875 = V _{PR} , 100% Production Test with t _m = 1 s, Partial Discharge < 5 pC	1594	V _{peak}
V _{IORM}	Maximum Working Insulation Voltage	850	V _{peak}
V _{IOTM}	Highest Allowable Over-Voltage	6000	V _{peak}
	External Creepage	≥ 7	mm
	External Clearance	≥ 7	mm
	External Clearance (for Option TV, 0.4" Lead Spacing)	≥ 10	mm
DTI	Distance Through Insulation (Insulation Thickness)	≥ 0.5	mm
T _S	Case Temperature ⁽¹⁾	175	°C
I _{S,INPUT}	Input Current ⁽¹⁾	350	mA
P _{S,OUTPUT}	Output Power ⁽¹⁾	800	mW
R _{IO}	Insulation Resistance at T _S , V _{IO} = 500 V ⁽¹⁾	> 10 ⁹	Ω

Note:

1. Safety limit values – maximum values allowed in the event of a failure.

Absolute Maximum Ratings

Stresses exceeding the absolute maximum ratings may damage the device. The device may not function or be operable above the recommended operating conditions and stressing the parts to these levels is not recommended. In addition, extended exposure to stresses above the recommended operating conditions may affect device reliability. The absolute maximum ratings are stress ratings only.

Symbol	Parameters	Value	Units
TOTAL DEVICE			
T _{STG}	Storage Temperature	-40 to +125	°C
T _A	Ambient Operating Temperature	-40 to +100	°C
T _J	Junction Temperature	-40 to +125	°C
T _{SOL}	Lead Solder Temperature	260 for 10 seconds	°C
P _D	Total Device Power Dissipation @ 25°C (LED plus detector) Derate Linearly From 25°C	270	mW
		2.94	mW/°C
EMITTER			
I _F	Continuous Forward Current	60	mA
V _R	Reverse Voltage	6	V
I _F (pk)	Forward Current – Peak (1 μs pulse, 300 pps)	1.5	A
P _D	LED Power Dissipation 25°C Ambient Derate Linearly From 25°C	120	mW
		1.41	mW/°C
DETECTOR			
I _C	Continuous Collector Current	50	mA
V _{CEO}	Collector-Emitter Voltage	70	V
V _{ECO}	Emitter Collector Voltage	7	V
P _D	Detector Power Dissipation @ 25°C Derate Linearly from 25°C	150	mW
		1.76	mW/°C

Electrical Characteristics

$T_A = 25^\circ\text{C}$ unless otherwise specified.

Individual Component Characteristics

Symbol	Parameters	Test Conditions	Device	Min.	Typ.	Max.	Units
EMITTER							
V_F	Input Forward Voltage	$I_F = 10\text{ mA}$	All Devices	1.0	1.15	1.50	V
		$I_F = 60\text{ mA}$	CNY17XM, CNY17FXM	1.0	1.35	1.65	v
C_J	Capacitance	$V_F = 0\text{ V}, f = 1.0\text{ MHz}$	All Devices		18		pF
I_R	Reverse Leakage Current	$V_R = 6\text{ V}$	All Devices		0.001	10	μA
DETECTOR							
BV_{CEO}	Breakdown Voltage Collector-to-Emitter	$I_C = 1\text{ mA}, I_F = 0$	All Devices	70	100		V
BV_{CBO}	Collector-to-Base	$I_C = 10\text{ }\mu\text{A}, I_F = 0$	CNY17XM	70	120		V
BV_{ECO}	Emitter-to-Collector	$I_E = 100\text{ }\mu\text{A}, I_F = 0$	All Devices	7	10		V
I_{CEO}	Leakage Current Collector-to-Emitter	$V_{CE} = 10\text{ V}, I_F = 0$	All Devices		1	50	nA
I_{CBO}	Collector-to-Base	$V_{CB} = 10\text{ V}, I_F = 0$	CNY17XM			20	nA
C_{CE}	Capacitance Collector-to-Emitter	$V_{CE} = 0, f = 1\text{ MHz}$	All Devices		8		pF
C_{CB}	Collector-to-Base	$V_{CB} = 0, f = 1\text{ MHz}$	CNY17XM		20		pF
C_{EB}	Emitter-to-Base	$V_{EB} = 0, f = 1\text{ MHz}$	CNY17XM		10		pF

Transfer Characteristics

Symbol	Parameters	Test Conditions	Device	Min.	Typ.	Max.	Units
COUPLED							
CTR	Current Transfer Ratio	$I_F = 10\text{ mA}, V_{CE} = 10\text{ V}$	MOC8106M	50		150	%
		$I_F = 10\text{ mA}, V_{CE} = 5\text{ V}$	CNY171M, CNY17F1M	40		80	%
		$I_F = 10\text{ mA}, V_{CE} = 5\text{ V}$	CNY172M, CNY17F2M	63		125	%
		$I_F = 10\text{ mA}, V_{CE} = 5\text{ V}$	CNY173M, CNY17F3M	100		200	%
		$I_F = 10\text{ mA}, V_{CE} = 5\text{ V}$	CNY174M, CNY17F4M	160		320	%
$V_{CE(SAT)}$	Collector-Emitter Saturation Voltage	$I_C = 0.5\text{ mA}, I_F = 5\text{ mA}$	MOC8106M			0.4	V
		$I_C = 2.5\text{ mA}, I_F = 10\text{ mA}$	CNY17XM/CNY17FXM				

Electrical Characteristics (Continued)T_A = 25°C unless otherwise specified.**AC Characteristics**

Symbol	Parameters	Test Conditions	Device	Min.	Typ.	Max.	Units
NON-SATURATED SWITCHING TIME							
t _{on}	Turn-On Time	I _C = 2.0 mA, V _{CC} = 10 V, R _L = 100 Ω	All Devices		2.0	10.0	μs
t _{off}	Turn-Off Time	I _C = 2.0 mA, V _{CC} = 10 V, R _L = 100 Ω	All Devices		3.0	10.0	μs
t _d	Delay Time	I _F = 10 mA, V _{CC} = 5 V, R _L = 75 Ω	CNY17XM/CNY17FXM			5.6	μs
t _r	Rise Time	I _F = 10 mA, V _{CC} = 5 V, R _L = 75 Ω	CNY17XM/CNY17FXM			4.0	μs
t _s	Storage Time	I _F = 10 mA, V _{CC} = 5 V, R _L = 75 Ω	CNY17XM/CNY17FXM			4.1	μs
t _f	Fall Time	I _F = 10 mA, V _{CC} = 5 V, R _L = 75 Ω	CNY17XM/CNY17FXM			3.5	μs
SATURATED SWITCHING TIMES							
t _d	Delay Time	I _F = 20 mA, V _{CC} = 5 V, R _L = 1 kΩ	CNY171M/F1M			5.5	μs
		I _F = 10 mA, V _{CC} = 5 V, R _L = 1 kΩ	CNY172M/3M/4M CNY17F2M/F3M/F4M			8.0	μs
t _r	Rise Time	I _F = 20 mA, V _{CC} = 5 V, R _L = 1 kΩ	CNY171M/F1M			4.0	μs
		I _F = 10 mA, V _{CC} = 5 V, R _L = 1 kΩ	CNY172M/3M/4M CNY17F2M/F3M/F4M			6.0	μs
t _s	Storage Time	I _F = 20 mA, V _{CC} = 5 V, R _L = 1 kΩ	CNY171M/F1M			34.0	μs
		I _F = 10 mA, V _{CC} = 5 V, R _L = 1 kΩ	CNY172M/3M/4M CNY17F2M/F3M/F4M			39.0	μs
t _f	Fall Time	I _F = 20 mA, V _{CC} = 5 V, R _L = 1 kΩ	CNY171M/F1M			20.0	μs
		I _F = 10 mA, V _{CC} = 5 V, R _L = 1 kΩ	CNY172M/3M/4M CNY17F2M/F3M/F4M			24.0	μs

Isolation Characteristics

Symbol	Characteristic	Test Conditions	Min.	Typ.	Max.	Units
V _{ISO}	Input-Output Isolation Voltage	t = 1 Minute	4170			V _{ACRMS}
C _{ISO}	Isolation Capacitance	V _{I-O} = 0 V, f = 1 MHz		0.2		pF
R _{ISO}	Isolation Resistance	V _{I-O} = ±500 VDC, T _A = 25°C	10 ¹¹			Ω

Typical Performance Characteristics



Figure 3. Normalized CTR vs. Forward Current



Figure 4. Normalized CTR vs. Ambient Temperature



Figure 5. CTR vs. R_{BE} (Unsaturated)

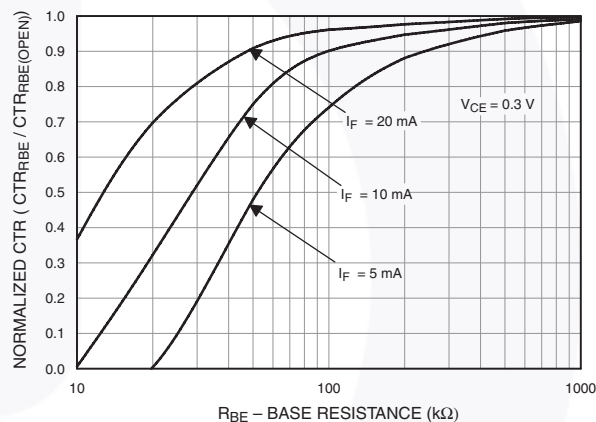

Figure 6. CTR vs. R_{BE} (Saturated)



Figure 7. Switching Speed vs. Load Resistor



Figure 8. Normalized t_{on} vs. R_{BE}

Typical Performance Characteristics (Continued)

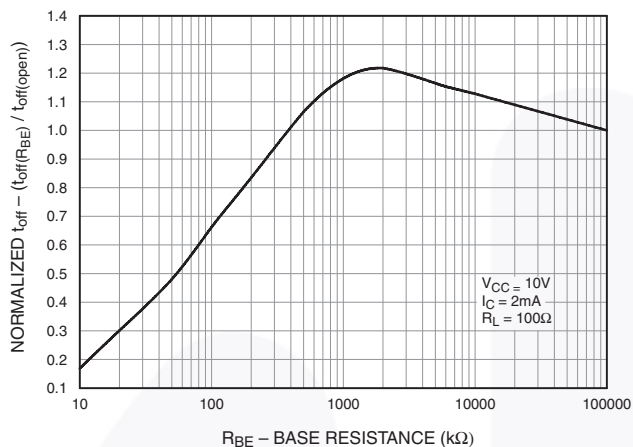

Figure 9. Normalized t_{off} vs. R_{BE}



Figure 10. LED Forward Voltage vs. Forward Current



Figure 11. Collector-Emitter Saturation Voltage vs. Collector Current

Switching Test Circuit and Waveforms

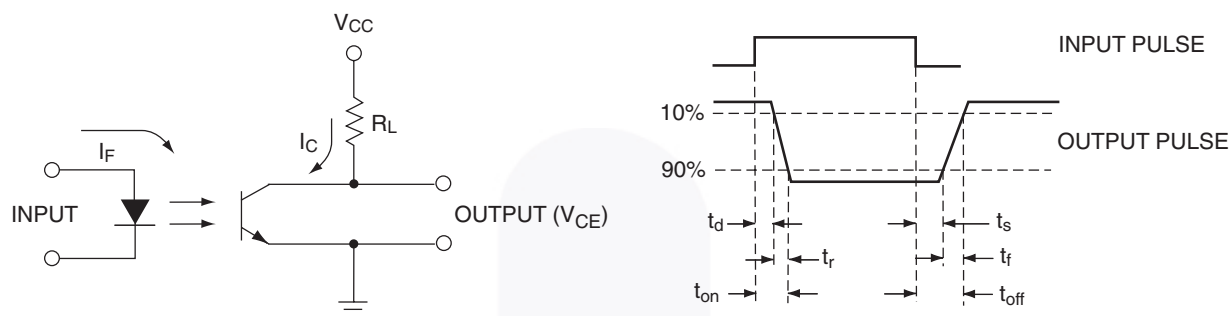

Figure 12. Switching Test Circuit and Waveforms

Reflow Profile

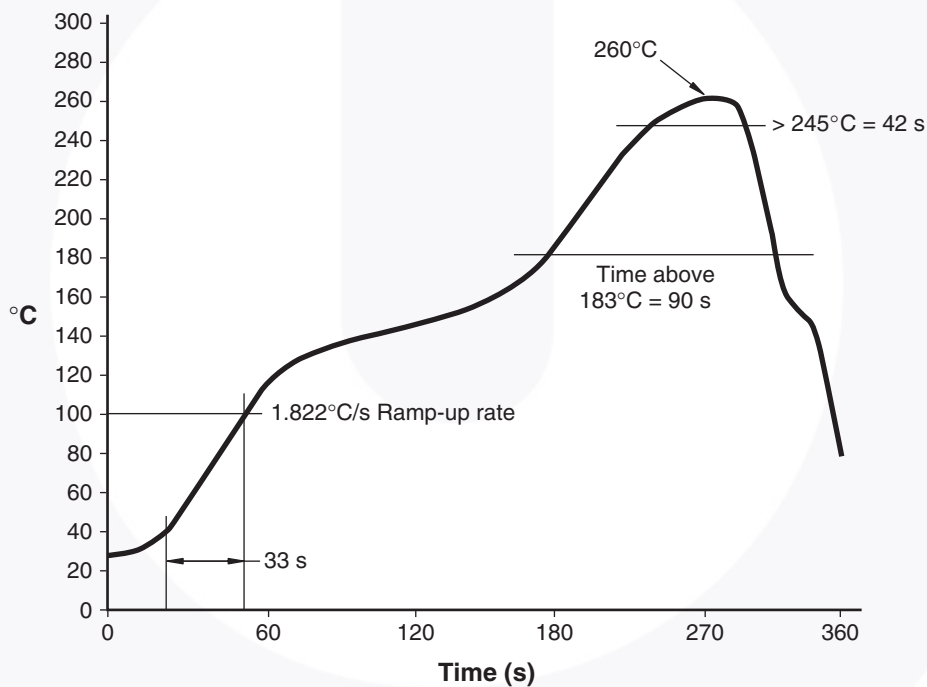

Figure 13. Reflow Profile

Ordering Information

Part Number	Package	Packing Method
CNY171M	DIP 6-Pin	Tube (50 Units)
CNY171SM	SMT 6-Pin (Lead Bend)	Tube (50 Units)
CNY171SR2M	SMT 6-Pin (Lead Bend)	Tape and Reel (1000 Units)
CNY171TM	DIP 6-Pin, 0.4" Lead Spacing	Tube (50 Units)
CNY171VM	DIP 6-Pin, DIN EN/IEC60747-5-5 Option	Tube (50 Units)
CNY171SVM	SMT 6-Pin (Lead Bend), DIN EN/IEC60747-5-5 Option	Tube (50 Units)
CNY171SR2VM	SMT 6-Pin (Lead Bend), DIN EN/IEC60747-5-5 Option	Tape and Reel (1000 Units)
CNY171TVM	DIP 6-Pin, 0.4" Lead Spacing, DIN EN/IEC60747-5-5 Option	Tube (50 Units)

Note:

2. The product orderable part number system listed in this table also applies to the CNY17FXM product family and the MOC8106M device.

Marking Information

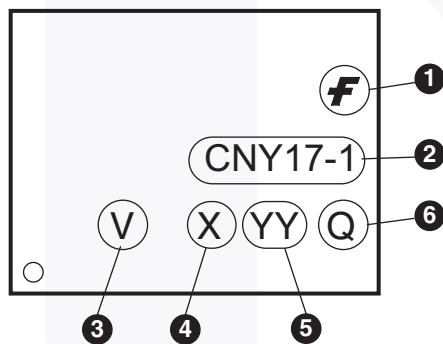

Figure 14. Top Mark

Table 1. Top Mark Definitions

1	Fairchild Logo
2	Device Number
3	DIN EN/IEC60747-5-5 Option (only appears on component ordered with this option)
4	One-Digit Year Code, e.g., "4"
5	Digit Work Week, Ranging from "01" to "53"
6	Assembly Package Code



NOTES:

- A) NO STANDARD APPLIES TO THIS PACKAGE.
- B) ALL DIMENSIONS ARE IN MILLIMETERS.
- C) DIMENSIONS ARE EXCLUSIVE OF BURRS, MOLD FLASH, AND TIE BAR EXTRUSION
- D) DRAWING FILENAME AND REVISION: MKT-N06BREV4.





LAND PATTERN RECOMMENDATION



NOTES:

- A) NO STANDARD APPLIES TO THIS PACKAGE.
- B) ALL DIMENSIONS ARE IN MILLIMETERS.
- C) DIMENSIONS ARE EXCLUSIVE OF BURRS, MOLD FLASH, AND TIE BAR EXTRUSION
- D) DRAWING FILENAME AND REVISION : MKT-N06CREV4.





NOTES:

- A) NO STANDARD APPLIES TO THIS PACKAGE.
- B) ALL DIMENSIONS ARE IN MILLIMETERS.
- C) DIMENSIONS ARE EXCLUSIVE OF BURRS, MOLD FLASH, AND TIE BAR EXTRUSION
- D) DRAWING FILENAME AND REVISION: MKT-N06Drev4



ON Semiconductor and  are trademarks of Semiconductor Components Industries, LLC dba ON Semiconductor or its subsidiaries in the United States and/or other countries. ON Semiconductor owns the rights to a number of patents, trademarks, copyrights, trade secrets, and other intellectual property. A listing of ON Semiconductor's product/patent coverage may be accessed at www.onsemi.com/site/pdf/Patent-Marking.pdf. ON Semiconductor reserves the right to make changes without further notice to any products herein. ON Semiconductor makes no warranty, representation or guarantee regarding the suitability of its products for any particular purpose, nor does ON Semiconductor assume any liability arising out of the application or use of any product or circuit, and specifically disclaims any and all liability, including without limitation special, consequential or incidental damages. Buyer is responsible for its products and applications using ON Semiconductor products, including compliance with all laws, regulations and safety requirements or standards, regardless of any support or applications information provided by ON Semiconductor. "Typical" parameters which may be provided in ON Semiconductor data sheets and/or specifications can and do vary in different applications and actual performance may vary over time. All operating parameters, including "Typicals" must be validated for each customer application by customer's technical experts. ON Semiconductor does not convey any license under its patent rights nor the rights of others. ON Semiconductor products are not designed, intended, or authorized for use as a critical component in life support systems or any FDA Class 3 medical devices or medical devices with a same or similar classification in a foreign jurisdiction or any devices intended for implantation in the human body. Should Buyer purchase or use ON Semiconductor products for any such unintended or unauthorized application, Buyer shall indemnify and hold ON Semiconductor and its officers, employees, subsidiaries, affiliates, and distributors harmless against all claims, costs, damages, and expenses, and reasonable attorney fees arising out of, directly or indirectly, any claim of personal injury or death associated with such unintended or unauthorized use, even if such claim alleges that ON Semiconductor was negligent regarding the design or manufacture of the part. ON Semiconductor is an Equal Opportunity/Affirmative Action Employer. This literature is subject to all applicable copyright laws and is not for resale in any manner.

PUBLICATION ORDERING INFORMATION

LITERATURE FULFILLMENT:



Literature Distribution Center for ON Semiconductor
19521 E. 32nd Pkwy, Aurora, Colorado 80011 USA
Phone: 303-675-2175 or 800-344-3860 Toll Free USA/Canada
Fax: 303-675-2176 or 800-344-3867 Toll Free USA/Canada
Email: orderlit@onsemi.com

N. American Technical Support: 800-282-9855 Toll Free
USA/Canada
Europe, Middle East and Africa Technical Support:
Phone: 421 33 790 2910
Japan Customer Focus Center
Phone: 81-3-5817-1050

ON Semiconductor Website: www.onsemi.com
Order Literature: <http://www.onsemi.com/orderlit>
For additional information, please contact your local
Sales Representative

Looking for pricing, stock, or lifecycle information?

Click below to explore more details on WIN SOURCE:

-  [View MOC8106SM on WIN SOURCE](#)
-  [Fairchild/ON Semiconductor Information](#)

Optimize Your Supply Chain with WIN SOURCE Solutions

-  Global Sourcing Solution
-  Obsolete Management
-  Cost Control Management
-  Shortage Management
-  Alternative Solution
-  Excess Inventory Management