



**THE DATASHEET OF  
MP2104DJ-LF-Z**



## DESCRIPTION

The MP2670 is a high-performance single cell Li-Ion/Li-Polymer battery charger protection circuit. By integrating high voltage input protection into the charger IC, the MP2670 can tolerate an input surge up to +30V.

The device features input over voltage protection (OVP), battery over voltage protection (BOVP) and over charge current protection (OCP). The device also provides fault indications to the system when any of the protection events happens.

For guaranteed safe operation, the MP2670 monitors its own internal temperature and turns off the MOSFET bridging VIN and OUT when the die temperature exceeds 150°C.

The MP2670 is available in a 10-pin 3mm x 3mm QFN package.

## FEATURES

- Input Surge up to 30V
- Input Over voltage protection in 1us.
- Proprietary Battery Over-Voltage Protection
- Programmable Charge Current Protection Limit Value.
- Temperature Monitoring and Protection
- Fault Indication
- Enable Input
- 3mm x 3mm QFN Package

## APPLICATIONS

- Cell Phones
- MP3 Players
- Smart Phones
- PDA
- Digital Cameras
- Desktop Chargers

"MPS" and "The Future of Analog IC Technology" are Registered Trademarks of Monolithic Power Systems, Inc.

## TYPICAL APPLICATION

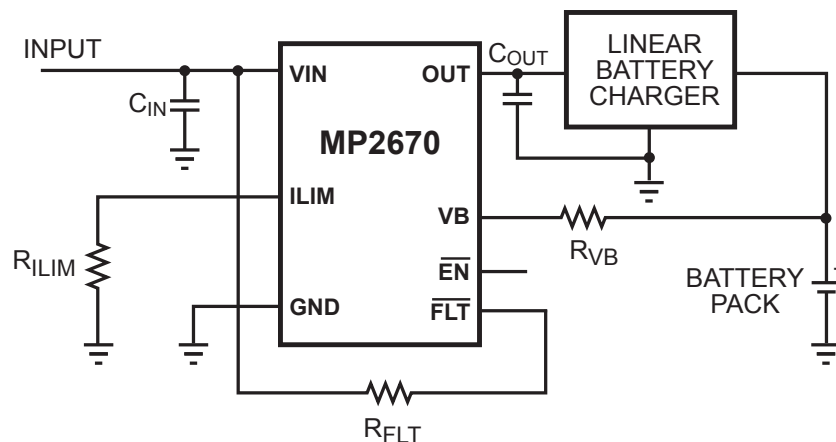

### ORDERING INFORMATION

Part Number*	Package	Top Marking	Temperature
MP2670DQ	QFN10 (3mm x 3mm)	X7	-40°C to +85°C

\* For Tape & Reel, add suffix -Z (g. MP2670DQ-Z). For RoHS compliant packaging, add suffix -LF (e.g. MP2670DQ-LF-Z)

### PACKAGE REFERENCE

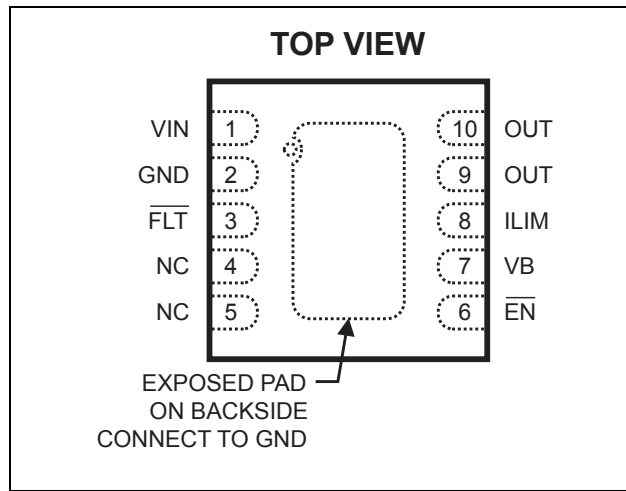

#### ABSOLUTE MAXIMUM RATINGS <sup>(1)</sup>

$V_{\text{IN}}$ to GND.....	-0.3V to 30V
OUT and VB to GND.....	-0.3V to 7V
Other Pins (ILIM, $\overline{\text{FLT}}$ , $\overline{\text{EN}}$ ).....	-0.3V to 5.5V
Junction Temperature.....	150°C
Lead Temperature (Solder).....	260°C
Storage Temperature.....	-65°C to +150°C

#### Recommended Operating Conditions <sup>(2)</sup>

Supply Voltage $V_{\text{IN}}$ .....	4.3V to 5.5V
Operating Temperature.....	-40°C to +85°C

<b>Thermal Resistance <sup>(3)</sup></b>	$\theta_{\text{JA}}$	$\theta_{\text{JC}}$
QFN10 (3mm x 3mm).....	50	12... °C/W

**Notes:**

- 1) Exceeding these ratings may damage the device.
- 2) The device is not guaranteed to function outside of its operating conditions.
- 3) Measured on JESD51-7, 4-layer PCB.

## ELECTRICAL CHARACTERISTICS

$V_{IN} = 5V$ ,  $T_A = +25^{\circ}C$ , unless otherwise noted.

Parameter	Symbol	Condition	Min	Typ	Max	Units
<b>Power-On Reset</b>						
Rising VIN Threshold	$V_{POR}$		2.45		3.0	V
POR Hysteresis				110		mV
VIN Bias Current	$I_{VIN}$	When enabled		0.6		mA
		When disabled		25		$\mu A$
<b>Protection</b>						
Input Over-voltage Protection (OVP)	$V_{OVP}$		5.55	5.80	6.0	V
Input OVP Hysteresis				50		mV
Input OVP Falling Threshold			5.45			V
Input OVP Propagation Delay					1	$\mu s$
Over-current Protection	$I_{OCP}$	$V_{VB} = 3V$ , $R_{ILIM} = 25k\Omega$	0.90	1.0	1.10	A
Overcurrent Protection Blanking Time	$BT_{OCP}$			170		$\mu s$
Battery Over-voltage Protection Threshold	$V_{BOVP}$		4.29		4.475	V
Battery OVP Threshold Hysteresis				75		mV
Battery OVP Falling Threshold			4.225			V
Battery OVP Blanking Time	$BT_{BOVP}$			180		$\mu s$
VB Pin Leakage Current		$V_{VB} = 4.4V$		20		nA
Over Temperature Protection Rising Threshold				150		$^{\circ}C$
Over Temperature Protection Falling Threshold				110		$^{\circ}C$
<b>Logic</b>						
$\overline{EN}$ Input Logic HIGH			1.5			V
$\overline{EN}$ Input Logic LOW					0.4	V
EN Internal Series Resistor			100	200	400	k $\Omega$
FLT Output Logic Low		Sink 5mA current		0.5	0.8	V
FLT Output Logic High Leakage Current					1	$\mu A$
<b>Power MOSFET</b>						
On Resistance	$R_{DS(ON)}$	Measured at 500mA, $4.3 < V_{IN} < 5.5V$		250	450	m $\Omega$

## PIN FUNCTIONS

10-pin QFN	Name	Description
1	VIN	Input Power Source. VIN can withstand 30V input.
2	GND, Exposed Pad	System Ground. Exposed pad and GND pin must be connected to the same ground plane.
3	$\overline{\text{FLT}}$	Open-Drain Logic Output. This pin turns LOW when any protection event occurs.
4	NC	No Connect. Keep it floating.
5	NC	No Connect. Keep it floating.
6	$\overline{\text{EN}}$	Enable. Leave this pin floating or pull it below 0.4V to enable the IC. Drive this pin higher than 1.5V to disable the IC.
7	VB	Battery Voltage Monitoring Input. Connect this pin to the battery pack positive terminal via an isolation resistor.
8	ILIM	Over-current Protection Threshold Setting. Connect a resistor between this pin and GND to set the OCP threshold.
9	OUT	Output pin
10	OUT	Output pin

### TYPICAL PERFORMANCE CHARACTERISTICS

$V_{CC} = 5V$ ,  $R_{LIM}=50k\Omega$ ,  $R_{FLT}=200k\Omega$ ,  $C_{IN}=4.7\mu F$ ,  $C_{OUT}=1\mu F$ ,  $T_A = +25^\circ C$ , unless otherwise noted.

**Power Up through  $V_{IN}$**

(500mA Load)

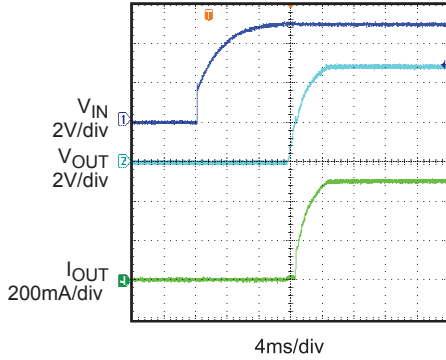

**Power Down through  $V_{IN}$**

(500mA Load)

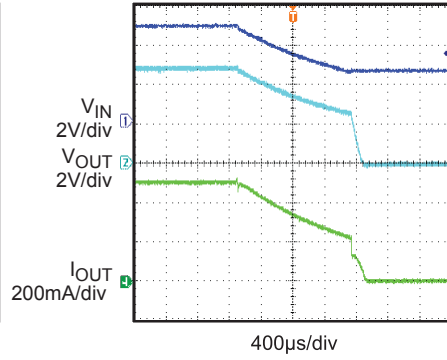

**Hot Insertion  $V_{IN}$**

(500mA Load)

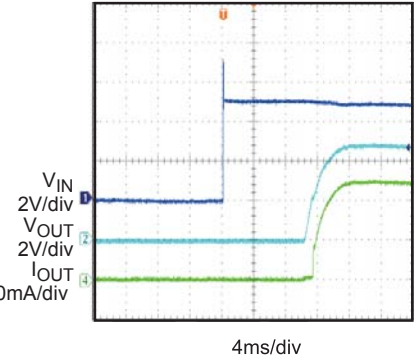

**Zoom In of Hot Insertion  $V_{IN}$**

(500mA Load)

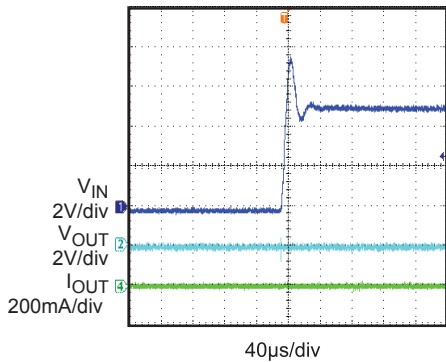

**Start Up through EN**

(500mA Load)

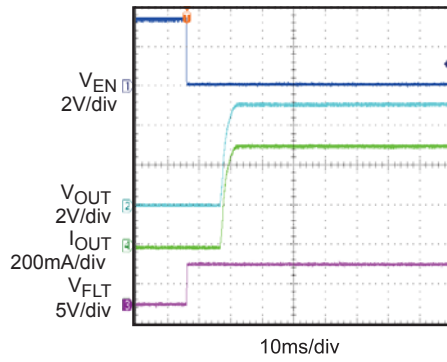

**Shut Down through EN**

(500mA Load)

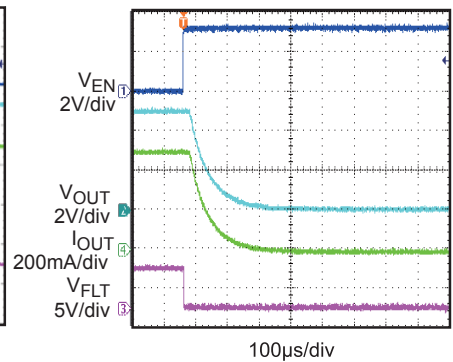

**Input OVP**

( Ramp Up  $V_{IN}$  Slowly with 500mA Load)

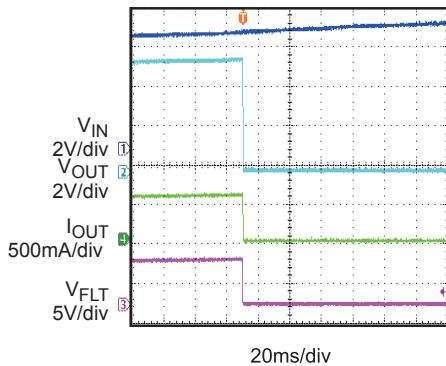

**Input OVP Removal**

( Ramp Down  $V_{IN}$  Slowly with 500mA Load)

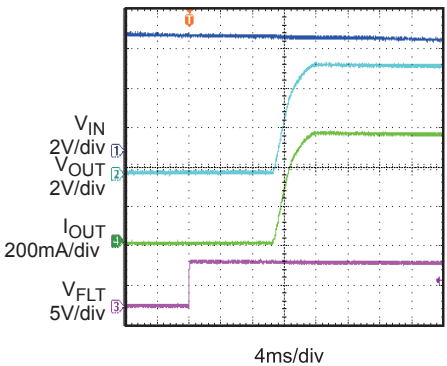

**Input OVP**

( Ramp Up  $V_{IN}$  Quickly with 500mA Load)

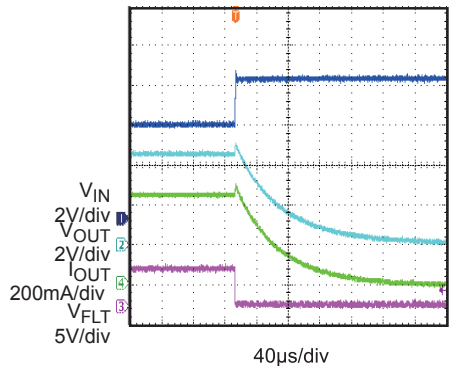

**TYPICAL PERFORMANCE CHARACTERISTICS** *(continued)*

$V_{CC} = 5V$ ,  $R_{LIM}=50k\Omega$ ,  $R_{FLT} =200k\Omega$ ,  $C_{IN}=4.7\mu F$ ,  $C_{OUT}=1\mu F$ ,  $T_A = +25^\circ C$ , unless otherwise noted.

**Start Up with OVP  $V_{IN}$**   
(500mA Load)

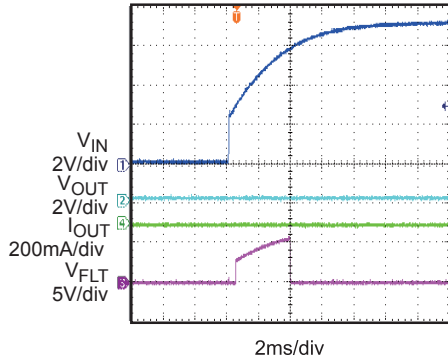

**Battery OVP within Blanking Time**  
(No Load)

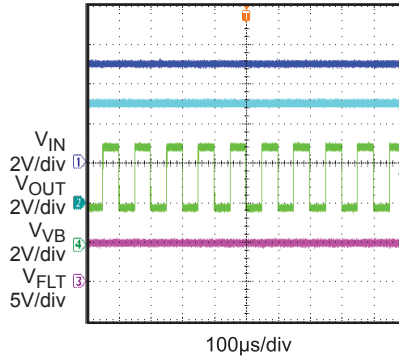

**Battery OVP**  
(Shut Down Permanently after 16 Times without Load)

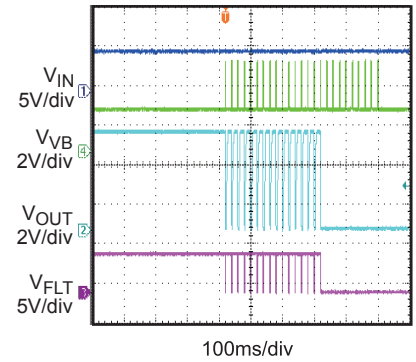

**OCP after Start Up**  
(Shut Down Permanently after 16 Times)

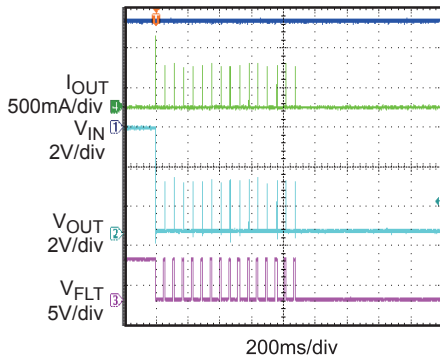

**Zoom In of OCP after Start Up**  
(50ms Interval)

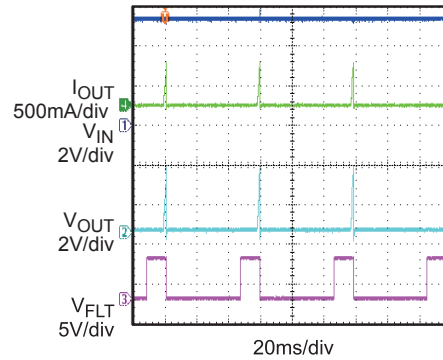

**OCP before Start Up**  
(Shut Down Permanently after 16 Times)

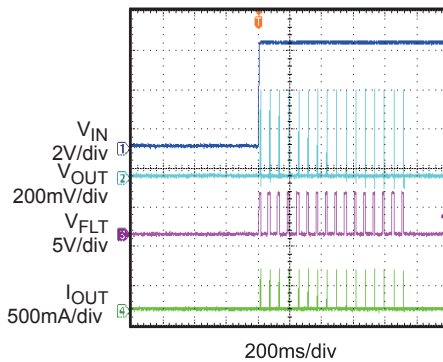

**Zoom In of OCP before Start Up**  
(50ms Interval)

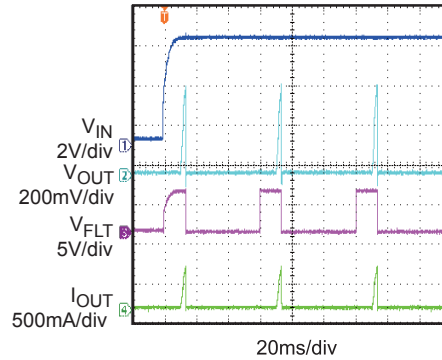

**TYPICAL PERFORMANCE CHARACTERISTICS** *(continued)*

$V_{CC} = 5V$ ,  $R_{ILIM} = 50k\Omega$ ,  $R_{FLT} = 200k\Omega$ ,  $C_{IN} = 4.7\mu F$ ,  $C_{OUT} = 1\mu F$ ,  $T_A = +25^\circ C$ , unless otherwise noted.

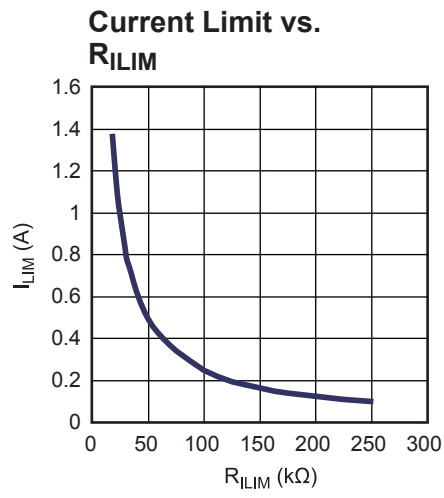
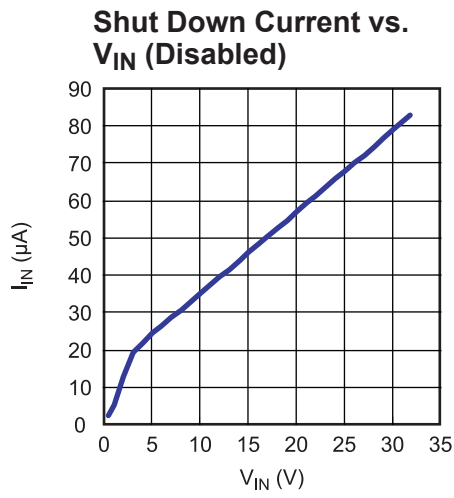

**BLOCK DIAGRAM**

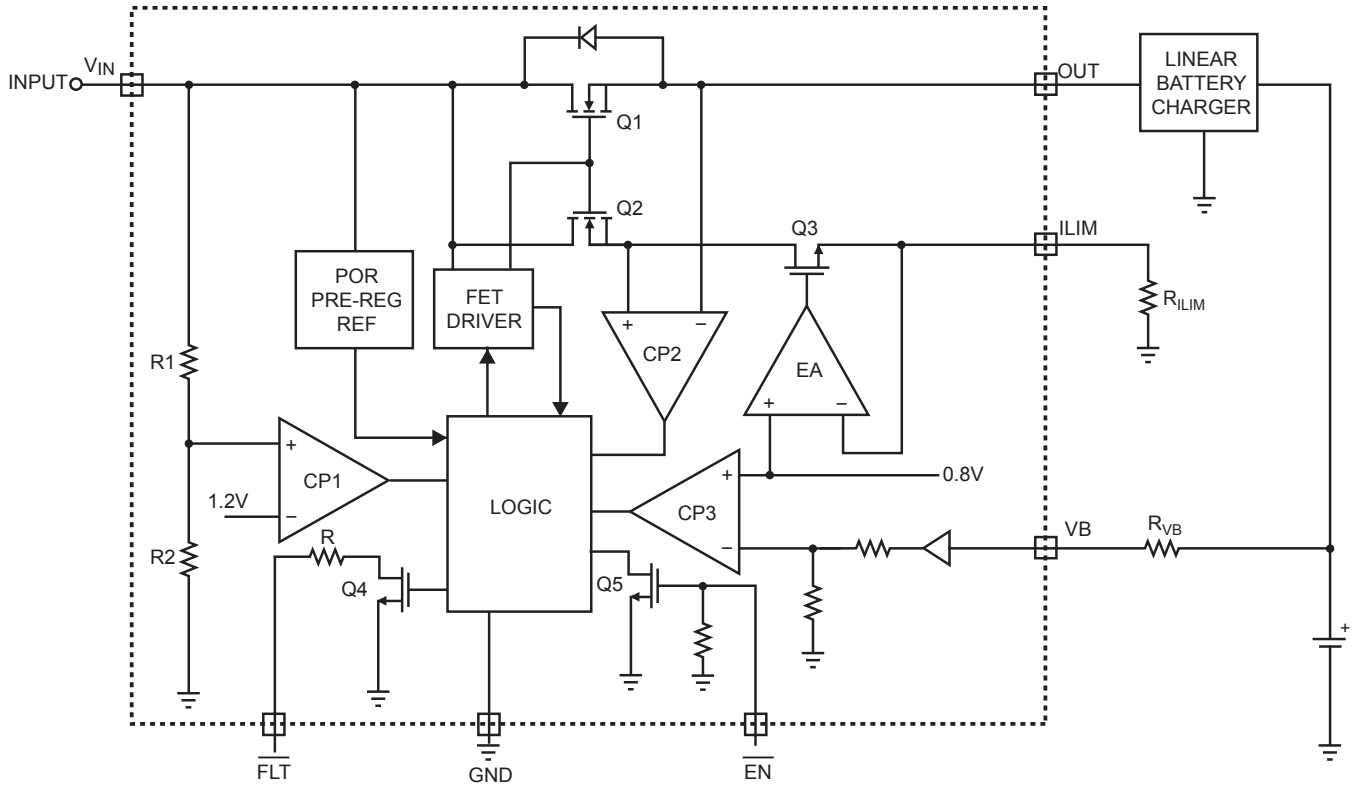

**Figure 1—Functional Block Diagram**

## OPERATION

The MP2670 is designed to provide a redundant safety protection to a Li-Ion battery from failures of the charging system. The IC continuously monitors the input voltage, the battery voltage, and the charge current. When any of the above three parameters exceeds its limit, the IC turns off an internal N-channel MOSFET to remove the power from the charging system. The threshold of charge current protection is user-programmable. Additionally, the IC also monitors its own die temperature and turns off the N-channel MOSFET if the temperature exceeds 150°C. Together with the battery charging IC and the protection module in a battery pack, the charging system has triple-level protection from over-charging the Li-Ion battery and is two-fault tolerant. The MP2670 protects up to 30V input voltage.

### Power Up

The MP2670 has a power-on reset (POR) threshold of 2.6V with a built-in hysteresis of 110mV. When the input voltage is below the POR threshold, the internal power FET is off. The IC resets itself and waits for approximately 10ms after the input voltage exceeds the POR threshold, then, if the input voltage and battery voltage are safe, the IC begins to soft-start the internal power FET. The 10ms delay allows any transient at the input during a hot insertion of the power supply to settle down before the IC starts to operate. The soft-start slowly turns on the power FET to reduce the inrush current as well as the input voltage drop during the transition.

### Input Over-voltage Protection (OVP)

The input voltage is continuously monitored by the comparator CP1 in the Block Diagram (Figure 1). The OVP threshold is set by a resistive divider consisting of R1 and R2 and an accurate reference generated by the IC itself. The protection threshold is set to 5.8V. When the input voltage exceeds the threshold, the CP1 outputs a logic signal to turn off the power FET within 1µs to prevent the high input voltage from damaging the electronics in the handheld system. The hysteresis for the input OVP threshold is given in the Electrical Specification.

When the input over-voltage condition is removed, the power FET is turned on again by running through the soft-start. Because of the 10ms second delay before the soft-start, the output is never enabled if the input rises above the OVP threshold quickly.

### Over-current Protection (OCP)

The current in the power FET is limited to prevent charging the battery with an excessive current. The current is sensed using the voltage drop across the power FET after the FET is turned on. The reference of the OCP is generated using a sensing FET Q2, as shown in Figure 1. The current in the sensing FET is forced to a value which can be programmed by an external resistor connected to the ILIM pin. The size of the power FET Q1 is 31,250 times the size of the sensing FET Q2. Therefore, when the current in the power FET is 31,250 times the current in the sensing FET, the drain voltage of the power FET falls below that of the sensing FET. The comparator CP2 then outputs a signal to turn off the power FET. The OCP threshold can be programmed using the following formula:

$$I_{LIM} (A) = \frac{0.8V}{R_{ILIM} (\Omega)} \times 31250 = \frac{25000}{R_{ILIM} (\Omega)}$$

The OCP comparator CP2 has a built-in 170µs delay to prevent false triggering by transient signals. When OCP happened, Vo shuts down for about 40ms and take 10ms delay to soft start as the OCP condition is removed. The OCP function also has a 4-bit binary counter that accumulates during an OCP event. When the total count reaches 16, the power PFET is turned off permanently unless the input power is recycled or the enable pin is toggled.

### Battery Over-voltage Protection (BOVP)

The battery voltage OVP threshold is internally set to 4.4V. The threshold has 75mV built-in hysteresis. The comparator CP3, as shown in Figure 1, monitors the VB pin and issues an over-voltage signal to turn off the internal power FET when the battery voltage exceeds the battery OVP threshold. The comparator CP3 has a built-in 180 $\mu$ s blanking time to prevent any transient voltage from triggering the OVP. If the OVP situation still exists after the blanking time, the power FET is turned off. There is an internal 4-bit binary counter monitoring the occurrences of the battery over-voltage event. If the battery over-voltage occurs 16 times, the power FET is turned off permanently. Recycling the input power or toggling the enable ( $\overline{\text{EN}}$ ) input will reset the counter and restart the MP2670.

The resistor between the VB pin and the battery,  $R_{\text{VB}}$ , as shown in the Typical Applications circuit, is an important component. This resistor provides a current limit in case the VB pin is shorted to the input voltage under a failure mode. The VB pin leakage current under normal operation is negligible to allow a resistance of 200k $\Omega$  to 1M $\Omega$  being used.

### Thermal Protection

The MP2670 monitors its own die temperature to prevent thermal failures. When the internal temperature reaches 150°C, the internal N-channel power MOSFET is turned off. The IC does not resume operation until the internal temperature drops below 110°C.

### External Enable Function

The MP2670 offers an enable ( $\overline{\text{EN}}$ ) input which can be used to enable or disable the IC. When the  $\overline{\text{EN}}$  pin is pulled to logic HIGH, the protection IC is shut down. The internal control circuit as well as the power FET is turned off. Both 4-bit binary counters for the battery OVP and the OCP are reset to zero when the IC is re-enabled. The  $\overline{\text{EN}}$  pin has an internal 200k $\Omega$  pull-down resistor. Leaving the  $\overline{\text{EN}}$  pin floating or driving it to below 0.4V enables the IC.

### Warning Indication Output

The  $\overline{\text{FLT}}$  pin is an open-drain output that indicates a LOW signal when any of the three protection events happens. To pull the FLT pin voltage low when fault, a recommended 10k $\Omega$  to 200k $\Omega$  resistor should be used as the pull up resistor.

## APPLICATION INFORMATION

For safe and effective charging, some strict requirements have to be satisfied during charging Li-Ion batteries such as high precise power source for charging ( $4.2V \pm 50mV$ ), the accuracy should be higher than 1%. For highly used capacity, the voltage of the battery should be charged to the value (4.2V) as possible as could. Otherwise, the performance and the life of the battery suffers overcharge. Additionally, the pre-charge for depleted batteries, charging voltage, charging current, as well as the temperature detection and protection, are required for linear battery chargers. The output of most MPS linear charger has a typical I-V curve and provides overcharge, input over voltage, over temperature protection. The function of the MP2670 is to add a redundant protection layer such that, under any fault condition, the charging system output does not exceed the I-V limits that the battery required. Additionally, MP2670 provides full protection for these chargers whose protection function is not so complete especially those without input surge voltage sustain. MP2670 guarantees the safety of the charge system with its perfect 4 protection functions: OVP, BOVP, OCP and OTP

The MP2670 is a simple device that requires few external components, in addition to the linear charger circuit as shown in the Typical Application Circuit. The selection of MP2670's external components is shown as follow, and the selection of the current limit resistor  $R_{LIM}$  has been introduced in the Over-current Protection section.

### $C_{IN}$ and $C_{OUT}$ Selection

The input capacitor ( $C_{IN}$ ) is for decoupling. Higher value of  $C_{IN}$  reduces the voltage drop or the over shoot during transients. The AC adapter is inserted live (hot insertion) and sudden step down of the current in the power FET will cause the input voltage overshoot.

During an input OVP, the FET is turned off in less than  $1\mu s$  and can lead to significant over shoot. Higher capacitance of  $C_{IN}$  reduces this type of over shoot. However, the over shoot caused by a hot insertion is not very dependent on the decoupling capacitance value. Usually,

the input decoupling capacitor is recommended to use a dielectric ceramic capacitor with a value between  $1\mu F$  to  $4.7\mu F$ .

The output of the MP2670 and the input of the charging circuit typically share one decoupling capacitor. The selection of that capacitor is mainly determined by the requirement of the charging circuit. When using the MP2602 family chargers, a  $1\mu F$  to  $4.7\mu F$  ceramic capacitor is recommended.

### $R_{VB}$ Selection

$R_{VB}$  limits the current from the VB pin to the battery terminal in case the MP2670 fails. The recommended value is between  $200k\Omega$  to  $1M\Omega$ . With  $200k\Omega$  resistance, during the failure operation, assuming the VB pin voltage is 30V and the battery voltage is 4.2V. The worst case the current flowing from the VB pin to the charger output is,

$$(30V - 4.2V)/200k\Omega = 130\mu A,$$

Such small current can be easily absorbed by the bias current of other components. Increasing the  $R_{VB}$  value reduces the worst case current, but at the same time increases the error for the 4.4V battery OVP threshold.

As the typical VB pin leakage current is 20nA, the error of the battery OVP threshold can be calculated as  $4.4V + 20nA \times R_{VB}$ . With the  $200k\Omega$  resistor, the worst-case additional error is 4mV and with a  $1M\Omega$  resistor, the worst-case additional error is 20mV.

**PACKAGE INFORMATION**

**QFN10 (3mmx3mm)**

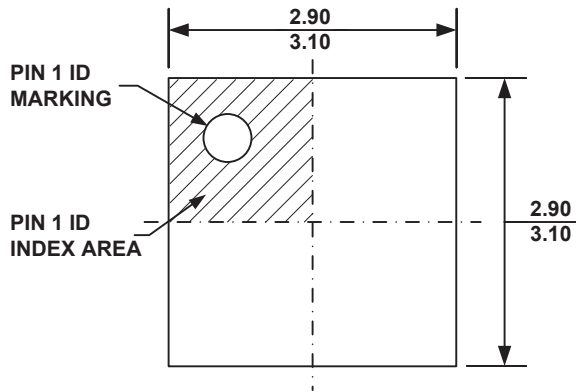

**TOP VIEW**

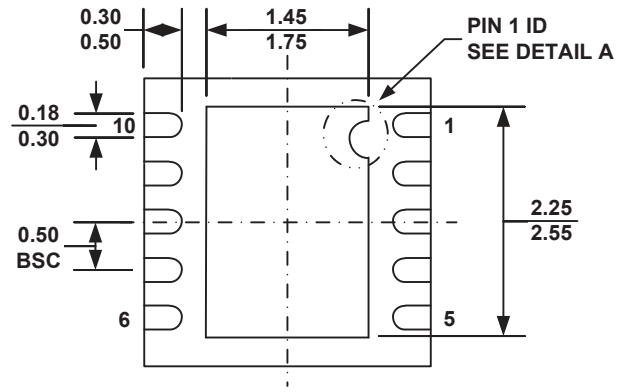

**BOTTOM VIEW**

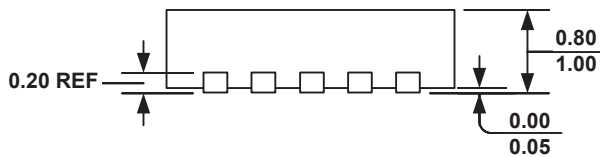

**SIDE VIEW**

**PIN 1 ID OPTION A  
R0.20 TYP.**

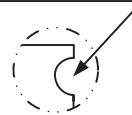

**PIN 1 ID OPTION B  
R0.20 TYP.**



**DETAIL A**

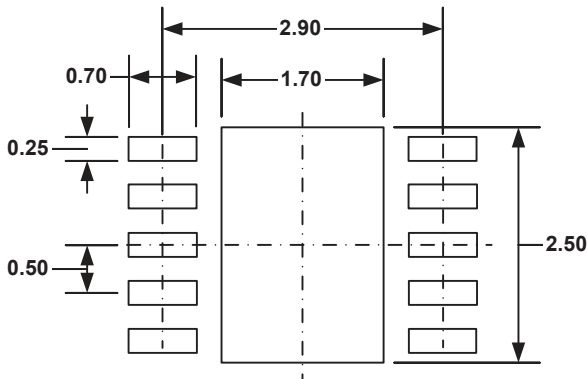

**RECOMMENDED LAND PATTERN**



**NOTE:**

- 1) ALL DIMENSIONS ARE IN MILLIMETERS.
- 2) EXPOSED PADDLE SIZE DOES NOT INCLUDE MOLD FLASH.
- 3) LEAD COPLANARITY SHALL BE 0.10 MILLIMETER MAX.
- 4) DRAWING CONFORMS TO JEDEC MO-229, VARIATION VEED-5.
- 5) DRAWING IS NOT TO SCALE.

**NOTICE:** The information in this document is subject to change without notice. Users should warrant and guarantee that third party Intellectual Property rights are not infringed upon when integrating MPS products into any application. MPS will not assume any legal responsibility for any said applications.

## Looking for pricing, stock, or lifecycle information?

Click below to explore more details on WIN SOURCE:

-  [View MP2104DJ-LF-Z on WIN SOURCE](#)
-  [Monolithic Power Systems Inc. Information](#)

## Optimize Your Supply Chain with WIN SOURCE Solutions

-  Global Sourcing Solution
-  Obsolete Management
-  Cost Control Management
-  Shortage Management
-  Alternative Solution
-  Excess Inventory Management