



**THE DATASHEET OF  
MP28119EG-LF-Z**



### DESCRIPTION

The MP5000A is a protection device designed to protect circuitry on the output (source) from transients on input ( $V_{CC}$ ). It also protects  $V_{CC}$  from undesired shorts and transients coming from the source.

At start up, inrush current is limited by limiting the slew rate at the source. The slew rate is controlled by a small capacitor at the dv/dt pin. The dv/dt pin has an internal circuit that allows the customer to float this pin (no connect) and still receive 0.9ms ramp time at the source.

The maximum load at the output (source) is current limited. This is accomplished by utilizing a sense FET topology. The magnitude of the current limit is controlled by an external resistor from the I-Limit pin to the Source pin.

An internal charge pump drives the gate of the power device, allowing a very low on-resistance DMOS power FET of just 40m $\Omega$ .

The source is protected from the  $V_{CC}$  input being too low or too high. Under Voltage Lockout (UVLO) assures that  $V_{CC}$  is above the minimum operating threshold, before the power device is turned on. If  $V_{CC}$  goes above the high output threshold, the source voltage will be limited.

### FEATURES

- Integrated 40m $\Omega$  Power FET
- Enable/Fault Pin
- Adjustable Slew Rate for Output Voltage
- Adjustable Current Limit: 1-5A
- Thermal Protection
- Over Voltage Limit
- Low Inrush Current

### APPLICATIONS

- Hot Swap
- PC Cards
- Laptops

All MPS parts are lead-free and adhere to the RoHS directive. For MPS green status, please visit MPS website under Products, Quality Assurance page. "MPS" and "The Future of Analog IC Technology" are registered trademarks of Monolithic Power Systems, Inc.

### TYPICAL APPLICATION

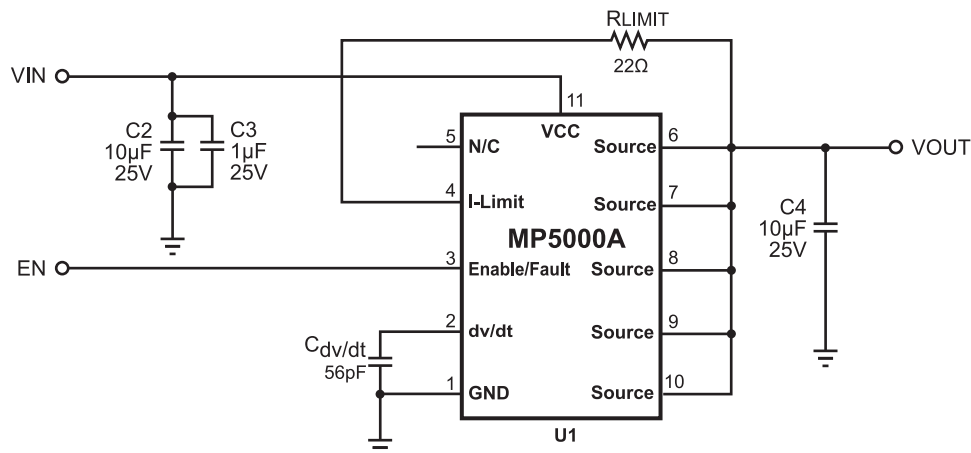

### ORDERING INFORMATION

Part Number*	Package	Top Marking
MP5000ADQ	QFN-10 (3mmX3mm)	See <i>Blow</i>

\* For Tape & Reel, add suffix –Z (e.g. MP5000ADQ–Z);  
 For RoHS Compliant Packaging, add suffix –LF (e.g. MP5000ADQ–LF–Z)

### TOP MARKING

AHQY  
 LLL

AHQ: product code of MP5000ADQ;  
 Y: year code;  
 LLL: lot number;

### PACKAGE REFERENCE

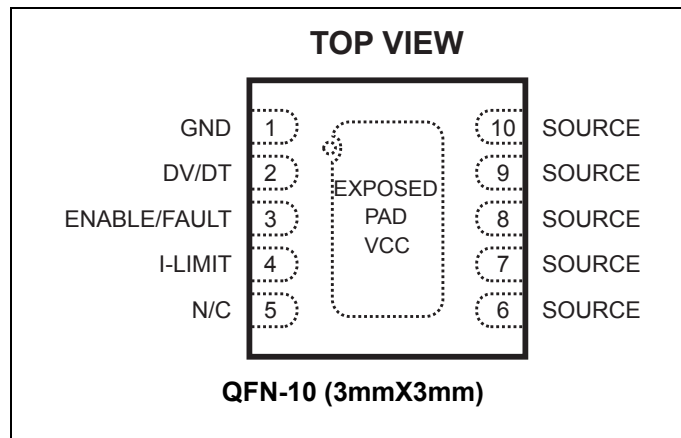

**ABSOLUTE MAXIMUM RATINGS** <sup>(1)</sup>

V <sub>CC</sub> , SOURCE, I-LIMIT .....	-0.3V to 22V
dv/dt, ENABLE/FAULT .....	-0.3V to 6V
Storage Temperature.....	-65°C to +155°C
Continuous Power Dissipation (T <sub>A</sub> = +25°C) <sup>(2)</sup>	2.5W
Operating Junction Temperature.	-40°C to 150°C
Input Voltage Transient (100mS) .....	V <sub>IN</sub> =25V

**Recommended Operating Conditions** <sup>(3)</sup>

Input Voltage Operating Range.....	10V to 18V
Continuous Current	
0.5 in <sup>2</sup> pad .....	4.2A
For Minimum Copper, T <sub>A</sub> =80°C .....	2.3A
Operating Junction Temp. (T <sub>J</sub> ).	-40°C to +125°C

<b>Thermal Resistance</b> <sup>(4)</sup>	<b>θ<sub>JA</sub></b>	<b>θ<sub>JC</sub></b>
QFN-10 (3mmX3mm) .....	50	12... °C/W

**Notes:**

- 1) Exceeding these ratings may damage the device.
- 2) The maximum allowable power dissipation is a function of the maximum junction temperature T<sub>J</sub>(MAX), the junction-to-ambient thermal resistance θ<sub>JA</sub>, and the ambient temperature T<sub>A</sub>. The maximum allowable continuous power dissipation at any ambient temperature is calculated by P<sub>D</sub>(MAX)=(T<sub>J</sub>(MAX)-T<sub>A</sub>)/ θ<sub>JA</sub>. Exceeding the maximum allowable power dissipation will cause excessive die temperature, and the regulator will go into thermal shutdown. Internal thermal shutdown circuitry protects the device from permanent damage.
- 3) The device is not guaranteed to function outside of its operating conditions.
- 4) Measured on JESD51-7, 4-layer PCB.

## ELECTRICAL CHARACTERISTICS

$V_{CC} = 12V$ ,  $R_{LIMIT}=22\Omega$ , Capacitive Load =  $100\mu F$ ,  $T_A=25^\circ C$ , unless otherwise noted.

Parameters	Symbol	Condition	Min	Typ	Max	Units
<b>Power FET</b>						
Delay Time <sup>(5)</sup>	$t_{DLY}$	Enabling of chip to $I_D=100mA$ with a 1A resistive load		0.4		ms
ON Resistance	$R_{DSon}$	$T_J=25^\circ C$		40	55	m $\Omega$
		$T_J=85^\circ C$ <sup>(6)</sup>		52		
Off State Output Voltage	$V_{OFF}$	$V_{CC}=18Vdc$ , $V_{ENABLE}=0Vdc$ , $R_L=500\Omega$			120	mV
<b>Thermal Latch</b>						
Shutdown Temperature <sup>(6)</sup>	$T_{SD}$			175		$^\circ C$
<b>Under/Over Voltage Protection</b>						
Output Clamping Voltage	$V_{CLAMP}$	Overvoltage Protection $V_{CC}=17V$	13.8	15	16.2	V
Under Voltage Lockout	$V_{UVLO}$	Turn on, Voltage going high	7.7	8.5	9.3	V
Under Voltage Lockout (UVLO) Hysteresis	$V_{HYST}$			0.80		V
<b>Current Limit</b>						
Hold Current <sup>(7)</sup>	$I_{LIM-SS}$	$R_{LIM}=22\Omega$	2.3	3.6	4.9	A
Trip Current <sup>(7)</sup>	$I_{LIM-OL}$	$R_{LIM}=22\Omega$		4.7		A
<b>dv/dt Circuit</b>						
Rise Time	$T_r$	Float dv/dt pin, Output rises from 10% to 90%	0.4	0.9	2.1	ms
<b>Enable/Fault</b>						
Low Level Input Voltage	$V_{IL}$	Output Disabled			0.5	V
Intermediate Level Input Voltage	$V_{I(INT)}$	Thermal Fault, Output Disabled	0.82	1.4	1.95	V
High Level Input Voltage	$V_{IH}$	Output Enabled	2.5			V
High State Maximum Voltage	$V_{I(MAX)}$			5		V
Low Level Input Current (Sink)	$I_{IL}$	$V_{ENABLE}=0V$		-28	-50	$\mu A$
Maximum Fanout for Fault Signal		Total number of chips that can be connected for simultaneous shutdown			3	Units
Maximum Voltage on Enable/Fault Pin <sup>(8)</sup>	$V_{MAX}$				$V_{CC}$	V
<b>Total Device</b>						
Bias Current	$I_{BIAS}$	Device Operational		1	1.2	mA
		Thermal Shutdown		0.4		
Minimum Operating Voltage for UVLO	$V_{MIN}$	Enable<0.5V			5	V

**Notes:**

- 5) Related to Rise Time. See description in Fault and Enable Pin Section.
- 6) Guaranteed by design.
- 7) Guaranteed by characterization Test.
- 8) Maximum Input Voltage on Enable pin to be  $\leq 6.0V$  if  $V_{CC} \geq 6.0V$ , Maximum Input Voltage on Enable pin to be  $V_{CC}$  if  $V_{CC} \leq 6.0V$ .

## PIN FUNCTIONS

Pin #	Name	Description
1	GND	Negative Input Voltage to the Device. This is used as the internal reference for the IC.
2	dv/dt	The internal dv/dt circuit controls the slew rate of the output voltage at turn on. It has an internal capacitor that allows it to ramp up over the period of 0.9ms. An external capacitor can be added to this pin to increase the ramp time. If an additional time delay is not required, this pin should be left open.
3	Enable/Fault	The Enable/Fault pin is a tri-state, bi-directional interface. It can be used to enable the output of the device by floating the pin, or disable the chip by pulling it to ground (using an open drain or open collector device). If a thermal fault occurs, the voltage on this pin will go to an intermediate state to signal a monitoring circuit that the device is in thermal shutdown. See text: "ENABLE/FAULT PIN".
4	I-Limit	A resistor between this pin and the Source pin sets the overload and short circuit current limit levels.
5	N/C	DO NOT CONNECT. Pin must be left floating.
6-10	SOURCE	This pin is the source of the internal power FET and the output terminal of the IC.
11	V <sub>CC</sub> (Exposed Pad)	Positive input voltage to the device (exposed pad).

## TYPICAL PERFORMANCE CHARACTERISTICS

$V_{IN} = 12V$ ,  $V_{EN} = 3.3V$ ,  $R_{LIMIT} = 22\Omega$ ,  $C_{OUT} = 10\mu F$ ,  $C_{dv/dt} = 1nF$ ,  $T_A = 25^\circ C$ , unless otherwise noted.

**Supply Current, Output Enabled vs. Input Voltage**

$V_{EN} = 3.3V$ , no load

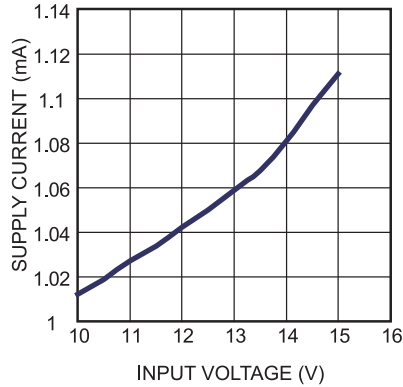

**Supply Current, Output Disabled vs. Input Voltage**

$V_{EN} = 0V$

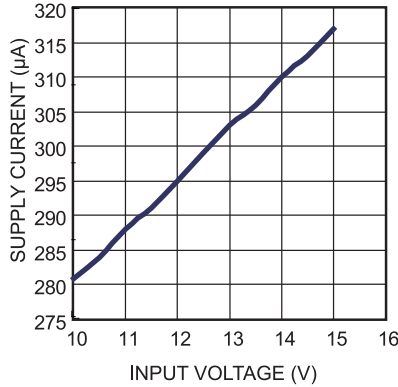

**Static Drain-Source On-State Resistance vs. Input Voltage**

$I_{OUT} = 1A$

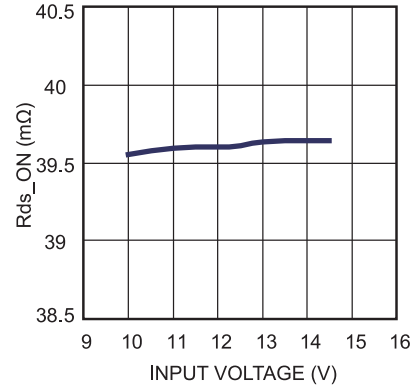

**Input to Output Voltage vs. Load Current**

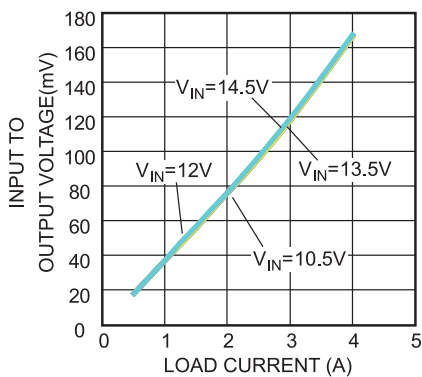

**Hold Current vs. Input Voltage**

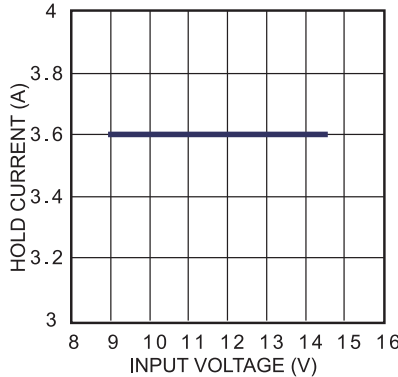

**Trip Current Vs. Input Voltage**

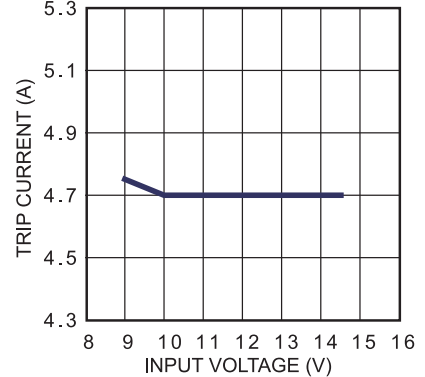

**Current Limit Response vs. Peak Current**

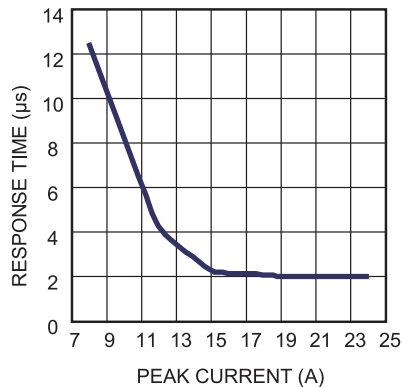

**Trip Current and Hold Current vs.  $R_{LIMIT}$**

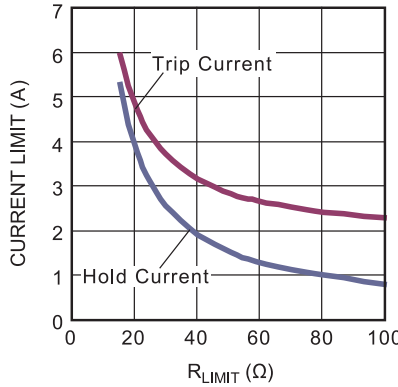

**TYPICAL PERFORMANCE CHARACTERISTICS (continued)**
 $V_{IN} = 12V, V_{EN} = 3.3V, R_{LIMIT} = 22\Omega, C_{OUT} = 10\mu F, C_{dv/dt} = 1nF, T_A = 25^\circ C$ , unless otherwise noted.

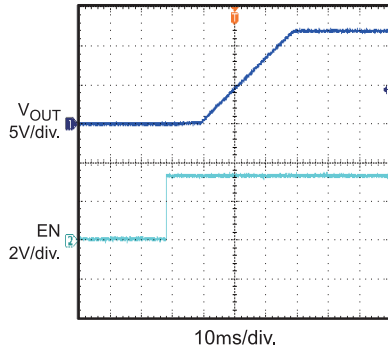
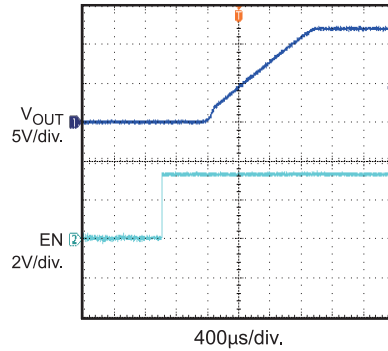
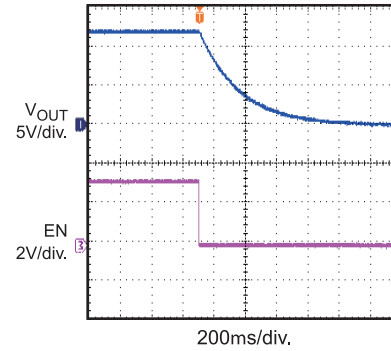
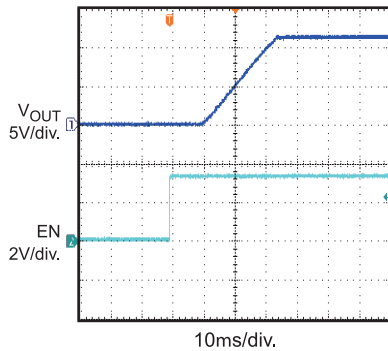
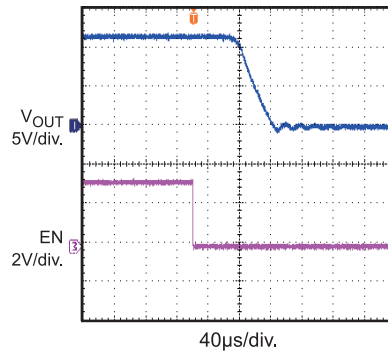
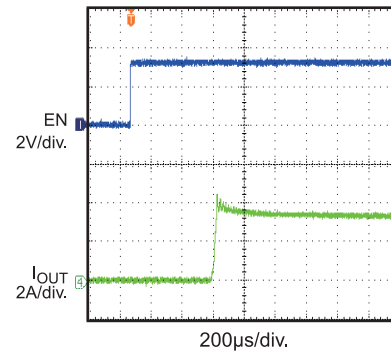
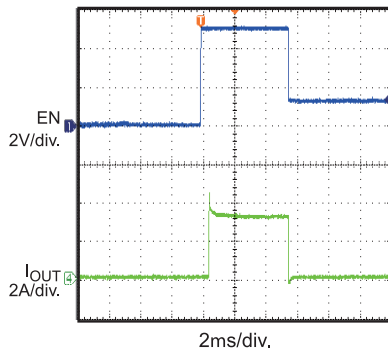
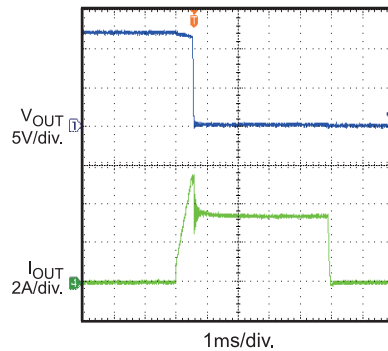
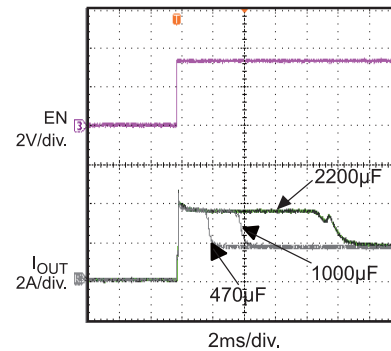
**Turn On Delay and Rise Time With 1 $\mu$ F Load**
 $C_{OUT} = 1\mu F, \text{No Load}, C_{dv/dt} = 1nF$ 

**Turn On Delay and Rise Time with 1 $\mu$ F Load**
 $C_{OUT} = 1\mu F, \text{No Load}, C_{dv/dt} = 0$ 

**Turn Off Delay and Fall Time With 1 $\mu$ F Load**
 $C_{OUT} = 1\mu F, \text{No Load}, C_{dv/dt} = 1nF$ 

**Turn On Delay and Rise Time With 10 $\mu$ F Load**
 $R_{LOAD} = 3.9\Omega, C_{OUT} = 10\mu F$ 

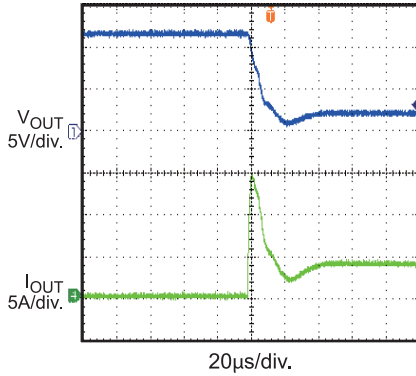
**Turn Off Delay and Fall Time With 10 $\mu$ F Load**
 $R_{LOAD} = 3.9\Omega, C_{OUT} = 10\mu F$ 

**Short Circuit Current Device Enabled Into Short**
 $C_{dv/dt} = 0$ 

**Short Circuit Current Device Enabled Into Short and Thermal Shut Down (EN Floating)**
 $C_{dv/dt} = 0$ 

**Trip Current With Ramped Load On Enabled Device (0.01A/µs)**

**Inrush Current With Different Load Capacitance**
 $R_{LOAD} = 7.3\Omega, C_{dv/dt} = 0, \text{EN Start Up}$ 

**TYPICAL PERFORMANCE CHARACTERISTICS** *(continued)*

$V_{IN} = 12V$ ,  $V_{EN}=3.3V$ ,  $R_{LIMIT}=22\Omega$ ,  $C_{OUT}=10\mu F$ ,  $C_{dv/dt}=1nF$ ,  $T_A=25^\circ C$ , unless otherwise noted.

**0.6Ω Load Connected To Enabled Device**



**0.3Ω Load Connected To Enabled Device**

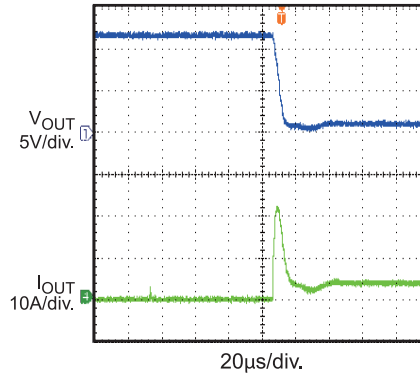

**Current Limit  $R_{LIMIT}=51\Omega$**

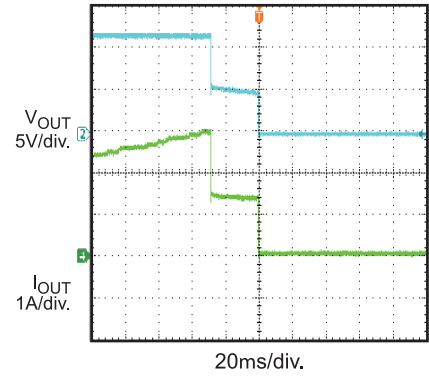

**BLOCK DIAGRAM**

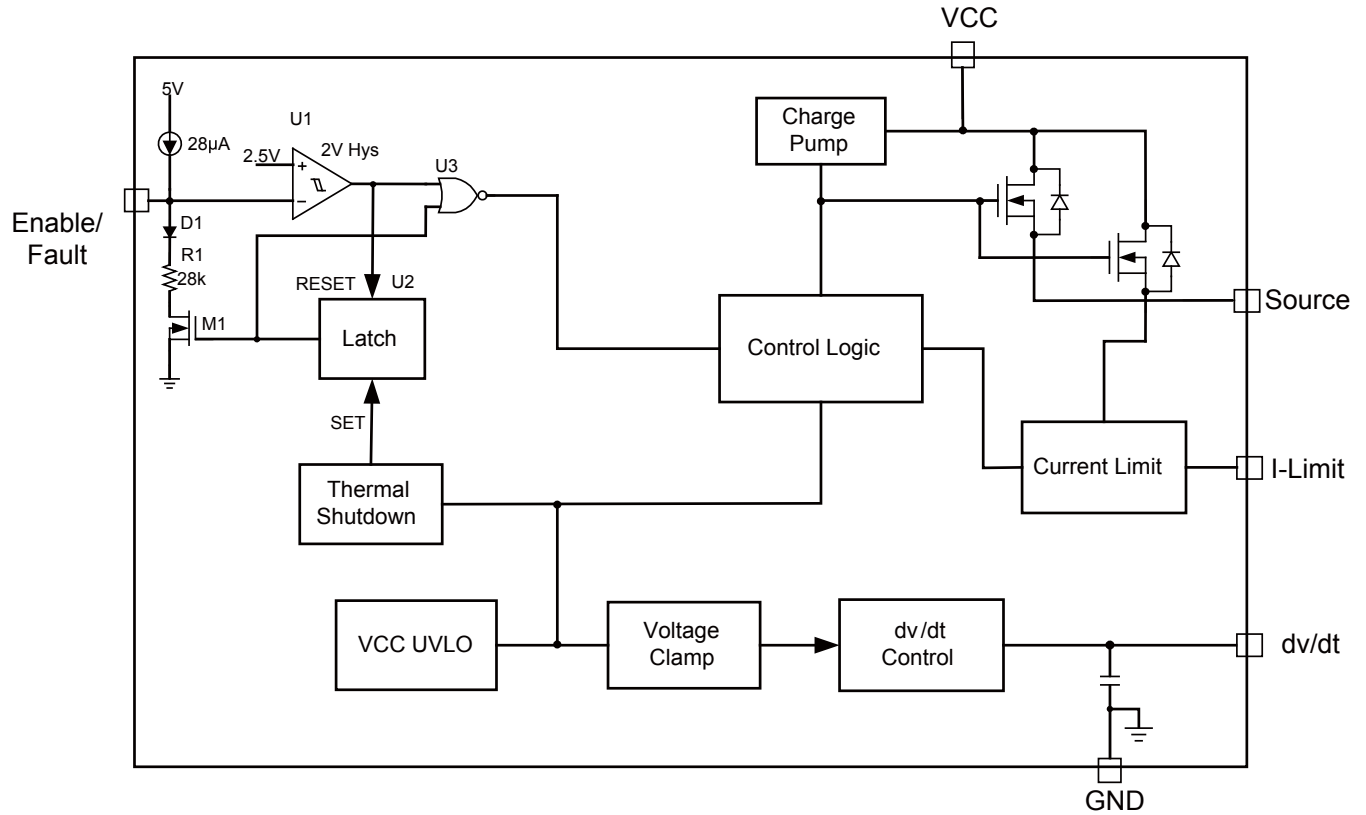

**Figure 1—Function Block Diagram**

## OPERATION

The MP5000A is designed to limit the in-rush current to the load. It offers an integrated solution to monitor the input voltage, output voltage, output current and die temperature.

### Under Voltage Lock Out Operation

If the supply (input) is below the UVLO threshold, the output is disabled, and the fault line is driven low.

When the supply goes above the UVLO threshold, the output is enabled and the fault line is released. When the fault line is released it will be pulled high by a 28uA current source. No external pull up resistor is required. In addition, the pull up voltage is limited to 5 volts.

### Output Over Voltage Protection

If the input voltage is higher than the OVP threshold, the output will be clamped at 15V (typical).

### Current Limit

When the part is active, if load reaches trip current (minimum threshold current triggering over current protection) or a short is present, the part switches into to a constant-current (hold current) mode. Part will be shutdown only if the over current condition stays long enough to trigger thermal protection.

However, when the part is powered up by  $V_{CC}$  or EN, the load current should be smaller than hold current. Otherwise, the part can't be fully turned on.

In a typical application using a current limit resistor of 22Ω, the trip current will be 4.7A and the hold current will be 3.6A. If the device is in its normal operating state and passing 2.0A it will need to dissipate only 160mw with the very low on resistance of 40mΩ. For the package dissipation of 50°C/Watt, the temperature rise will only be + 8°C. Combined with a 25°C ambient, this is only 33°C total package temperature.

During a short circuit condition, the device now has 12V across it and the hold current clamps at 3.6A and therefore must dissipate 43W. At 50°C/watt, if uncontrolled, the temperature would rise above the MP5000A thermal protection

(+175°C) and shutdown the device to cause the temperature to drop below a hysteresis level. Proper heat sink must be used if the device is intended to supply the hold current and not shutdown. Without a heat sink, hold current should be maintained below 250mA at + 25°C and below 150mA at +85°C to prevent the device from activating the thermal shutdown feature.

### Thermal protection

When thermal protection is triggered, the output is disabled and the fault line is driven to the middle level. The thermal fault condition is latched, and the part will remain latch off state until restart the power or reset the enable pin.

### Enable / Fault Pin

The Enable/Fault Pin is a Bi-Directional three levels I/O with a weak pull up current (28uA typical). The three levels are low, mid and high. It functions to enable/disable the part and to relay Fault information.

Enable/Fault pin as an input:

1. Low and mid disable the part.
2. Low, in addition to disabling the part, clears the fault flag.
3. High enables the part (if the fault flag is clear) after a delay time. The delay time can be calculated by:

$$T_{\text{delay}} = 80\mu\text{s} + \frac{1}{3}t_{\text{rise}}$$

Enable/Fault pin as an output:

1. The pull up current may (if not over ridden) allow a "wired nor" pull up to enable the part.
2. An under voltage will cause a low on the Enable/Fault pin, and will clear the fault flag.
3. A thermal fault will cause a mid level on the Enable/Fault pin, and will set the fault flag.

The Enable/Fault line must be above the mid level for the output to be turned on.

The fault flag is an internal flip-flop that can be set or reset under various conditions:

1. Thermal Shutdown: set fault flag
2. Under Voltage: reset fault flag
3. low voltage on Enable/Fault pin: reset fault flag
4. mid voltage on Enable/Fault pin: no effect

There are 4 types of faults, and each fault has a direct and indirect effect on the Enable/Fault pin and the internal fault flag.

In a typical application there are one or more of the MP5000A chips in a system. The Enable/Fault lines will typically be connected together.

Under a fault, the Enable/Fault pin is driven to the mid level.

**Table 1—Fault Function Influence in Application**

Fault description	Internal action	Effect on Fault Pin	Effect on Flag	Effect on secondary Part
Short/over current	Limit current	none	none	none
Under Voltage	Output is turned off	Internally drives Enable/Fault pin to Logic low	Flag is reset	Secondary part output is disabled, and fault flag is reset.
Over Voltage	Limit output voltage	None	None	None
Thermal Shutdown	Shutdown part The part is latched off until a UVLO or externally driven to ground.	Internally drives Enable/Fault pin to mid level	Flag is set	Secondary part output is disabled.

## APPLICATION INFORMATION

### Current Limit

The desired current limit is a function of the external current limit resistor.

**Table 2—Current Limit vs. Current Limit Resistor**  
( $V_{CC}=12V$ )

$R_{LIMIT}$ ( $\Omega$ )	15.4	18.2	22	30	51	100
<b>Trip Current (A)</b>	5.93	5.26	4.70	3.71	2.84	2.28
<b>Hold Current (A)</b>	5.28	4.37	3.60	2.56	1.52	0.81

### Rise Time

The rise time is a function of the capacitor (Cdv/dt) on the dv/dt pin.

**Table 3—Rise Time vs. Cdv/dt**

Cdv/dt	none	50pF	500pF	1nF
<b>Rise Time (TYPICAL) (ms)</b>	0.9	2	12	23

\* Notes: Rise Time =  $K_{RT} * (41pF + C_{dv/dt})$ ,  $K_{RT} = 22E6$

The “rise time” is measured by from 0% to 100% of output voltage.

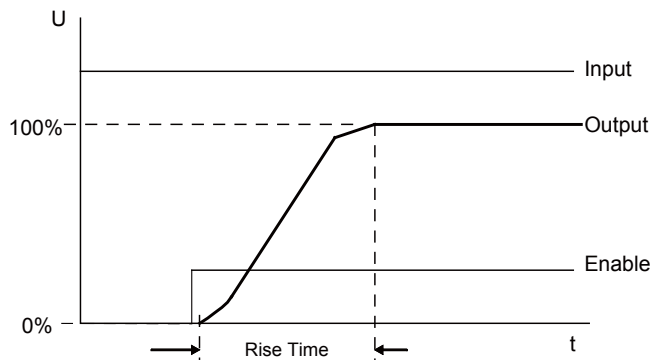

**Figure 2—Rise Time**

## PCB LAYOUT

PCB layout is very important to achieve stable operation. Please follow these guidelines and take below figure for reference. Place  $R_{LIMIT}$  close to  $I_{LIMIT}$  pin, Cdv/dt close to dv/dt pin and input cap close to  $V_{CC}$  pin. Keep the N/C pin float. Put vias in thermal pad and ensure enough copper area near  $V_{CC}$  and source to achieve better thermal performance.

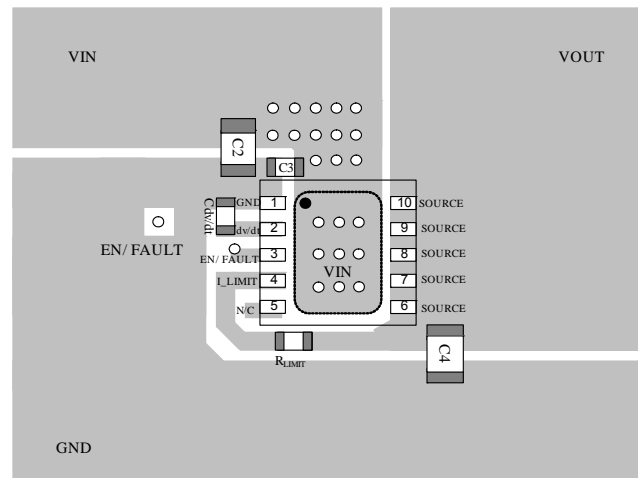

**Top Layer**

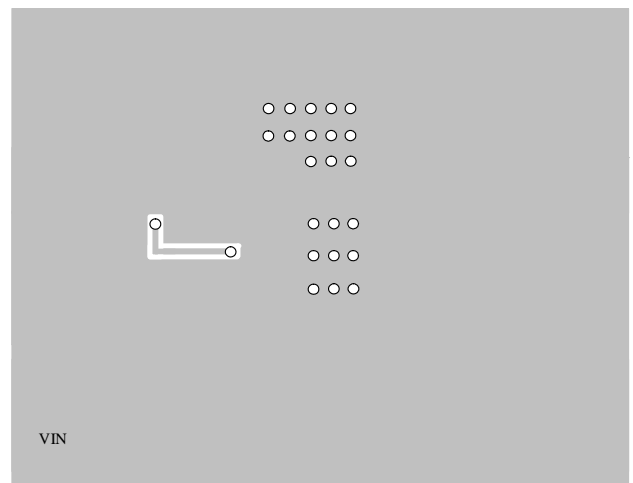

**Bottom Layer**

**Figure 3—PCB Layout**

**Design Example**

Below is a design example following the application guidelines for the given specifications:

**Table 4: Design Example**

<b>V<sub>IN</sub></b>	12V
<b>Trip Current</b>	4.7A
<b>Hold Current</b>	3.6A

Figure 4 shows the application schematic. The Typical Performance Characteristics section shows the circuit waveforms. For more device applications, please refer to the related Evaluation Board Datasheet.

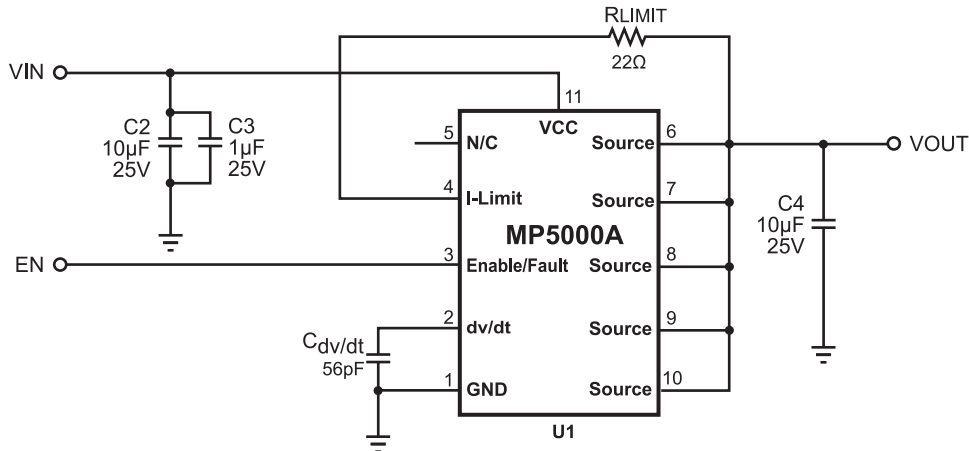
**TYPICAL APPLICATION CIRCUITS**

**Figure 4—Typical Application Schematic**

## PACKAGE INFORMATION

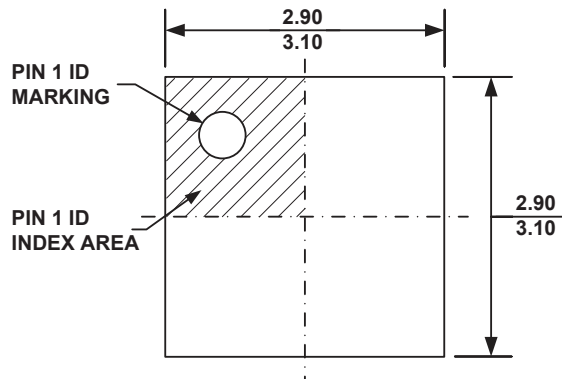
### QFN10 (3 x 3mm)

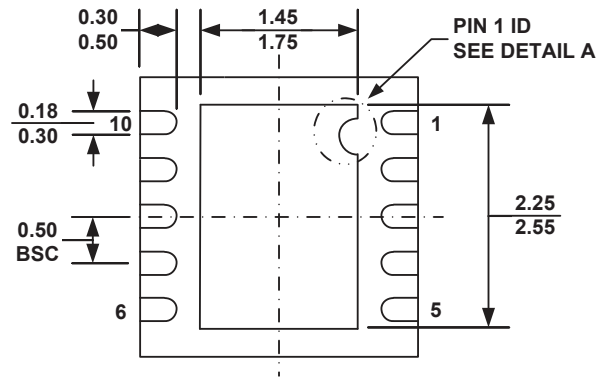

**TOP VIEW**



**BOTTOM VIEW**

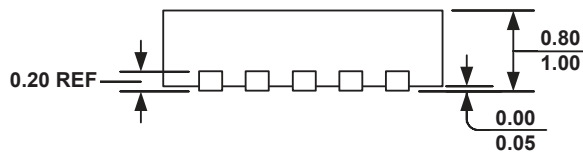

**SIDE VIEW**

**PIN 1 ID OPTION A**  
R0.20 TYP.

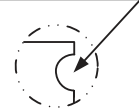

**PIN 1 ID OPTION B**  
R0.20 TYP.



**DETAIL A**

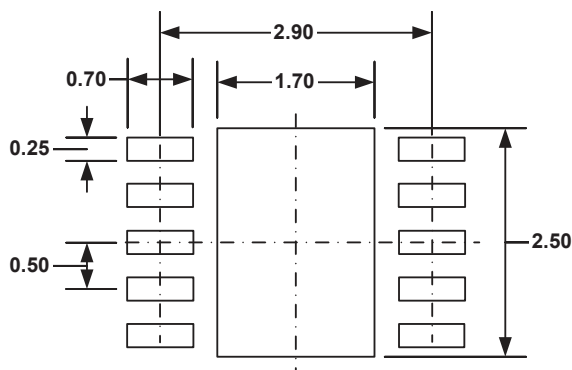

**RECOMMENDED LAND PATTERN**



#### NOTE:

- 1) ALL DIMENSIONS ARE IN MILLIMETERS.
- 2) EXPOSED PADDLE SIZE DOES NOT INCLUDE MOLD FLASH.
- 3) LEAD COPLANARITY SHALL BE 0.10 MILLIMETER MAX.
- 4) DRAWING CONFORMS TO JEDEC MO-229, VARIATION VEED-5.
- 5) DRAWING IS NOT TO SCALE.

**NOTICE:** The information in this document is subject to change without notice. Users should warrant and guarantee that third party Intellectual Property rights are not infringed upon when integrating MPS products into any application. MPS will not assume any legal responsibility for any said applications.

## Looking for pricing, stock, or lifecycle information?

Click below to explore more details on WIN SOURCE:

-  [View MP28119EG-LF-Z on WIN SOURCE](#)
-  [Monolithic Power Systems Inc. Information](#)

## Optimize Your Supply Chain with WIN SOURCE Solutions

-  Global Sourcing Solution
-  Obsolete Management
-  Cost Control Management
-  Shortage Management
-  Alternative Solution
-  Excess Inventory Management