



THE DATASHEET OF MPS6726G



MPS6726

One Watt Amplifier Transistors

PNP Silicon

Features

- This is a Pb-Free Device*

MAXIMUM RATINGS

| Rating | Symbol | Value | Unit |
|--|----------------|-------------|---------------------------|
| Collector - Emitter Voltage | V_{CEO} | -30 | Vdc |
| Collector - Base Voltage | V_{CBO} | -40 | Vdc |
| Emitter - Base Voltage | V_{EBO} | -5.0 | Vdc |
| Collector Current - Continuous | I_C | -1.0 | Adc |
| Total Device Dissipation @ $T_A = 25^\circ\text{C}$ Derate above 25°C | P_D | 1.0 8.0 | W mW/ $^\circ\text{C}$ |
| Total Device Dissipation @ $T_C = 25^\circ\text{C}$ Derate above 25°C | P_D | 2.5 20 | W mW/ $^\circ\text{C}$ |
| Operating and Storage Junction Temperature Range | T_J, T_{stg} | -55 to +150 | $^\circ\text{C}$ |

THERMAL CHARACTERISTICS

| Characteristic | Symbol | Max | Unit |
|---|-----------------|-----|---------------------------|
| Thermal Resistance, Junction-to-Ambient | $R_{\theta JA}$ | 125 | $^\circ\text{C}/\text{W}$ |
| Thermal Resistance, Junction-to-Case | $R_{\theta JC}$ | 50 | $^\circ\text{C}/\text{W}$ |

Stresses exceeding Maximum Ratings may damage the device. Maximum Ratings are stress ratings only. Functional operation above the Recommended Operating Conditions is not implied. Extended exposure to stresses above the Recommended Operating Conditions may affect device reliability.



ON Semiconductor®

<http://onsemi.com>

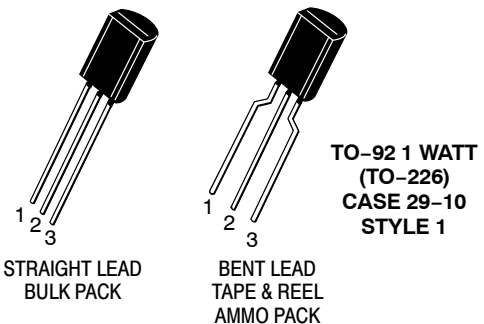
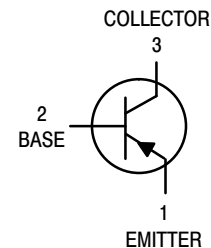

MARKING DIAGRAM

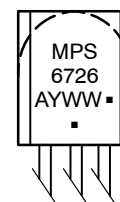

- A = Assembly Location
 - Y = Year
 - WW = Work Week
 - = Pb-Free Package
- (Note: Microdot may be in either location)

ORDERING INFORMATION

| Device | Package | Shipping [†] |
|----------|-----------------|-----------------------|
| MPS6726G | TO-92 (Pb-Free) | 5000 Units / Bulk |

*For additional information on our Pb-Free strategy and soldering details, please download the ON Semiconductor Soldering and Mounting Techniques Reference Manual, SOLDERRM/D.

MPS6726

ELECTRICAL CHARACTERISTICS (T_A = 25°C unless otherwise noted)

| Characteristic | Symbol | Min | Max | Unit |
|--|----------------------|----------|----------|------|
| OFF CHARACTERISTICS | | | | |
| Collector - Emitter Breakdown Voltage (I _C = -10 mA, I _E = 0) | V _{(BR)CEO} | -30 | - | Vdc |
| Collector - Base Breakdown Voltage (I _C = -100 μA, I _E = 0) | V _{(BR)CBO} | -40 | - | Vdc |
| Emitter - Base Breakdown Voltage (I _E = -100 μA, I _C = 0) | V _{(BR)EBO} | -5.0 | - | Vdc |
| Collector Cutoff Current (V _{CB} = -40 Vdc, I _E = 0) | I _{CBO} | - | -0.1 | μAdc |
| Emitter Cutoff Current (V _{EB} = -5.0 Vdc, I _C = 0) | I _{EBO} | - | -0.1 | μAdc |
| ON CHARACTERISTICS (Note 1) | | | | |
| DC Current Gain (I _C = -100 mA, V _{CE} = -1.0 Vdc) (I _C = -1000 mA, V _{CE} = -1.0 Vdc) | h _{FE} | 60 50 | - 250 | - |
| Collector - Emitter Saturation Voltage (I _C = -1000 mA, I _B = -100 mA) | V _{CE(sat)} | - | -0.5 | Vdc |
| Base - Emitter On Voltage (I _C = -1000 mA, V _{CE} = -1.0 Vdc) | V _{BE(on)} | - | -1.2 | Vdc |
| SMALL-SIGNAL CHARACTERISTICS | | | | |
| Collector - Base Capacitance (V _{CB} = -10 Vdc, I _E = 0, f = 1.0 MHz) | C _{cb} | - | 30 | pF |
| Small-Signal Current Gain (I _C = -50 mA, V _{CE} = -10 Vdc, f = 20 MHz) | h _{fe} | 2.5 | 25 | - |

1. Pulse Test: Pulse Width ≤ 300 μs; Duty Cycle ≤ 2.0%.

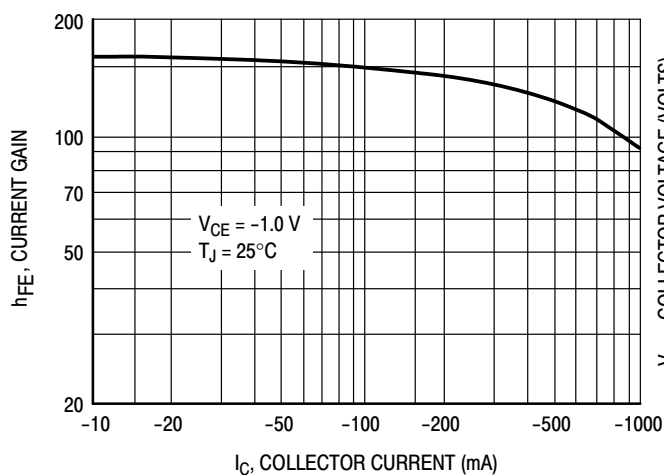

Figure 1. DC Current Gain

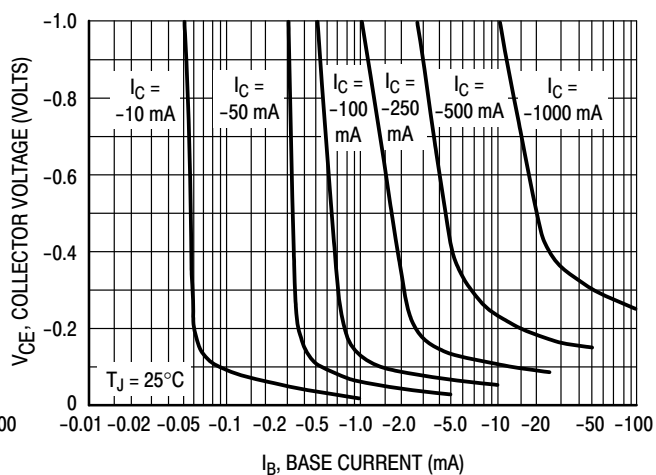

Figure 2. Collector Saturation Region

MPS6726

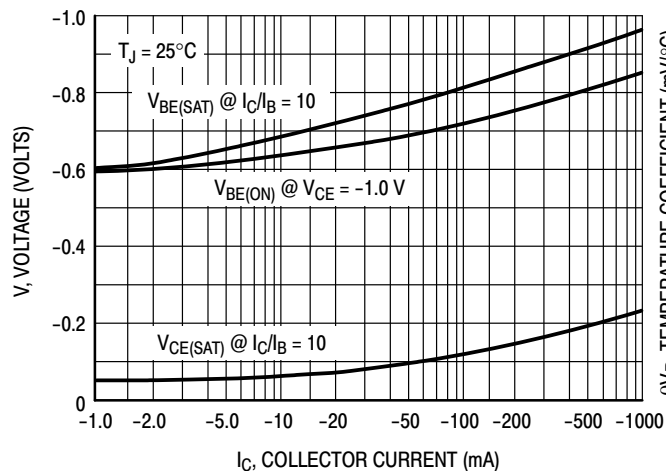

Figure 3. "ON" Voltages

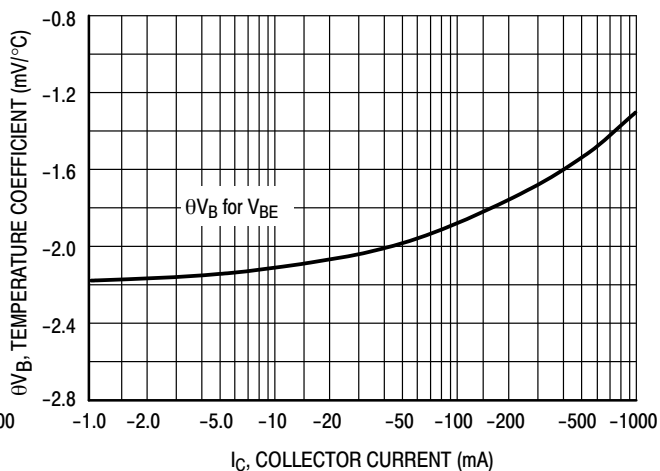

Figure 4. Temperature Coefficient

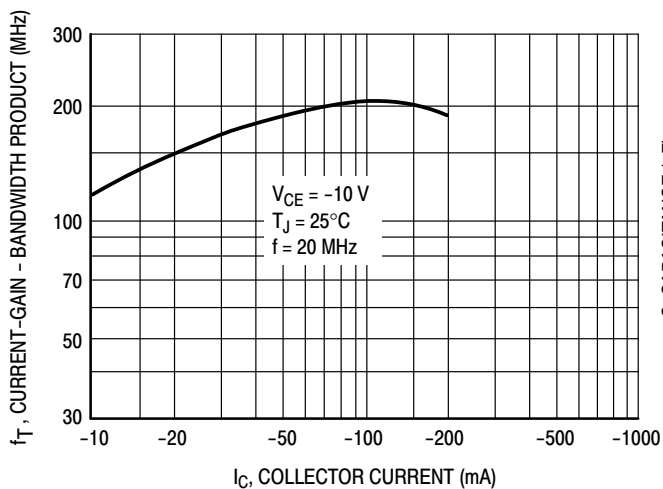

Figure 5. Current Gain — Bandwidth Product

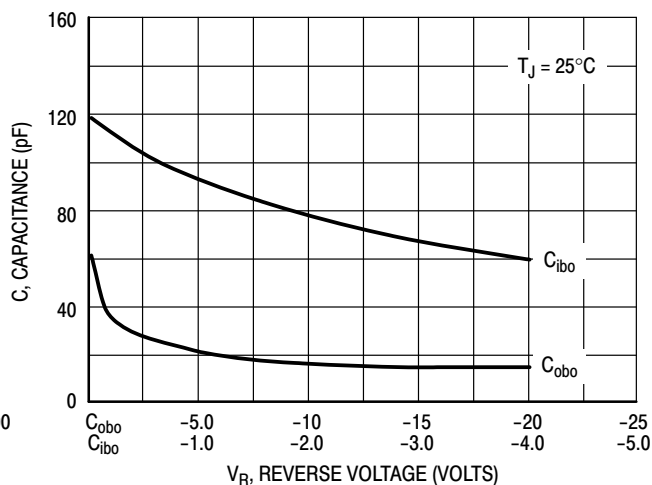

Figure 6. Capacitance

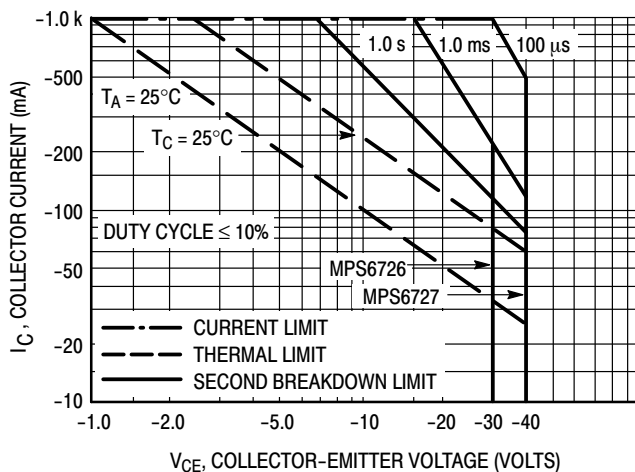
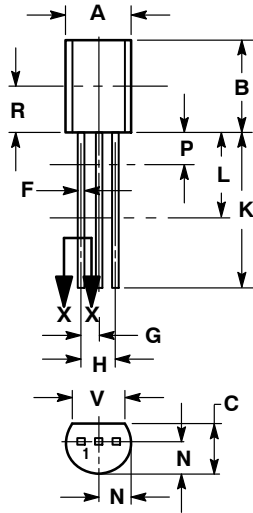

Figure 7. Active Region — Safe Operating Area

MPS6726

PACKAGE DIMENSIONS

TO-92 (TO-226) 1 WATT
CASE 29-10
ISSUE O



STRAIGHT LEAD
BULK PACK

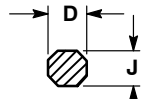

SECTION X-X

NOTES:

1. DIMENSIONING AND TOLERANCING PER ANSI Y14.5M, 1994.
2. CONTROLLING DIMENSION: INCHES.
3. CONTOUR OF PACKAGE BEYOND DIMENSION R IS UNCONTROLLED.
4. DIMENSION F APPLIES BETWEEN DIMENSIONS P AND L. DIMENSIONS D AND J APPLY BETWEEN DIMENSIONS L AND K MINIMUM. THE LEAD DIMENSIONS ARE UNCONTROLLED IN DIMENSION P AND BEYOND DIMENSION K MINIMUM.

| DIM | INCHES | | MILLIMETERS | |
|-----|--------|-------|-------------|------|
| | MIN | MAX | MIN | MAX |
| A | 0.175 | 0.205 | 4.44 | 5.21 |
| B | 0.290 | 0.310 | 7.37 | 7.87 |
| C | 0.125 | 0.165 | 3.18 | 4.19 |
| D | 0.018 | 0.021 | 0.46 | 0.53 |
| F | 0.016 | 0.019 | 0.41 | 0.48 |
| G | 0.045 | 0.055 | 1.15 | 1.39 |
| H | 0.095 | 0.105 | 2.42 | 2.66 |
| J | 0.018 | 0.024 | 0.46 | 0.61 |
| K | 0.500 | --- | 12.70 | --- |
| L | 0.250 | --- | 6.35 | --- |
| N | 0.080 | 0.105 | 2.04 | 2.66 |
| P | --- | 0.100 | --- | 2.54 |
| R | 0.135 | --- | 3.43 | --- |
| V | 0.135 | --- | 3.43 | --- |

- STYLE 1:
PIN 1. EMITTER
2. BASE
3. COLLECTOR

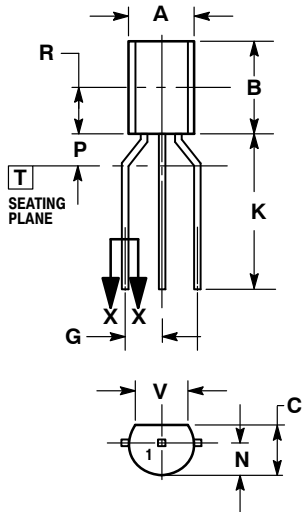

BENT LEAD
TAPE & REEL
AMMO PACK

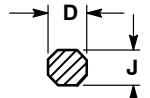

SECTION X-X

NOTES:

1. DIMENSIONING AND TOLERANCING PER ASME Y14.5M, 1994.
2. CONTROLLING DIMENSION: INCHES.
3. CONTOUR OF PACKAGE BEYOND DIMENSION R IS UNCONTROLLED.
4. DIMENSION F APPLIES BETWEEN DIMENSIONS P AND L. DIMENSIONS D AND J APPLY BETWEEN DIMENSIONS L AND K MINIMUM. THE LEAD DIMENSIONS ARE UNCONTROLLED IN DIMENSION P AND BEYOND DIMENSION K MINIMUM.

| DIM | INCHES | | MILLIMETERS | |
|-----|--------|-------|-------------|------|
| | MIN | MAX | MIN | MAX |
| A | 0.175 | 0.205 | 4.44 | 5.21 |
| B | 0.290 | 0.310 | 7.37 | 7.87 |
| C | 0.125 | 0.165 | 3.18 | 4.19 |
| D | 0.018 | 0.021 | 0.46 | 0.53 |
| G | 0.094 | 0.102 | 2.40 | 2.80 |
| J | 0.018 | 0.024 | 0.46 | 0.61 |
| K | 0.500 | --- | 12.70 | --- |
| N | 0.080 | 0.105 | 2.04 | 2.66 |
| P | --- | 0.100 | --- | 2.54 |
| R | 0.135 | --- | 3.43 | --- |
| V | 0.135 | --- | 3.43 | --- |

ON Semiconductor and are registered trademarks of Semiconductor Components Industries, LLC (SCILLC). SCILLC reserves the right to make changes without further notice to any products herein. SCILLC makes no warranty, representation or guarantee regarding the suitability of its products for any particular purpose, nor does SCILLC assume any liability arising out of the application or use of any product or circuit, and specifically disclaims any and all liability, including without limitation special, consequential or incidental damages. "Typical" parameters which may be provided in SCILLC data sheets and/or specifications can and do vary in different applications and actual performance may vary over time. All operating parameters, including "Typicals" must be validated for each customer application by customer's technical experts. SCILLC does not convey any license under its patent rights nor the rights of others. SCILLC products are not designed, intended, or authorized for use as components in systems intended for surgical implant into the body, or other applications intended to support or sustain life, or for any other application in which the failure of the SCILLC product could create a situation where personal injury or death may occur. Should Buyer purchase or use SCILLC products for any such unintended or unauthorized application, Buyer shall indemnify and hold SCILLC and its officers, employees, subsidiaries, affiliates, and distributors harmless against all claims, costs, damages, and expenses, and reasonable attorney fees arising out of, directly or indirectly, any claim of personal injury or death associated with such unintended or unauthorized use, even if such claim alleges that SCILLC was negligent regarding the design or manufacture of the part. SCILLC is an Equal Opportunity/Affirmative Action Employer. This literature is subject to all applicable copyright laws and is not for resale in any manner.

PUBLICATION ORDERING INFORMATION

LITERATURE FULFILLMENT:
Literature Distribution Center for ON Semiconductor
P.O. Box 5163, Denver, Colorado 80217 USA
Phone: 303-675-2175 or 800-344-3860 Toll Free USA/Canada
Fax: 303-675-2176 or 800-344-3867 Toll Free USA/Canada
Email: orderlit@onsemi.com

N. American Technical Support: 800-282-9855 Toll Free
USA/Canada
Europe, Middle East and Africa Technical Support:
Phone: 421 33 790 2910
Japan Customer Focus Center
Phone: 81-3-5773-3850

ON Semiconductor Website: www.onsemi.com
Order Literature: <http://www.onsemi.com/orderlit>
For additional information, please contact your local
Sales Representative

Looking for pricing, stock, or lifecycle information?

Click below to explore more details on WIN SOURCE:

 [View MPS6726G](#) on WIN SOURCE

 [ON Semiconductor](#) Information

Optimize Your Supply Chain with WIN SOURCE Solutions

-  Global Sourcing Solution
-  Obsolete Management
-  Cost Control Management
-  Shortage Management
-  Alternative Solution
-  Excess Inventory Management