



THE DATASHEET OF MRF19085LS



RF Power Field Effect Transistors

N-Channel Enhancement-Mode Lateral MOSFETs

Designed for PCN and PCS base station applications with frequencies from 1900 to 2000 MHz. Suitable for TDMA, CDMA and multicarrier amplifier applications.

- Typical 2-Carrier N-CDMA Performance for $V_{DD} = 26$ Volts, $I_{DQ} = 850$ mA, $P_{out} = 18$ Watts Avg., $f_1 = 1960$ MHz, $f_2 = 1962.5$ MHz IS-95 CDMA (Pilot, Sync, Paging, Traffic Codes 8 Through 13) 1.2288 MHz Channel Bandwidth Carrier. Adjacent Channels Measured over a 30 kHz Bandwidth at $f_1 - 885$ KHz and $f_2 + 885$ kHz. Distortion Products Measured over 1.2288 MHz Bandwidth at $f_1 - 2.5$ MHz and $f_2 + 2.5$ MHz. Peak/Avg. = 9.8 dB @ 0.01% Probability on CCDF.
 - Output Power — 18 Watts Avg.
 - Power Gain — 13.0 dB
 - Efficiency — 23%
 - ACPR — -51 dB
 - IM3 — -36.5 dBc
- Capable of Handling 5:1 VSWR, @ 26 Vdc, 1960 MHz, 90 Watts CW Output Power

Features

- Internally Matched for Ease of Use
- High Gain, High Efficiency and High Linearity
- Integrated ESD Protection
- Designed for Maximum Gain and Insertion Phase Flatness
- Excellent Thermal Stability
- Characterized with Series Equivalent Large-Signal Impedance Parameters
- Available with Low Gold Plating Thickness on Leads. L Suffix Indicates 40 μ " Nominal.
- RoHS Compliant
- In Tape and Reel. R3 Suffix = 250 Units per 56 mm, 13 Inch Reel.

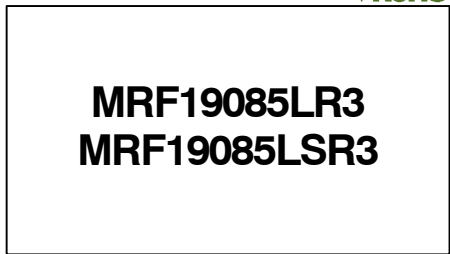

**1930-1990 MHz, 90 W, 26 V
 LATERAL N-CHANNEL
 RF POWER MOSFETs**

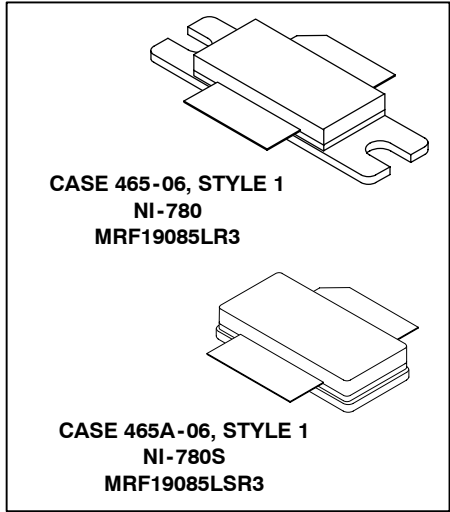

ARCHIVE INFORMATION

ARCHIVE INFORMATION

Table 1. Maximum Ratings

Rating	Symbol	Value	Unit
Drain-Source Voltage	V_{DSS}	-0.5, +65	Vdc
Gate-Source Voltage	V_{GS}	-0.5, +15	Vdc
Total Device Dissipation @ $T_C = 25^\circ\text{C}$ Derate above 25 $^\circ\text{C}$	P_D	273 1.56	W W/ $^\circ\text{C}$
Storage Temperature Range	T_{stg}	- 65 to +150	$^\circ\text{C}$
Case Operating Temperature	T_C	150	$^\circ\text{C}$
Operating Junction Temperature	T_J	200	$^\circ\text{C}$

Table 2. Thermal Characteristics

Characteristic	Symbol	Value (1)	Unit
Thermal Resistance, Junction to Case	$R_{\theta JC}$	0.79	$^\circ\text{C}/\text{W}$

Table 3. ESD Protection Characteristics

Test Conditions	Class
Human Body Model	1 (Minimum)
Machine Model	M3 (Minimum)

1. Refer to AN1955, *Thermal Measurement Methodology of RF Power Amplifiers*. Go to <http://www.freescale.com/rf>. Select Documentation/Application Notes - AN1955.

Table 4. Electrical Characteristics ($T_C = 25^\circ\text{C}$ unless otherwise noted)

Characteristic	Symbol	Min	Typ	Max	Unit
Off Characteristics					
Drain-Source Breakdown Voltage ($V_{GS} = 0\text{ Vdc}$, $I_D = 100\ \mu\text{Adc}$)	$V_{(BR)DSS}$	65	—	—	Vdc
Zero Gate Voltage Drain Current ($V_{DS} = 26\text{ Vdc}$, $V_{GS} = 0\text{ Vdc}$)	I_{DSS}	—	—	10	μAdc
Gate-Source Leakage Current ($V_{GS} = 5\text{ Vdc}$, $V_{DS} = 0\text{ Vdc}$)	I_{GSS}	—	—	1	μAdc
On Characteristics (DC)					
Gate Threshold Voltage ($V_{DS} = 10\text{ Vdc}$, $I_D = 200\ \mu\text{Adc}$)	$V_{GS(th)}$	2	—	4	Vdc
Gate Quiescent Voltage ($V_{DS} = 26\text{ Vdc}$, $I_D = 850\text{ mAdc}$)	$V_{GS(Q)}$	2.5	3.5	4.5	Vdc
Drain-Source On-Voltage ($V_{GS} = 10\text{ Vdc}$, $I_D = 2\text{ Adc}$)	$V_{DS(on)}$	—	0.18	0.210	Vdc
Forward Transconductance ($V_{DS} = 10\text{ Vdc}$, $I_D = 2\text{ Adc}$)	g_{fs}	—	6	—	S
Dynamic Characteristics					
Reverse Transfer Capacitance (1) ($V_{DS} = 26\text{ Vdc}$, $V_{GS} = 0$, $f = 1.0\text{ MHz}$)	C_{rss}	—	3.6	—	pF
Functional Tests (In Freescale Test Fixture, 50 ohm system) 2-Carrier N-CDMA, 1.2288 MHz Channel Bandwidth Carriers. Peak/Avg. = 9.8 dB @ 0.01% Probability on CCDF.					
Common-Source Amplifier Power Gain ($V_{DD} = 26\text{ Vdc}$, $P_{out} = 18\text{ W Avg.}$, $I_{DQ} = 850\text{ mA}$, $f_1 = 1930\text{ MHz}$, $f_2 = 1932.5\text{ MHz}$ and $f_1 = 1987.5\text{ MHz}$, $f_2 = 1990\text{ MHz}$)	G_{ps}	12	13	—	dB
Drain Efficiency ($V_{DD} = 26\text{ Vdc}$, $P_{out} = 18\text{ W Avg.}$, $I_{DQ} = 850\text{ mA}$, $f_1 = 1930\text{ MHz}$, $f_2 = 1932.5\text{ MHz}$ and $f_1 = 1987.5\text{ MHz}$, $f_2 = 1990\text{ MHz}$)	η	21	23	—	%
3rd Order Intermodulation Distortion ($V_{DD} = 26\text{ Vdc}$, $P_{out} = 18\text{ W Avg.}$, $I_{DQ} = 850\text{ mA}$, $f_1 = 1930\text{ MHz}$, $f_2 = 1932.5\text{ MHz}$ and $f_1 = 1987.5\text{ MHz}$, $f_2 = 1990\text{ MHz}$); IM3 measured over 1.2288 MHz bandwidth @ $f_1 - 2.5\text{ MHz}$ and $f_2 = +2.5\text{ MHz}$)	IMD	—	-36.5	-35	dBc
Adjacent Channel Power Ratio ($V_{DD} = 26\text{ Vdc}$, $P_{out} = 18\text{ W Avg.}$, $I_{DQ} = 850\text{ mA}$, $f_1 = 1930\text{ MHz}$, $f_2 = 1932.5\text{ MHz}$ and $f_1 = 1987.5\text{ MHz}$, $f_2 = 1990\text{ MHz}$); ACPR measured over 30 kHz bandwidth @ $f_1 - 885\text{ MHz}$ and $f_2 = +885\text{ MHz}$)	ACPR	—	-51	-48	dBc
Input Return Loss ($V_{DD} = 26\text{ Vdc}$, $P_{out} = 18\text{ W Avg.}$, $I_{DQ} = 850\text{ mA}$, $f_1 = 1930\text{ MHz}$, $f_2 = 1932.5\text{ MHz}$ and $f_1 = 1987.5\text{ MHz}$, $f_2 = 1990\text{ MHz}$)	IRL	—	-12	-9	dB

1. Part is internally matched both on input and output.

(continued)

Table 4. Electrical Characteristics ($T_C = 25^\circ\text{C}$ unless otherwise noted) (continued)

Characteristic	Symbol	Min	Typ	Max	Unit
Functional Tests (In Freescale Test Fixture)					
Two-Tone Common-Source Amplifier Power Gain ($V_{DD} = 26\text{ Vdc}$, $P_{out} = 90\text{ W PEP}$, $I_{DQ} = 850\text{ mA}$, $f = 1930\text{ MHz}$ and 1990 MHz , Tone Spacing = 100 kHz)	G_{ps}	—	13	—	dB
Two-Tone Drain Efficiency ($V_{DD} = 26\text{ Vdc}$, $P_{out} = 90\text{ W PEP}$, $I_{DQ} = 850\text{ mA}$, $f = 1930\text{ MHz}$ and 1990 MHz , Tone Spacing = 100 kHz)	η	—	36	—	%
3rd Order Intermodulation Distortion ($V_{DD} = 26\text{ Vdc}$, $P_{out} = 90\text{ W PEP}$, $I_{DQ} = 850\text{ mA}$, $f = 1930\text{ MHz}$ and 1990 MHz , Tone Spacing = 100 kHz)	IMD	—	-31	—	dBc
Input Return Loss ($V_{DD} = 26\text{ Vdc}$, $P_{out} = 90\text{ W PEP}$, $I_{DQ} = 850\text{ mA}$, $f = 1930\text{ MHz}$ and 1990 MHz , Tone Spacing = 100 kHz)	IRL	—	-12	—	dB
P_{out} , 1 dB Compression Point ($V_{DD} = 26\text{ Vdc}$, $I_{DQ} = 850\text{ mA}$, $f = 1990\text{ MHz}$)	P1dB	—	90	—	W

ARCHIVE INFORMATION

ARCHIVE INFORMATION

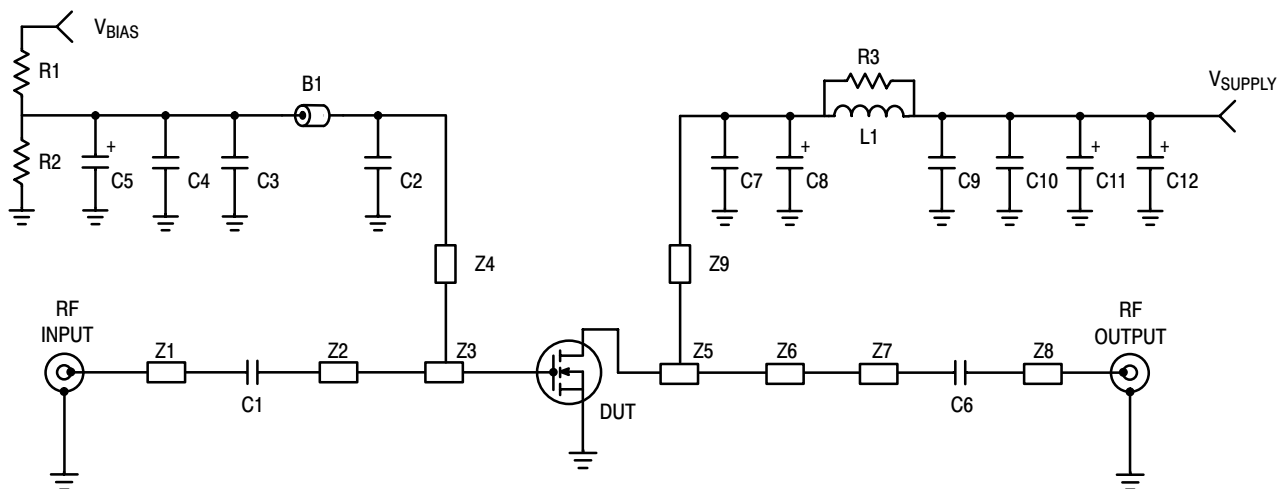
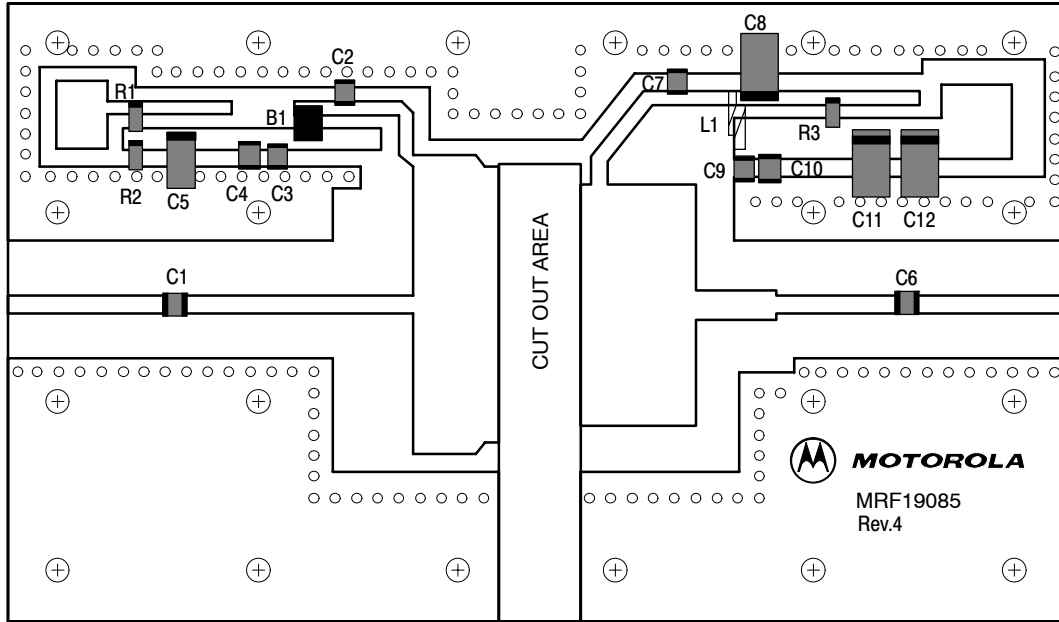

Figure 1. 1930 - 1990 MHz 2-Carrier N-CDMA Test Circuit Schematic

Table 5. 1930 - 1990 MHz 2-Carrier N-CDMA Test Circuit Component Designations and Values

Part	Description	Part Number	Manufacturer
B1	Short Ferrite Bead	2743019447	Fair Rite
C1	51 pF Chip Capacitor	100B510JCA500X	ATC
C2, C7	5.1 pF Chip Capacitors	100B5R1JCA500X	ATC
C3, C9	1000 pF Chip Capacitors	100B102JCA500X	ATC
C4, C10	0.1 μ F Chip Capacitors	CDR33BX104AKWS	Kemet
C5	0.1 μ F Tantalum Surface Mount Capacitor	T491C105M050	Kemet
C6	10 pF Chip Capacitor	100B100JCA500X	ATC
C8	10 μ F Tantalum Surface Mount Capacitor	T495X106K035AS4394	Kemet
C11, C12	22 μ F Tantalum Surface Mount Capacitors	T491X226K035AS4394	Kemet
L1	1 Turn, 20 AWG, 0.100" ID		
N1, N2	Type N Flange Mounts	3052-1648-10	Omni Spectra
R1	1.0 k Ω , 1/8 W Chip Resistor		
R2	220 k Ω , 1/8 W Chip Resistor		
R3	10 Ω , 1/8 W Chip Resistor		
Z1	Microstrip	0.750" x 0.0840"	
Z2	Microstrip	1.090" x 0.0840"	
Z3	Microstrip	0.400" x 1.400"	
Z4	Microstrip	0.520" x 0.050"	
Z5	Microstrip	0.540" x 1.133"	
Z6	Microstrip	0.400" x 0.140"	
Z7	Microstrip	0.555" x 0.0840"	
Z8	Microstrip	0.720" x 0.0840"	
Z9	Microstrip	0.560" x 0.070"	
Board	0.030" Glass Teflon [®]	GX-0300-55-22, $\epsilon_r = 2.55$	Keene
PCB	Etched Circuit Boards	MRF19085 Rev. 4	CMR



Freescall has begun the transition of marking Printed Circuit Boards (PCBs) with the Freescall Semiconductor signature/logo. PCBs may have either Motorola or Freescall markings during the transition period. These changes will have no impact on form, fit or function of the current product.

Figure 2. 1930 - 1990 MHz 2-Carrier N-CDMA Test Circuit Component Layout

TYPICAL CHARACTERISTICS

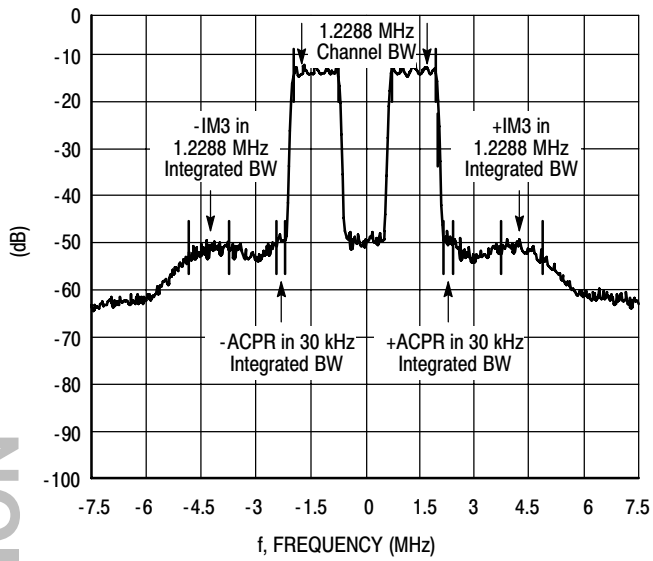

Figure 3. 2-Carrier N-CDMA Spectrum

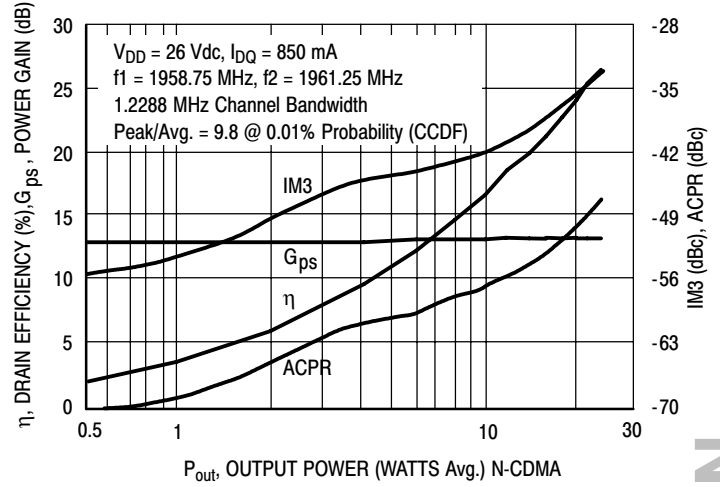

Figure 4. 2-Carrier N-CDMA ACPR, IM3, Power Gain and Drain Efficiency versus Output Power

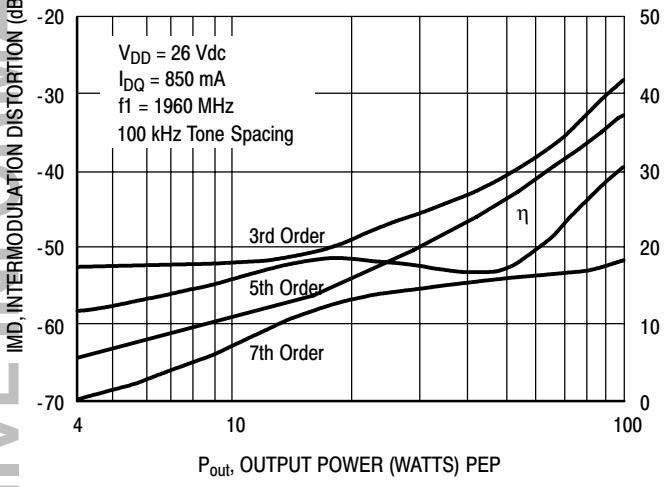

Figure 5. Intermodulation Distortion Products versus Output Power

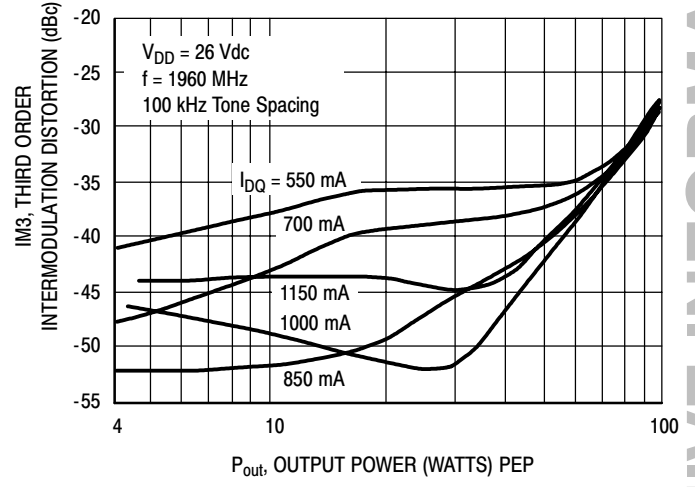

Figure 6. Third Order Intermodulation Distortion versus Output Power and IDQ

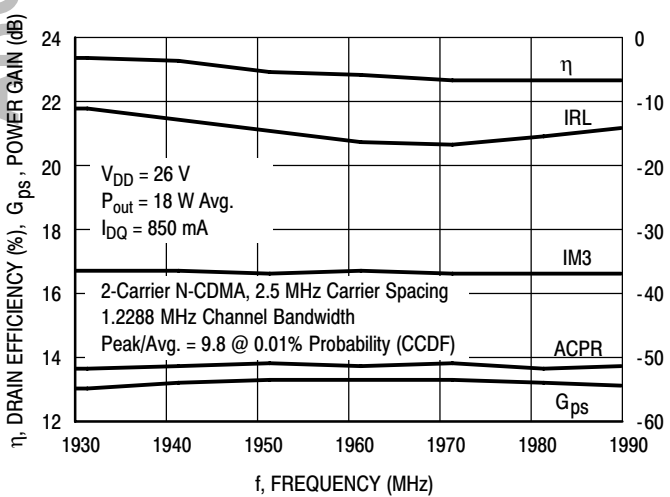

Figure 7. 2-Carrier N-CDMA Broadband Performance

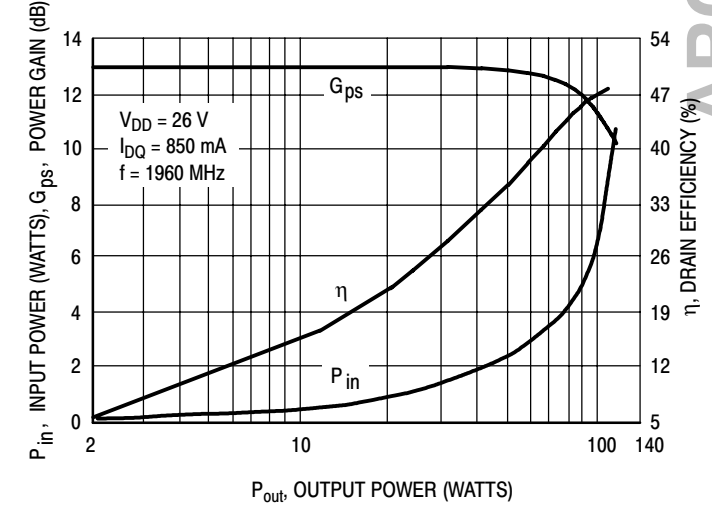

Figure 8. CW Performance

TYPICAL CHARACTERISTICS

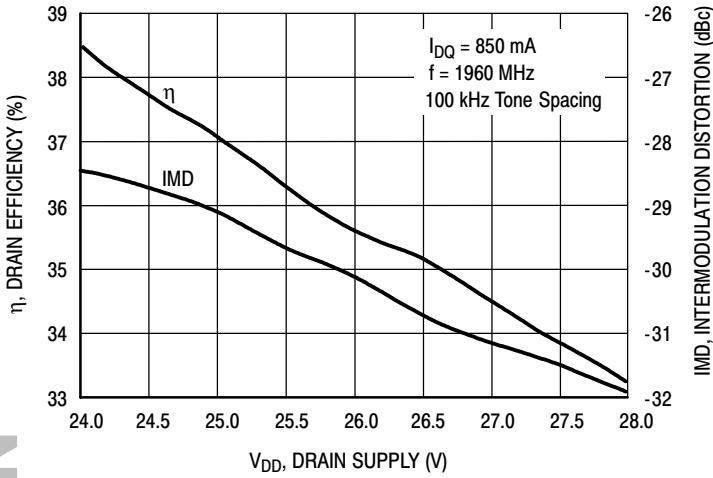

Figure 9. Two-Tone Intermodulation Distortion and Drain Efficiency versus Drain Supply

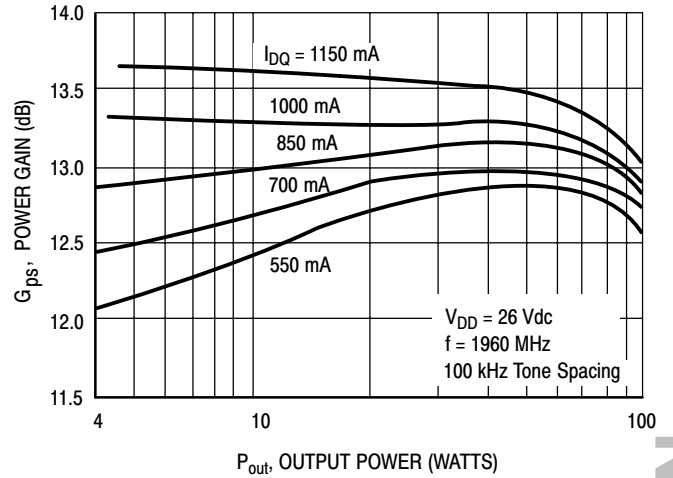

Figure 10. Two-Tone Power Gain versus Output Power

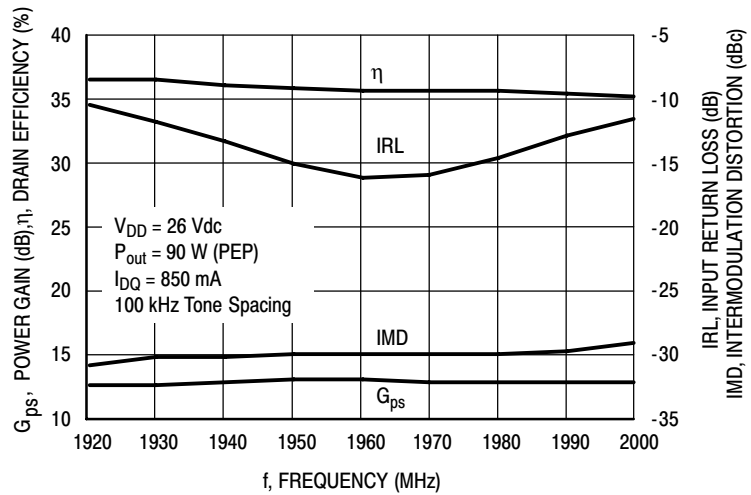
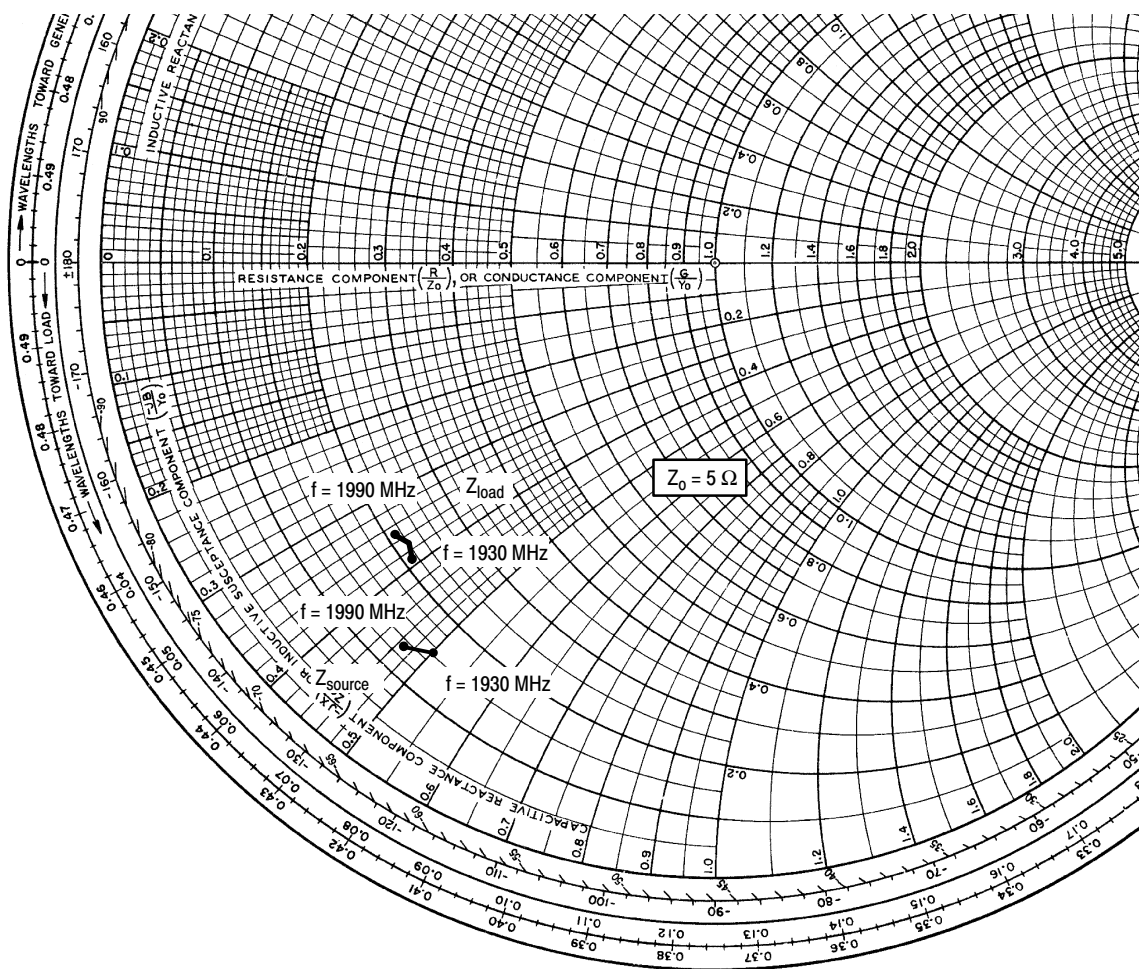

Figure 11. Two-Tone Broadband Performance

ARCHIVE INFORMATION

ARCHIVE INFORMATION



$V_{DD} = 26\text{ V}$, $I_{DQ} = 850\text{ mA}$, $P_{out} = 18\text{ W Avg.}$

f MHz	Z_{source} Ω	Z_{load} Ω
1930	$0.75 - j2.50$	$1.05 - j1.95$
1960	$0.70 - j2.40$	$1.10 - j1.85$
1990	$0.65 - j2.35$	$1.05 - j1.75$

Z_{source} = Test circuit impedance as measured from gate to ground.

Z_{load} = Test circuit impedance as measured from drain to ground.

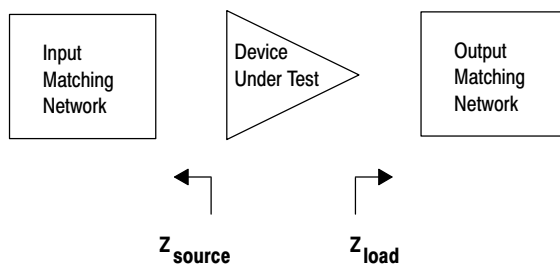

Figure 12. Series Equivalent Source and Load Impedance

ARCHIVE INFORMATION

ARCHIVE INFORMATION

ARCHIVE INFORMATION

ARCHIVE INFORMATION

PACKAGE DIMENSIONS

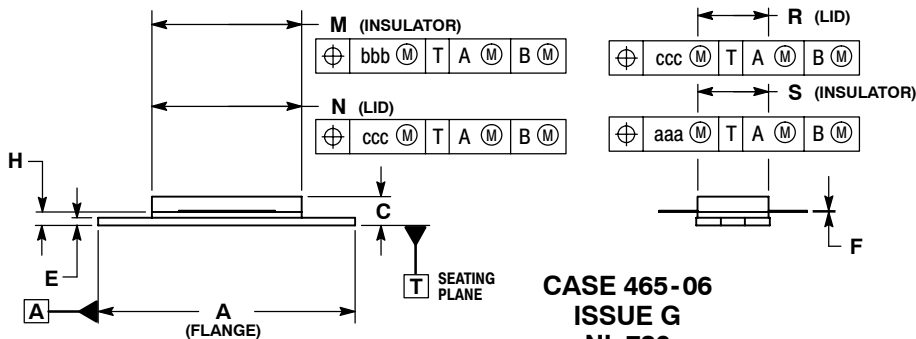
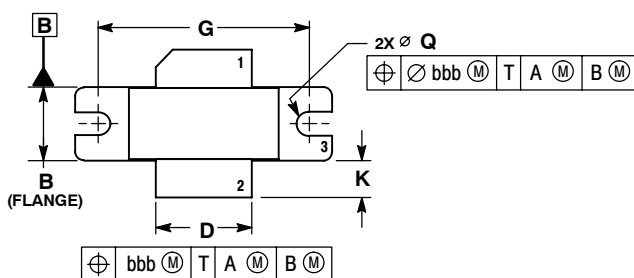

**CASE 465-06
ISSUE G
NI-780
MRF19085LR3**

- NOTES:
1. DIMENSIONING AND TOLERANCING PER ANSI Y14.5M-1994.
 2. CONTROLLING DIMENSION: INCH.
 3. DELETED
 4. DIMENSION H IS MEASURED 0.030 (0.762) AWAY FROM PACKAGE BODY.

DIM	INCHES		MILLIMETERS	
	MIN	MAX	MIN	MAX
A	1.335	1.345	33.91	34.16
B	0.380	0.390	9.65	9.91
C	0.125	0.170	3.18	4.32
D	0.495	0.505	12.57	12.83
E	0.035	0.045	0.89	1.14
F	0.003	0.006	0.08	0.15
G	1.100 BSC		27.94 BSC	
H	0.057	0.067	1.45	1.70
K	0.170	0.210	4.32	5.33
M	0.774	0.786	19.66	19.96
N	0.772	0.788	19.60	20.00
Q	Ø.118	Ø.138	Ø3.00	Ø3.51
R	0.365	0.375	9.27	9.53
S	0.365	0.375	9.27	9.52
aaa	0.005 REF		0.127 REF	
bbb	0.010 REF		0.254 REF	
ccc	0.015 REF		0.381 REF	

- STYLE 1:
PIN 1. DRAIN
2. GATE
3. SOURCE

ARCHIVE INFORMATION

ARCHIVE INFORMATION

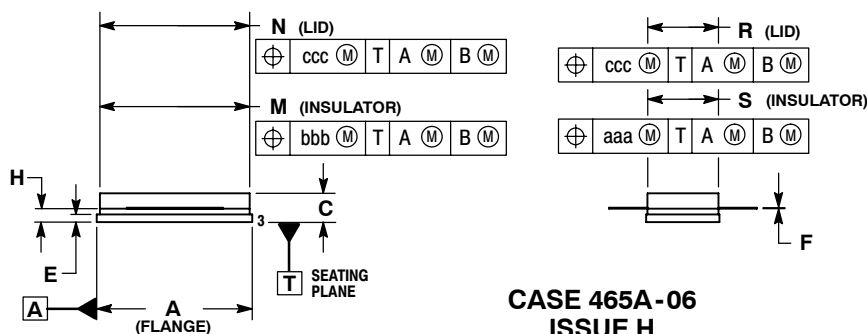
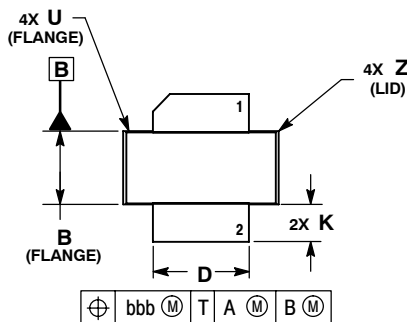

**CASE 465A-06
ISSUE H
NI-780S
MRF19085LSR3**

- NOTES:
1. DIMENSIONING AND TOLERANCING PER ANSI Y14.5M-1994.
 2. CONTROLLING DIMENSION: INCH.
 3. DELETED
 4. DIMENSION H IS MEASURED 0.030 (0.762) AWAY FROM PACKAGE BODY.

DIM	INCHES		MILLIMETERS	
	MIN	MAX	MIN	MAX
A	0.805	0.815	20.45	20.70
B	0.380	0.390	9.65	9.91
C	0.125	0.170	3.18	4.32
D	0.495	0.505	12.57	12.83
E	0.035	0.045	0.89	1.14
F	0.003	0.006	0.08	0.15
H	0.057	0.067	1.45	1.70
K	0.170	0.210	4.32	5.33
M	0.774	0.786	19.61	20.02
N	0.772	0.788	19.61	20.02
R	0.365	0.375	9.27	9.53
S	0.365	0.375	9.27	9.52
U	---	0.040	---	1.02
Z	---	0.030	---	0.76
aaa	0.005 REF		0.127 REF	
bbb	0.010 REF		0.254 REF	
ccc	0.015 REF		0.381 REF	

- STYLE 1:
PIN 1. DRAIN
2. GATE
5. SOURCE

How to Reach Us:

Home Page:
www.freescale.com

E-mail:
support@freescale.com

USA/Europe or Locations Not Listed:
Freescale Semiconductor
Technical Information Center, CH370
1300 N. Alma School Road
Chandler, Arizona 85224
+1-800-521-6274 or +1-480-768-2130
support@freescale.com

Europe, Middle East, and Africa:
Freescale Halbleiter Deutschland GmbH
Technical Information Center
Schatzbogen 7
81829 Muenchen, Germany
+44 1296 380 456 (English)
+46 8 52200080 (English)
+49 89 92103 559 (German)
+33 1 69 35 48 48 (French)
support@freescale.com

Japan:
Freescale Semiconductor Japan Ltd.
Headquarters
ARCO Tower 15F
1-8-1, Shimo-Meguro, Meguro-ku,
Tokyo 153-0064
Japan
0120 191014 or +81 3 5437 9125
support.japan@freescale.com

Asia/Pacific:
Freescale Semiconductor Hong Kong Ltd.
Technical Information Center
2 Dai King Street
Tai Po Industrial Estate
Tai Po, N.T., Hong Kong
+800 2666 8080
support.asia@freescale.com

For Literature Requests Only:

Freescale Semiconductor Literature Distribution Center
P.O. Box 5405
Denver, Colorado 80217
1-800-441-2447 or 303-675-2140
Fax: 303-675-2150
LDCForFreescaleSemiconductor@hibbertgroup.com

Information in this document is provided solely to enable system and software implementers to use Freescale Semiconductor products. There are no express or implied copyright licenses granted hereunder to design or fabricate any integrated circuits or integrated circuits based on the information in this document.

Freescale Semiconductor reserves the right to make changes without further notice to any products herein. Freescale Semiconductor makes no warranty, representation or guarantee regarding the suitability of its products for any particular purpose, nor does Freescale Semiconductor assume any liability arising out of the application or use of any product or circuit, and specifically disclaims any and all liability, including without limitation consequential or incidental damages. "Typical" parameters that may be provided in Freescale Semiconductor data sheets and/or specifications can and do vary in different applications and actual performance may vary over time. All operating parameters, including "Typicals", must be validated for each customer application by customer's technical experts. Freescale Semiconductor does not convey any license under its patent rights nor the rights of others. Freescale Semiconductor products are not designed, intended, or authorized for use as components in systems intended for surgical implant into the body, or other applications intended to support or sustain life, or for any other application in which the failure of the Freescale Semiconductor product could create a situation where personal injury or death may occur. Should Buyer purchase or use Freescale Semiconductor products for any such unintended or unauthorized application, Buyer shall indemnify and hold Freescale Semiconductor and its officers, employees, subsidiaries, affiliates, and distributors harmless against all claims, costs, damages, and expenses, and reasonable attorney fees arising out of, directly or indirectly, any claim of personal injury or death associated with such unintended or unauthorized use, even if such claim alleges that Freescale Semiconductor was negligent regarding the design or manufacture of the part.

Freescale™ and the Freescale logo are trademarks of Freescale Semiconductor, Inc. All other product or service names are the property of their respective owners.
© Freescale Semiconductor, Inc. 2006, 2008. All rights reserved.

Looking for pricing, stock, or lifecycle information?

Click below to explore more details on WIN SOURCE:

- ⊖ [View MRF19085LS on WIN SOURCE](#)
- ⊖ [Freescale Semiconductor - NXP Information](#)

Optimize Your Supply Chain with WIN SOURCE Solutions

- ✓ Global Sourcing Solution
- ✓ Obsolete Management
- ✓ Cost Control Management
- ✓ Shortage Management
- ✓ Alternative Solution
- ✓ Excess Inventory Management