



**THE DATASHEET OF  
MRF5S21100HR5**



# RF Power Field Effect Transistors

## N-Channel Enhancement-Mode Lateral MOSFETs

Designed for W-CDMA base station applications with frequencies from 2110 to 2170 MHz. Suitable for TDMA, CDMA and multicarrier amplifier applications. To be used in Class AB for PCN-PCS/cellular radio and WLL applications.

- Typical 2-carrier W-CDMA Performance:  $V_{DD} = 28$  Volts,  $I_{DQ} = 1050$  mA,  $P_{out} = 23$  Watts Avg.,  $f = 2167.5$  MHz, Channel Bandwidth = 3.84 MHz, PAR = 8.5 dB @ 0.01% Probability on CCDF.  
 Power Gain — 13.5 dB  
 Drain Efficiency — 26%  
 IM3 @ 10 MHz Offset — -37 dBc in 3.84 MHz Channel Bandwidth  
 ACPR @ 5 MHz Offset — -40 dBc in 3.84 MHz Channel Bandwidth
- Capable of Handling 10:1 VSWR, @ 28 Vdc, 2140 MHz, 100 Watts CW Output Power

### Features

- Characterized with Series Equivalent Large-Signal Impedance Parameters
- Internally Matched for Ease of Use
- Qualified Up to a Maximum of 32  $V_{DD}$  Operation
- Integrated ESD Protection
- Lower Thermal Resistance Package
- Low Gold Plating Thickness on Leads, 40 $\mu$ ” Nominal.
- RoHS Compliant
- In Tape and Reel. R3 Suffix = 250 Units per 56 mm, 13 inch Reel.

**MRF5S21100HR3**  
**MRF5S21100HSR3**

**2110-2170 MHz, 23 W AVG., 28 V**  
**2 x W-CDMA**  
**LATERAL N-CHANNEL**  
**RF POWER MOSFETs**

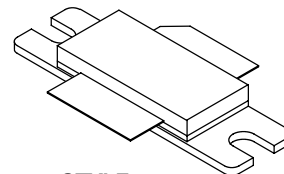

**CASE 465-06, STYLE 1**  
**NI-780**  
**MRF5S21100HR3**

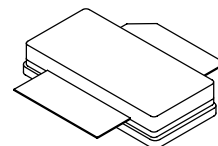

**CASE 465A-06, STYLE 1**  
**NI-780S**  
**MRF5S21100HSR3**

ARCHIVE INFORMATION

ARCHIVE INFORMATION

**Table 1. Maximum Ratings**

Rating	Symbol	Value	Unit
Drain-Source Voltage	$V_{DSS}$	-0.5, +65	Vdc
Gate-Source Voltage	$V_{GS}$	-0.5, +15	Vdc
Total Device Dissipation @ $T_C = 25^\circ\text{C}$ Derate above 25 $^\circ\text{C}$	$P_D$	273 1.56	W W/ $^\circ\text{C}$
Storage Temperature Range	$T_{stg}$	- 65 to +150	$^\circ\text{C}$
Case Operating Temperature	$T_C$	150	$^\circ\text{C}$
Operating Junction Temperature	$T_J$	200	$^\circ\text{C}$

**Table 2. Thermal Characteristics**

Characteristic	Symbol	Value (1,2)	Unit
Thermal Resistance, Junction to Case Case Temperature 80 $^\circ\text{C}$ , 100 W CW Case Temperature 78 $^\circ\text{C}$ , 23 W CW	$R_{\theta JC}$	0.57 0.64	$^\circ\text{C}/\text{W}$

1. MTTF calculator available at <http://www.freescale.com/rf>. Select Software & Tools/Development Tools/Calculators to access MTTF calculators by product.
2. Refer to AN1955, *Thermal Measurement Methodology of RF Power Amplifiers*. Go to <http://www.freescale.com/rf>. Select Documentation/Application Notes - AN1955.

**Table 3. ESD Protection Characteristics**

Test Conditions	Class
Human Body Model	2 (Minimum)
Machine Model	M3 (Minimum)
Charge Device Model	C7 (Minimum)

**Table 4. Electrical Characteristics** ( $T_A = 25^\circ\text{C}$  unless otherwise noted)

Characteristic	Symbol	Min	Typ	Max	Unit
<b>Off Characteristics</b>					
Zero Gate Voltage Drain Leakage Current ( $V_{DS} = 65\text{ Vdc}$ , $V_{GS} = 0\text{ Vdc}$ )	$I_{DSS}$	—	—	10	$\mu\text{Adc}$
Zero Gate Voltage Drain Leakage Current ( $V_{DS} = 28\text{ Vdc}$ , $V_{GS} = 0\text{ Vdc}$ )	$I_{DSS}$	—	—	1	$\mu\text{Adc}$
Gate-Source Leakage Current ( $V_{GS} = 5\text{ Vdc}$ , $V_{DS} = 0\text{ Vdc}$ )	$I_{GSS}$	—	—	0.5	$\mu\text{Adc}$

**On Characteristics (DC)**

Gate Threshold Voltage ( $V_{DS} = 10\text{ Vdc}$ , $I_D = 250\ \mu\text{Adc}$ )	$V_{GS(th)}$	2.5	2.8	3.5	Vdc
Gate Quiescent Voltage ( $V_{DS} = 28\text{ Vdc}$ , $I_D = 1050\ \text{mAdc}$ )	$V_{GS(Q)}$	—	3.8	—	Vdc
Drain-Source On-Voltage ( $V_{GS} = 10\text{ Vdc}$ , $I_D = 2.5\ \text{Adc}$ )	$V_{DS(on)}$	—	0.24	0.3	Vdc
Forward Transconductance ( $V_{DS} = 10\text{ Vdc}$ , $I_D = 2.5\ \text{Adc}$ )	$g_{fs}$	—	6	—	S

**Dynamic Characteristics (1)**

Reverse Transfer Capacitance ( $V_{DS} = 28\text{ Vdc} \pm 30\ \text{mV(rms)ac}$ @ 1 MHz, $V_{GS} = 0\text{ Vdc}$ )	$C_{rss}$	—	2.14	—	pF
--	-----------	---	------	---	----

**Functional Tests** (In Freescale Test Fixture, 50 ohm system)  $V_{DD} = 28\text{ Vdc}$ ,  $I_{DQ} = 1050\ \text{mA}$ ,  $P_{out} = 23\ \text{W Avg.}$ ,  $f_1 = 2157.5\ \text{MHz}$ ,  $f_2 = 2167.5\ \text{MHz}$ , 2-carrier W-CDMA, 3.84 MHz Channel Bandwidth Carriers. ACPR measured in 3.84 MHz Channel Bandwidth @  $\pm 5\ \text{MHz}$  Offset. IM3 measured in 3.84 MHz Bandwidth @  $\pm 10\ \text{MHz}$  Offset. PAR = 8.5 dB @ 0.01% Probability on CCDF.

Power Gain	$G_{ps}$	12.5	13.5	—	dB
Drain Efficiency	$\eta_D$	24	26	—	%
Intermodulation Distortion	IM3	—	-37	-35	dBc
Adjacent Channel Power Ratio	ACPR	—	-40	-38	dBc
Input Return Loss	IRL	—	-16	-9	dB

1. Part is internally matched both on input and output.

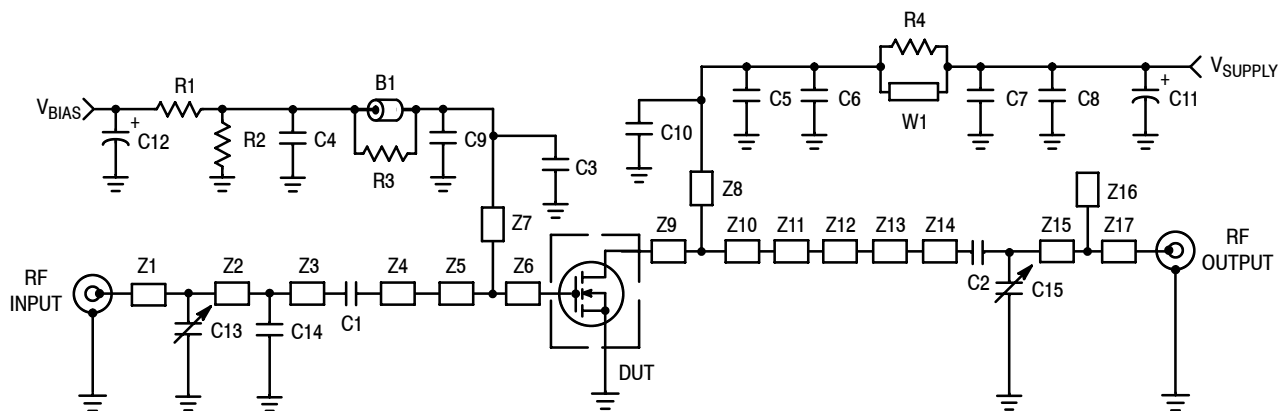

Z1	0.674" x 0.080" Microstrip	Z10	0.368" x 1.136" Microstrip
Z2	0.421" x 0.080" Microstrip	Z11	0.151" x 0.393" Microstrip
Z3	0.140" x 0.080" Microstrip	Z12	0.280" x 0.220" Microstrip
Z4	1.031" x 0.080" Microstrip	Z13	0.481" x 0.142" Microstrip
Z5	0.380" x 0.643" Microstrip	Z14	0.138" x 0.080" Microstrip
Z6	0.080" x 0.643" Microstrip	Z15	0.344" x 0.080" Microstrip
Z7	0.927" x 0.048" Microstrip	Z16	0.147" x 0.099" Microstrip
Z8	0.620" x 0.048" Microstrip	Z17	0.859" x 0.080" Microstrip
Z9	0.079" x 1.136" Microstrip	PCB	Arlon GX-0300-SS-22, 0.030", $\epsilon_r = 2.55$

Figure 1. MRF5S21100HR3(SR3) Test Circuit Schematic

Table 5. MRF5S21100HR3(SR3) Test Circuit Component Designations and Values

Part	Description	Part Number	Manufacturer
B1	Short RF Bead	2743019447	Fair-Rite
C1, C2	8.2 pF Chip Capacitors	ATC100B8R2CT500XT	ATC
C3	5.6 pF Chip Capacitor	ATC100B5R6CT500XT	ATC
C4	0.1 $\mu$ F Chip Capacitor	C1210C104J5RAC	Kemet
C5, C7	7.5 pF Chip Capacitors	ATC100B7R5JT500XT	ATC
C6	1.2 pF Chip Capacitor	ATC100B1R2BT500XT	ATC
C8	1K pF Chip Capacitor	ATC100B102JT500XT	ATC
C9, C10	0.56 $\mu$ F Chip Capacitors	C1825C564J5RAC	Kemet
C11	470 $\mu$ F, 63 V Electrolytic Capacitor	EKME630ELL471MK25S	Multicomp
C12	100 $\mu$ F, 50 V Electrolytic Capacitor	MCHT101M1HB-1017-RH	Multicomp
C13	0.6-4.5 pF Gigatrim Variable Capacitor	27271SL	Johanson
C14	2.7 pF Chip Capacitor	ATC100B2R7CT500XT	ATC
C15	0.4-2.5 pF Gigatrim Variable Capacitor	27271SL	Johanson
R1	1 k $\Omega$ , 1/4 W Chip Resistor	CRCW12061001FKEA	Vishay
R2	560 k $\Omega$ , 1/4 W Chip Resistor	CRCW12065600FKEA	Vishay
R3, R4	12 $\Omega$ , 1/4 W Chip Resistors	CRCW120612R0FKEA	Vishay

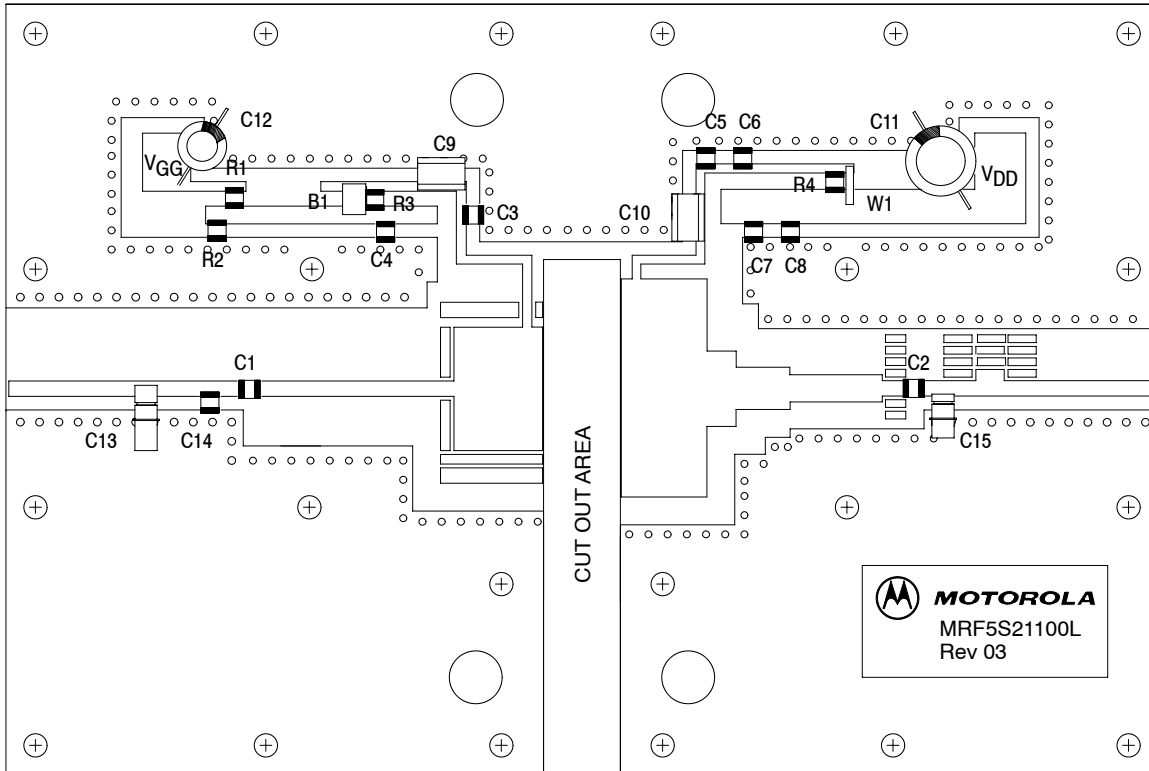

Freescall has begun the transition of marking Printed Circuit Boards (PCBs) with the Freescall Semiconductor signature/logo. PCBs may have either Motorola or Freescall markings during the transition period. These changes will have no impact on form, fit or function of the current product.

**Figure 2. MRF5S21100HR3(SR3) Test Circuit Component Layout**

### TYPICAL CHARACTERISTICS

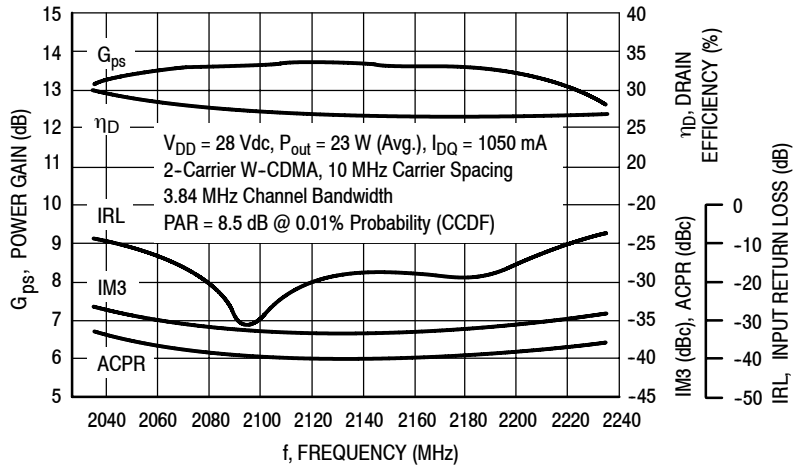

Figure 3. 2-Carrier W-CDMA Broadband Performance

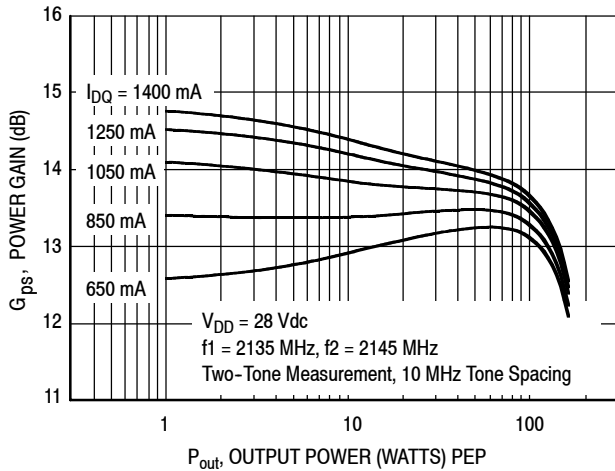

Figure 4. Two-Tone Power Gain versus Output Power

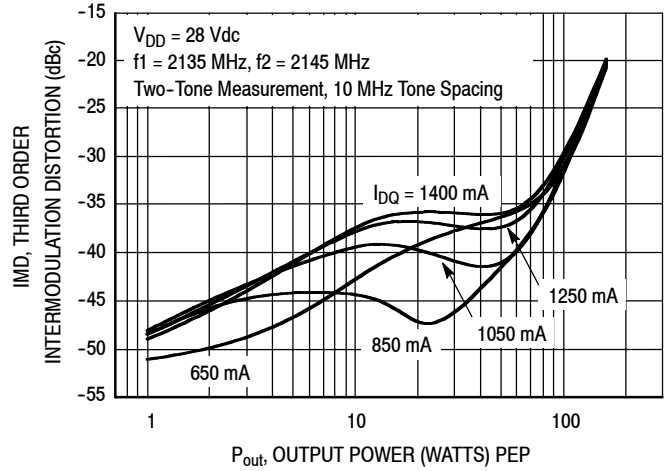

Figure 5. Third Order Intermodulation Distortion versus Output Power

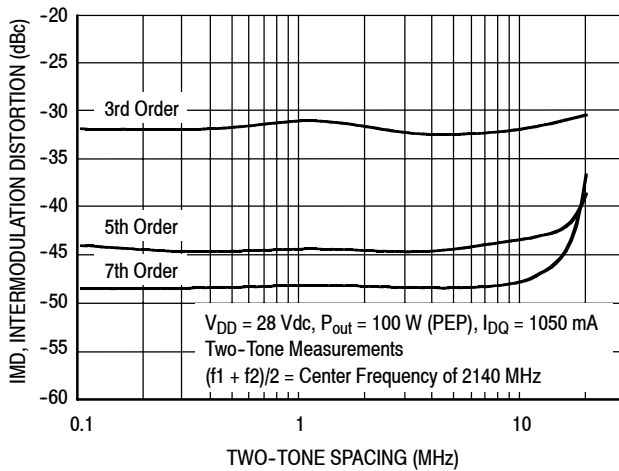

Figure 6. Intermodulation Distortion Products versus Tone Spacing

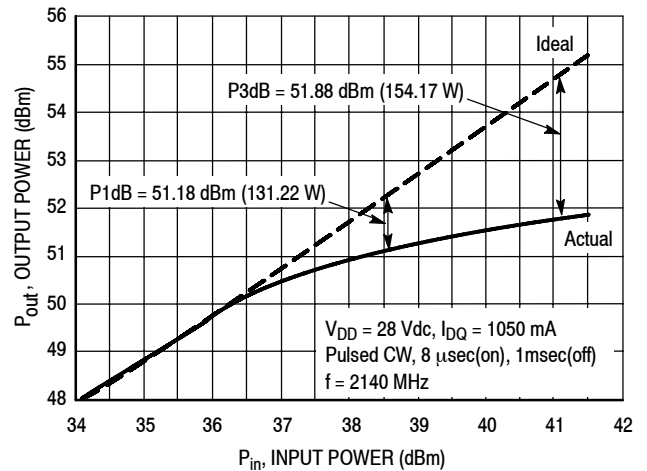
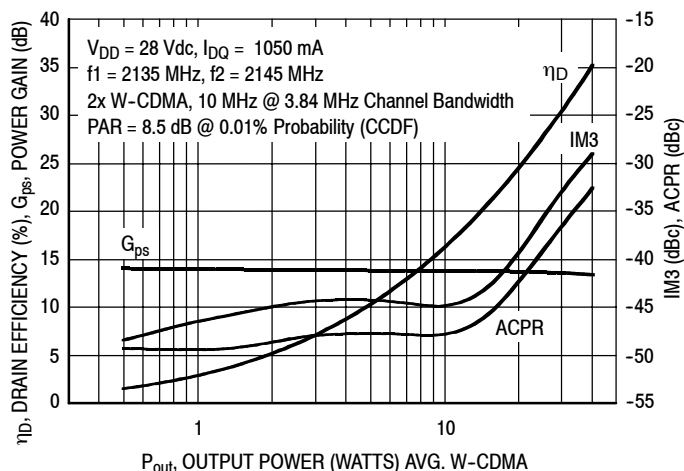

Figure 7. Pulse CW Output Power versus Input Power

ARCHIVE INFORMATION

ARCHIVE INFORMATION

### TYPICAL CHARACTERISTICS



**Figure 8. 2-Carrier W-CDMA ACPR, IM3, Power Gain and Drain Efficiency versus Output Power**

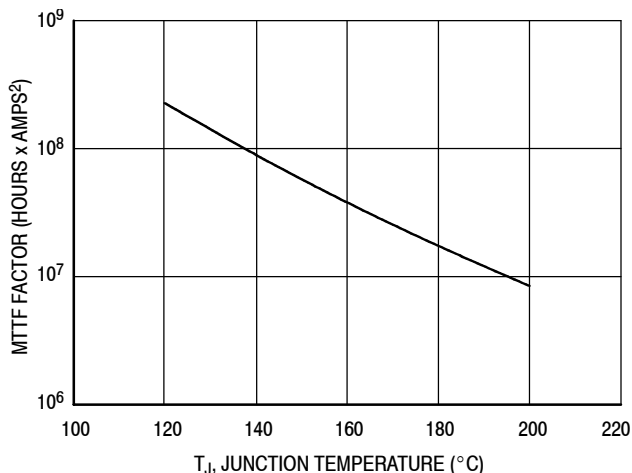

This above graph displays calculated MTTF in hours x ampere<sup>2</sup> drain current. Life tests at elevated temperatures have correlated to better than  $\pm 10\%$  of the theoretical prediction for metal failure. Divide MTTF factor by  $I_D^2$  for MTTF in a particular application.

**Figure 9. MTTF Factor versus Junction Temperature**

### W-CDMA TEST SIGNAL

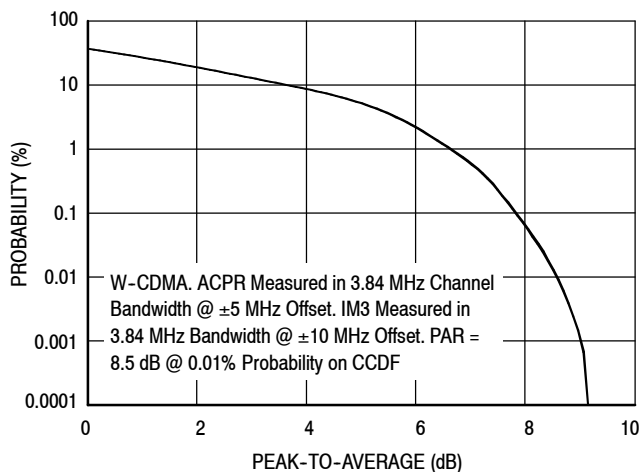

**Figure 10. CCDF W-CDMA 3GPP, Test Model 1, 64 DPCH, 67% Clipping, Single Carrier Test Signal**

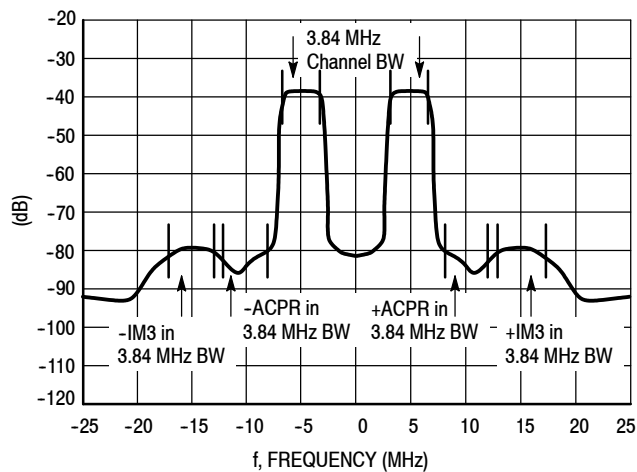

**Figure 11. 2-Carrier W-CDMA Spectrum**

ARCHIVE INFORMATION

ARCHIVE INFORMATION

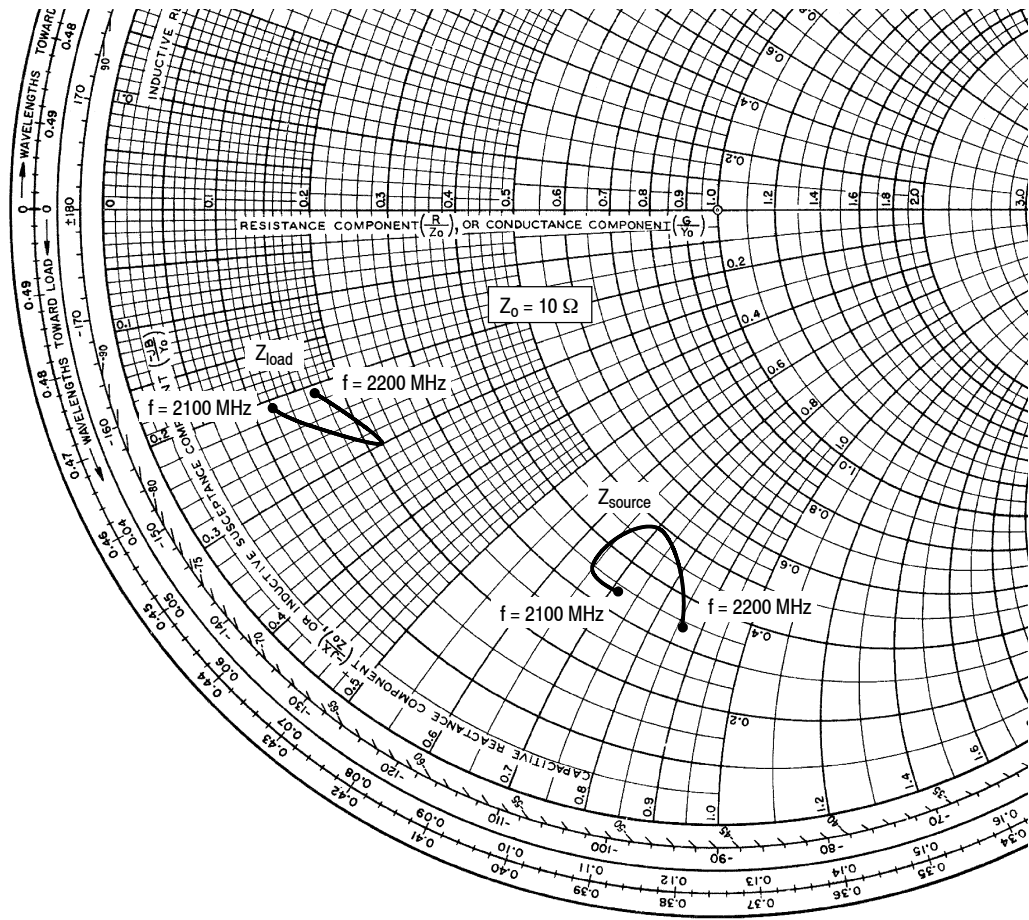

$V_{DD} = 28 \text{ Vdc}$ ,  $I_{DQ} = 1050 \text{ mA}$ ,  $P_{out} = 23 \text{ W Avg.}$

f MHz	$Z_{source}$ $\Omega$	$Z_{load}$ $\Omega$
2100	$3.4 - j7.2$	$1.2 - j2.1$
2120	$3.4 - j6.5$	$1.4 - j2.3$
2160	$4.9 - j7.0$	$2.2 - j3.0$
2200	$3.4 - j8.6$	$1.7 - j2.1$

$Z_{source}$  = Test circuit impedance as measured from gate to ground.

$Z_{load}$  = Test circuit impedance as measured from drain to ground.

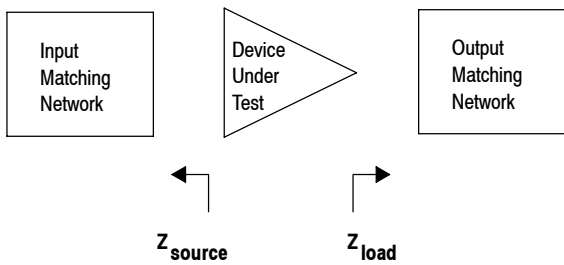
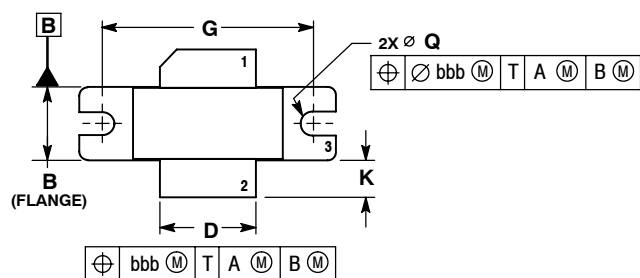

Figure 12. Series Equivalent Source and Load Impedance

### PACKAGE DIMENSIONS



- NOTES:
1. DIMENSIONING AND TOLERANCING PER ANSI Y14.5M-1994.
  2. CONTROLLING DIMENSION: INCH.
  3. DELETED
  4. DIMENSION H IS MEASURED 0.030 (0.762) AWAY FROM PACKAGE BODY.

DIM	INCHES		MILLIMETERS	
	MIN	MAX	MIN	MAX
A	1.335	1.345	33.91	34.16
B	0.380	0.390	9.65	9.91
C	0.125	0.170	3.18	4.32
D	0.495	0.505	12.57	12.83
E	0.035	0.045	0.89	1.14
F	0.003	0.006	0.08	0.15
G	1.100 BSC		27.94 BSC	
H	0.057	0.067	1.45	1.70
K	0.170	0.210	4.32	5.33
M	0.774	0.786	19.66	19.96
N	0.772	0.788	19.60	20.00
Q	Ø 1.18	Ø 1.38	Ø 3.00	Ø 3.51
R	0.365	0.375	9.27	9.53
S	0.365	0.375	9.27	9.52
aaa	0.005 REF		0.127 REF	
bbb	0.010 REF		0.254 REF	
ccc	0.015 REF		0.381 REF	

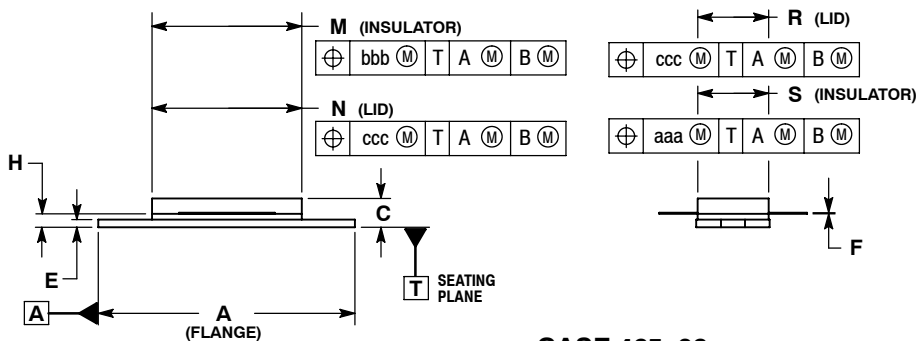

**CASE 465-06  
ISSUE G  
NI-780  
MRF5S21100HR3**

- STYLE 1:  
PIN 1. DRAIN  
2. GATE  
3. SOURCE

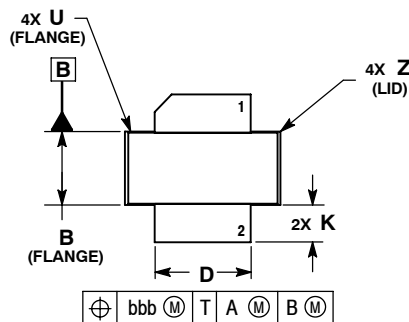

- NOTES:
1. DIMENSIONING AND TOLERANCING PER ANSI Y14.5M-1994.
  2. CONTROLLING DIMENSION: INCH.
  3. DELETED
  4. DIMENSION H IS MEASURED 0.030 (0.762) AWAY FROM PACKAGE BODY.

DIM	INCHES		MILLIMETERS	
	MIN	MAX	MIN	MAX
A	0.805	0.815	20.45	20.70
B	0.380	0.390	9.65	9.91
C	0.125	0.170	3.18	4.32
D	0.495	0.505	12.57	12.83
E	0.035	0.045	0.89	1.14
F	0.003	0.006	0.08	0.15
H	0.057	0.067	1.45	1.70
K	0.170	0.210	4.32	5.33
M	0.774	0.786	19.61	20.02
N	0.772	0.788	19.61	20.02
R	0.365	0.375	9.27	9.53
S	0.365	0.375	9.27	9.52
U	---	0.040	---	1.02
Z	---	0.030	---	0.76
aaa	0.005 REF		0.127 REF	
bbb	0.010 REF		0.254 REF	
ccc	0.015 REF		0.381 REF	

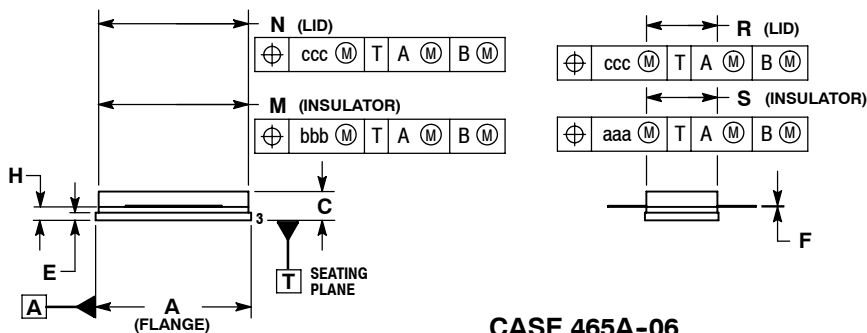

**CASE 465A-06  
ISSUE H  
NI-780S  
MRF5S21100HSR3**

- STYLE 1:  
PIN 1. DRAIN  
2. GATE  
5. SOURCE

## REVISION HISTORY

The following table summarizes revisions to this document.

Revision	Date	Description
4	Dec. 2010	<ul style="list-style-type: none"> <li>• Data sheet revised to reflect part status change, p. 1, including use of applicable overlay.</li> <li>• Modified data sheet to reflect RF Test Reduction described in Product and Process Change Notification number, PCN12779, p. 1, 2</li> <li>• Updated Part Numbers in Table 5, Component Designations and Values, to RoHS compliant part numbers, p. 3</li> <li>• Added Revision History, p. 9</li> <li>• Data sheet archived. Parts no longer manufactured.</li> </ul>

ARCHIVE INFORMATION

ARCHIVE INFORMATION

**How to Reach Us:**

**Home Page:**

[www.freescale.com](http://www.freescale.com)

**Web Support:**

<http://www.freescale.com/support>

**USA/Europe or Locations Not Listed:**

Freescale Semiconductor, Inc.  
 Technical Information Center, EL516  
 2100 East Elliot Road  
 Tempe, Arizona 85284  
 1-800-521-6274 or +1-480-768-2130  
[www.freescale.com/support](http://www.freescale.com/support)

**Europe, Middle East, and Africa:**

Freescale Halbleiter Deutschland GmbH  
 Technical Information Center  
 Schatzbogen 7  
 81829 Muenchen, Germany  
 +44 1296 380 456 (English)  
 +46 8 52200080 (English)  
 +49 89 92103 559 (German)  
 +33 1 69 35 48 48 (French)  
[www.freescale.com/support](http://www.freescale.com/support)

**Japan:**

Freescale Semiconductor Japan Ltd.  
 Headquarters  
 ARCO Tower 15F  
 1-8-1, Shimo-Meguro, Meguro-ku,  
 Tokyo 153-0064  
 Japan  
 0120 191014 or +81 3 5437 9125  
[support.japan@freescale.com](mailto:support.japan@freescale.com)

**Asia/Pacific:**

Freescale Semiconductor China Ltd.  
 Exchange Building 23F  
 No. 118 Jianguo Road  
 Chaoyang District  
 Beijing 100022  
 China  
 +86 10 5879 8000  
[support.asia@freescale.com](mailto:support.asia@freescale.com)

**For Literature Requests Only:**

Freescale Semiconductor Literature Distribution Center  
 1-800-441-2447 or +1-303-675-2140  
 Fax: +1-303-675-2150  
[LDCForFreescaleSemiconductor@hibbertgroup.com](mailto:LDCForFreescaleSemiconductor@hibbertgroup.com)

Information in this document is provided solely to enable system and software implementers to use Freescale Semiconductor products. There are no express or implied copyright licenses granted hereunder to design or fabricate any integrated circuits or integrated circuits based on the information in this document.

Freescale Semiconductor reserves the right to make changes without further notice to any products herein. Freescale Semiconductor makes no warranty, representation or guarantee regarding the suitability of its products for any particular purpose, nor does Freescale Semiconductor assume any liability arising out of the application or use of any product or circuit, and specifically disclaims any and all liability, including without limitation consequential or incidental damages. "Typical" parameters that may be provided in Freescale Semiconductor data sheets and/or specifications can and do vary in different applications and actual performance may vary over time. All operating parameters, including "Typicals", must be validated for each customer application by customer's technical experts. Freescale Semiconductor does not convey any license under its patent rights nor the rights of others. Freescale Semiconductor products are not designed, intended, or authorized for use as components in systems intended for surgical implant into the body, or other applications intended to support or sustain life, or for any other application in which the failure of the Freescale Semiconductor product could create a situation where personal injury or death may occur. Should Buyer purchase or use Freescale Semiconductor products for any such unintended or unauthorized application, Buyer shall indemnify and hold Freescale Semiconductor and its officers, employees, subsidiaries, affiliates, and distributors harmless against all claims, costs, damages, and expenses, and reasonable attorney fees arising out of, directly or indirectly, any claim of personal injury or death associated with such unintended or unauthorized use, even if such claim alleges that Freescale Semiconductor was negligent regarding the design or manufacture of the part.

Freescale™ and the Freescale logo are trademarks of Freescale Semiconductor, Inc. All other product or service names are the property of their respective owners.

© Freescale Semiconductor, Inc. 2006, 2010. All rights reserved.

## Looking for pricing, stock, or lifecycle information?

Click below to explore more details on WIN SOURCE:

- ⊖ [View MRF5S21100HR5 on WIN SOURCE](#)
- ⊖ [Freescale Semiconductor - NXP Information](#)

## Optimize Your Supply Chain with WIN SOURCE Solutions

- ✓ Global Sourcing Solution
- ✓ Obsolete Management
- ✓ Cost Control Management
- ✓ Shortage Management
- ✓ Alternative Solution
- ✓ Excess Inventory Management