



**THE DATASHEET OF
MRF6P3300HR5**



MRF6P3300HR3/HR5 replaced by MRFE6P3300HR3/HR5. Refer to Device Migration PCN12895 for more details.

RF Power Field Effect Transistor

N-Channel Enhancement-Mode Lateral MOSFETs

Designed for broadband commercial and industrial applications with frequencies from 470 to 860 MHz. The high gain and broadband performance of this device make it ideal for large-signal, common-source amplifier applications in 32 volt analog or digital television transmitter equipment.

- Typical Narrowband Two-Tone Performance @ 860 MHz: $V_{DD} = 32$ Volts, $I_{DQ} = 1600$ mA, $P_{out} = 270$ Watts PEP
 Power Gain — 20.2 dB
 Drain Efficiency — 44.1%
 IMD — -30.8 dBc
- Typical Narrowband DVB-T OFDM Performance @ 860 MHz: $V_{DD} = 32$ Volts, $I_{DQ} = 1600$ mA, $P_{out} = 60$ Watts Avg., 8K Mode, 64 QAM
 Power Gain — 20.4 dB
 Drain Efficiency — 29%
 ACPR @ 3.9 MHz Offset — -57 dBc @ 20 kHz Bandwidth
- Capable of Handling 10:1 VSWR, @ 32 Vdc, 860 MHz, 300 Watts CW Output Power

Features

- Characterized with Series Equivalent Large-Signal Impedance Parameters
- Internally Matched for Ease of Use
- Designed for Push-Pull Operation Only
- Qualified Up to a Maximum of 32 V_{DD} Operation
- Integrated ESD Protection
- RoHS Compliant
- In Tape and Reel. R3 Suffix = 250 Units per 56 mm, 13 inch Reel.
 R5 Suffix = 50 Units per 56 mm, 13 inch Reel.

MRF6P3300HR3
MRF6P3300HR5

470-860 MHz, 300 W, 32 V
LATERAL N-CHANNEL
RF POWER MOSFETS

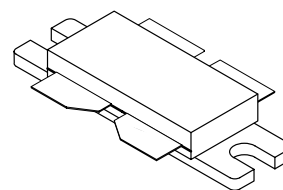

CASE 375G-04, STYLE 1
NI-860C3

ARCHIVE INFORMATION

ARCHIVE INFORMATION

Table 1. Maximum Ratings

Rating	Symbol	Value	Unit
Drain-Source Voltage	V_{DSS}	-0.5, +68	Vdc
Gate-Source Voltage	V_{GS}	-0.5, +12	Vdc
Storage Temperature Range	T_{stg}	-65 to +150	°C
Case Operating Temperature	T_C	150	°C
Operating Junction Temperature (1,2)	T_J	225	°C

Table 2. Thermal Characteristics

Characteristic	Symbol	Value (2,3)	Unit
Thermal Resistance, Junction to Case	$R_{\theta JC}$		°C/W
Case Temperature 80°C, 300 W CW		0.23	
Case Temperature 82°C, 220 W CW		0.24	
Case Temperature 79°C, 100 W CW		0.27	
Case Temperature 81°C, 60 W CW		0.27	

1. Continuous use at maximum temperature will affect MTTF.
2. MTTF calculator available at <http://www.freescale.com/rf>. Select Software & Tools/Development Tools/Calculators to access MTTF calculators by product.
3. Refer to AN1955, *Thermal Measurement Methodology of RF Power Amplifiers*. Go to <http://www.freescale.com/rf>. Select Documentation/Application Notes - AN1955.

Table 3. ESD Protection Characteristics

Test Methodology	Class
Human Body Model (per JESD22-A114)	3B (Minimum)
Machine Model (per EIA/JESD22-A115)	C (Minimum)
Charge Device Model (per JESD22-C101)	IV (Minimum)

Table 4. Electrical Characteristics ($T_C = 25^\circ\text{C}$ unless otherwise noted)

Characteristic	Symbol	Min	Typ	Max	Unit
Off Characteristics (1)					
Zero Gate Voltage Drain Leakage Current (4) ($V_{DS} = 68\text{ Vdc}$, $V_{GS} = 0\text{ Vdc}$)	I_{DSS}	—	—	10	μAdc
Zero Gate Voltage Drain Leakage Current (4) ($V_{DS} = 32\text{ Vdc}$, $V_{GS} = 0\text{ Vdc}$)	I_{DSS}	—	—	1	μAdc
Gate-Source Leakage Current ($V_{GS} = 5\text{ Vdc}$, $V_{DS} = 0\text{ Vdc}$)	I_{GSS}	—	—	1	μAdc

On Characteristics (1)

Gate Threshold Voltage ($V_{DS} = 10\text{ Vdc}$, $I_D = 350\ \mu\text{Adc}$)	$V_{GS(th)}$	1	2.2	3	Vdc
Gate Quiescent Voltage ($V_{DD} = 32\text{ Vdc}$, $I_D = 1600\text{ mAdc}$, Measured in Functional Test)	$V_{GS(Q)}$	2	2.8	4	Vdc
Drain-Source On-Voltage ($V_{GS} = 10\text{ Vdc}$, $I_D = 2.4\text{ Adc}$)	$V_{DS(on)}$	—	0.22	0.3	Vdc

Dynamic Characteristics (1,2)

Reverse Transfer Capacitance ($V_{DS} = 32\text{ Vdc} \pm 30\text{ mV(rms)ac}$ @ 1 MHz, $V_{GS} = 0\text{ Vdc}$)	C_{rss}	—	1.4	—	pF
---	-----------	---	-----	---	----

Functional Tests (3) (In Freescale Narrowband Test Fixture, 50 ohm system) $V_{DD} = 32\text{ Vdc}$, $I_{DQ} = 1600\text{ mA}$, $P_{out} = 270\text{ W PEP}$, $f_1 = 857\text{ MHz}$, $f_2 = 863\text{ MHz}$

Power Gain	G_{ps}	19	20.2	23	dB
Drain Efficiency	η_D	41	44.1	—	%
Intermodulation Distortion	IMD	—	-30.8	-28	dBc
Input Return Loss	IRL	—	-24	-9	dB
P_{out} @ 1 dB Compression Point, CW ($f = 860\text{ MHz}$)	P1dB	—	320	—	W

- Each side of the device measured separately.
- Part internally matched both on input and output.
- Measurement made with device in push-pull configuration.
- Drains are tied together internally as this is a total device value.

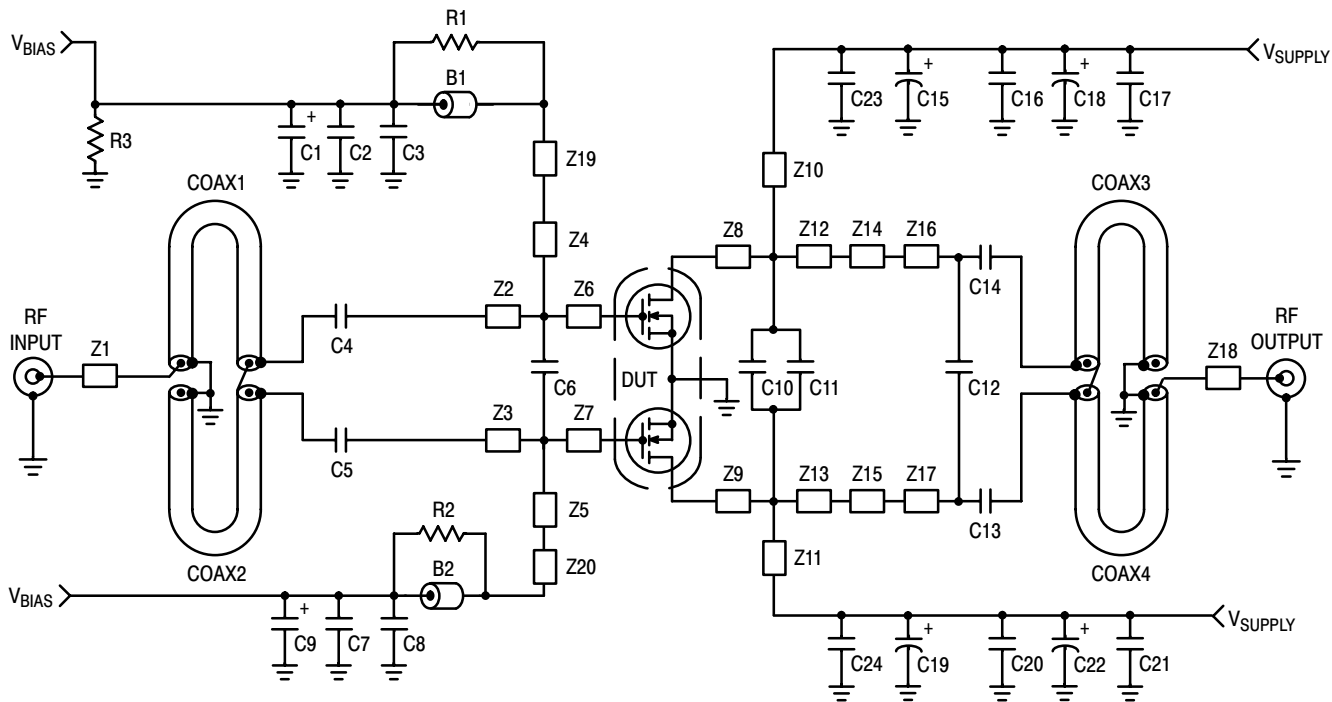

Z1	0.401" x 0.081" Microstrip	Z12, Z13	0.225" x 0.507" Microstrip
Z2, Z3	0.563" x 0.101" Microstrip	Z14, Z15	0.440" x 0.435" Microstrip
Z4, Z5	1.186" x 0.058" Microstrip	Z16, Z17	0.123" x 0.215" Microstrip
Z6, Z7	0.416" x 0.727" Microstrip	Z18	0.401" x 0.081" Microstrip
Z8, Z9	0.191" x 0.507" Microstrip	Z19, Z20	0.339" x 0.165" Microstrip
Z10, Z11	1.306" x 0.150" Microstrip	PCB	Arlon CuClad 250GX-0300-55-22, 0.030", $\epsilon_r = 2.55$

Figure 1. 820-900 MHz Narrowband Test Circuit Schematic

Table 5. 820-900 MHz Narrowband Test Circuit Component Designations and Values

Part	Description	Part Number	Manufacturer
B1, B2	Ferrite Beads, Short	2743019447	Fair-Rite
C1, C9	1.0 μ F, 50 V Tantalum Chip Capacitors	T491C105K050AT	Kemet
C2, C7, C17, C21	0.1 μ F, 50 V Chip Capacitors	CDR33BX104AKYS	Kemet
C3, C8, C16, C20	1000 pF Chip Capacitors	ATC100B102JT50XT	ATC
C4, C5, C13, C14	100 pF Chip Capacitors	ATC100B101JT500XT	ATC
C6, C12	8.2 pF Chip Capacitors	ATC100B8R2JT500XT	ATC
C10	9.1 pF Chip Capacitor	ATC100B9R1BT500XT	ATC
C11	1.8 pF Chip Capacitor	ATC100B1R8BT500XT	ATC
C15, C19	47 μ F, 50 V Electrolytic Capacitors	EMVY500ADA470MF80G	Nippon
C18, C22	470 μ F, 63 V Electrolytic Capacitors	ESME630ELL471MK25S	United Chemi-Con
C23, C24	22 pF Chip Capacitors	ATC100B220FT500XT	ATC
Coax1, 2, 3, 4	50 Ω , Semi Rigid Coax, 2.06" Long	UT-141A-TP	Micro-Coax
R1, R2	10 Ω , 1/4 W Chip Resistors	CRCW120610R0FKEA	Vishay
R3	1 k Ω , 1/4 W Chip Resistor	CRCW12061001FKEA	Vishay

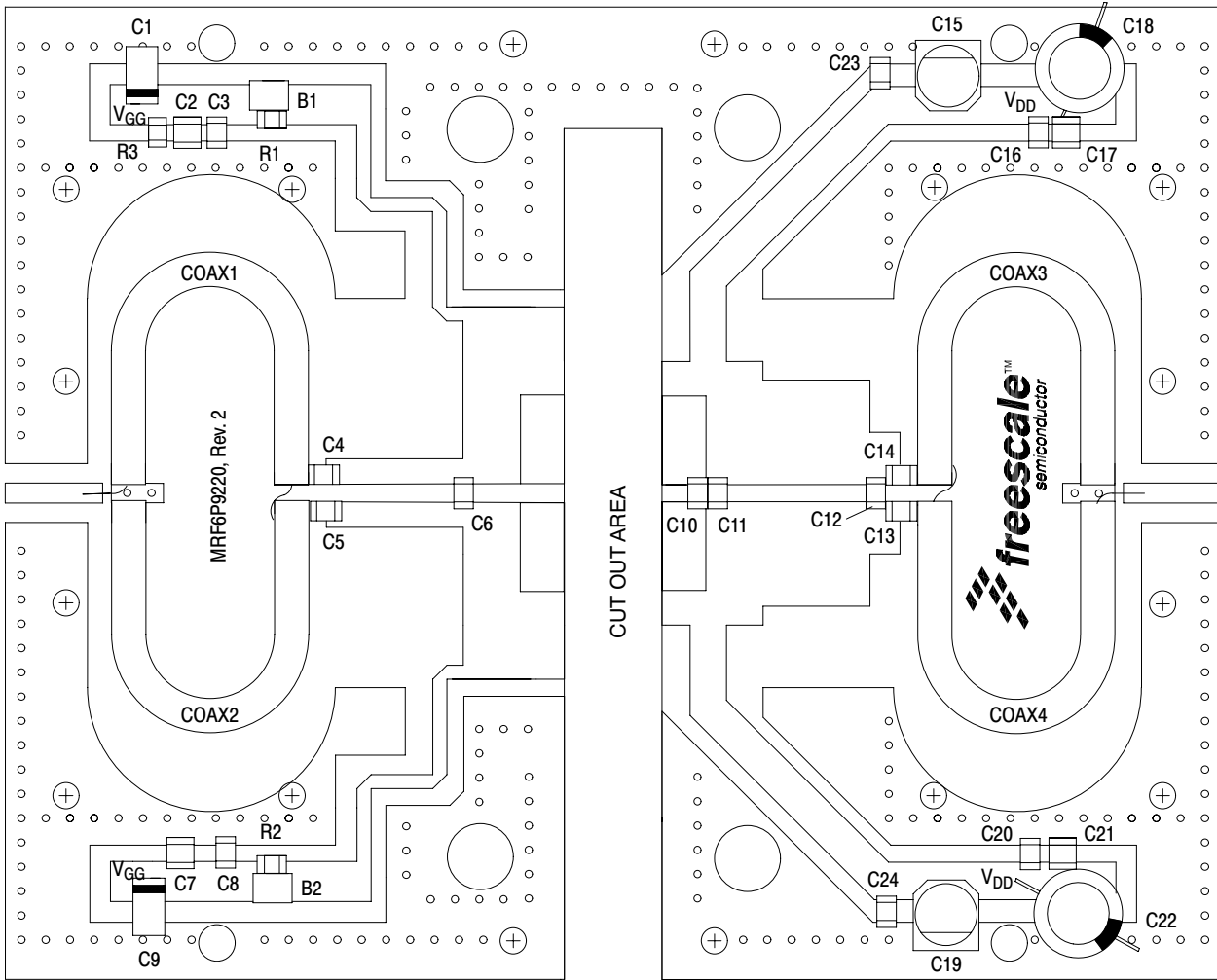

Figure 2. 820-900 MHz Narrowband Test Circuit Component Layout

TYPICAL NARROWBAND CHARACTERISTICS

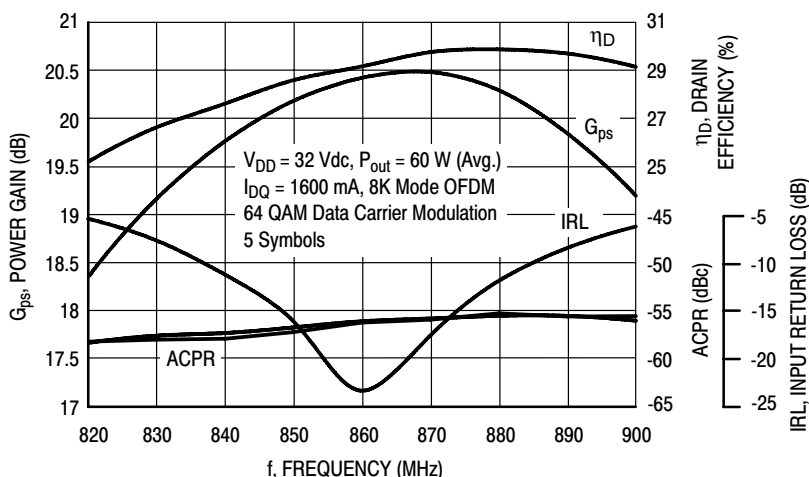

Figure 3. Single-Carrier OFDM Broadband Performance @ 60 Watts Avg.

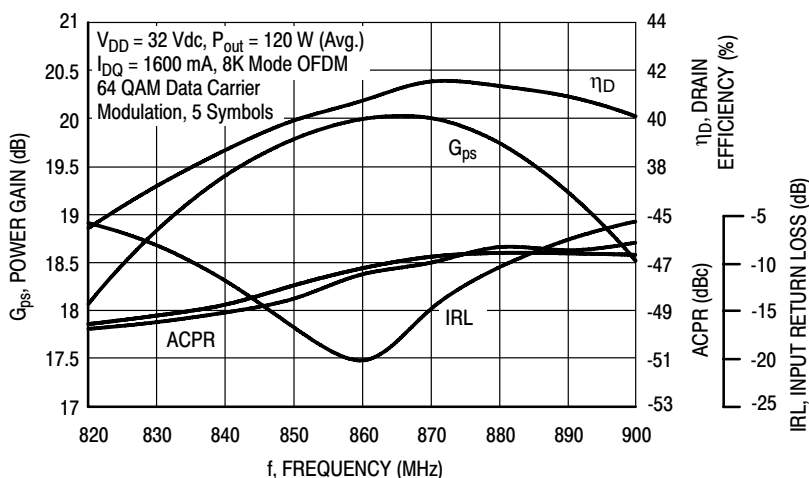

Figure 4. Single-Carrier OFDM Broadband Performance @ 120 Watts Avg.

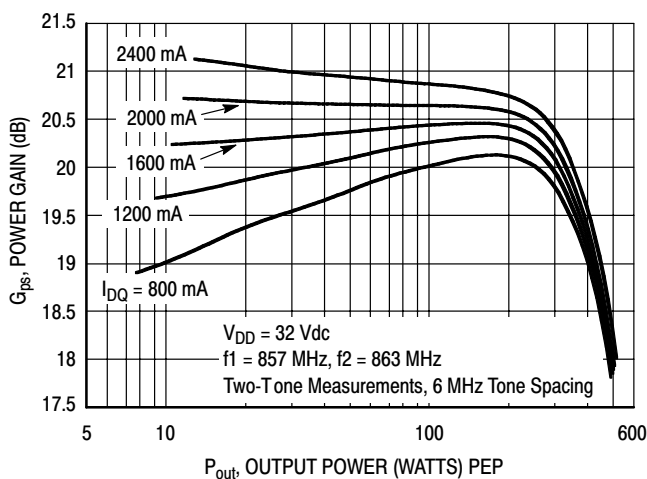

Figure 5. Two-Tone Power Gain versus Output Power

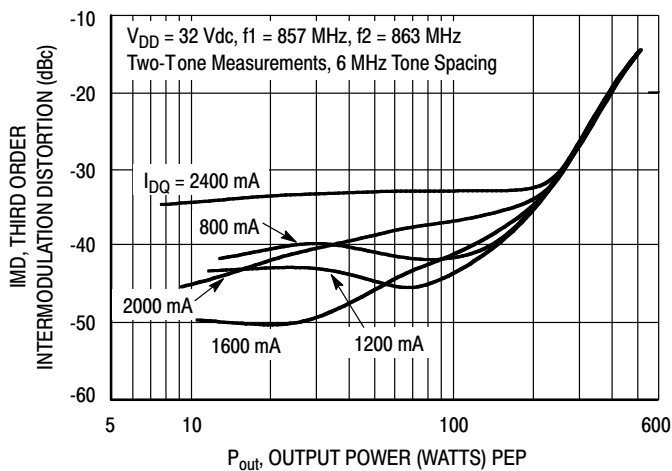

Figure 6. Third Order Intermodulation Distortion versus Output Power

ARCHIVE INFORMATION

ARCHIVE INFORMATION

TYPICAL NARROWBAND CHARACTERISTICS

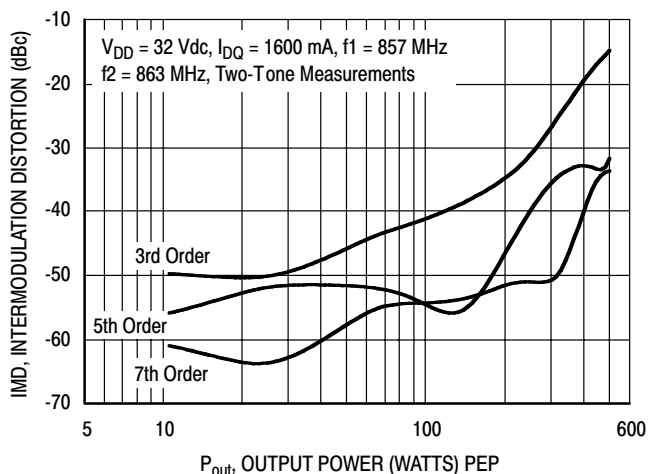

Figure 7. Intermodulation Distortion Products versus Output Power

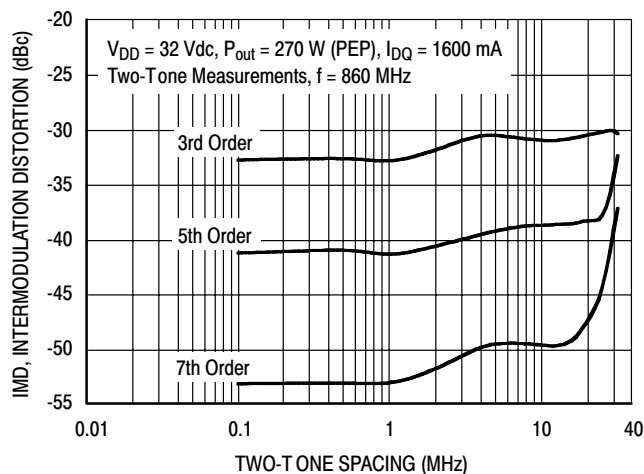

Figure 8. Intermodulation Distortion Products versus Tone Spacing @ 860 MHz

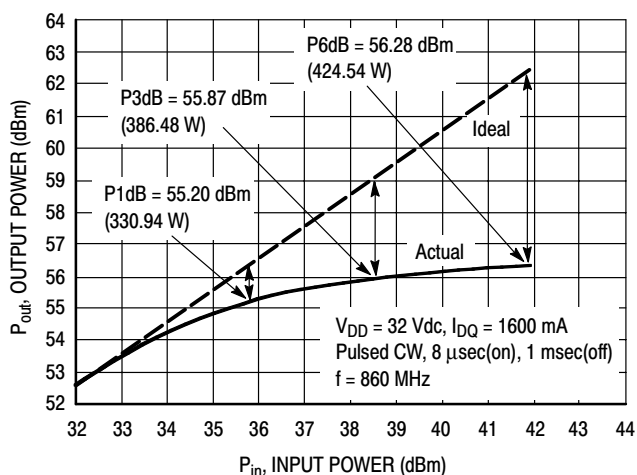

Figure 9. Pulsed CW Output Power versus Input Power

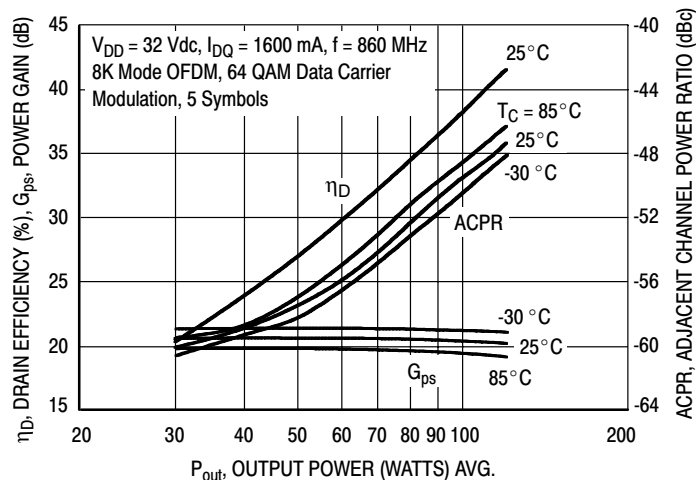

Figure 10. Single-Carrier DVB-T OFDM ACPR, Power Gain and Drain Efficiency versus Output Power

ARCHIVE INFORMATION

ARCHIVE INFORMATION

TYPICAL NARROWBAND CHARACTERISTICS

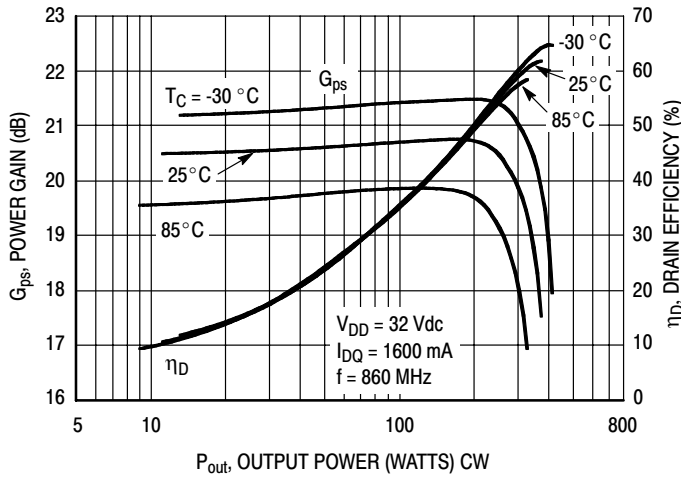

Figure 11. Power Gain and Drain Efficiency versus CW Output Power

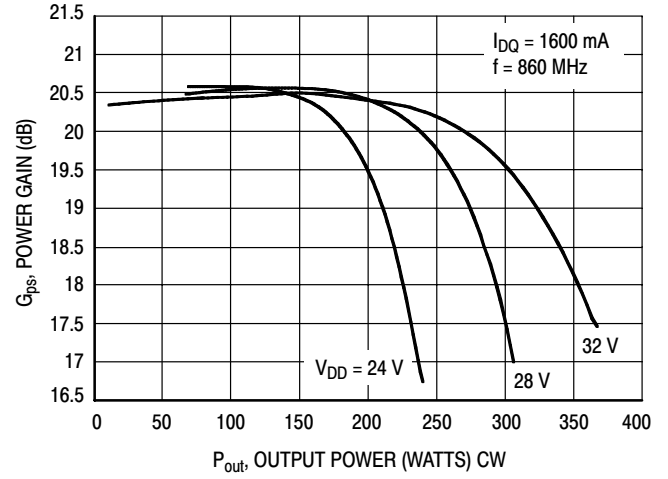
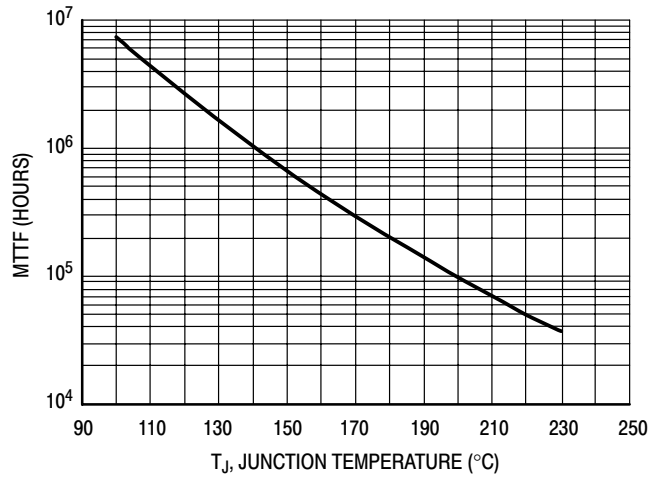

Figure 12. Power Gain versus Output Power



This above graph displays calculated MTTF in hours when the device is operated at $V_{DD} = 32$ Vdc, $P_{out} = 270$ W PEP, and $\eta_D = 44.1\%$.
 MTTF calculator available at <http://www.freescale.com/rf>. Select Software & Tools/Development Tools/Calculators to access MTTF calculators by product.

Figure 13. MTTF versus Junction Temperature

ARCHIVE INFORMATION

ARCHIVE INFORMATION

DIGITAL TEST SIGNALS

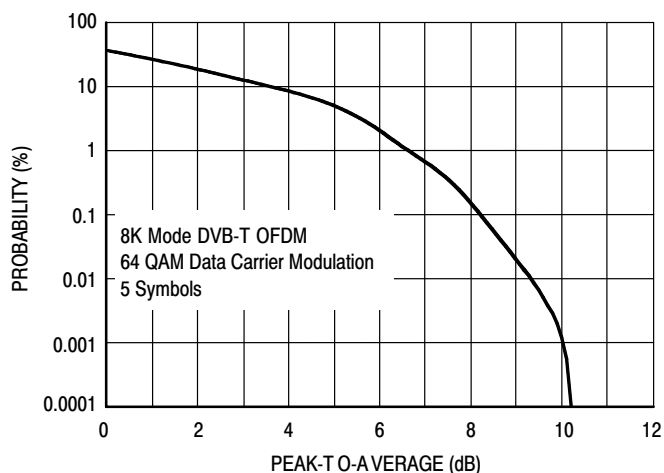

Figure 14. Single-Carrier DVB-T OFDM

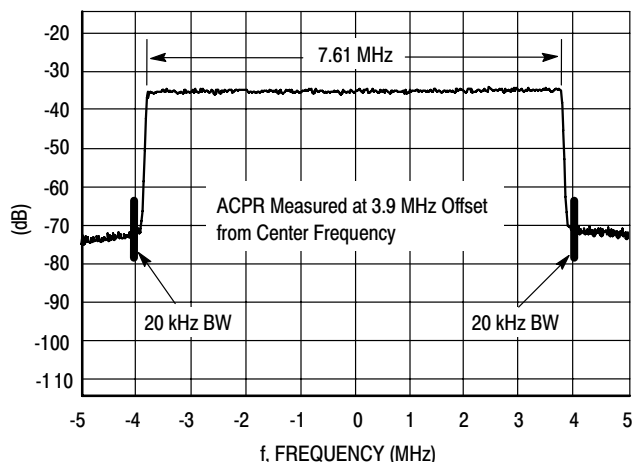

Figure 15. 8K Mode DVB-T OFDM Spectrum

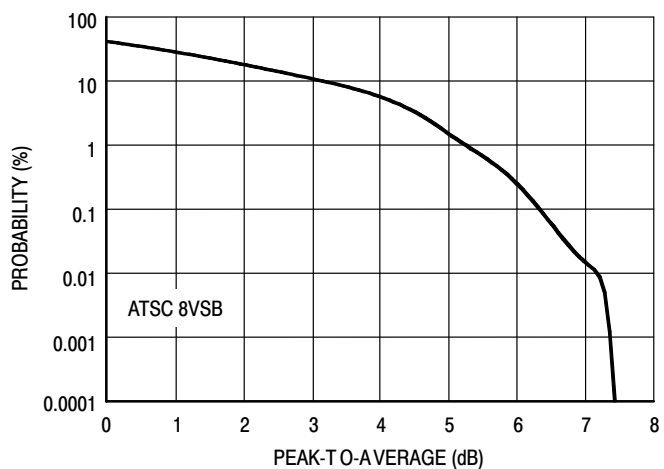

Figure 16. Single-Carrier ATSC 8VSB

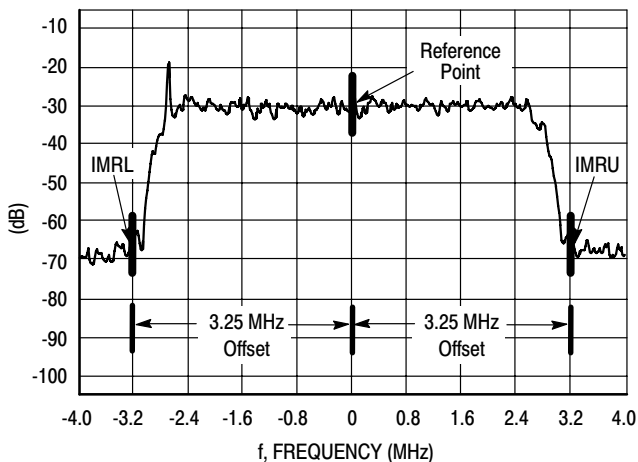
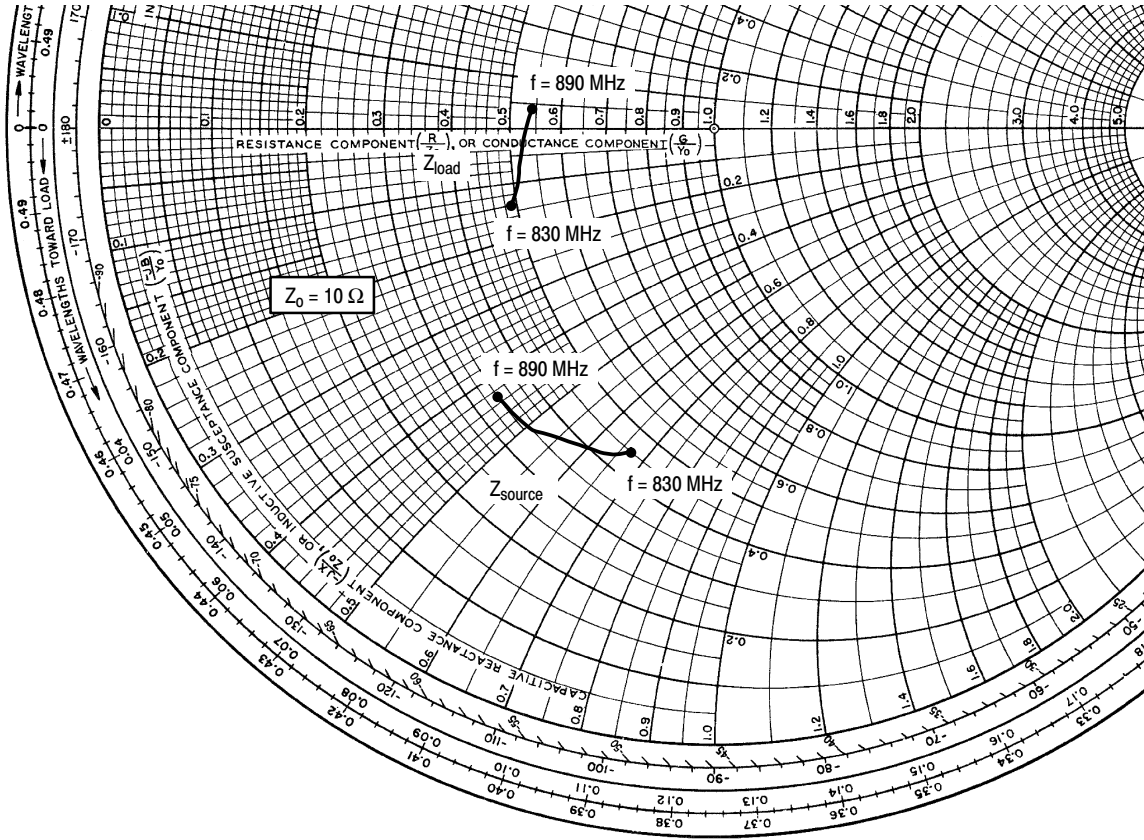

Figure 17. ATSC 8VSB Spectrum

ARCHIVE INFORMATION

ARCHIVE INFORMATION



$V_{DD} = 32 \text{ Vdc}$, $I_{DQ} = 1600 \text{ mA}$, $P_{out} = 270 \text{ W PEP}$

f MHz	Z_{source} Ω	Z_{load} Ω
830	$4.52 - j6.73$	$4.89 - j1.35$
845	$4.22 - j6.38$	$5.06 - j1.01$
860	$3.89 - j5.81$	$5.18 - j0.58$
875	$3.54 - j5.10$	$5.27 - j0.11$
890	$3.39 - j4.32$	$5.36 + j0.43$

Z_{source} = Test circuit impedance as measured from gate to gate, balanced configuration.

Z_{load} = Test circuit impedance as measured from drain to drain, balanced configuration.

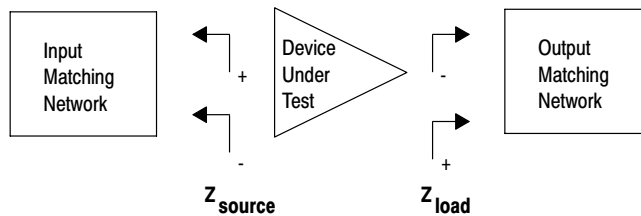
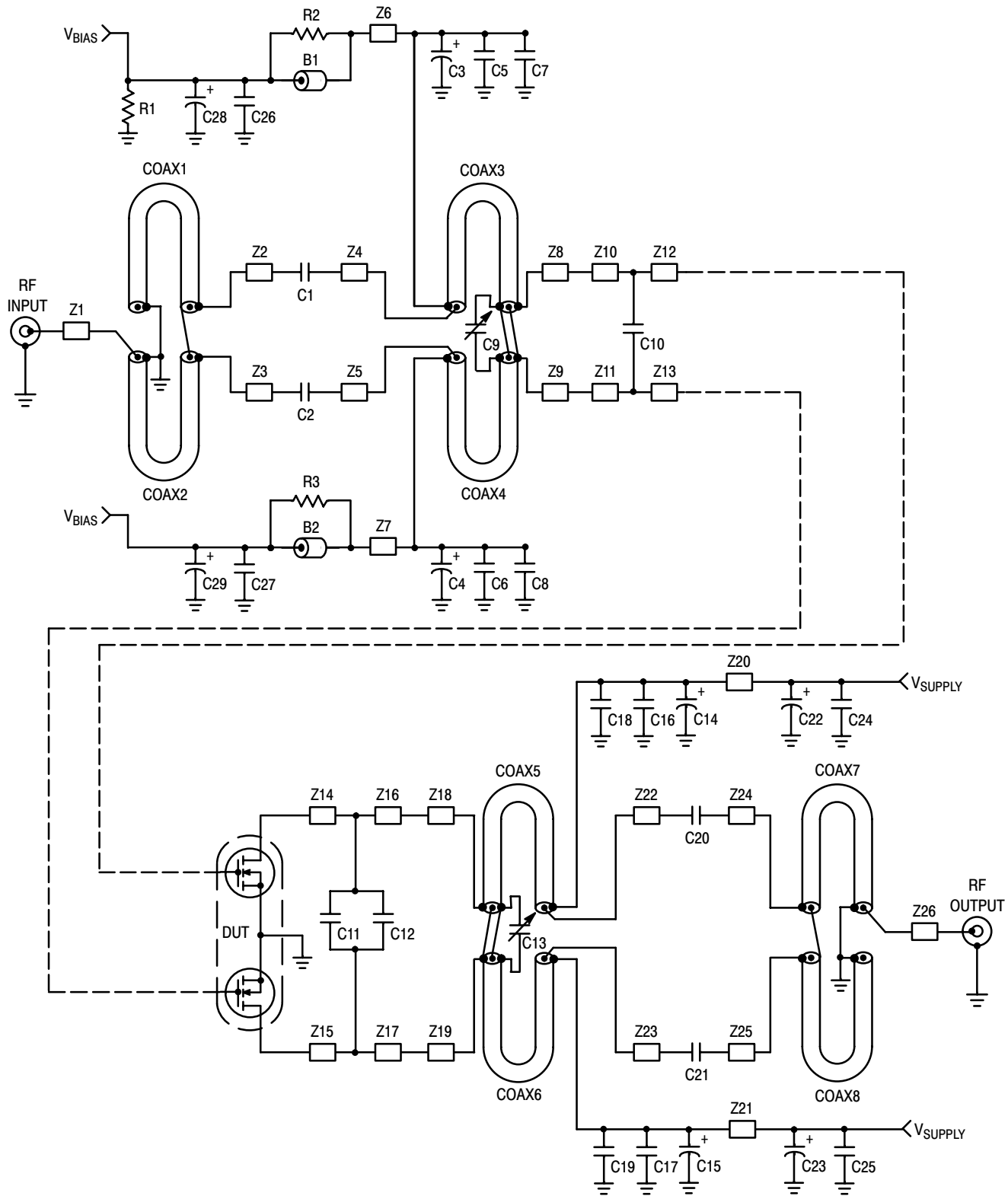

Figure 18. 820-900 MHz Narrowband Series Equivalent Source and Load Impedance



Z1	0.351" x 0.081" Microstrip	Z16, Z17	0.072" x 0.420" Microstrip
Z2, Z3	0.139" x 0.214" Microstrip	Z18, Z19	0.072" x 0.031" Microstrip
Z4, Z5	0.364" x 0.214" Microstrip	Z20, Z21	1.404" x 0.141" Microstrip
Z6, Z7	1.154" x 0.051" Microstrip	Z22, Z23	0.363" x 0.214" Microstrip
Z8, Z9	0.086" x 0.100" Microstrip	Z24, Z25	0.139" x 0.214" Microstrip
Z10, Z11	0.184" x 0.802" Microstrip	Z26	0.351" x 0.081" Microstrip
Z12, Z13	0.164" x 0.802" Microstrip	PCB	Arlon CuClad 250GX-0300-55-22, 0.030", $\epsilon_r = 2.5$
Z14, Z15	0.276" x 0.420" Microstrip		

Figure 19. 470-860 MHz Broadband Test Circuit Schematic

Table 6. 470-860 MHz Broadband Test Circuit Component Designations and Values

Part	Description	Part Number	Manufacturer
B1, B2	Ferrite Beads, Short	2743019447	Fair-Rite
C1, C2, C20, C21	43 pF Chip Capacitors	ATC700B430FT500XT	ATC
C3, C4, C14, C15	100 μ F, 50 V Electrolytic Capacitors	515D107M050BB6AE3	Vishay
C5, C6, C16, C17	220 nF, 100 V Chip Capacitors	C1812C224K5RAC	Kemet
C7, C8, C18, C19	0.01 μ F, 100 V Chip Capacitors	C1210C103J1RAC	Kemet
C9, C13	0.8-8.0 pF Variable Capacitors, Gigatrim	27291SL	Johanson
C10	15 pF 600B Chip Capacitor	ATC600S150FT250XT	ATC
C11	16 pF 600B Chip Capacitor	ATC600B160FT250XT	ATC
C12	4.3 pF 600B Chip Capacitor	ATC600B4R3BT250XT	ATC
C22, C23	470 μ F, 63 V Electrolytic Capacitors	EMVY630GTR471MLN0S	Nippon
C24, C25, C26, C27	0.1 μ F, 50 V Chip Capacitors	CDR33BX104AKYS	Kemet
C28, C29	10 μ F, 50 V Electrolytic Capacitors	ECE-V1HA100SP	Nippon Chemi-Con
Coax1, 2, 7, 8	50 Ω , Semi Rigid Coax, 3.00" Long	UT-141C-50-SP	Micro-Coax
Coax3, 4, 5, 6	25 Ω , Semi Rigid Coax, 3.00" Long	UT-141C-25	Micro-Coax
R1	1 k Ω , 1/8 W Resistor	CRCW12061001FKEA	Vishay
R2, R3	10 Ω , 1/8 W Resistors	CRCW120610R0FKEA	Vishay

ARCHIVE INFORMATION

ARCHIVE INFORMATION

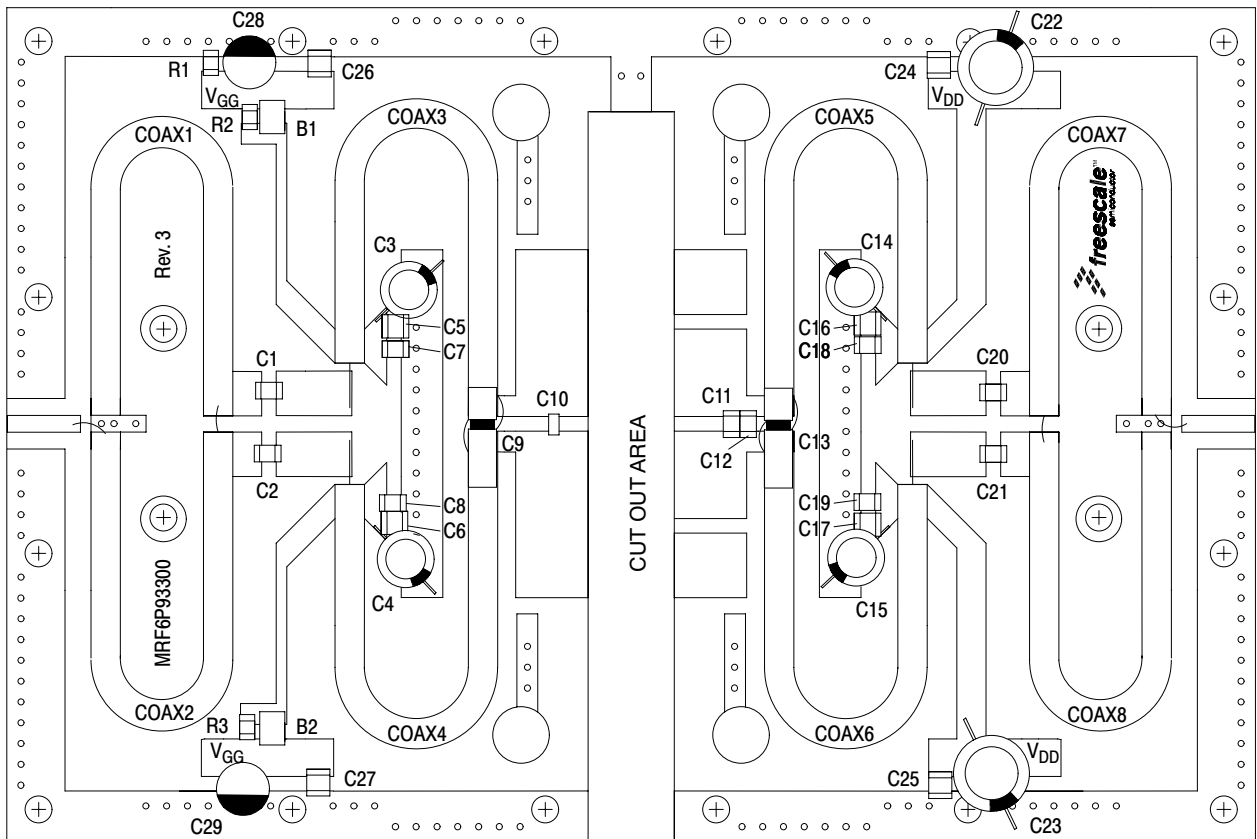

Figure 20. 470-860 MHz Broadband Test Circuit Component Layout

TYPICAL TWO-TONE BROADBAND CHARACTERISTICS

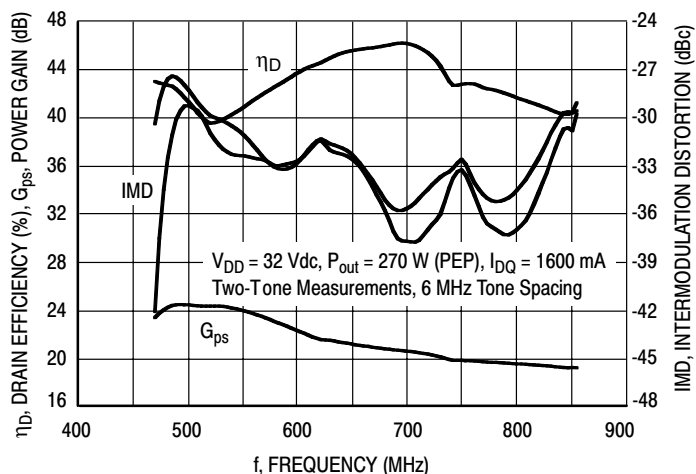

Figure 21. Two-Tone Broadband Performance @ $P_{out} = 270$ Watts PEP

ARCHIVE INFORMATION

ARCHIVE INFORMATION

TYPICAL TWO-TONE BROADBAND CHARACTERISTICS

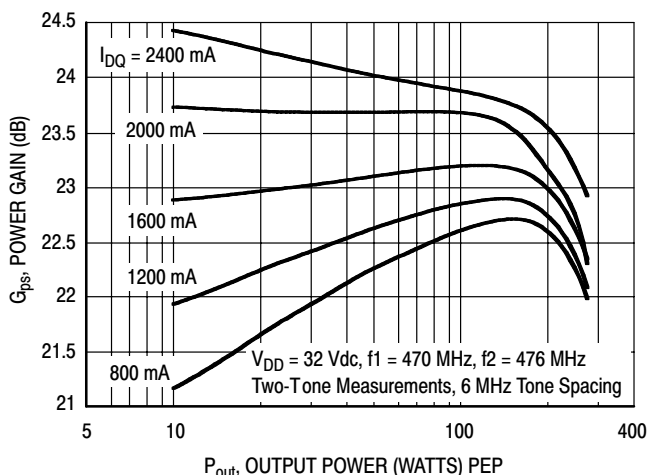

Figure 22. Two-Tone Power Gain versus Output Power @ 473 MHz

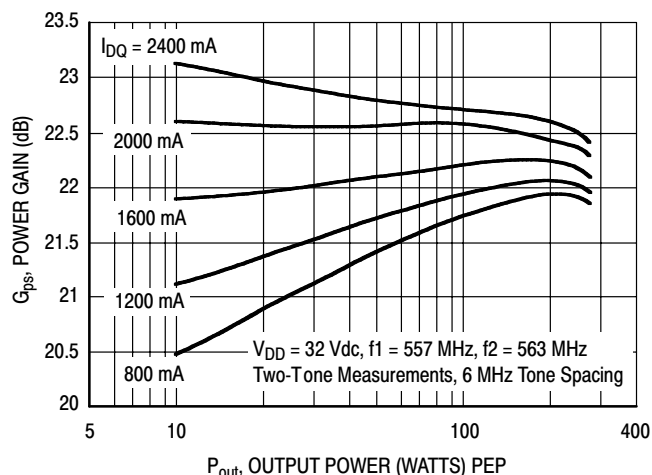

Figure 23. Two-Tone Power Gain versus Output Power @ 560 MHz

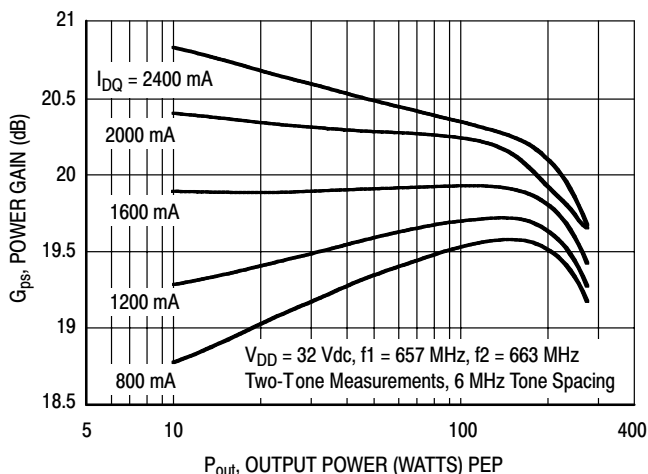

Figure 24. Two-Tone Power Gain versus Output Power @ 660 MHz

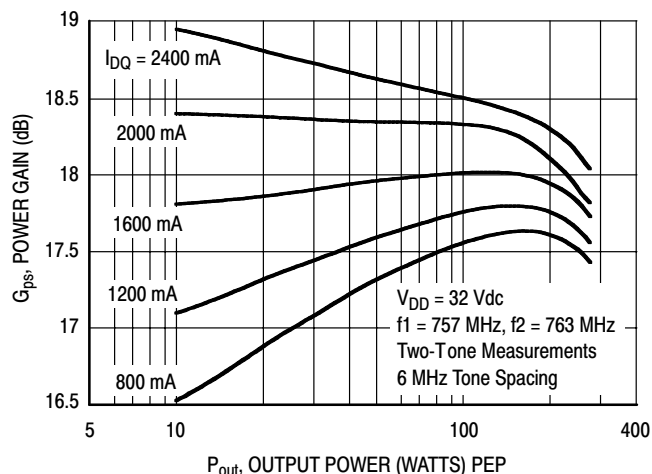

Figure 25. Two-Tone Power Gain versus Output Power @ 760 MHz

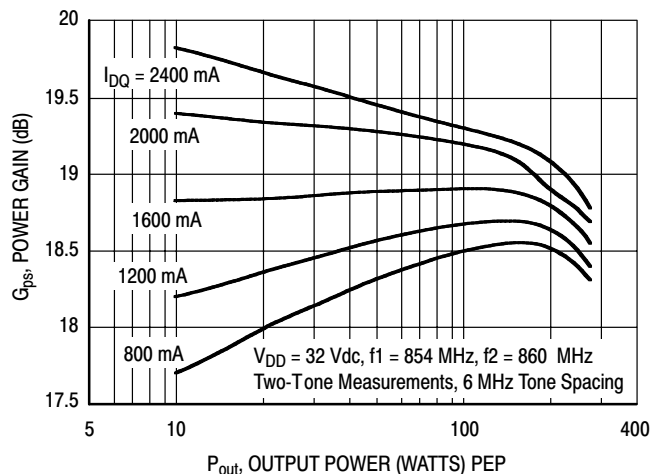

Figure 26. Two-Tone Power Gain versus Output Power @ 857 MHz

ARCHIVE INFORMATION

ARCHIVE INFORMATION

TYPICAL TWO-TONE BROADBAND CHARACTERISTICS

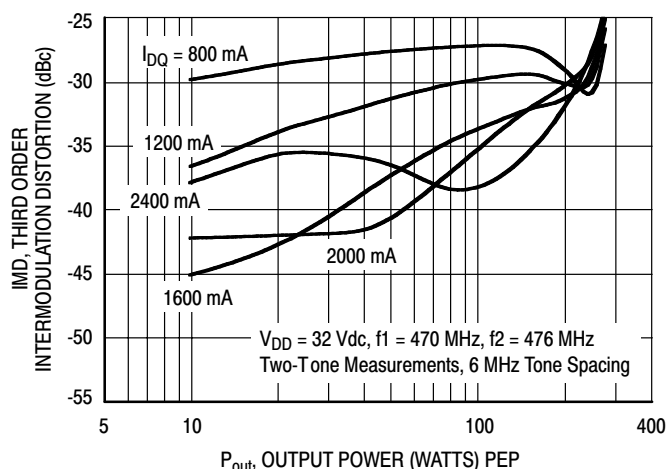

Figure 27. Third Order Intermodulation Distortion versus Output Power @ 473 MHz

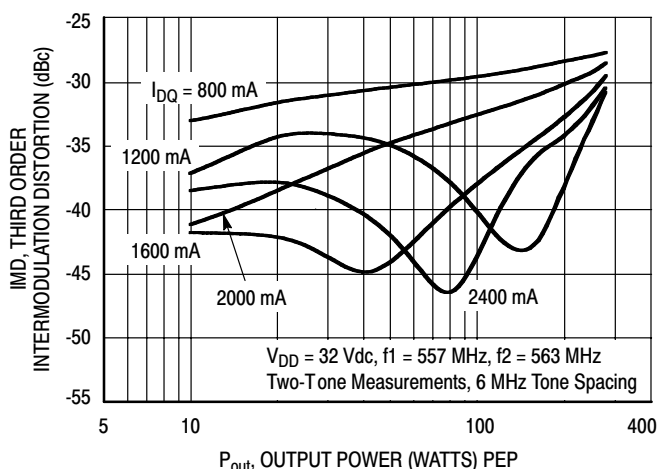

Figure 28. Third Order Intermodulation Distortion versus Output Power @ 560 MHz

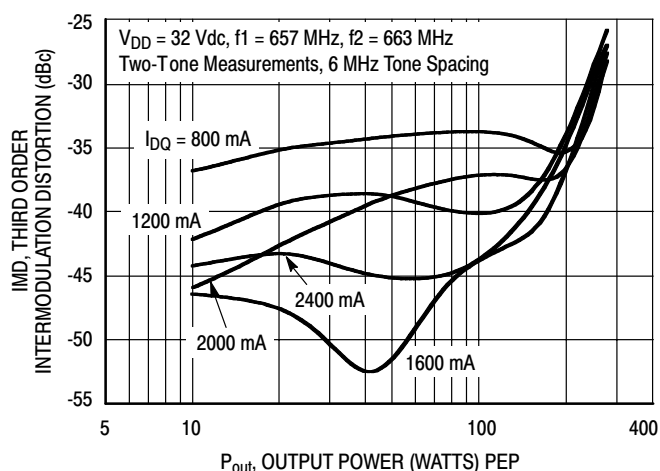

Figure 29. Third Order Intermodulation Distortion versus Output Power @ 660 MHz

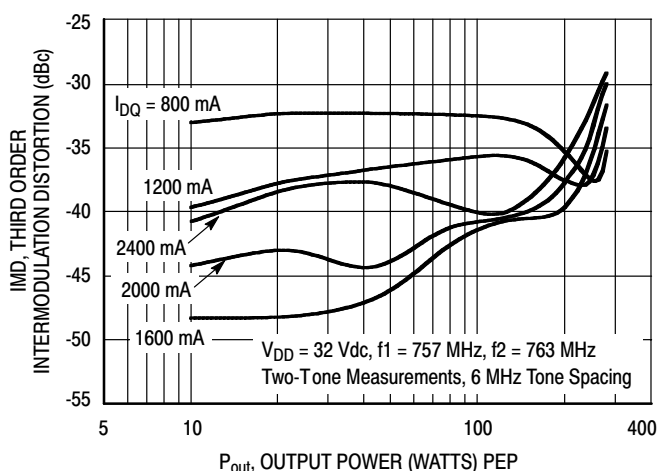

Figure 30. Third Order Intermodulation Distortion versus Output Power @ 760 MHz

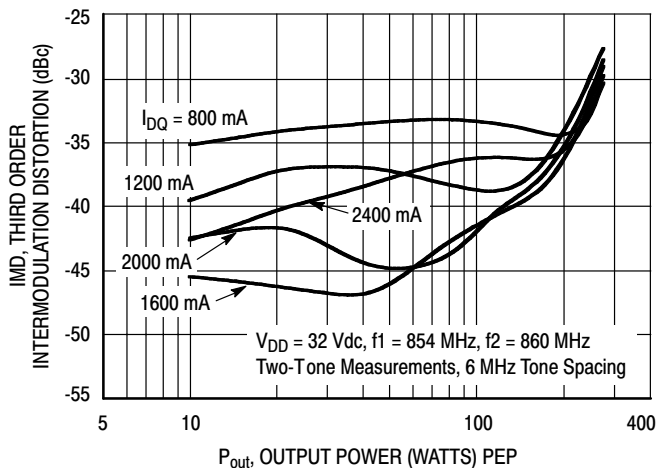

Figure 31. Third Order Intermodulation Distortion versus Output Power @ 857 MHz

ARCHIVE INFORMATION

ARCHIVE INFORMATION

TYPICAL TWO-TONE BROADBAND CHARACTERISTICS

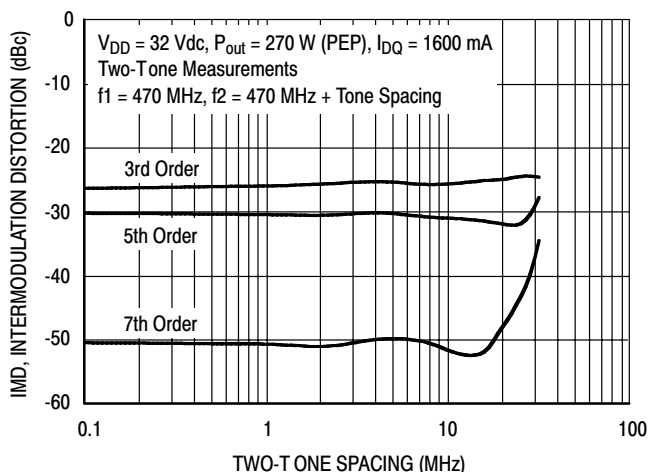

Figure 32. Intermodulation Distortion Products versus Tone Spacing @ 470 MHz

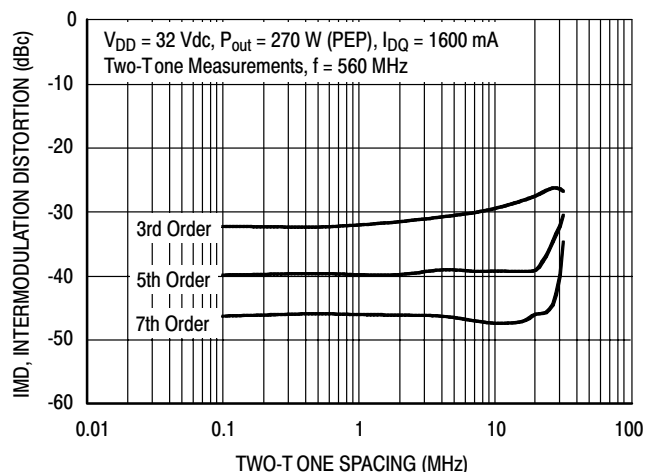

Figure 33. Intermodulation Distortion Products versus Tone Spacing @ 560 MHz

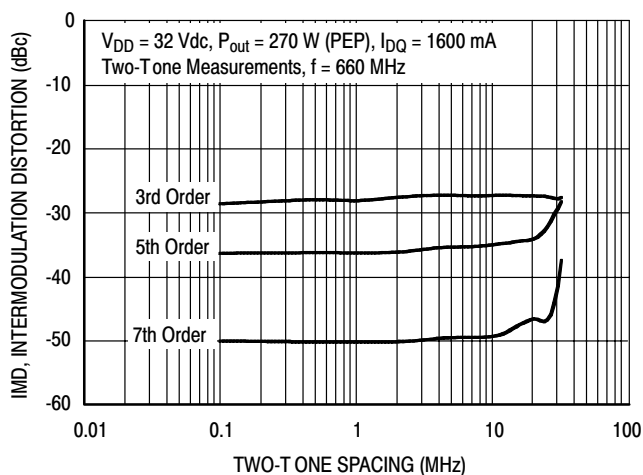

Figure 34. Intermodulation Distortion Products versus Tone Spacing @ 660 MHz

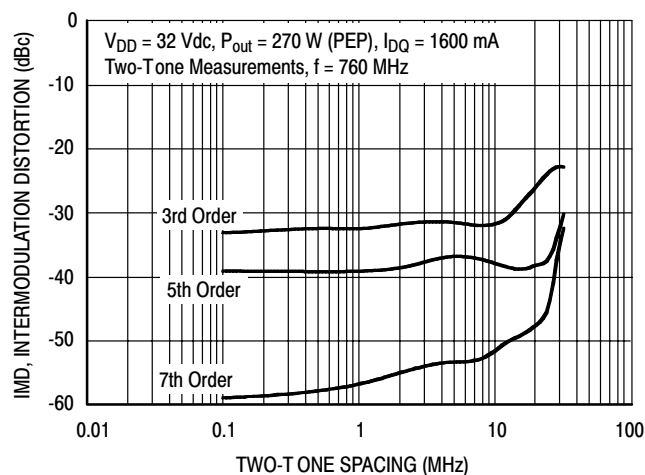

Figure 35. Intermodulation Distortion Products versus Tone Spacing @ 760 MHz

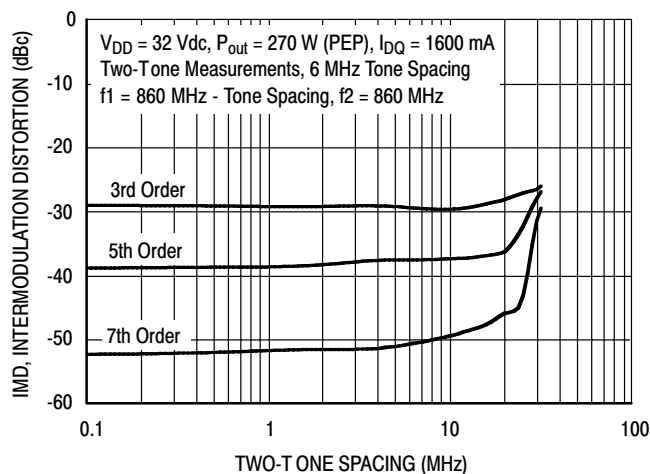

Figure 36. Intermodulation Distortion Products versus Tone Spacing @ 860 MHz

ARCHIVE INFORMATION

ARCHIVE INFORMATION

TYPICAL DVB-T OFDM BROADBAND CHARACTERISTICS

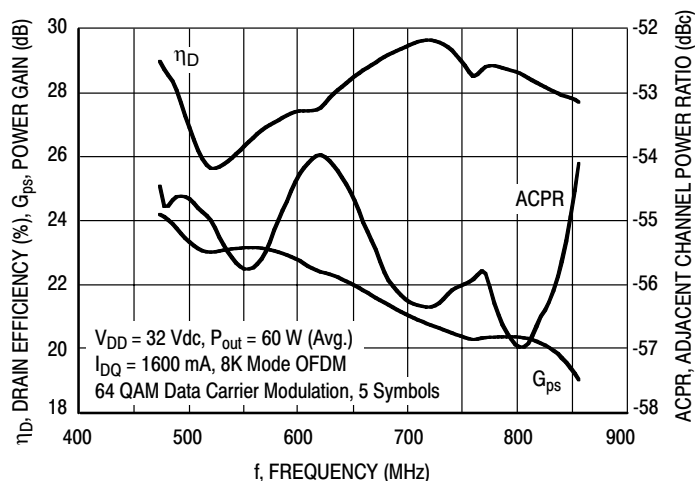

Figure 37. Single-Carrier OFDM Broadband Performance @ 60 Watts Avg.

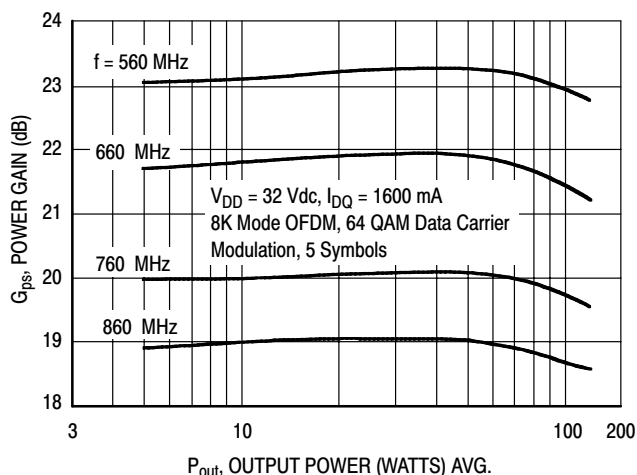

Figure 38. Single-Carrier DVB-T OFDM Power Gain versus Output Power

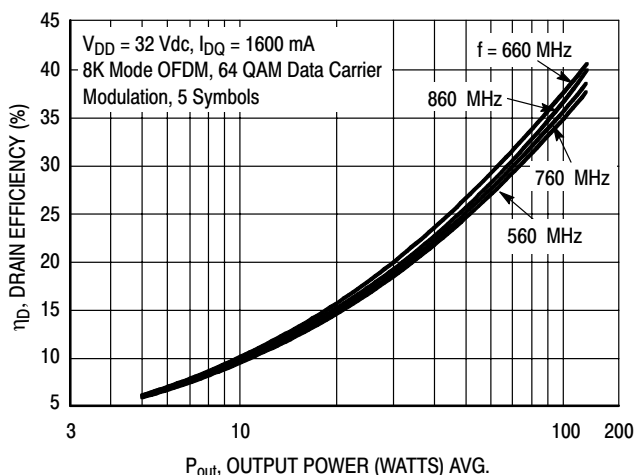

Figure 39. Single-Carrier DVB-T OFDM Drain Efficiency versus Output Power

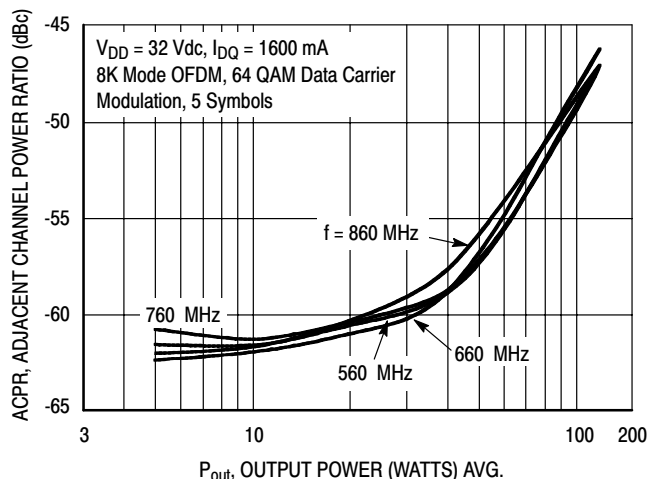

Figure 40. Single-Carrier DVB-T OFDM ACPR versus Output Power

TYPICAL CW BROADBAND CHARACTERISTICS

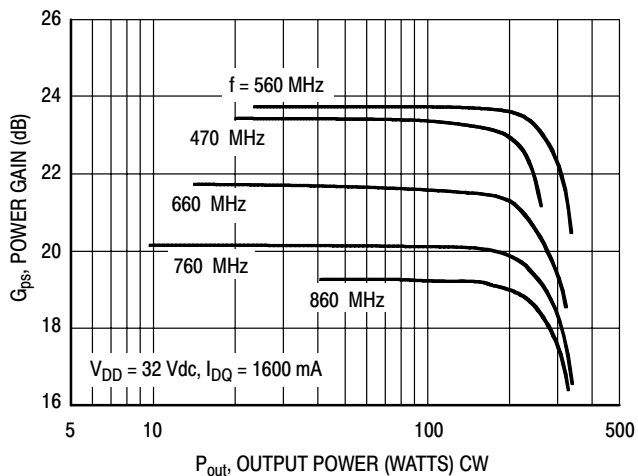

Figure 41. CW Power Gain versus Output Power

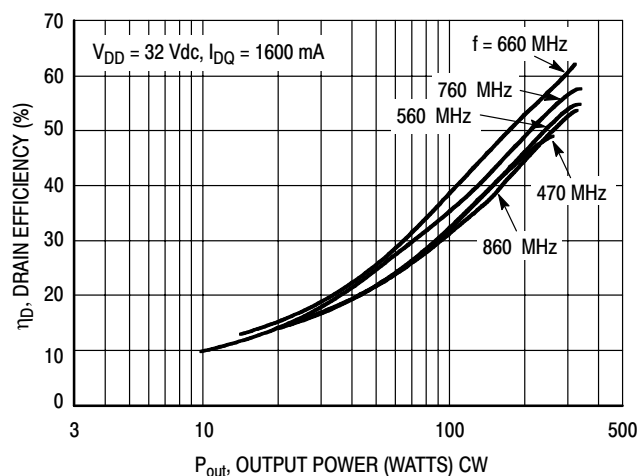

Figure 42. CW Drain Efficiency versus Output Power

ARCHIVE INFORMATION

ARCHIVE INFORMATION

TYPICAL CW BROADBAND CHARACTERISTICS

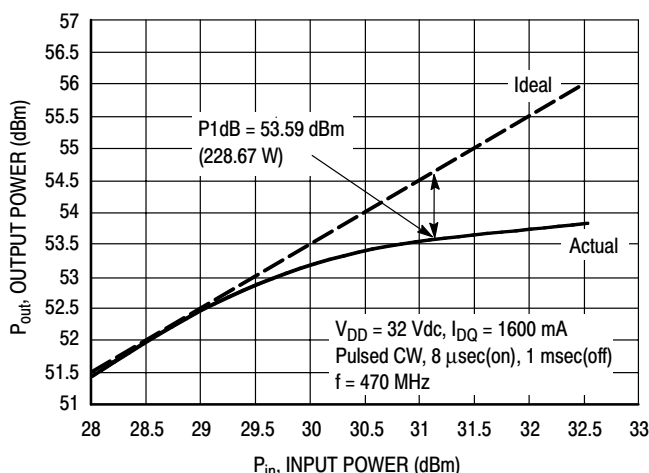

Figure 43. Pulsed CW Output Power versus Input Power @ 470 MHz

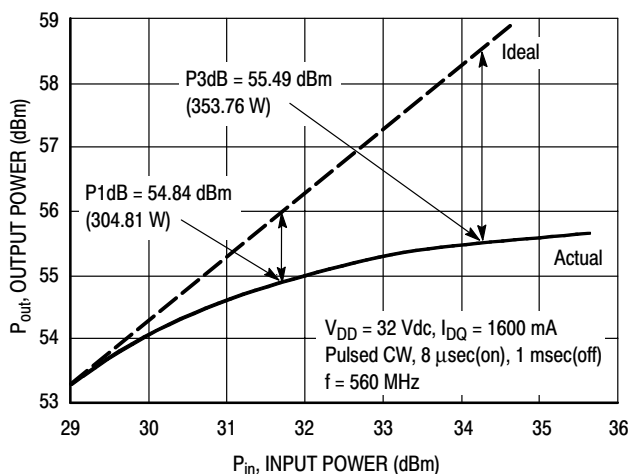

Figure 44. Pulsed CW Output Power versus Input Power @ 560 MHz

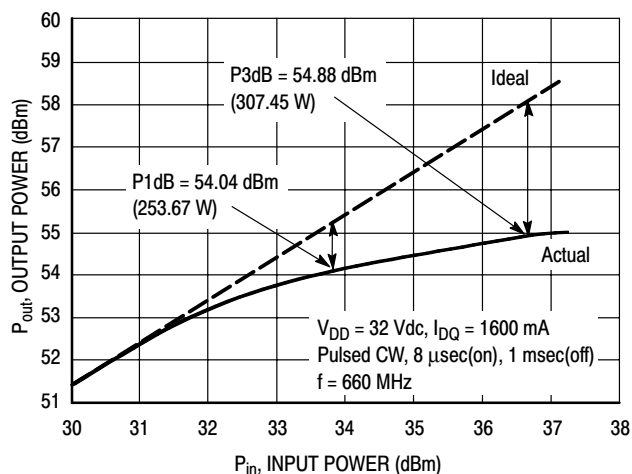

Figure 45. Pulsed CW Output Power versus Input Power @ 660 MHz

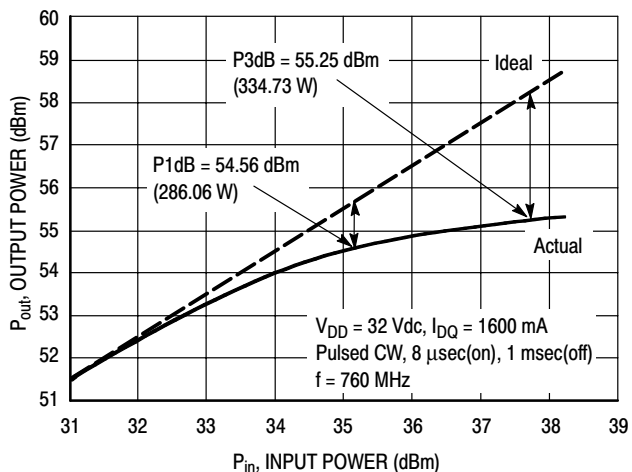

Figure 46. Pulsed CW Output Power versus Input Power @ 760 MHz

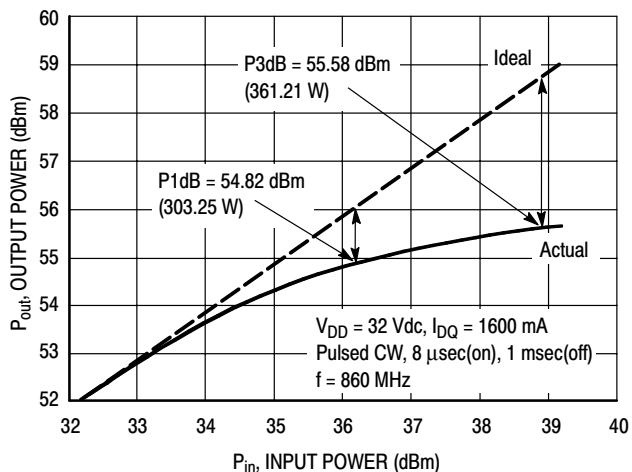

Figure 47. Pulsed CW Output Power versus Input Power @ 860 MHz

ARCHIVE INFORMATION

ARCHIVE INFORMATION

TYPICAL ATSC 8VSB BROADBAND CHARACTERISTICS

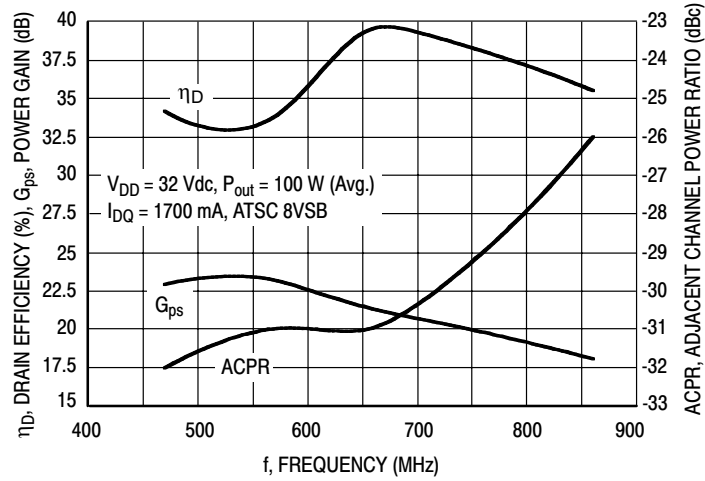

Figure 48. Single-Carrier ATSC 8VSB Broadband Performance @ 100 Watts Avg.

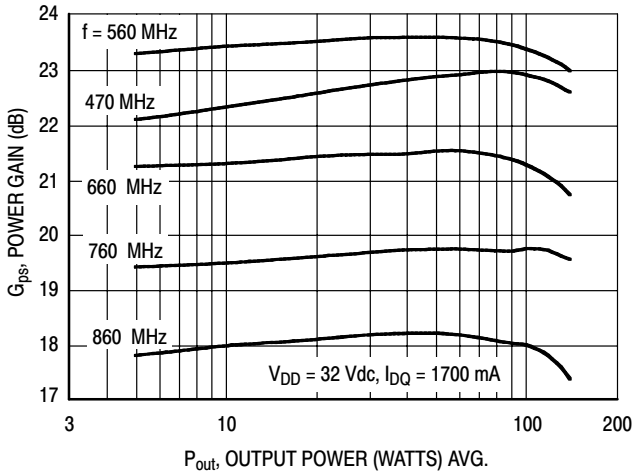

Figure 49. Single-Carrier ATSC 8VSB Power Gain versus Output Power

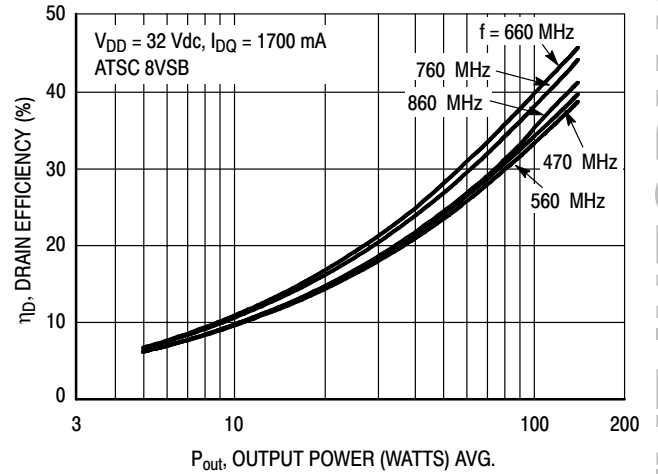

Figure 50. Single-Carrier ATSC 8VSB Drain Efficiency versus Output Power

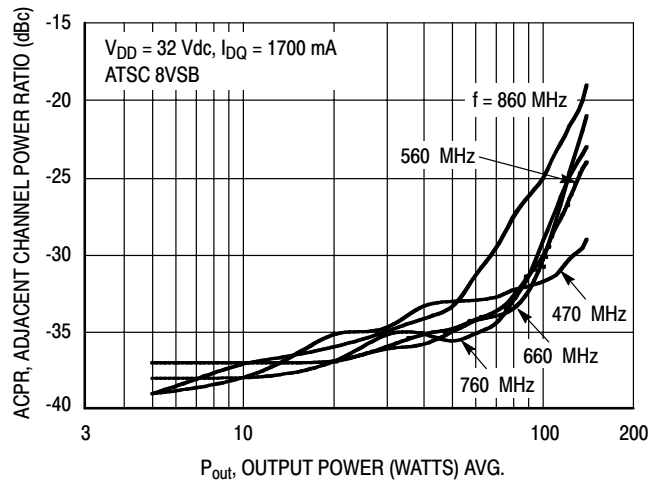

Figure 51. Single-Carrier ATSC 8VSB ACPR versus Output Power

ARCHIVE INFORMATION

ARCHIVE INFORMATION

TYPICAL PAL B/G BROADBAND CHARACTERISTICS

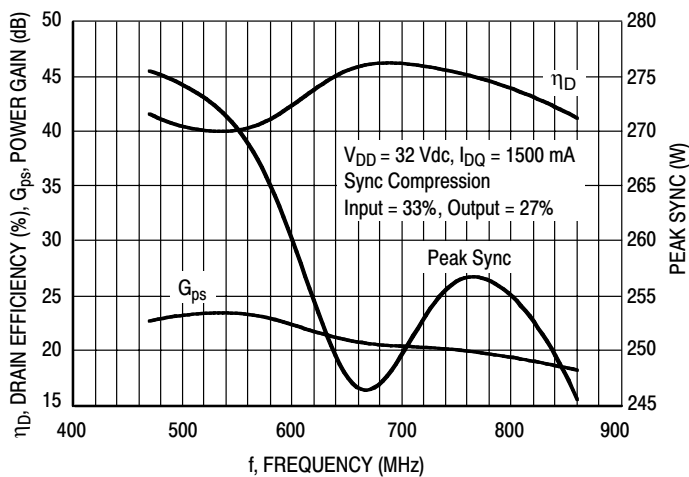
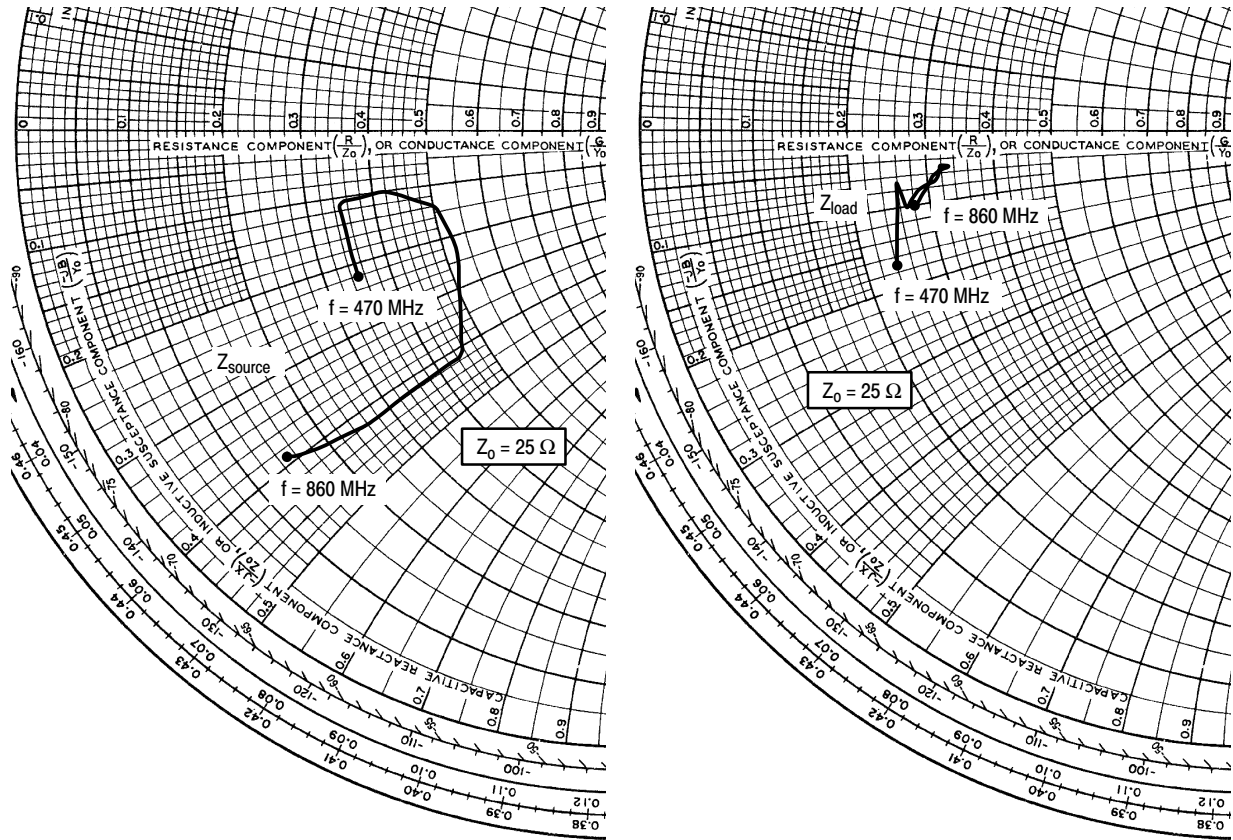

Figure 52. Peak Sync, Power Gain and Drain Efficiency versus Frequency



$V_{DD} = 32 \text{ Vdc}$, $I_{DQ} = 1600 \text{ mA}$, $P_{out} = 270 \text{ W PEP}$

f MHz	Z_{source} Ω	Z_{load} Ω
470	8.77 - j5.43	6.09 - j4.37
510	8.74 - j4.17	6.39 - j1.65
560	8.86 - j2.87	6.69 - j2.45
610	10.55 - j2.45	7.36 - j1.95
660	12.41 - j3.53	7.73 - j1.75
710	13.11 - j6.04	7.95 - j1.20
760	11.29 - j10.15	8.18 - j1.36
810	6.81 - j10.41	7.81 - j1.60
860	3.73 - j9.66	6.94 - j2.49

Z_{source} = Test circuit impedance as measured from gate to gate, balanced configuration.

Z_{load} = Test circuit impedance as measured from drain to drain, balanced configuration.

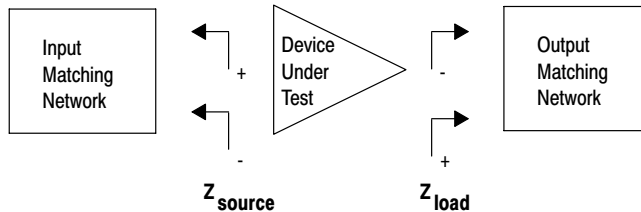
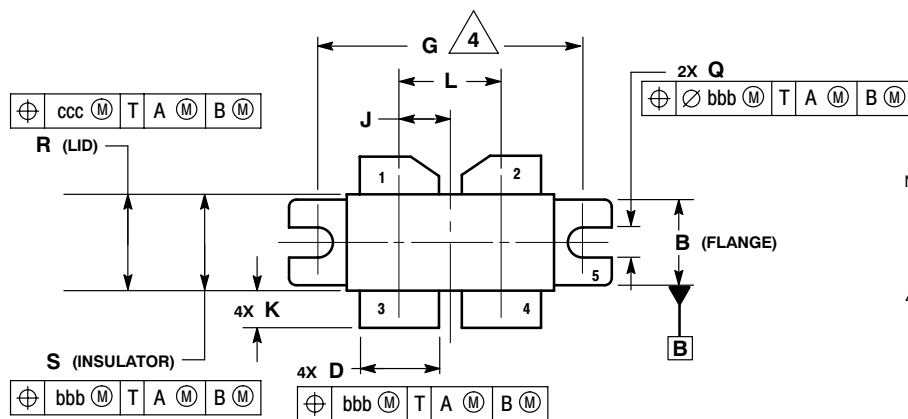

Figure 53. 470-860 MHz Broadband Series Equivalent Source and Load Impedance

PACKAGE DIMENSIONS



- NOTES:
1. CONTROLLING DIMENSION: INCH.
 2. INTERPRET DIMENSIONS AND TOLERANCES PER ASME Y14.5M-1994.
 3. DIMENSION H TO BE MEASURED 0.030 (0.762) AWAY FROM PACKAGE BODY.
 4. RECOMMENDED BOLT CENTER DIMENSION OF 1.140 (28.96) BASED ON 3M SCREW.

DIM	INCHES		MILLIMETERS	
	MIN	MAX	MIN	MAX
A	1.335	1.345	33.91	34.16
B	0.380	0.390	9.65	9.91
C	0.180	0.224	4.57	5.69
D	0.325	0.335	8.26	8.51
E	0.060	0.070	1.52	1.78
F	0.004	0.006	0.10	0.15
G	1.100 BSC		27.94 BSC	
H	0.097	0.107	2.46	2.72
J	0.2125 BSC		5.397 BSC	
K	0.135	0.165	3.43	4.19
L	0.425 BSC		10.8 BSC	
M	0.852	0.868	21.64	22.05
N	0.851	0.869	21.62	22.07
Q	0.118	0.138	3.00	3.30
R	0.395	0.405	10.03	10.29
S	0.394	0.406	10.01	10.31
bbb	0.010 REF		0.25 REF	
ccc	0.015 REF		0.38 REF	

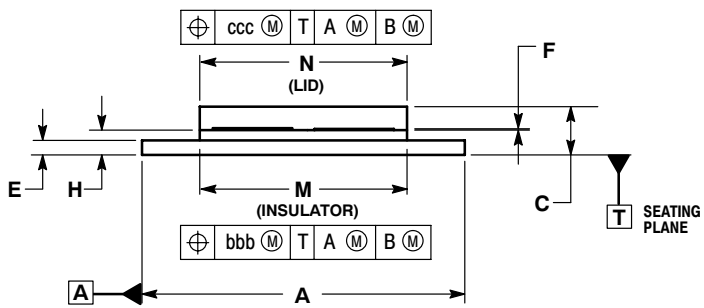

- STYLE 1:
- PIN 1. DRAIN
 - DRAIN
 - GATE
 - GATE
 - SOURCE

CASE 375G-04
ISSUE G
NI-860C3

ARCHIVE INFORMATION

ARCHIVE INFORMATION

PRODUCT DOCUMENTATION

Refer to the following documents to aid your design process.

Application Notes

- AN1955: Thermal Measurement Methodology of RF Power Amplifiers

Engineering Bulletins

- EB212: Using Data Sheet Impedances for RF LDMOS Devices

REVISION HISTORY

The following table summarizes revisions to this document.

Revision	Date	Description
2	Oct. 2008	<ul style="list-style-type: none"> • Listed replacement part and Device Migration notification reference number, p. 1 • Removed Lower Thermal Resistance and Low Gold Plating bullets from Features section as functionality is standard, p. 1 • Removed Total Device Dissipation from Max Ratings table as data was redundant (information already provided in Thermal Characteristics table), p. 1 • Operating Junction Temperature increased from 200°C to 225°C in Maximum Ratings table and related “Continuous use at maximum temperature will affect MTTF” footnote added, p. 1 • Corrected V_{DS} to V_{DD} in the RF test condition voltage callout for $V_{GS(Q)}$, On Characteristics table, p. 2 • Removed Forward Transconductance from On Characteristics table as it no longer provided usable information, p. 2 • Corrected Z list in Figs. 1, 19, Test Circuit Schematic, p. 3, 10 • Updated PCB information to show more specific material details, Figs. 1, 19, Test Circuit Schematic, p. 3, 10 • Updated Part Numbers in Tables 5, 6, Component Designations and Values, to latest RoHS compliant part numbers, p. 3, 11 • Removed lower voltage tests from Fig. 12, Power Gain versus Output Power, due to fixed tuned fixture limitations, p. 7 • Replaced Fig. 13, MTTF versus Junction Temperature with updated graph. Removed Amps² and listed operating characteristics and location of MTTF calculator for device, p. 7 • Adjusted scale for Figs. 22-26, Two-Tone Power Gain versus Output Power, and Figs. 27-31, Third Order Intermodulation Distortion versus Output Power, to show wider dynamic range, p. 13, 14 • Added Product Documentation and Revision History, p. 23

ARCHIVE INFORMATION

ARCHIVE INFORMATION

How to Reach Us:**Home Page:**

www.freescale.com

Web Support:

<http://www.freescale.com/support>

USA/Europe or Locations Not Listed:

Freescale Semiconductor, Inc.
Technical Information Center, EL516
2100 East Elliot Road
Tempe, Arizona 85284
1-800-521-6274 or +1-480-768-2130
www.freescale.com/support

Europe, Middle East, and Africa:

Freescale Halbleiter Deutschland GmbH
Technical Information Center
Schatzbogen 7
81829 Muenchen, Germany
+44 1296 380 456 (English)
+46 8 52200080 (English)
+49 89 92103 559 (German)
+33 1 69 35 48 48 (French)
www.freescale.com/support

Japan:

Freescale Semiconductor Japan Ltd.
Headquarters
ARCO Tower 15F
1-8-1, Shimo-Meguro, Meguro-ku,
Tokyo 153-0064
Japan
0120 191014 or +81 3 5437 9125
support.japan@freescale.com

Asia/Pacific:

Freescale Semiconductor China Ltd.
Exchange Building 23F
No. 118 Jianguo Road
Chaoyang District
Beijing 100022
China
+86 10 5879 8000
support.asia@freescale.com

For Literature Requests Only:

Freescale Semiconductor Literature Distribution Center
P.O. Box 5405
Denver, Colorado 80217
1-800-441-2447 or +1-303-675-2140
Fax: +1-303-675-2150
LDCForFreescaleSemiconductor@hibbertgroup.com

Information in this document is provided solely to enable system and software implementers to use Freescale Semiconductor products. There are no express or implied copyright licenses granted hereunder to design or fabricate any integrated circuits or integrated circuits based on the information in this document.

Freescale Semiconductor reserves the right to make changes without further notice to any products herein. Freescale Semiconductor makes no warranty, representation or guarantee regarding the suitability of its products for any particular purpose, nor does Freescale Semiconductor assume any liability arising out of the application or use of any product or circuit, and specifically disclaims any and all liability, including without limitation consequential or incidental damages. "Typical" parameters that may be provided in Freescale Semiconductor data sheets and/or specifications can and do vary in different applications and actual performance may vary over time. All operating parameters, including "Typicals", must be validated for each customer application by customer's technical experts. Freescale Semiconductor does not convey any license under its patent rights nor the rights of others. Freescale Semiconductor products are not designed, intended, or authorized for use as components in systems intended for surgical implant into the body, or other applications intended to support or sustain life, or for any other application in which the failure of the Freescale Semiconductor product could create a situation where personal injury or death may occur. Should Buyer purchase or use Freescale Semiconductor products for any such unintended or unauthorized application, Buyer shall indemnify and hold Freescale Semiconductor and its officers, employees, subsidiaries, affiliates, and distributors harmless against all claims, costs, damages, and expenses, and reasonable attorney fees arising out of, directly or indirectly, any claim of personal injury or death associated with such unintended or unauthorized use, even if such claim alleges that Freescale Semiconductor was negligent regarding the design or manufacture of the part.

Freescale™ and the Freescale logo are trademarks of Freescale Semiconductor, Inc. All other product or service names are the property of their respective owners.

© Freescale Semiconductor, Inc. 2005-2006, 2008. All rights reserved.

Looking for pricing, stock, or lifecycle information?

Click below to explore more details on WIN SOURCE:

- ⊖ [View MRF6P3300HR5 on WIN SOURCE](#)
- ⊖ [Freescale Semiconductor - NXP Information](#)

Optimize Your Supply Chain with WIN SOURCE Solutions

- ✓ Global Sourcing Solution
- ✓ Obsolete Management
- ✓ Cost Control Management
- ✓ Shortage Management
- ✓ Alternative Solution
- ✓ Excess Inventory Management