



**THE DATASHEET OF  
MRF6VP3450HR5**



# RF Power Field Effect Transistors

## N-Channel Enhancement-Mode Lateral MOSFETs

Designed for broadband commercial and industrial applications with frequencies from 470 to 860 MHz. The high gain and broadband performance of these devices make them ideal for large-signal, common-source amplifier applications in 50 volt analog or digital television transmitter equipment.

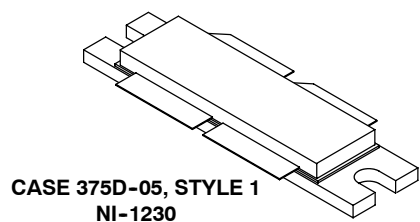
- Typical DVB-T OFDM Performance:  $V_{DD} = 50$  Volts,  $I_{DQ} = 1400$  mA,  $P_{out} = 90$  Watts Avg.,  $f = 860$  MHz, 8K Mode, 64 QAM  
 Power Gain — 22.5 dB  
 Drain Efficiency — 28%  
 ACPR @ 4 MHz Offset — -62 dBc @ 4 kHz Bandwidth
- Typical Broadband Two-Tone Performance:  $V_{DD} = 50$  Volts,  $I_{DQ} = 1400$  mA,  $P_{out} = 450$  Watts PEP,  $f = 470$ -860 MHz  
 Power Gain — 22 dB  
 Drain Efficiency — 44%  
 IM3 — -29 dBc
- Capable of Handling 10:1 VSWR, All Phase Angles, @ 50 Vdc, 860 MHz:  
 450 Watts CW  
 90 Watts Avg. (DVB-T OFDM Signal, 10 dB PAR, 7.61 MHz Channel Bandwidth)

### Features

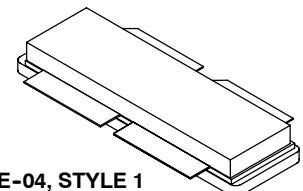
- Characterized with Series Equivalent Large-Signal Impedance Parameters
- Internally Input Matched for Ease of Use
- Qualified Up to a Maximum of 50  $V_{DD}$  Operation
- Integrated ESD Protection
- Designed for Push-Pull Operation
- Greater Negative Gate-Source Voltage Range for Improved Class C Operation
- RoHS Compliant
- In Tape and Reel. R6 Suffix = 150 Units per 56 mm, 13 inch Reel.  
 R5 Suffix = 50 Units per 56 mm, 13 inch Reel.

**MRF6VP3450HR6**  
**MRF6VP3450HR5**  
**MRF6VP3450HSR6**  
**MRF6VP3450HSR5**

**860 MHz, 450 W, 50 V**  
**LATERAL N-CHANNEL**  
**BROADBAND**  
**RF POWER MOSFETs**

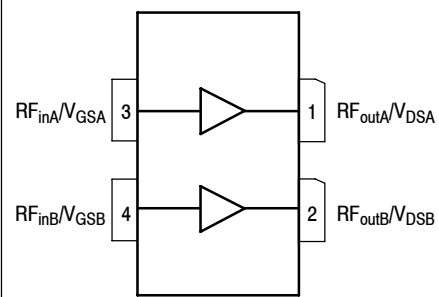


**CASE 375D-05, STYLE 1**  
**NI-1230**  
**MRF6VP3450HR6(HR5)**



**CASE 375E-04, STYLE 1**  
**NI-1230S**  
**MRF6VP3450HSR6(HSR5)**

**PARTS ARE PUSH-PULL**



(Top View)

**Figure 1. Pin Connections**

**Table 1. Maximum Ratings**

Rating	Symbol	Value	Unit
Drain-Source Voltage	$V_{DSS}$	-0.5, +110	Vdc
Gate-Source Voltage	$V_{GS}$	-6.0, +10	Vdc
Storage Temperature Range	$T_{stg}$	- 65 to +150	°C
Case Operating Temperature	$T_C$	150	°C
Operating Junction Temperature (1,2)	$T_J$	225	°C

1. Continuous use at maximum temperature will affect MTTF.  
 2. MTTF calculator available at <http://www.freescale.com/rf>. Select Software & Tools/Development Tools/Calculators to access MTTF calculators by product.

**Table 2. Thermal Characteristics**

Characteristic	Symbol	Value (1,2)	Unit
Thermal Resistance, Junction to Case	R <sub>θJC</sub>	0.27	°C/W
Case Temperature 80°C, 90 W CW		0.25	
Case Temperature 44°C, 450 W CW	Z <sub>θJC</sub>	0.04	

**Table 3. ESD Protection Characteristics**

Test Methodology	Class
Human Body Model (per JESD22-A114)	1B (Minimum)
Machine Model (per EIA/JESD22-A115)	B (Minimum)
Charge Device Model (per JESD22-C101)	IV (Minimum)

**Table 4. Electrical Characteristics** (T<sub>A</sub> = 25°C unless otherwise noted)

Characteristic	Symbol	Min	Typ	Max	Unit
----------------	--------	-----	-----	-----	------

**Off Characteristics (3)**

Gate-Source Leakage Current (V <sub>GS</sub> = 5 Vdc, V <sub>DS</sub> = 0 Vdc)	I <sub>GSS</sub>	—	—	10	μAdc
Drain-Source Breakdown Voltage (I <sub>D</sub> = 50 mA, V <sub>GS</sub> = 0 Vdc)	V <sub>(BR)DSS</sub>	110	—	—	Vdc
Zero Gate Voltage Drain Leakage Current (V <sub>DS</sub> = 50 Vdc, V <sub>GS</sub> = 0 Vdc)	I <sub>DSS</sub>	—	—	10	μAdc
Zero Gate Voltage Drain Leakage Current (V <sub>DS</sub> = 100 Vdc, V <sub>GS</sub> = 0 Vdc)	I <sub>DSS</sub>	—	—	10	μAdc

**On Characteristics**

Gate Threshold Voltage (3) (V <sub>DS</sub> = 10 Vdc, I <sub>D</sub> = 320 μAdc)	V <sub>GS(th)</sub>	1	1.6	2.5	Vdc
Gate Quiescent Voltage (4) (V <sub>DD</sub> = 50 Vdc, I <sub>D</sub> = 1400 mAdc, Measured in Functional Test)	V <sub>GS(Q)</sub>	2	2.6	3.5	Vdc
Drain-Source On-Voltage (3) (V <sub>GS</sub> = 10 Vdc, I <sub>D</sub> = 1.58 Adc)	V <sub>DS(on)</sub>	—	0.25	—	Vdc

**Dynamic Characteristics (3,5)**

Reverse Transfer Capacitance (V <sub>DS</sub> = 50 Vdc ± 30 mV(rms)ac @ 1 MHz, V <sub>GS</sub> = 0 Vdc)	C <sub>rSS</sub>	—	0.92	—	pF
Output Capacitance (V <sub>DS</sub> = 50 Vdc ± 30 mV(rms)ac @ 1 MHz, V <sub>GS</sub> = 0 Vdc)	C <sub>oss</sub>	—	54.5	—	pF
Input Capacitance (V <sub>DS</sub> = 50 Vdc, V <sub>GS</sub> = 0 Vdc ± 30 mV(rms)ac @ 1 MHz)	C <sub>iss</sub>	—	373	—	pF

**Functional Tests (4)** (In Freescale Broadband Test Fixture, 50 ohm system) V<sub>DD</sub> = 50 Vdc, I<sub>DQ</sub> = 1400 mA, P<sub>out</sub> = 90 W Avg., f = 860 MHz, DVB-T OFDM Single Channel. ACPR measured in 7.61 MHz Channel Bandwidth @ ±4 MHz Offset @ 4 kHz Bandwidth.

Power Gain	G <sub>ps</sub>	21.5	22.5	24.5	dB
Drain Efficiency	η <sub>D</sub>	26	28	—	%
Adjacent Channel Power Ratio	ACPR	—	-62	-59	dBc
Input Return Loss	IRL	—	-4	-2	dB

1. MTTF calculator available at <http://www.freescale.com/rf>. Select Software & Tools/Development Tools/Calculators to access MTTF calculators by product.
2. Refer to AN1955, *Thermal Measurement Methodology of RF Power Amplifiers*. Go to <http://www.freescale.com/rf>. Select Documentation/Application Notes - AN1955.
3. Each side of device measured separately.
4. Measurement made with device in push-pull configuration.
5. Part internally input matched.

(continued)

**Table 4. Electrical Characteristics** ( $T_A = 25^\circ\text{C}$  unless otherwise noted) (continued)

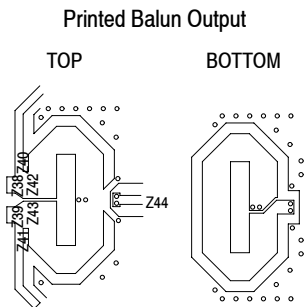
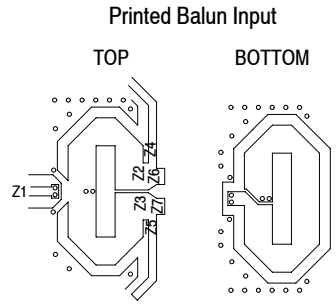
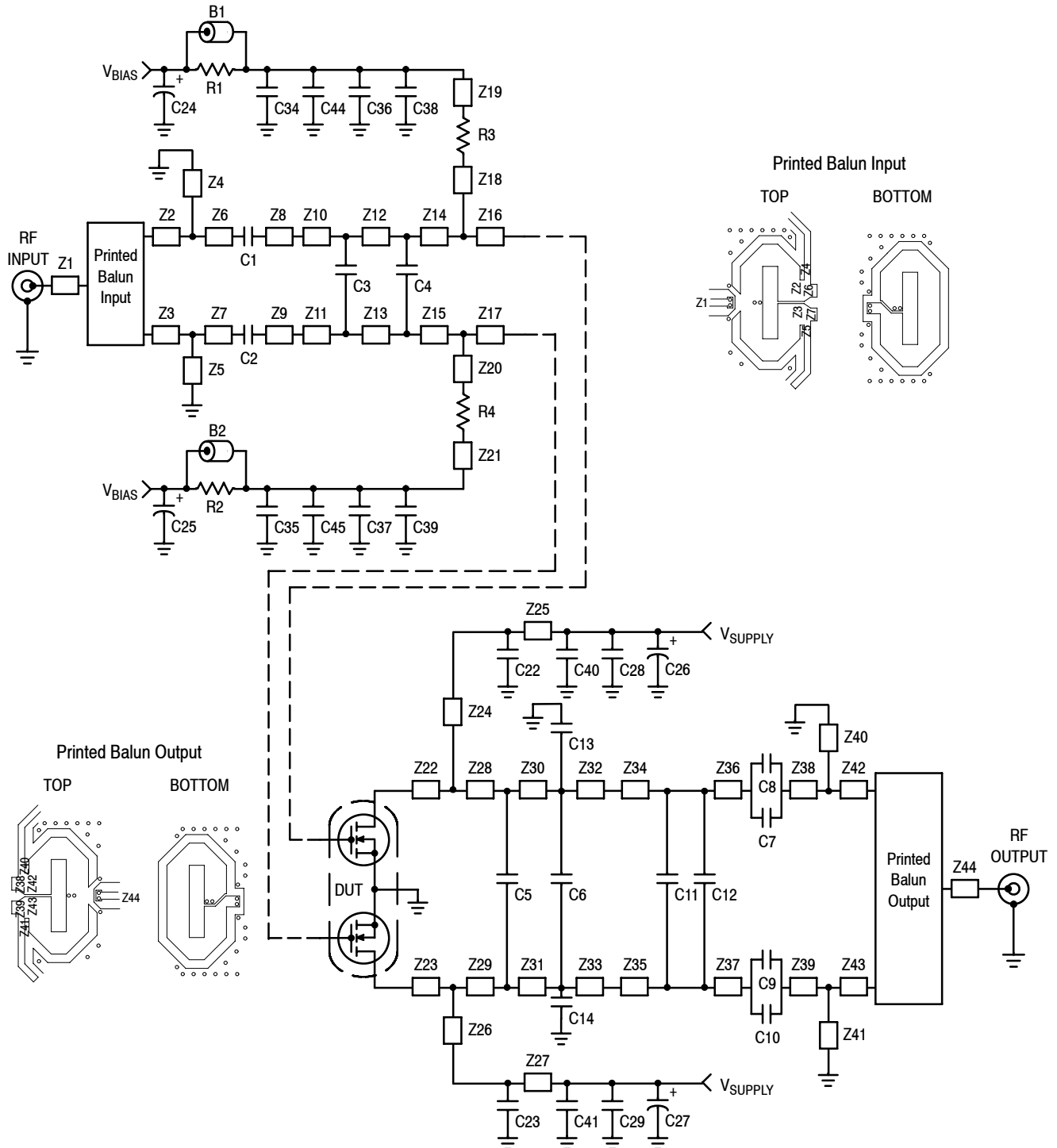
Characteristic	Symbol	Min	Typ	Max	Unit
----------------	--------	-----	-----	-----	------

**Typical Pulsed Performances** (In Freescale Broadband Test Fixture, 50 ohm system)  $V_{DD} = 50\text{ Vdc}$ ,  $I_{DQ} = 1200\text{ mA}$ ,  $P_{out} = 520\text{ W}$ ,  $f = 470\text{--}860\text{ MHz}$ , 50  $\mu\text{sec}$  Pulse Width, 2.5% Duty Cycle

Power Gain	$G_{ps}$	—	20.5	—	dB
Drain Efficiency	$\eta_D$	—	50	—	%
Input Return Loss	IRL	—	-3	—	dB
$P_{out}$ @ 1 dB Compression Point, Pulsed CW ( $f = 470\text{--}860\text{ MHz}$ )	P1dB	—	520	—	W

**Typical Two-Tone Performances** (In Freescale Broadband Test Fixture, 50 ohm system)  $V_{DD} = 50\text{ Vdc}$ ,  $I_{DQ} = 1400\text{ mA}$ ,  $P_{out} = 450\text{ W PEP}$ ,  $f = 470\text{--}860\text{ MHz}$ , 100 kHz Tone Spacing

Power Gain	$G_{ps}$	—	22	—	dB
Drain Efficiency	$\eta_D$	—	44	—	%
Intermodulation Distortion	IM3	—	-29	—	dBc
Input Return Loss	IRL	—	-2	—	dB



Z1	0.343" x 0.065" Microstrip	Z16, Z17	0.172" x 0.465" Microstrip	Z32, Z33	0.108" x 0.392" Microstrip
Z2, Z3	0.039" x 0.200" Microstrip	Z18, Z20	0.397" x 0.059" Microstrip	Z34, Z35	0.212" x 0.388" Microstrip
Z4, Z5	1.400" x 0.059" Microstrip	Z19, Z21	0.800" x 0.059" Microstrip	Z36, Z37	0.103" x 0.388" Microstrip
Z6, Z7	0.059" x 0.118" Microstrip	Z22, Z23	0.276" x 0.465" Microstrip	Z38, Z39	0.075" x 0.157" Microstrip
Z8, Z9	0.059" x 0.118" Microstrip	Z24, Z26	0.070" x 0.157" Microstrip	Z40, Z41	1.412" x 0.071" Microstrip
Z10, Z11	0.150" x 0.394" Microstrip	Z25, Z27	1.000" x 0.157" Microstrip	Z42, Z43	0.024" x 0.087" Microstrip
Z12, Z13	0.359" x 0.394" Microstrip	Z28, Z29	0.103" x 0.392" Microstrip	Z44	0.550" x 0.065" Microstrip
Z14, Z15	0.308" x 0.394" Microstrip	Z30, Z31	0.084" x 0.392" Microstrip	PCB	Taconic RF35, 0.031", $\epsilon_r = 3.5$

Figure 2. MRF6VP3450HR6(HSR6) Test Circuit Schematic

**Table 5. MRF6VP3450HR6(HSR6) Test Circuit Component Designations and Values**

Part	Description	Part Number	Manufacturer
B1, B2	Short Ferrite Beads	2743019447	Fair-Rite
C1, C2	12 pF Chip Capacitors	ATC100B120GT500XT	ATC
C3	6.8 pF Chip Capacitor	ATC100B6R8BT500XT	ATC
C4	10 pF Chip Capacitor	ATC100B100GT500XT	ATC
C5, C6, C8, C9	6.8 pF Chip Capacitors	ATC800B6R8BT500XT	ATC
C7, C10, C13, C14	10 pF Chip Capacitors	ATC800B100J500XT	ATC
C11	4.7 pF Chip Capacitor	ATC800B4R7J500XT	ATC
C12	3.9 pF Chip Capacitor	ATC800B3R9J500XT	ATC
C22, C23	330 pF Chip Capacitors	ATC100B331GT500XT	ATC
C24, C25	22 $\mu$ F Electrolytic Capacitors	UUD1V220MCL1GS	Nichicon
C26, C27	220 $\mu$ F, 100 V Electrolytic Capacitors	EEVFK2A221M	Panasonic
C28, C29	10 $\mu$ F, 50 V Chip Capacitors	C5750X5R1H106MT	TDK
C34, C35	39 nF Chip Capacitors	ATC200B393KT50XT	ATC
C36, C37	1000 pF Chip Capacitors	ATC100B102JT500XT	ATC
C38, C39	470 pF Chip Capacitors	ATC100B471JT500XT	ATC
C40, C41	2.2 $\mu$ F, 100 V Chip Capacitors	HMK432BJ225KM-T	Taiyo Yuden
C44, C45	2.2 $\mu$ F, 50 V Chip Capacitors	C3225X7R1H225MT	TDK
R1, R2	10 $\Omega$ , 1/8 W Chip Resistors	CRCW120610R0FKEA	Vishay
R3, R4	1.5 $\Omega$ , 1/8 W Chip Resistors	CRCW12061R50FKEA	Vishay

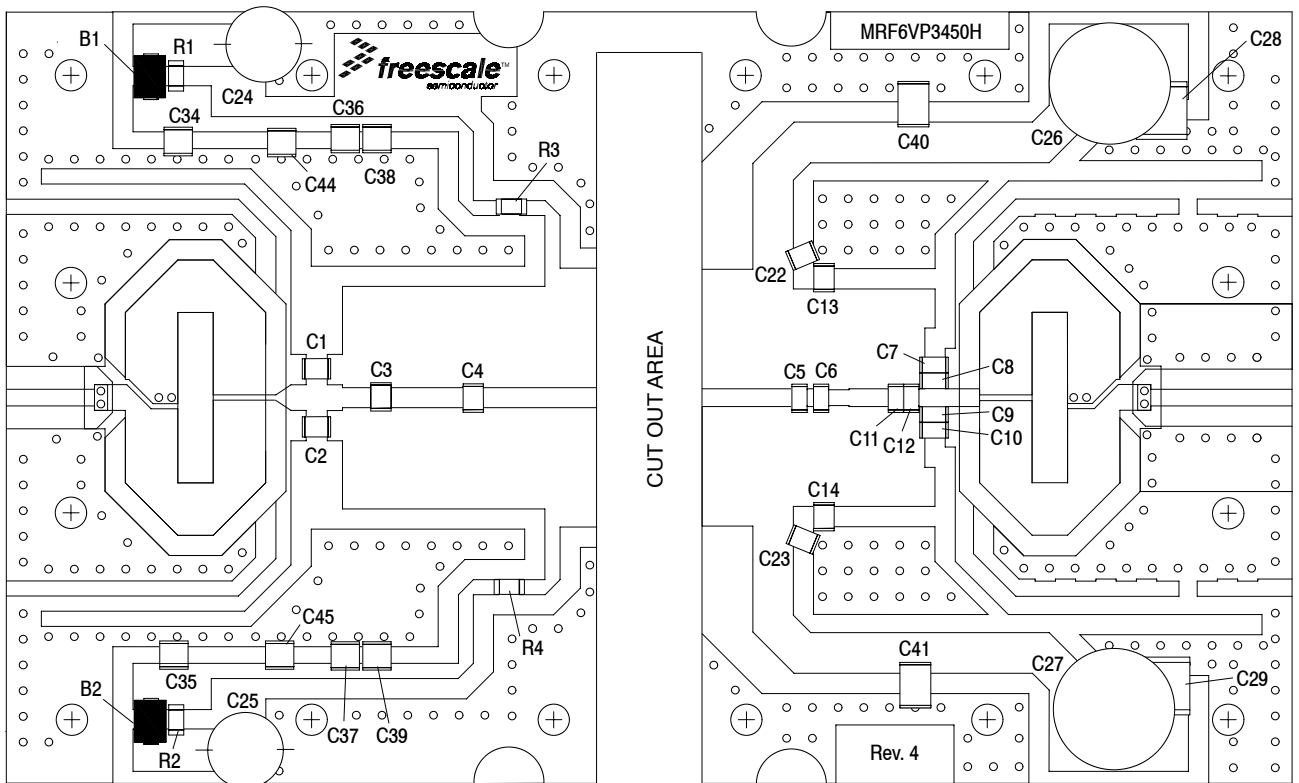


Figure 3. MRF6VP3450HR6(HSR6) Test Circuit Component Layout — Top

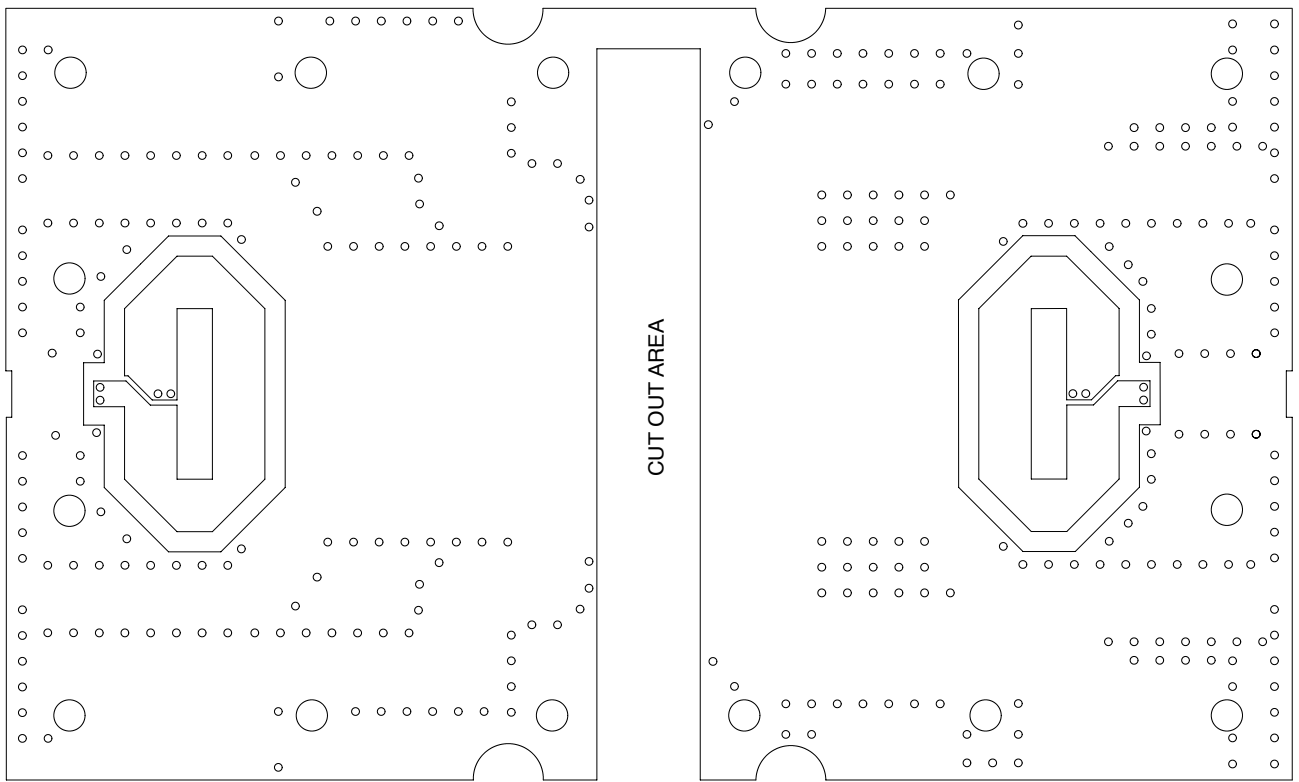
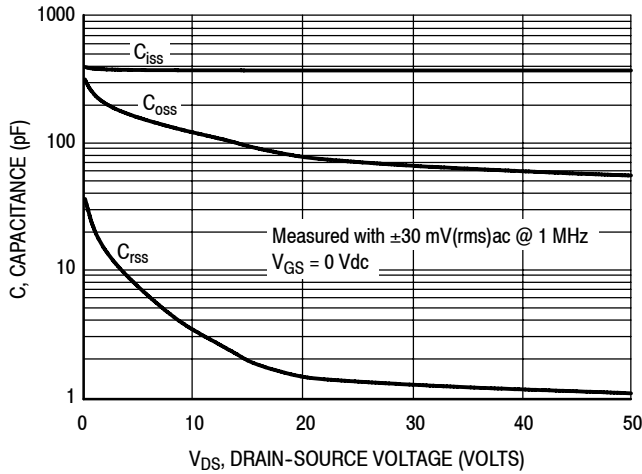


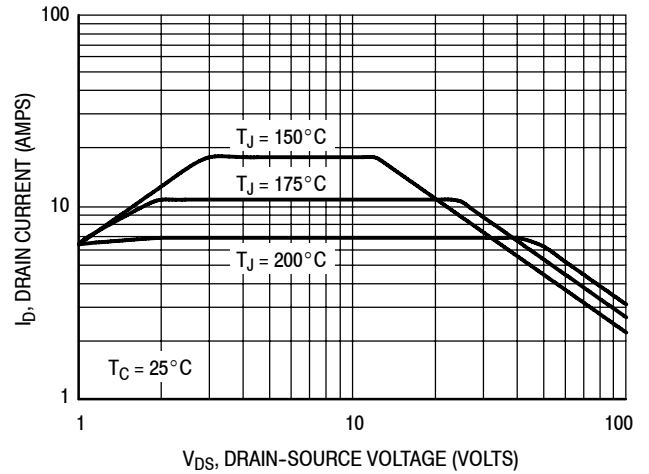
Figure 3a. MRF6VP3450HR6(HSR6) Test Circuit Component Layout — Bottom

## TYPICAL CHARACTERISTICS



Note: Each side of device measured separately.

Figure 4. Capacitance versus Drain-Source Voltage



Note: Each side of device measured separately.

Figure 5. DC Safe Operating Area

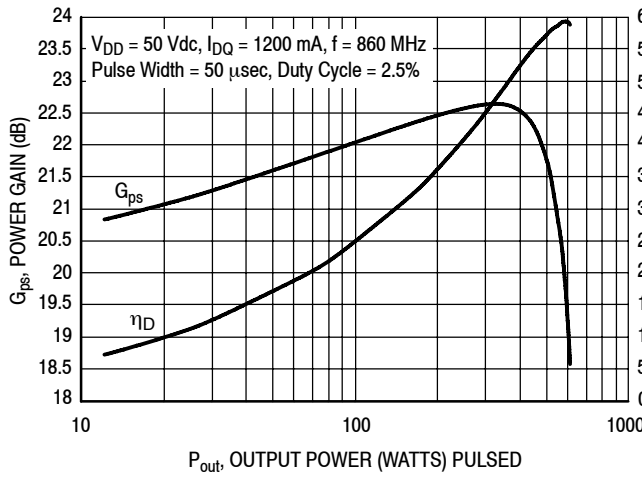


Figure 6. Pulsed Power Gain and Drain Efficiency versus Output Power

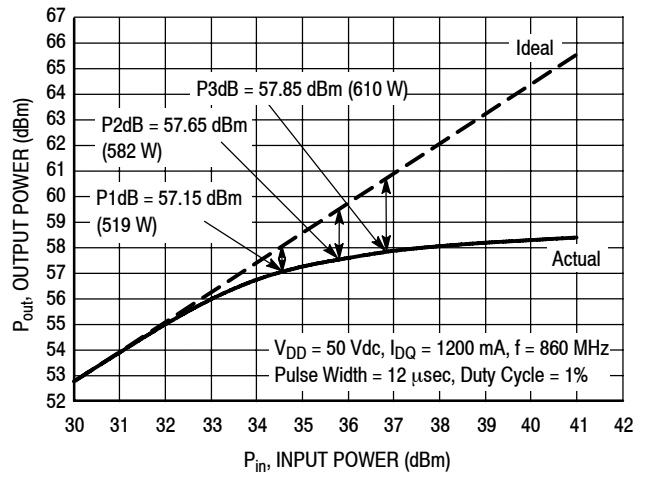


Figure 7. Pulsed CW Output Power versus Input Power

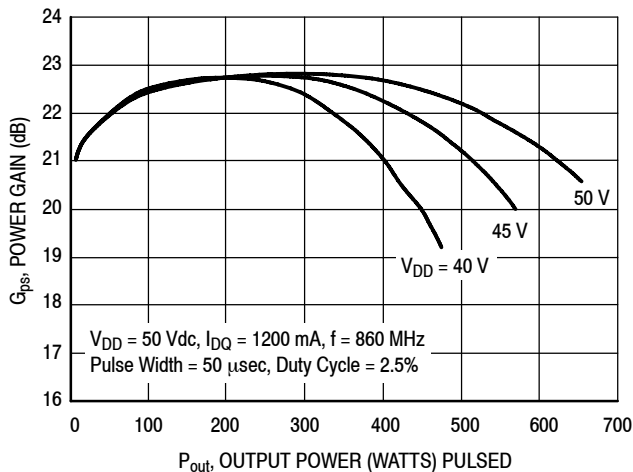


Figure 8. Pulsed Power Gain versus Output Power

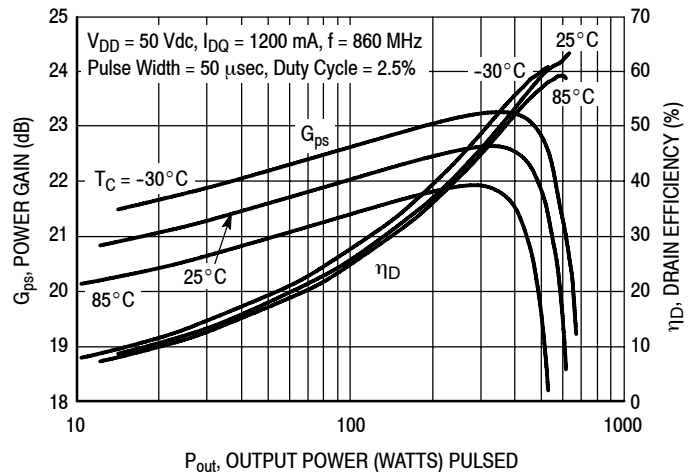
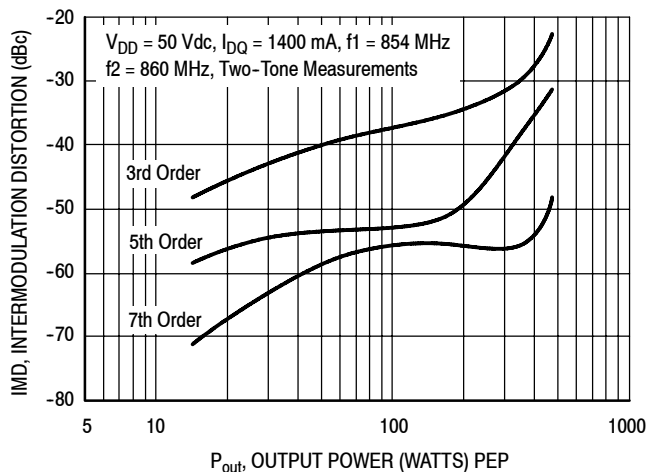
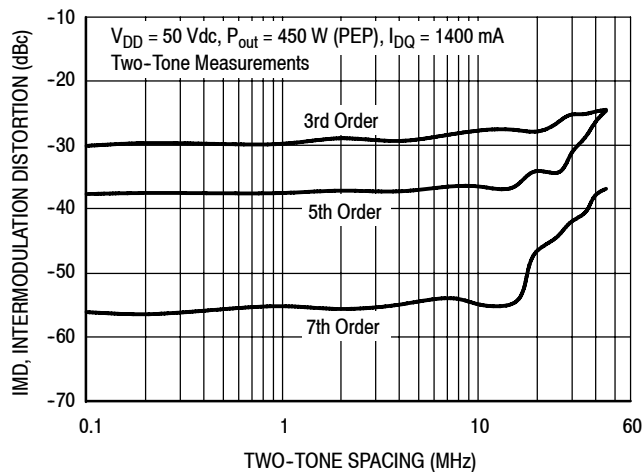


Figure 9. Pulsed Power Gain and Drain Efficiency versus Output Power

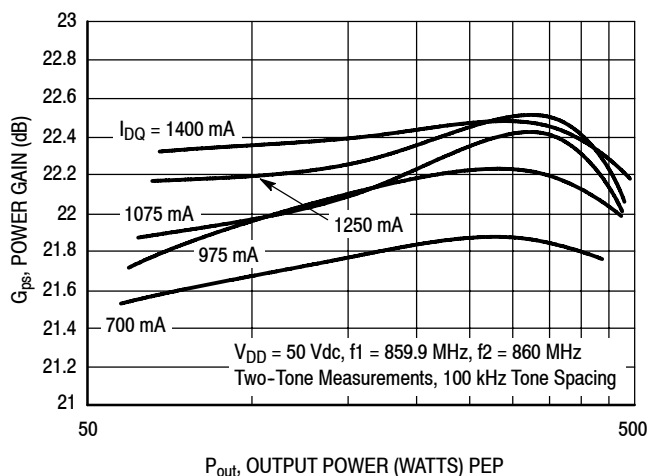
### TYPICAL CHARACTERISTICS — TWO-TONE



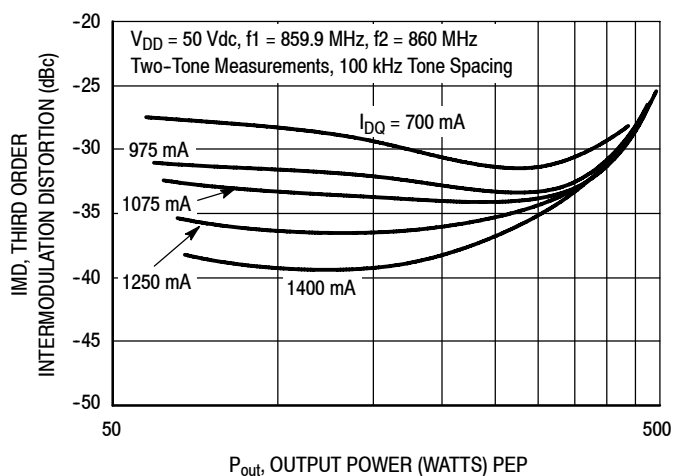
**Figure 10. Intermodulation Distortion Products versus Output Power**



**Figure 11. Intermodulation Distortion Products versus Tone Spacing**



**Figure 12. Two-Tone Power Gain versus Output Power**



**Figure 13. Third Order Intermodulation Distortion versus Output Power**

## TYPICAL CHARACTERISTICS — OFDM

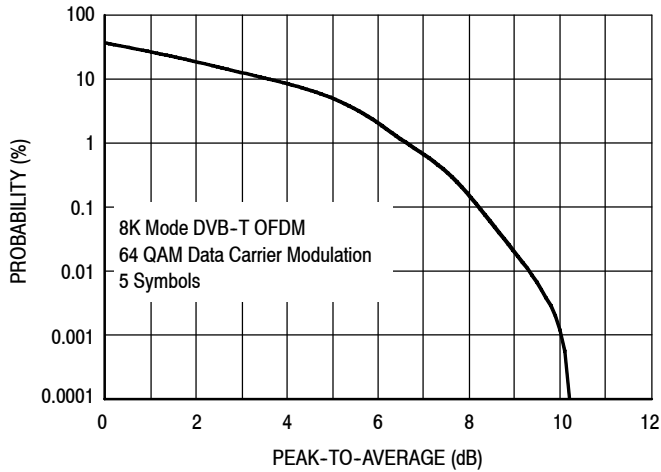


Figure 14. Single-Carrier DVB-T OFDM

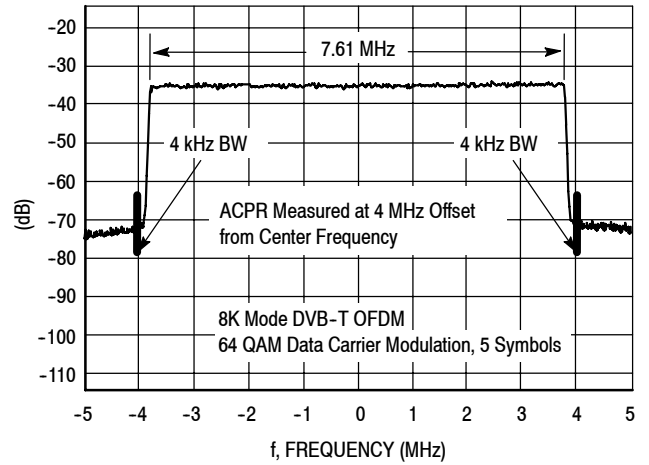


Figure 15. 8K Mode DVB-T OFDM Spectrum

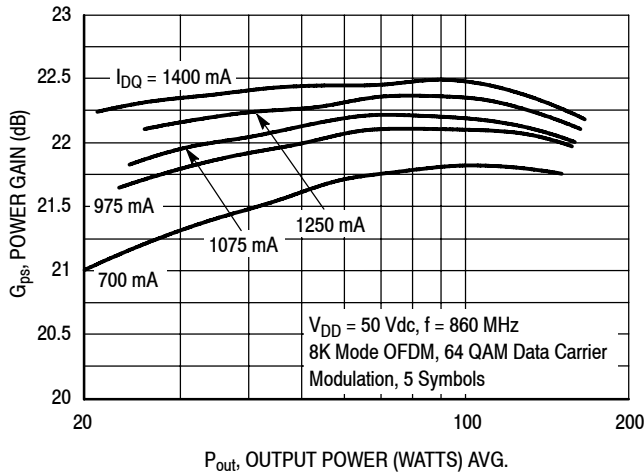


Figure 16. Single-Carrier DVB-T OFDM Power Gain versus Output Power

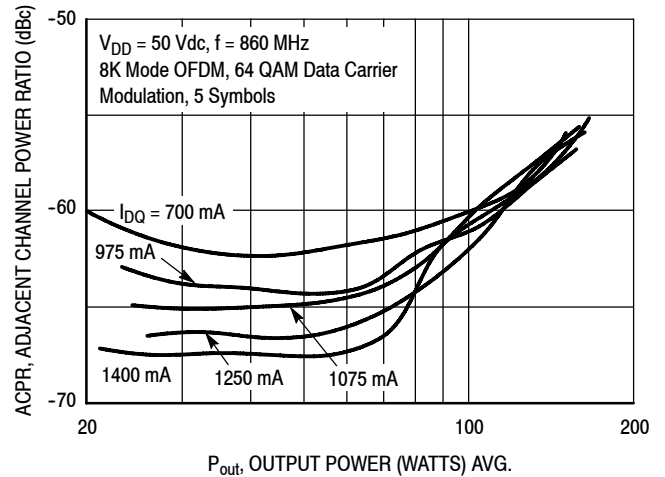


Figure 17. Single-Carrier DVB-T OFDM ACPR versus Output Power

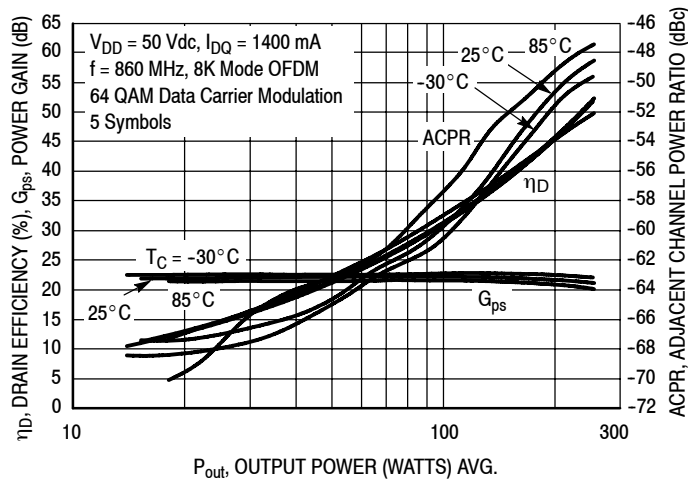
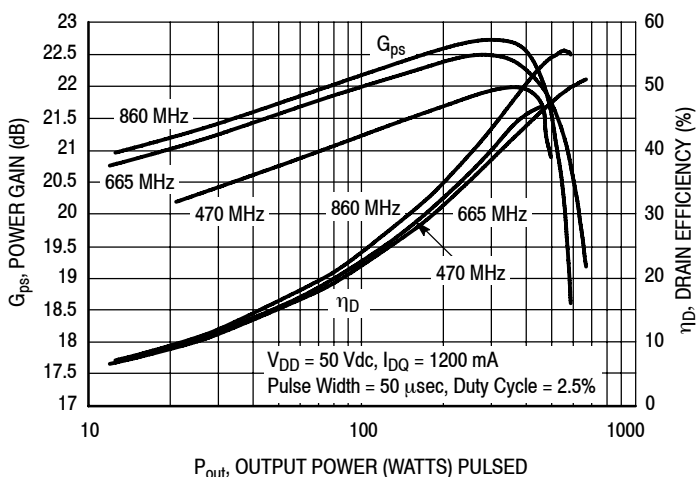
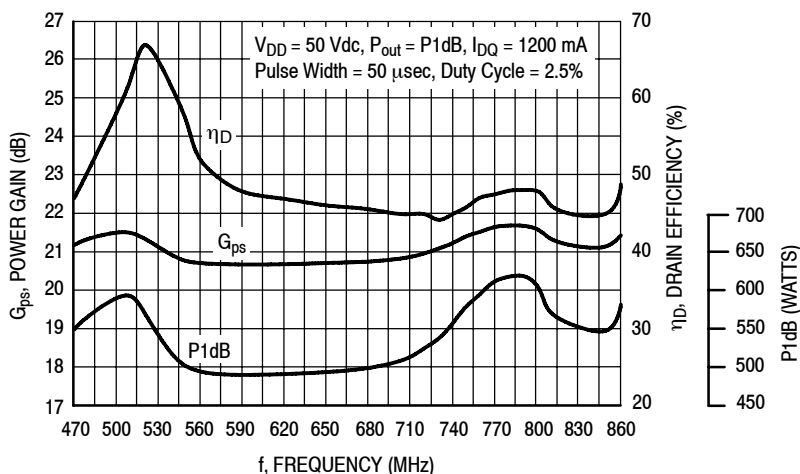


Figure 18. Single-Carrier DVB-T OFDM ACPR Power Gain and Drain Efficiency versus Output Power

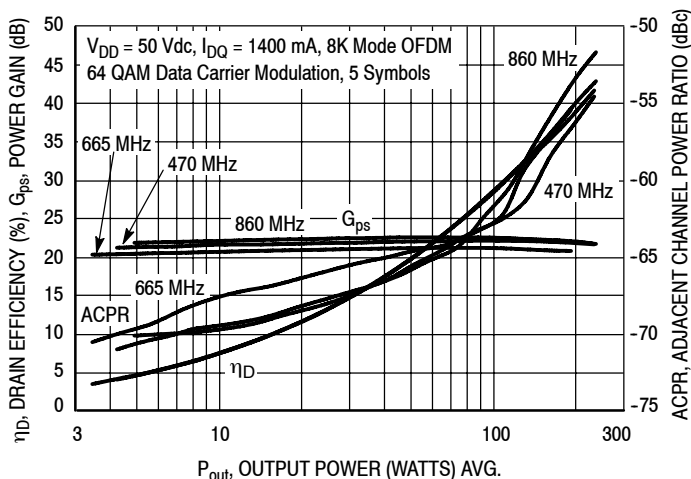
### TYPICAL CHARACTERISTICS — 470-860 MHz



**Figure 19. Broadband Pulsed Power Gain and Drain Efficiency versus Output Power — 470-860 MHz**

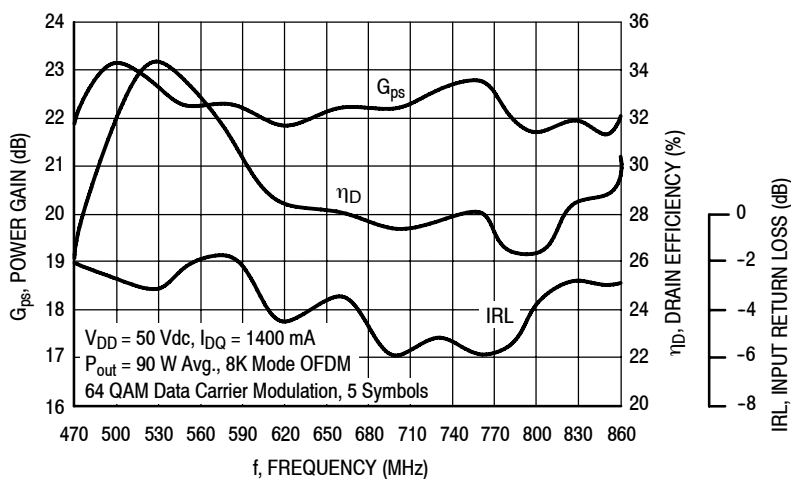


**Figure 20. Pulsed Power Gain and Drain Efficiency versus Frequency at P1dB — 470-860 MHz**



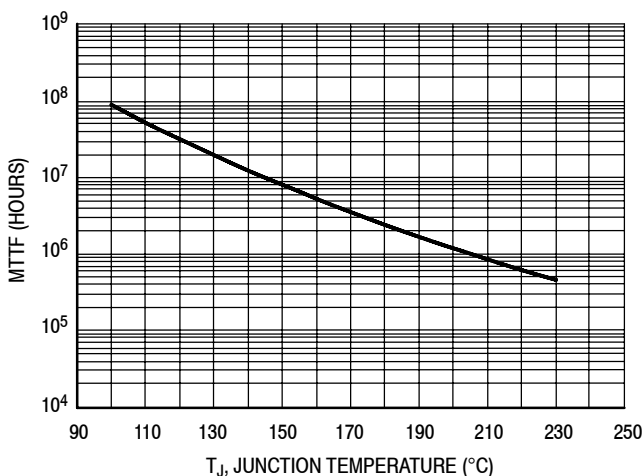
**Figure 21. Single-Carrier DVB-T OFDM ACPR, Power Gain and Drain Efficiency versus Output Power — 470-860 MHz**

### TYPICAL CHARACTERISTICS — 470-860 MHz



**Figure 22. Single-Carrier DVB-T OFDM Power Gain, Drain Efficiency and IRL versus Frequency — 470-860 MHz**

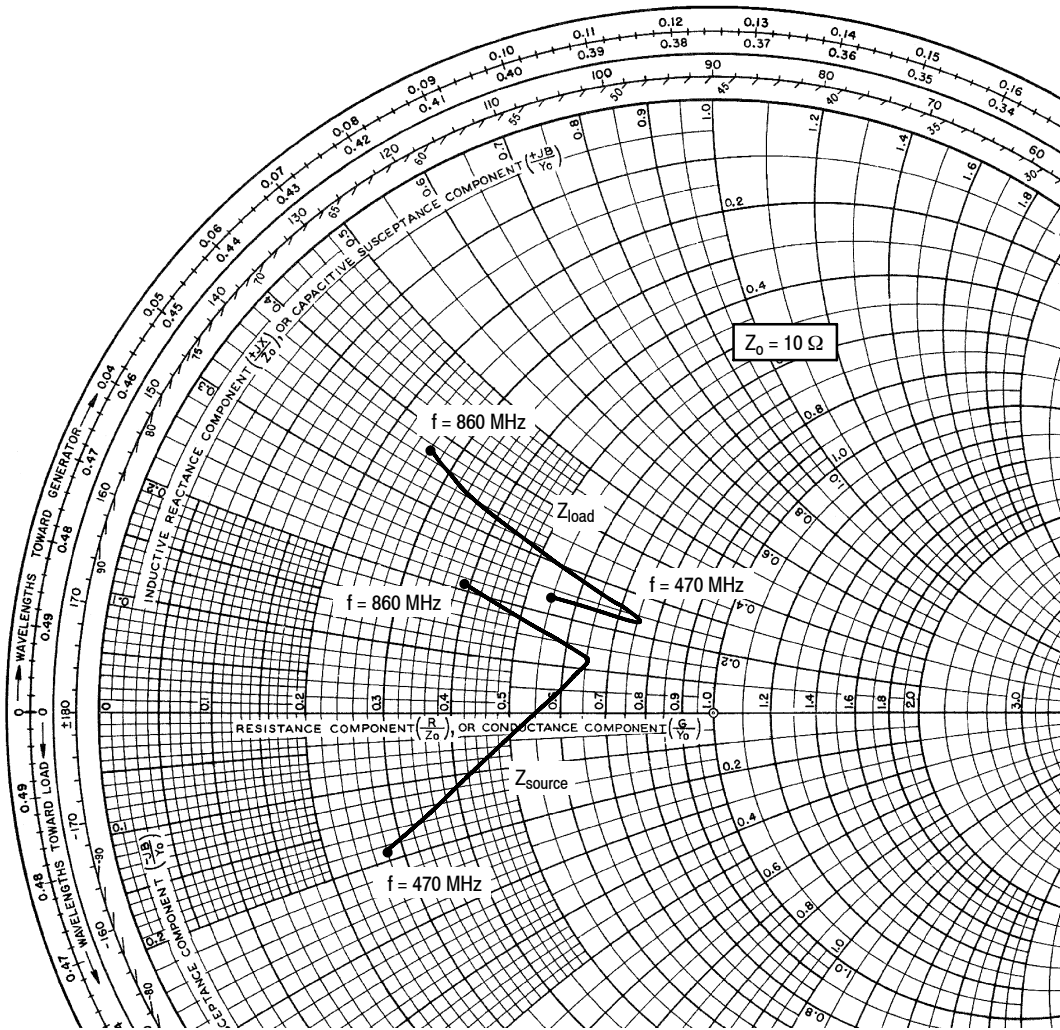
### TYPICAL CHARACTERISTICS



This above graph displays calculated MTTF in hours when the device is operated at  $V_{DD} = 50 \text{ Vdc}$ ,  $P_{out} = 90 \text{ W Avg.}$ , and  $\eta_D = 28\%$ .

MTTF calculator available at <http://www.freescale.com/rf>. Select Software & Tools/Development Tools/Calculators to access MTTF calculators by product.

**Figure 23. MTTF versus Junction Temperature**



$V_{DD} = 50 \text{ Vdc}$ ,  $I_{DQ} = 1400 \text{ mA}$ ,  $P_{out} = 90 \text{ W Avg.}$

f MHz	$Z_{source}$ $\Omega$	$Z_{load}$ $\Omega$
470	$2.81 - j1.88$	$5.52 + j2.34$
650	$6.46 + j1.21$	$7.46 + j2.26$
860	$3.90 + j2.09$	$2.60 + j3.73$

$Z_{source}$  = Test circuit impedance as measured from gate to gate, balanced configuration.

$Z_{load}$  = Test circuit impedance as measured from drain to drain, balanced configuration.

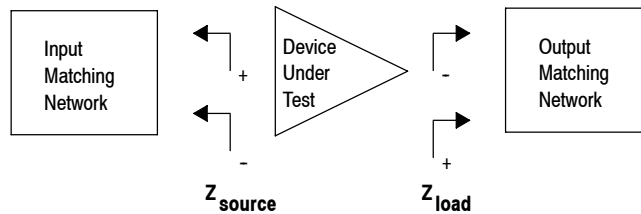


Figure 24. Series Equivalent Source and Load Impedance



NOTES:

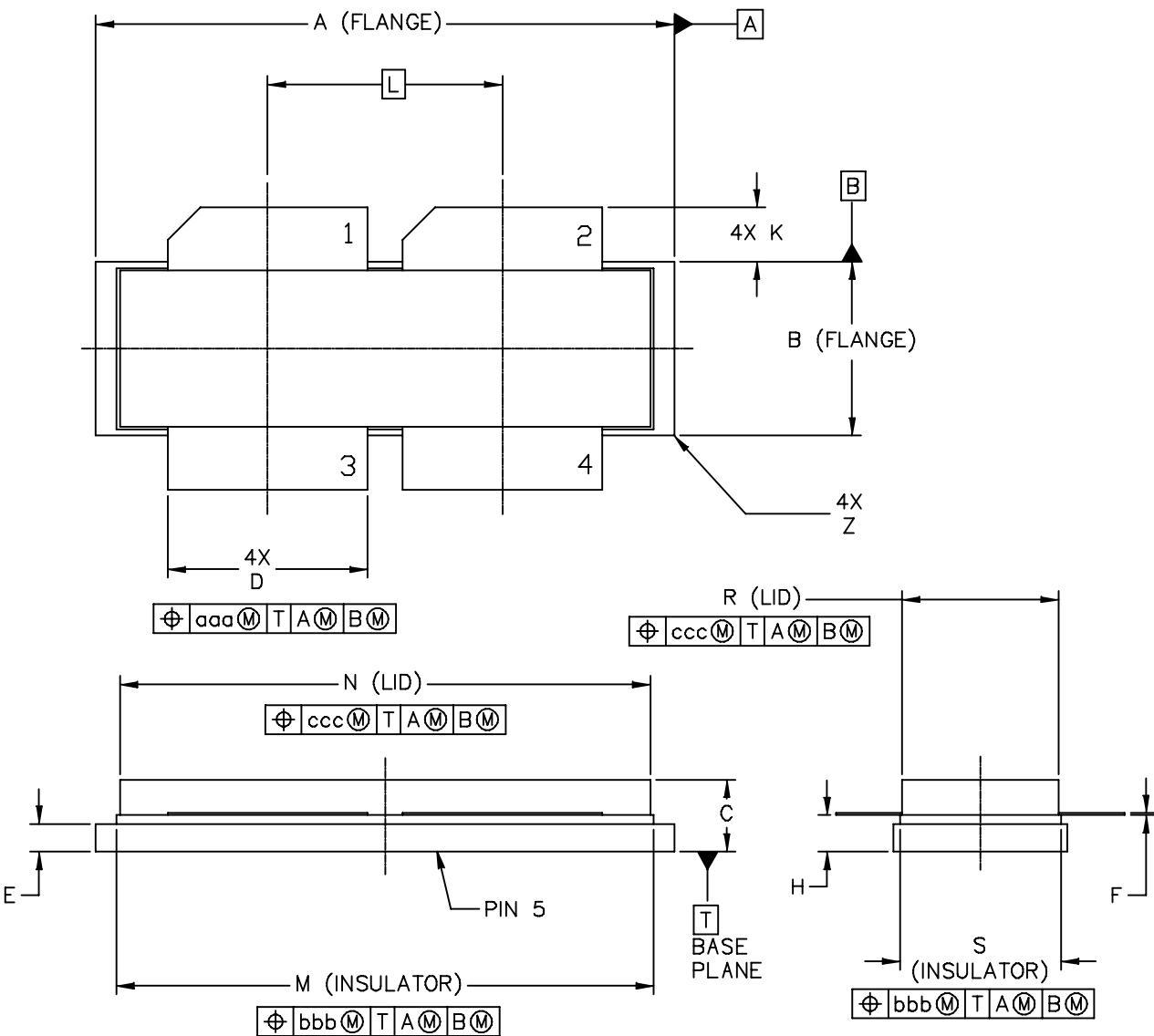
- 1.0 INTERPRET DIMENSIONS AND TOLERANCES PER ASME Y14.5M-1994.
- 2.0 CONTROLLING DIMENSION: INCH
- 3.0 DIMENSION H IS MEASURED .030 (0.762) AWAY FROM PACKAGE BODY.
- 4.0 RECOMMENDED BOLT CENTER DIMENSION OF 1.52 (38.61) BASED ON M3 SCREW.

STYLE 1:

- PIN 1 - DRAIN
- 2 - DRAIN
- 3 - GATE
- 4 - GATE
- 5 - SOURCE

DIM	INCH		MILLIMETER		DIM	INCH		MILLIMETER	
	MIN	MAX	MIN	MAX		MIN	MAX	MIN	MAX
A	1.615	1.625	41.02	41.28	N	1.218	1.242	30.94	31.55
B	.395	.405	10.03	10.29	Q	.120	.130	3.05	3.3
C	.150	.200	3.81	5.08	R	.355	.365	9.01	9.27
D	.455	.465	11.56	11.81	S	.365	.375	9.27	9.53
E	.062	.066	1.57	1.68					
F	.004	.007	0.1	0.18					
G	1.400 BSC		35.56 BSC		aaa	.013		0.33	
H	.082	.090	2.08	2.29	bbb	.010		0.25	
K	.117	.137	2.97	3.48	ccc	.020		0.51	
L	.540 BSC		13.72 BSC						
M	1.219	1.241	30.96	31.52					

© FREESCALE SEMICONDUCTOR, INC. ALL RIGHTS RESERVED.		<b>MECHANICAL OUTLINE</b>		PRINT VERSION NOT TO SCALE	
TITLE:  NI-1230		DOCUMENT NO: 98ASB16977C		REV: E	
		CASE NUMBER: 375D-05		31 MAR 2005	
		STANDARD: NON-JEDEC			



© FREESCALE SEMICONDUCTOR, INC. ALL RIGHTS RESERVED.		MECHANICAL OUTLINE		PRINT VERSION NOT TO SCALE	
TITLE:  NI-1230S		DOCUMENT NO: 98ARB18247C		REV: F	
		CASE NUMBER: 375E-04		05 AUG 2005	
		STANDARD: NON-JEDEC			

NOTES:

1. INTERPRET DIMENSIONS AND TOLERANCES PER ASME Y14.5M-1994.
2. CONTROLLING DIMENSION: INCH
3. DIMENSION H IS MEASURED .030 AWAY FROM PACKAGE BODY

STYLE 1:

- PIN 1 - DRAIN
- 2 - DRAIN
- 3 - GATE
- 4 - GATE
- 5 - SOURCE

DIM	INCHES		MILLIMETERS		DIM	INCHES		MILLIMETERS	
	MIN	MAX	MIN	MAX		MIN	MAX	MIN	MAX
A	1.265	1.275	32.13	32.38	R	.355	.365	9.01	9.27
B	.395	.405	10.03	10.29	S	.365	.375	9.27	9.53
C	.150	.200	3.81	5.08	Z	---	.040	---	1.02
D	.455	.465	11.56	11.81					
E	.062	.066	1.57	1.68	aaa	.013		0.33	
F	.004	.007	0.1	0.18	bbb	.010		0.25	
H	.082	.090	2.08	2.29	ccc	.020		0.51	
K	.117	.137	2.97	3.48					
L	.540 BSC		13.72 BSC						
M	1.219	1.241	30.96	31.52					
N	1.218	1.242	30.94	31.55					
© FREESCALE SEMICONDUCTOR, INC. ALL RIGHTS RESERVED.			MECHANICAL OUTLINE			PRINT VERSION NOT TO SCALE			
TITLE:  NI-1230S					DOCUMENT NO: 98ARB18247C			REV: F	
					CASE NUMBER: 375E-04			05 AUG 2005	
					STANDARD: NON-JEDEC				

Refer to the following documents to aid your design process.

**Application Notes**

- AN1955: Thermal Measurement Methodology of RF Power Amplifiers

**Engineering Bulletins**

- EB212: Using Data Sheet Impedances for RF LDMOS Devices

**Software**

- Electromigration MTTF Calculator
- RF High Power Model

For Software, do a Part Number search at <http://www.freescale.com>, and select the “Part Number” link. Go to the Software & Tools tab on the part’s Product Summary page to download the respective tool.

**REVISION HISTORY**

The following table summarizes revisions to this document.

Revision	Date	Description
0	July 2008	<ul style="list-style-type: none"> <li>• Initial Release of Data Sheet</li> </ul>
1	Aug. 2008	<ul style="list-style-type: none"> <li>• Corrected component designation part number for C34, 35 in Table 5. Test Circuit Component Designation and Values, p. 5</li> <li>• Added Note to Fig. 4, Capacitance versus Drain–Source Voltage and Fig. 5, DC Safe Operating Area to denote that each side of device is measured separately, p. 7</li> <li>• Adjusted imaginary component signs in Fig. 24, Series Equivalent Source and Load Impedance data table and replotted data, p. 12</li> </ul>
2	Sept. 2008	<ul style="list-style-type: none"> <li>• Fig. 24, Series Equivalent Source and Load Impedance, corrected <math>Z_{source}</math> copy to read “Test circuit impedance as measured from gate to gate, balanced configuration” and <math>Z_{load}</math> copy to read “Test circuit impedance as measured from gate to gate, balanced configuration”, p. 12</li> </ul>
2.1	Nov. 2008	<ul style="list-style-type: none"> <li>• Corrected Fig. 24 Revision History <math>Z_{load}</math> copy to read “Test circuit impedance as measured from drain to drain, balanced configuration”, p. 12</li> </ul>
3	July 2009	<ul style="list-style-type: none"> <li>• Added capability of handling 10:1 VSWR @ 50 Vdc, 850 MHz, 450 Watts CW, p. 1</li> <li>• Added thermal resistance at 450 W CW, Thermal Characteristics table, p. 2</li> <li>• Corrected Fig. 23, MTTF versus Junction Temperature, to match values given by the MRF6VP3450H/HS MTTF calculator, p. 11</li> <li>• Added Electromigration MTTF Calculator and RF High Power Model availability to Product Software, p. 17</li> </ul>
4	Apr. 2010	<ul style="list-style-type: none"> <li>• Operating Junction Temperature increased from 200°C to 225°C in Maximum Ratings table and related “Continuous use at maximum temperature will affect MTTF” footnote added, p. 1</li> <li>• Reporting of pulsed thermal data now shown using the <math>Z_{\theta JC}</math> symbol, p. 2</li> <li>• Fig. 2, Test Circuit Schematic, Z-list, corrected Z4, Z5 from 1.400” x 0.590” Microstrip to 1.400” x 0.059” Microstrip, p. 4</li> </ul>

## **How to Reach Us:**

### **Home Page:**

[www.freescale.com](http://www.freescale.com)

### **Web Support:**

<http://www.freescale.com/support>

### **USA/Europe or Locations Not Listed:**

Freescale Semiconductor, Inc.  
Technical Information Center, EL516  
2100 East Elliot Road  
Tempe, Arizona 85284  
1-800-521-6274 or +1-480-768-2130  
[www.freescale.com/support](http://www.freescale.com/support)

### **Europe, Middle East, and Africa:**

Freescale Halbleiter Deutschland GmbH  
Technical Information Center  
Schatzbogen 7  
81829 Muenchen, Germany  
+44 1296 380 456 (English)  
+46 8 52200080 (English)  
+49 89 92103 559 (German)  
+33 1 69 35 48 48 (French)  
[www.freescale.com/support](http://www.freescale.com/support)

### **Japan:**

Freescale Semiconductor Japan Ltd.  
Headquarters  
ARCO Tower 15F  
1-8-1, Shimo-Meguro, Meguro-ku,  
Tokyo 153-0064  
Japan  
0120 191014 or +81 3 5437 9125  
[support.japan@freescale.com](mailto:support.japan@freescale.com)

### **Asia/Pacific:**

Freescale Semiconductor China Ltd.  
Exchange Building 23F  
No. 118 Jianguo Road  
Chaoyang District  
Beijing 100022  
China  
+86 10 5879 8000  
[support.asia@freescale.com](mailto:support.asia@freescale.com)

### **For Literature Requests Only:**

Freescale Semiconductor Literature Distribution Center  
1-800-441-2447 or +1-303-675-2140  
Fax: +1-303-675-2150  
[LDCForFreescaleSemiconductor@hibbertgroup.com](mailto:LDCForFreescaleSemiconductor@hibbertgroup.com)

Information in this document is provided solely to enable system and software implementers to use Freescale Semiconductor products. There are no express or implied copyright licenses granted hereunder to design or fabricate any integrated circuits or integrated circuits based on the information in this document.

Freescale Semiconductor reserves the right to make changes without further notice to any products herein. Freescale Semiconductor makes no warranty, representation or guarantee regarding the suitability of its products for any particular purpose, nor does Freescale Semiconductor assume any liability arising out of the application or use of any product or circuit, and specifically disclaims any and all liability, including without limitation consequential or incidental damages. "Typical" parameters that may be provided in Freescale Semiconductor data sheets and/or specifications can and do vary in different applications and actual performance may vary over time. All operating parameters, including "Typicals", must be validated for each customer application by customer's technical experts. Freescale Semiconductor does not convey any license under its patent rights nor the rights of others. Freescale Semiconductor products are not designed, intended, or authorized for use as components in systems intended for surgical implant into the body, or other applications intended to support or sustain life, or for any other application in which the failure of the Freescale Semiconductor product could create a situation where personal injury or death may occur. Should Buyer purchase or use Freescale Semiconductor products for any such unintended or unauthorized application, Buyer shall indemnify and hold Freescale Semiconductor and its officers, employees, subsidiaries, affiliates, and distributors harmless against all claims, costs, damages, and expenses, and reasonable attorney fees arising out of, directly or indirectly, any claim of personal injury or death associated with such unintended or unauthorized use, even if such claim alleges that Freescale Semiconductor was negligent regarding the design or manufacture of the part.

Freescale™ and the Freescale logo are trademarks of Freescale Semiconductor, Inc. All other product or service names are the property of their respective owners.

© Freescale Semiconductor, Inc. 2008-2010. All rights reserved.

## Looking for pricing, stock, or lifecycle information?

Click below to explore more details on WIN SOURCE:

- ⊖ [View MRF6VP3450HR5 on WIN SOURCE](#)
- ⊖ [Freescale Semiconductor - NXP Information](#)

## Optimize Your Supply Chain with WIN SOURCE Solutions

- ✓ Global Sourcing Solution
- ✓ Obsolete Management
- ✓ Cost Control Management
- ✓ Shortage Management
- ✓ Alternative Solution
- ✓ Excess Inventory Management