



**THE DATASHEET OF
MRF7S19080HSR3**



RF Power Field Effect Transistors

N-Channel Enhancement-Mode Lateral MOSFETs

Designed for CDMA base station applications with frequencies from 1930 to 1990 MHz. Suitable for CDMA and multicarrier amplifier applications. To be used in Class AB and Class C for TD-SCDMA and PCN-PCS/cellular radio applications.

- Typical Single-Carrier W-CDMA Performance: $V_{DD} = 28$ Volts, $I_{DQ} = 750$ mA, $P_{out} = 24$ Watts Avg., $f = 1987.5$ MHz, IQ Magnitude Clipping, Channel Bandwidth = 3.84 MHz, Input Signal PAR = 7.5 dB @ 0.01% Probability on CCDF.
 - Power Gain — 18 dB
 - Drain Efficiency — 32%
 - Device Output Signal PAR — 6.2 dB @ 0.01% Probability on CCDF
 - ACPR @ 5 MHz Offset — -38 dBc in 3.84 MHz Channel Bandwidth
- Capable of Handling 10:1 VSWR, @ 32 Vdc, 1960 MHz, 80 Watts CW Output Power
- P_{out} @ 1 dB Compression Point \approx 80 Watts CW

Features

- 100% PAR Tested for Guaranteed Output Power Capability
- Characterized with Series Equivalent Large-Signal Impedance Parameters
- Internally Matched for Ease of Use
- Integrated ESD Protection
- Greater Negative Gate-Source Voltage Range for Improved Class C Operation
- Designed for Digital Predistortion Error Correction Systems
- RoHS Compliant
- In Tape and Reel. R3 Suffix = 250 Units, 56 mm Tape Width, 13 inch Reel.

MRF7S19080HR3
MRF7S19080HSR3

1930-1990 MHz, 24 W AVG., 28 V
SINGLE W-CDMA
LATERAL N-CHANNEL
RF POWER MOSFETs

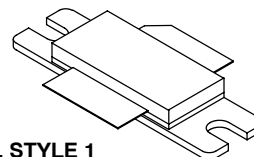

CASE 465-06, STYLE 1
NI-780
MRF7S19080HR3

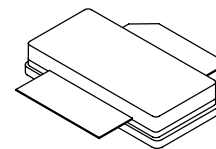

CASE 465A-06, STYLE 1
NI-780S
MRF7S19080HSR3

Table 1. Maximum Ratings

Rating	Symbol	Value	Unit
Drain-Source Voltage	V_{DSS}	-0.5, +65	Vdc
Gate-Source Voltage	V_{GS}	-6.0, +10	Vdc
Operating Voltage	V_{DD}	32, +0	Vdc
Storage Temperature Range	T_{stg}	- 65 to +150	°C
Case Operating Temperature	T_C	150	°C
Operating Junction Temperature (1,2)	T_J	225	°C

Table 2. Thermal Characteristics

Characteristic	Symbol	Value (2,3)	Unit
Thermal Resistance, Junction to Case	$R_{\theta JC}$		°C/W
Case Temperature 81°C, 79 W CW		0.60	
Case Temperature 79°C, 24 W CW		0.69	

1. Continuous use at maximum temperature will affect MTTF.
2. MTTF calculator available at <http://www.freescale.com/rf>. Select Software & Tools/Development Tools/Calculators to access MTTF calculators by product.
3. Refer to AN1955, *Thermal Measurement Methodology of RF Power Amplifiers*. Go to <http://www.freescale.com/rf>. Select Documentation/Application Notes - AN1955.

Table 3. ESD Protection Characteristics

Test Methodology	Class
Human Body Model (per JESD22-A114)	1C (Minimum)
Machine Model (per EIA/JESD22-A115)	A (Minimum)
Charge Device Model (per JESD22-C101)	IV (Minimum)

Table 4. Electrical Characteristics ($T_A = 25^\circ\text{C}$ unless otherwise noted)

Characteristic	Symbol	Min	Typ	Max	Unit
----------------	--------	-----	-----	-----	------

Off Characteristics

Zero Gate Voltage Drain Leakage Current ($V_{DS} = 65\text{ Vdc}$, $V_{GS} = 0\text{ Vdc}$)	I_{DSS}	—	—	10	μAdc
Zero Gate Voltage Drain Leakage Current ($V_{DS} = 28\text{ Vdc}$, $V_{GS} = 0\text{ Vdc}$)	I_{DSS}	—	—	1	μAdc
Gate-Source Leakage Current ($V_{GS} = 5\text{ Vdc}$, $V_{DS} = 0\text{ Vdc}$)	I_{GSS}	—	—	1	μAdc

On Characteristics

Gate Threshold Voltage ($V_{DS} = 10\text{ Vdc}$, $I_D = 174\ \mu\text{Adc}$)	$V_{GS(th)}$	1.2	2	2.7	Vdc
Gate Quiescent Voltage ($V_{DD} = 28\text{ Vdc}$, $I_D = 750\text{ mAdc}$, Measured in Functional Test)	$V_{GS(Q)}$	2	2.7	3.5	Vdc
Drain-Source On-Voltage ($V_{GS} = 10\text{ Vdc}$, $I_D = 1.74\text{ Adc}$)	$V_{DS(on)}$	0.1	0.21	0.3	Vdc

Dynamic Characteristics ⁽¹⁾

Reverse Transfer Capacitance ($V_{DS} = 28\text{ Vdc} \pm 30\text{ mV(rms)ac}$ @ 1 MHz, $V_{GS} = 0\text{ Vdc}$)	C_{rss}	—	0.64	—	pF
Output Capacitance ($V_{DS} = 28\text{ Vdc} \pm 30\text{ mV(rms)ac}$ @ 1 MHz, $V_{GS} = 0\text{ Vdc}$)	C_{oss}	—	297	—	pF

Functional Tests (In Freescale Test Fixture, 50 ohm system) $V_{DD} = 28\text{ Vdc}$, $I_{DQ} = 750\text{ mA}$, $P_{out} = 24\text{ W Avg.}$, $f = 1987.5\text{ MHz}$, Single-Carrier W-CDMA, IQ Magnitude Clipping, PAR = 7.5 dB @ 0.01% Probability on CCDF. ACPR measured in 3.84 MHz Channel Bandwidth @ $\pm 5\text{ MHz}$ Offset.

Power Gain	G_{ps}	17	18	20	dB
Drain Efficiency	η_D	30	32	—	%
Output Peak-to-Average Ratio @ 0.01% Probability on CCDF	PAR	5.7	6.2	—	dB
Adjacent Channel Power Ratio	ACPR	—	-38	-35	dBc
Input Return Loss	IRL	—	-20	-9	dB

1. Part internally matched both on input and output.

(continued)

Table 4. Electrical Characteristics ($T_A = 25^\circ\text{C}$ unless otherwise noted) (continued)

Characteristic	Symbol	Min	Typ	Max	Unit
Typical Performances (In Freescale Test Fixture, 50 ohm system) $V_{DD} = 28\text{ Vdc}$, $I_{DQ} = 750\text{ mA}$, 1930-1990 MHz Bandwidth					
Video Bandwidth @ 80 W PEP P_{out} where $IM3 = -30\text{ dBc}$ (Tone Spacing from 100 kHz to VBW) $\Delta IMD3 = IMD3 @ \text{VBW frequency} - IMD3 @ 100\text{ kHz} < 1\text{ dBc}$ (both sidebands)	VBW	—	90	—	MHz
Gain Flatness in 60 MHz Bandwidth @ $P_{out} = 24\text{ W Avg.}$	G_F	—	0.165	—	dB
Average Deviation from Linear Phase in 60 MHz Bandwidth @ $P_{out} = 80\text{ W CW}$	Φ	—	1.14	—	$^\circ$
Average Group Delay @ $P_{out} = 80\text{ W CW}$, $f = 1960\text{ MHz}$	Delay	—	2.25	—	ns
Part-to-Part Insertion Phase Variation @ $P_{out} = 80\text{ W CW}$, $f = 1960\text{ MHz}$, Six Sigma Window	$\Delta\Phi$	—	22.3	—	$^\circ$
Gain Variation over Temperature (-30°C to $+85^\circ\text{C}$)	ΔG	—	0.009	—	dB/ $^\circ\text{C}$
Output Power Variation over Temperature (-30°C to $+85^\circ\text{C}$)	ΔP_{1dB}	—	0.017	—	dB/ $^\circ\text{C}$

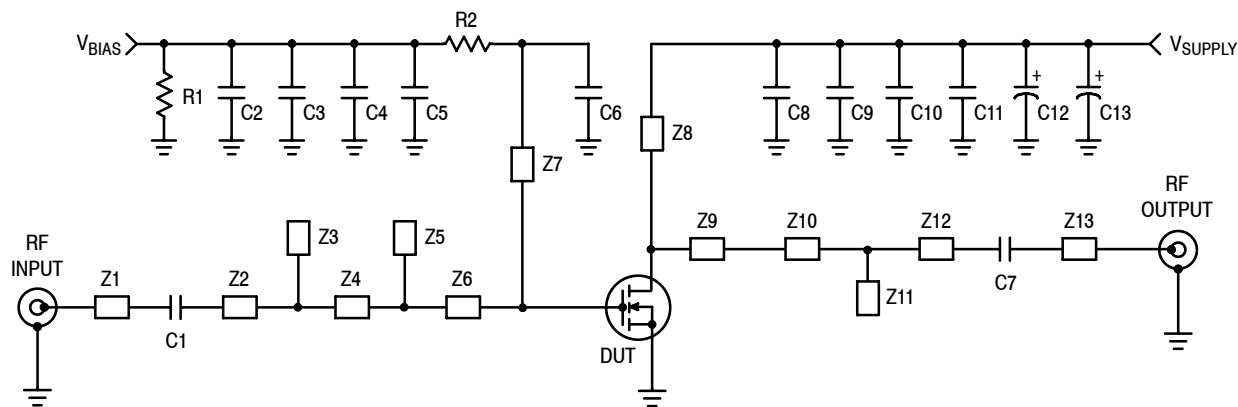

Z1	0.530" x 0.084" Microstrip	Z8	0.306" x 0.388" x 0.090" Taper
Z2	0.336" x 0.084" Microstrip	Z9	0.880" x 0.201" x 0.795" Taper
Z3	0.211" x 0.180" x 0.084" Taper	Z10	0.415" x 0.084" Microstrip
Z4	0.704" x 0.216" Microstrip	Z11	0.191" x 0.243" x 0.084" Taper
Z5	0.220" x 0.216" x 0.084" Taper	Z12	0.510" x 0.084" Microstrip
Z6	0.504" x 0.800" x 0.084" Taper	Z13	0.525" x 0.084" Microstrip
Z7	0.265" x 0.313" x 0.332" x 0.040" Taper	PCB	Arlon CuClad 250GX-0300-55-22, 0.030", $\epsilon_r = 2.55$

Figure 1. MRF7S19080HR3(HSR3) Test Circuit Schematic

Table 5. MRF7S19080HR3(HSR3) Test Circuit Component Designations and Values

Part	Description	Part Number	Manufacturer
C1, C7	15 pF Chip Capacitors	ATC100B150JT500XT	ATC
C2, C11	13 pF Chip Capacitors	ATC100B130JT500XT	ATC
C3	10 μ F Chip Capacitor	GRM31MF51A106ZA01B	TDK
C4	1000 pF Chip Capacitor	ATC100B102JT50XT	ATC
C5, C10	0.1 μ F Chip Capacitors	C1206C104K5RAC	Kemet
C6	5.1 pF Chip Capacitor	ATC100B5R1CT500XT	ATC
C8	6.8 pF Chip Capacitor	ATC100B6R8CT500XT	ATC
C9	2.2 μ F Chip Capacitor	C1825C225J5RAC	Kemet
C12	470 μ F, 63 V Electrolytic Capacitor	EKME630ELL471MK25S	United Chemi-Con
C13	100 μ F, 50 V Electrolytic Capacitor	MCHT101M1HB-1017-RH	Multicomp
R1	330 Ω , 1/4 W Chip Resistor	CRCW12063300FKEA	Vishay
R2	10 Ω , 1/4 W Chip Resistor	CRCW120610R0FKEA	Vishay

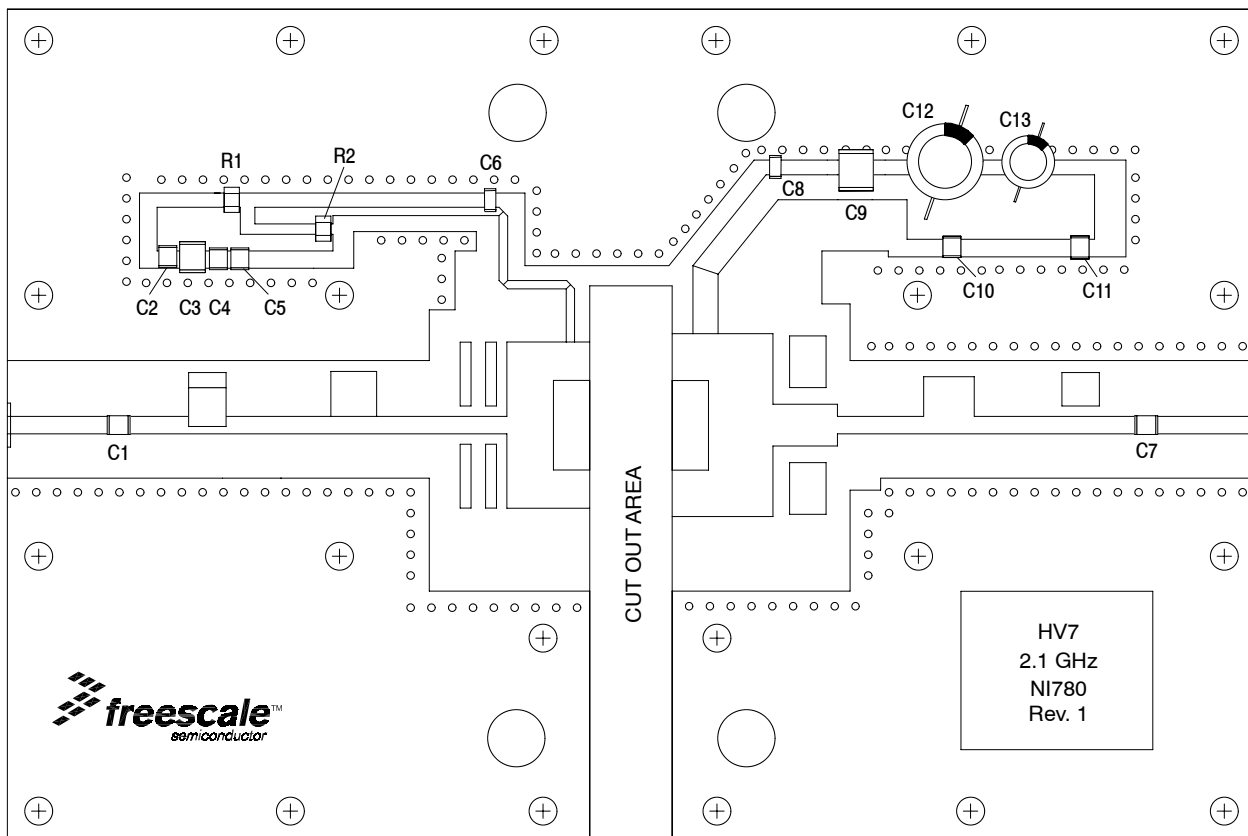

Figure 2. MRF7S19080HR3(HSR3) Test Circuit Component Layout

TYPICAL CHARACTERISTICS

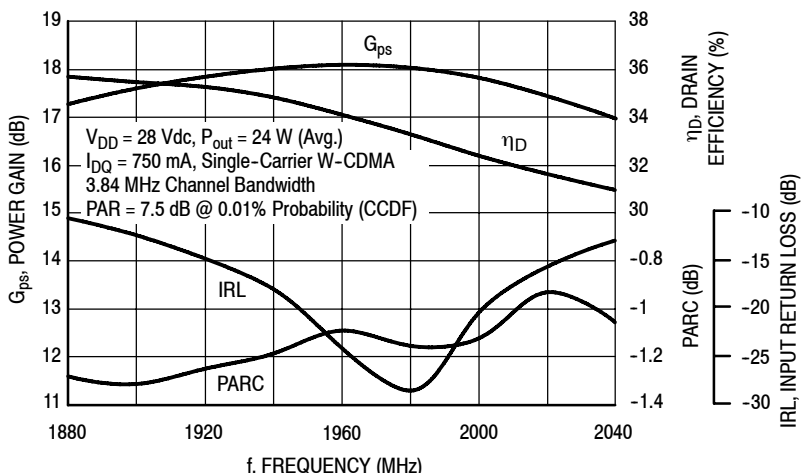

Figure 3. Output Peak-to-Average Ratio Compression (PARC) Broadband Performance @ $P_{out} = 24$ Watts Avg.

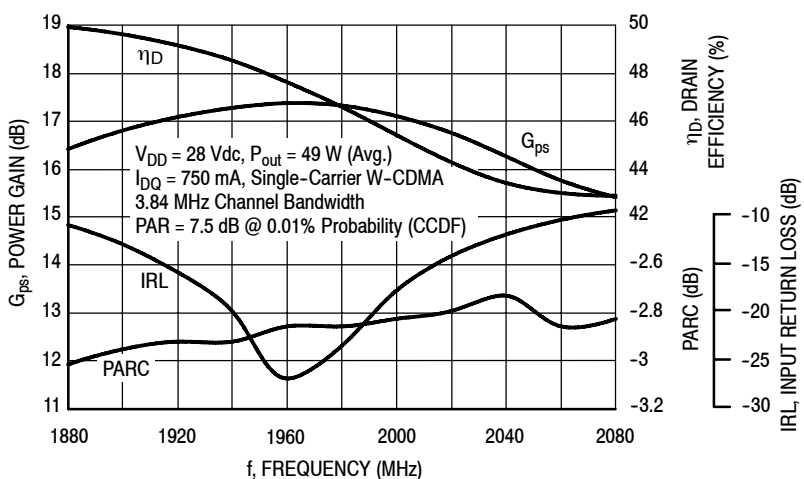

Figure 4. Output Peak-to-Average Ratio Compression (PARC) Broadband Performance @ $P_{out} = 49$ Watts Avg.

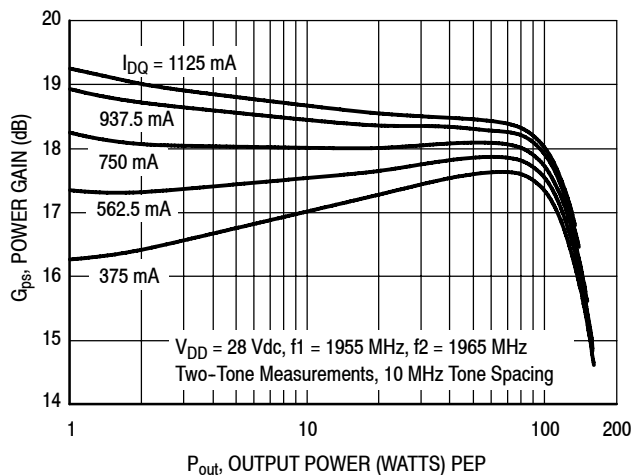

Figure 5. Two-Tone Power Gain versus Output Power

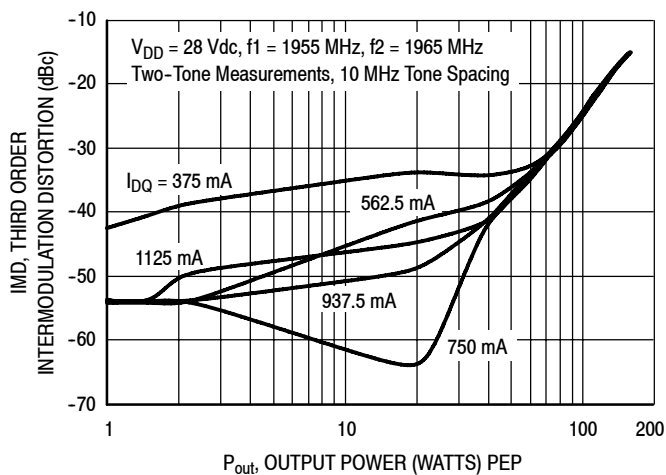

Figure 6. Third Order Intermodulation Distortion versus Output Power

TYPICAL CHARACTERISTICS

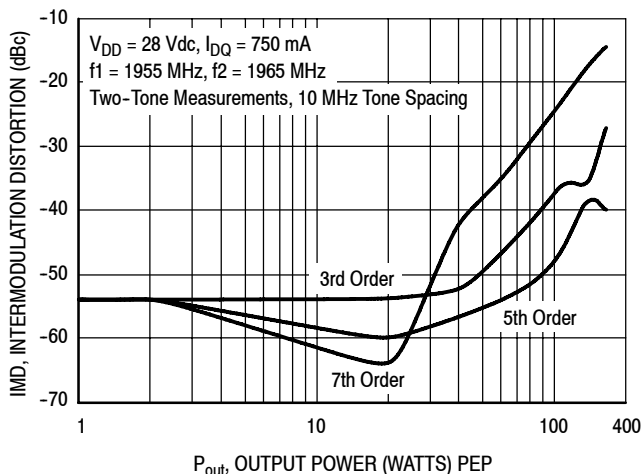

Figure 7. Intermodulation Distortion Products versus Output Power

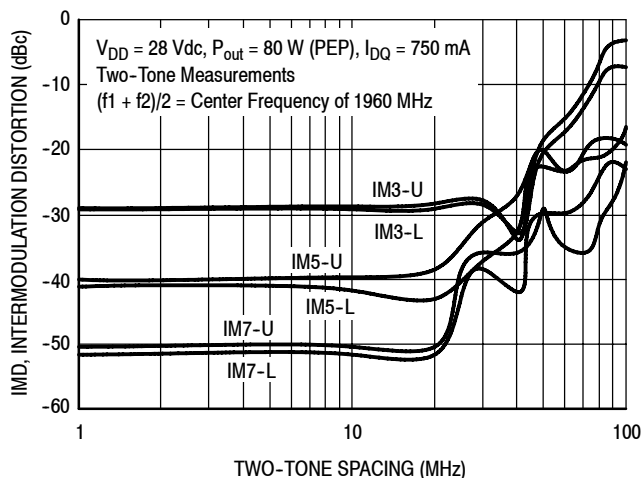

Figure 8. Intermodulation Distortion Products versus Tone Spacing

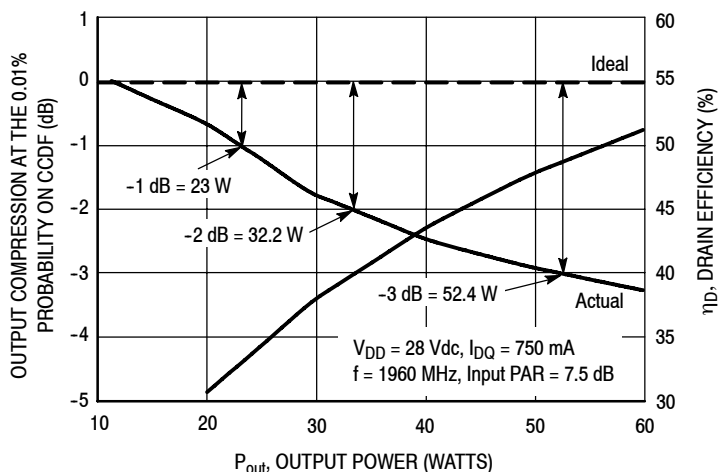

Figure 9. Output Peak-to-Average Ratio Compression (PARC) versus Output Power

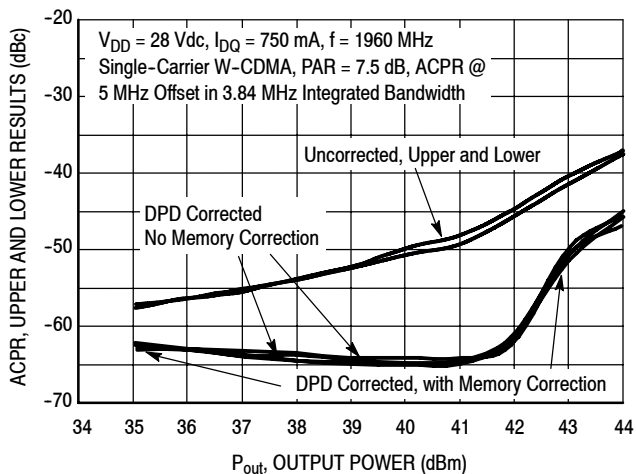

Figure 10. Digital Predistortion Correction versus ACPR and Output Power

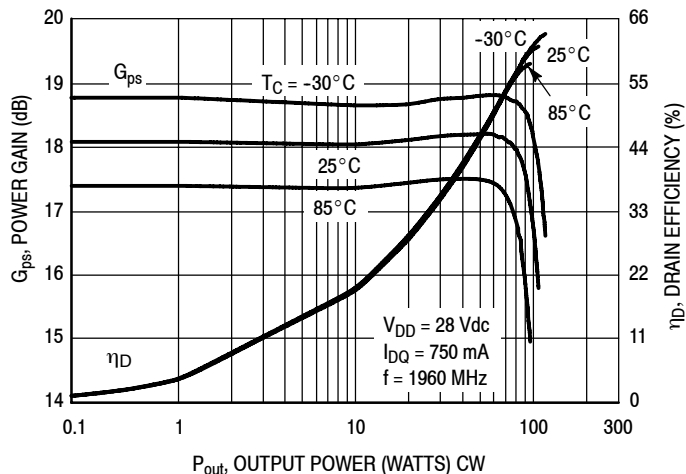

Figure 11. Power Gain and Drain Efficiency versus CW Output Power

TYPICAL CHARACTERISTICS

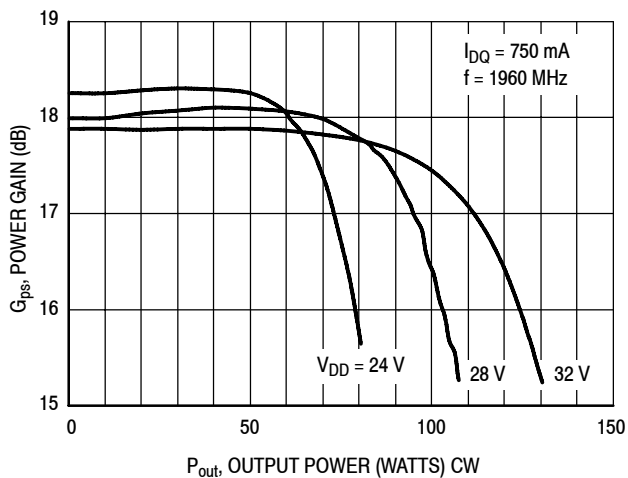

Figure 12. Power Gain versus Output Power

W-CDMA TEST SIGNAL

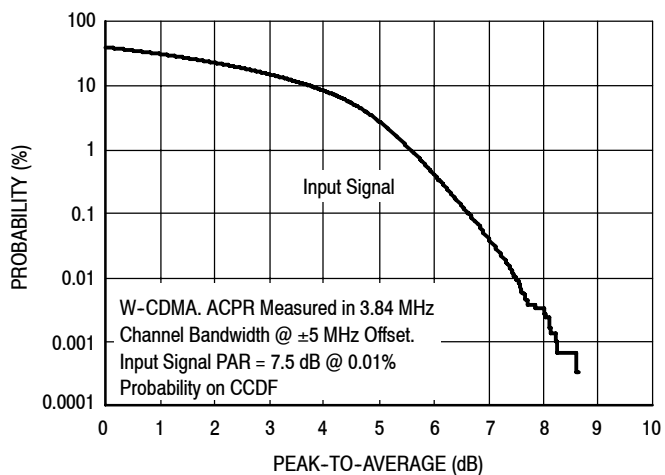

Figure 13. CCDF W-CDMA IQ Magnitude Clipping, Single-Carrier Test Signal

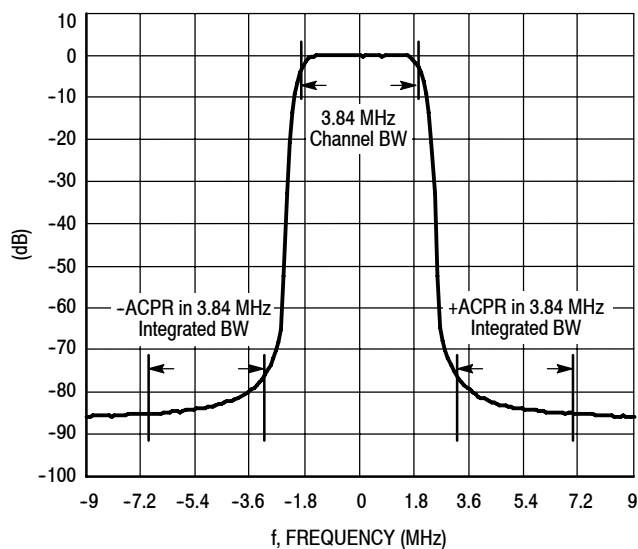
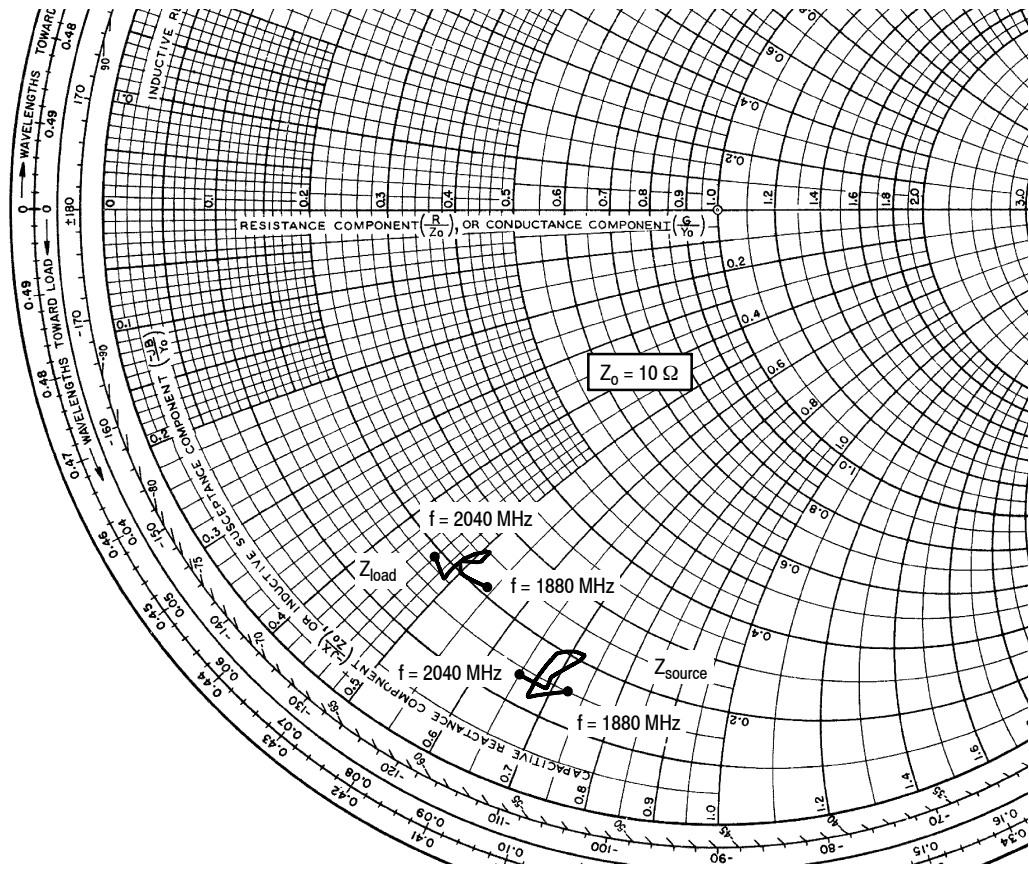

Figure 14. Single-Carrier W-CDMA Spectrum



$V_{DD} = 28 \text{ Vdc}$, $I_{DQ} = 750 \text{ mA}$, $P_{out} = 24 \text{ W Avg.}$

f MHz	Z_{source} Ω	Z_{load} Ω
1880	1.47 - j7.3	2.10 - j5.4
1900	1.22 - j6.7	1.96 - j5.0
1920	1.43 - j6.7	2.06 - j4.9
1940	1.89 - j6.8	2.27 - j5.1
1960	2.10 - j7.1	2.45 - j5.1
1980	2.11 - j7.2	2.38 - j5.0
2000	1.60 - j6.9	2.08 - j4.9
2020	1.41 - j6.9	1.84 - j4.9
2040	1.43 - j6.5	1.89 - j4.6

Z_{source} = Test circuit impedance as measured from gate to ground.

Z_{load} = Test circuit impedance as measured from drain to ground.

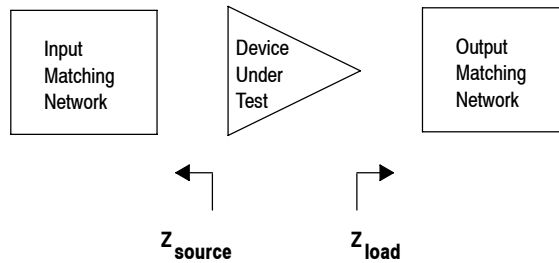
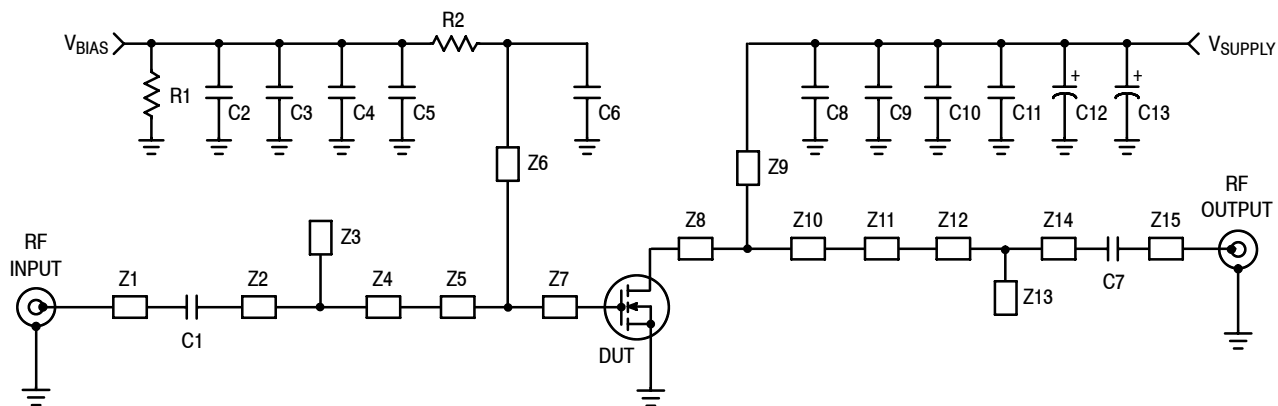

Figure 15. Series Equivalent Source and Load Impedance

TD-SCDMA CHARACTERIZATION



Z1	0.490" x 0.084" Microstrip	Z9	0.432" x 0.121" Microstrip
Z2	1.082" x 0.084" Microstrip	Z10	0.327" x 0.974" Microstrip
Z3	0.131" x 0.220" Microstrip	Z11	0.505" x 0.201" Microstrip
Z4	0.734" x 0.084" Microstrip	Z12	0.220" x 0.084" Microstrip
Z5	0.308" x 0.800" Microstrip	Z13	0.191" x 0.243" Microstrip
Z6	0.889" x 0.040" Microstrip	Z14	0.781" x 0.084" Microstrip
Z7	0.092" x 0.800" Microstrip	Z15	0.500" x 0.084" Microstrip
Z8	0.160" x 0.880" Microstrip	PCB	Arlon CuClad 250GX-0300-55-22, 0.030", $\epsilon_r = 2.55$

Figure 16. MRF7S19080HR3(HSR3) Test Circuit Schematic — TD-SCDMA

Table 6. MRF7S19080HR3(HSR3) Test Circuit Component Designations and Values — TD-SCDMA

Part	Description	Part Number	Manufacturer
C1, C7	15 pF Chip Capacitors	ATC100B150JT500XT	ATC
C2, C11	13 pF Chip Capacitors	ATC100B130JT500XT	ATC
C3	10 μ F Chip Capacitor	GRM31MF51A106ZA01B	TDK
C4	1000 pF Chip Capacitor	ATC100B102JT50XT	ATC
C5, C10	0.1 μ F Chip Capacitors	C1206C104K5RAC	Kemet
C6	5.1 pF Chip Capacitor	ATC100B5R1CT500XT	ATC
C8	6.8 pF Chip Capacitor	ATC100B6R8CT500XT	ATC
C9	2.2 μ F Chip Capacitor	C1825C225J5RAC	Kemet
C12	470 μ F, 63 V Electrolytic Capacitor	EKME630ELL471MK25S	United Chemi-Con
C13	100 μ F, 50 V Electrolytic Capacitor	MCHT101M1HB-1017-RH	Multicomp
R1	330 Ω , 1/4 W Chip Resistor	CRCW12063300FKEA	Vishay
R2	10 Ω , 1/4 W Chip Resistor	CRCW120610R0FKEA	Vishay

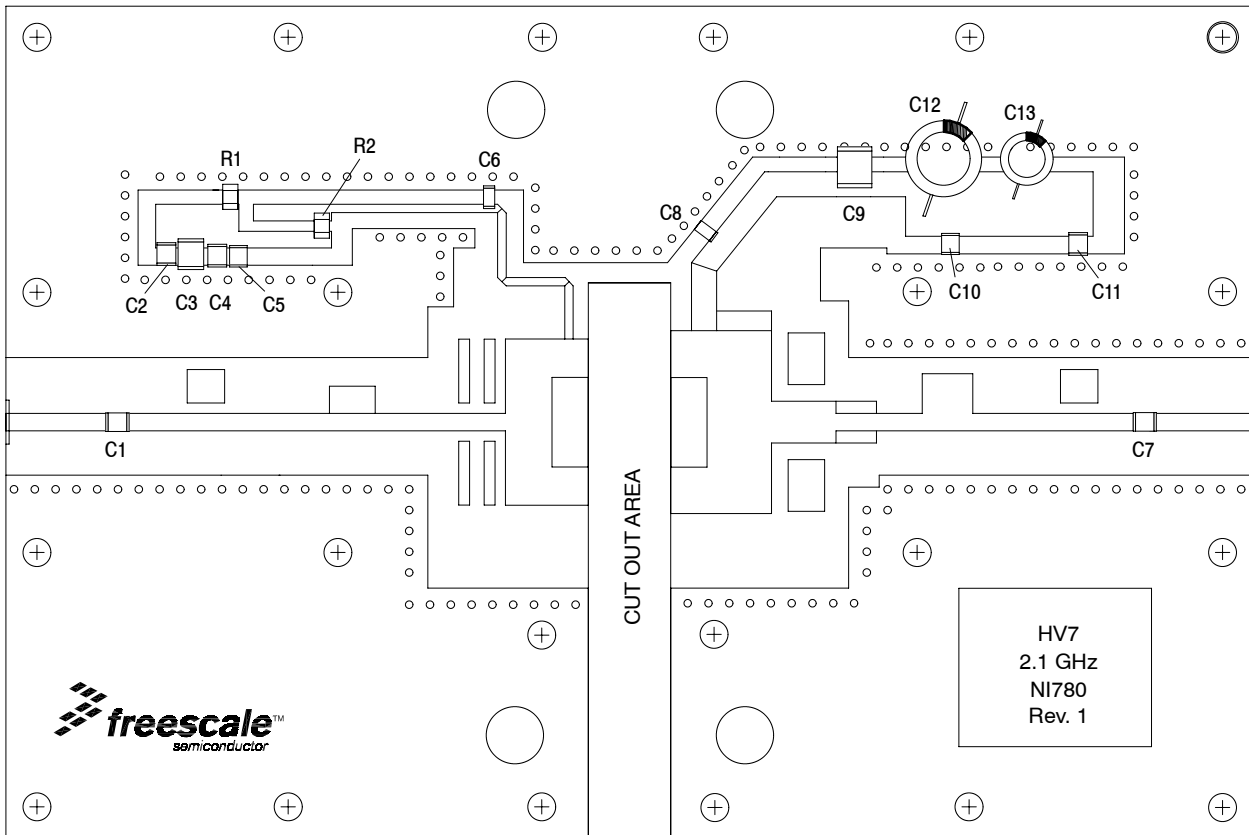

Figure 17. MRF7S19080HR3(HSR3) Test Circuit Component Layout — TD-SCDMA

TYPICAL CHARACTERISTICS

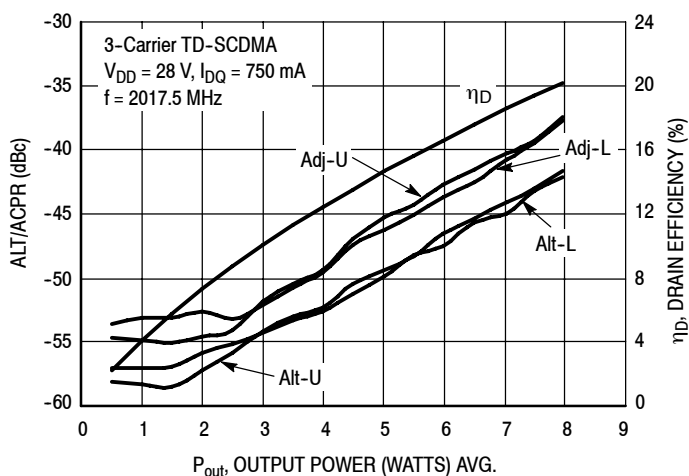

Figure 18. 3-Carrier TD-SCDMA ACPR, ALT and Drain Efficiency versus Output Power

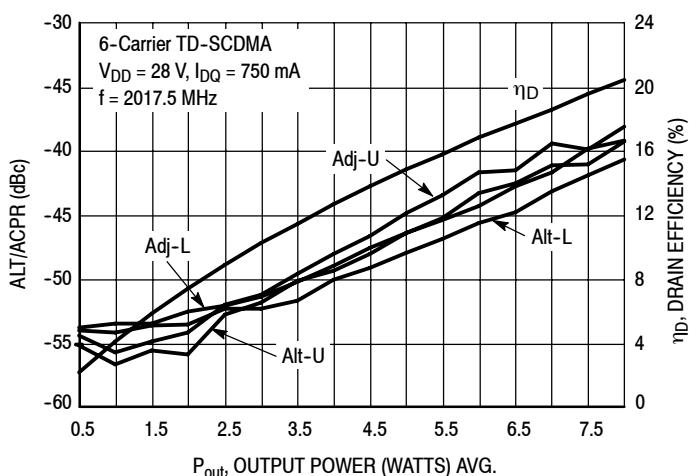

Figure 19. 6-Carrier TD-SCDMA ACPR, ALT and Drain Efficiency versus Output Power

TD-SCDMA TEST SIGNAL

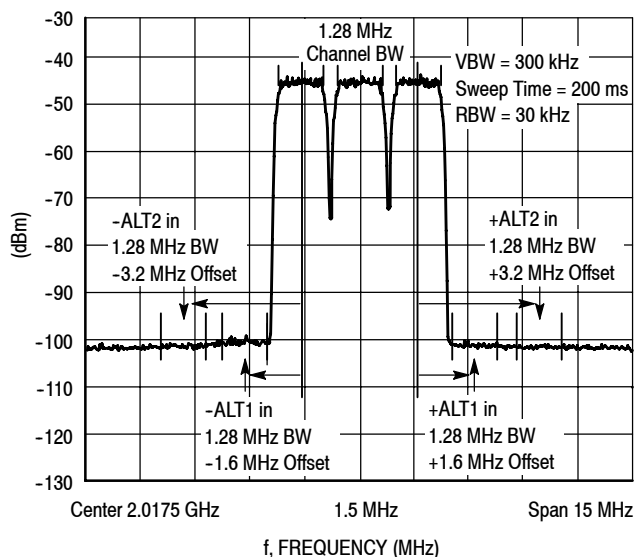

Figure 20. 3-Carrier TD-SCDMA Spectrum

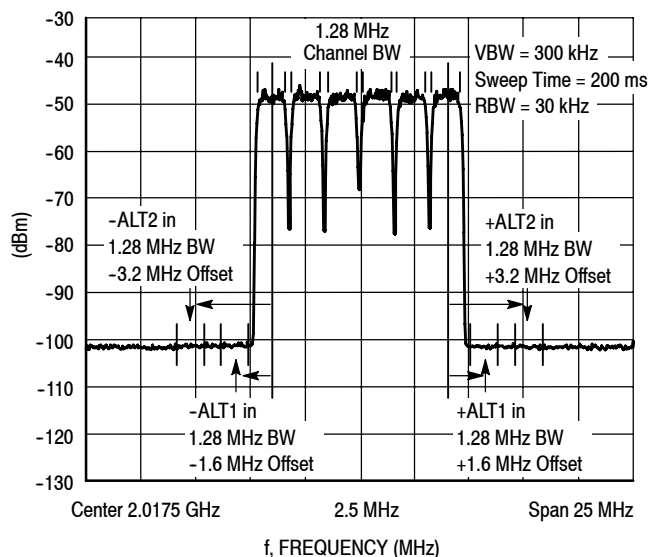
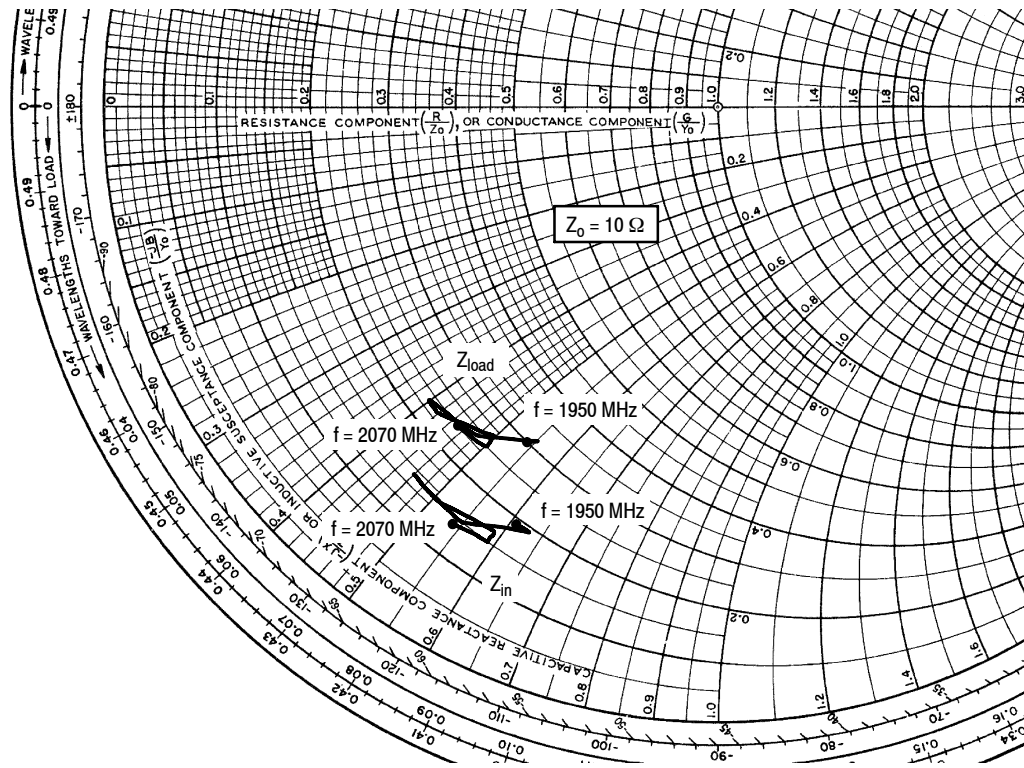

Figure 21. 6-Carrier TD-SCDMA Spectrum



$V_{DD} = 28 \text{ Vdc}$, $I_{DQ} = 750 \text{ mA}$

f MHz	Z_{in} Ω	Z_{load} Ω
1950	$1.87 - j6.10$	$2.98 - j5.42$
1960	$1.94 - j6.25$	$3.07 - j5.47$
1970	$1.77 - j6.04$	$2.87 - j5.26$
1980	$1.52 - j5.47$	$2.53 - j4.77$
1990	$1.46 - j4.92$	$2.35 - j4.26$
2000	$1.49 - j4.62$	$2.30 - j3.99$
2010	$1.53 - j4.64$	$2.34 - j3.98$
2020	$1.50 - j4.85$	$2.34 - j4.20$
2030	$1.50 - j5.15$	$2.40 - j4.44$
2040	$1.62 - j5.56$	$2.59 - j4.75$
2050	$1.63 - j5.90$	$2.68 - j5.03$
2060	$1.47 - j5.86$	$2.52 - j4.98$
2070	$1.38 - j5.40$	$2.35 - j4.54$

Z_{in} = Device input impedance as measured from gate to ground.

Z_{load} = Test circuit impedance as measured from drain to ground.

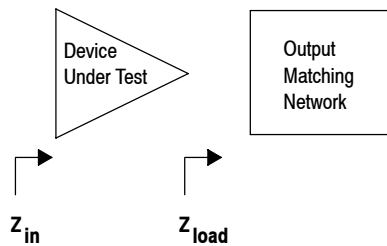
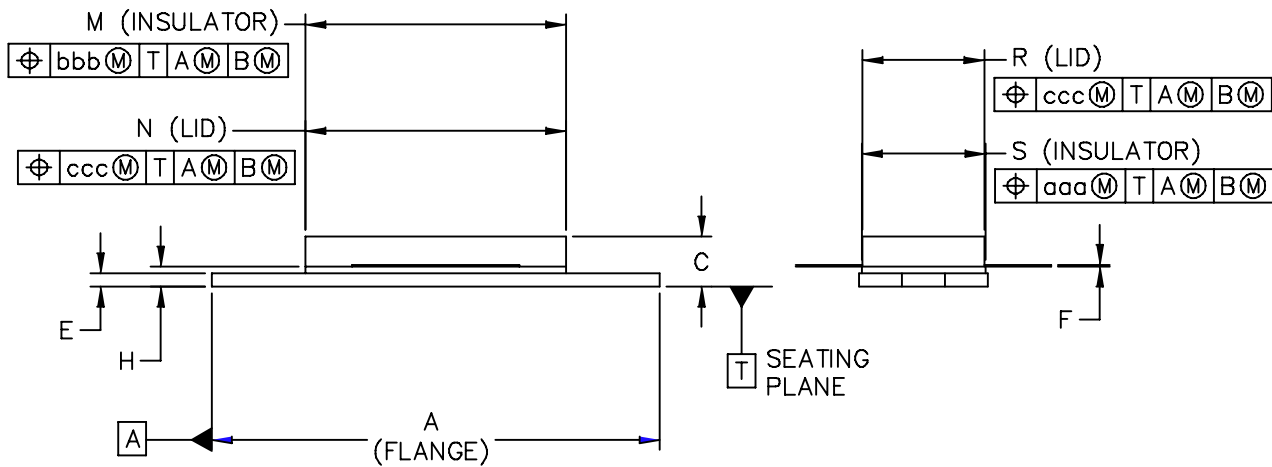
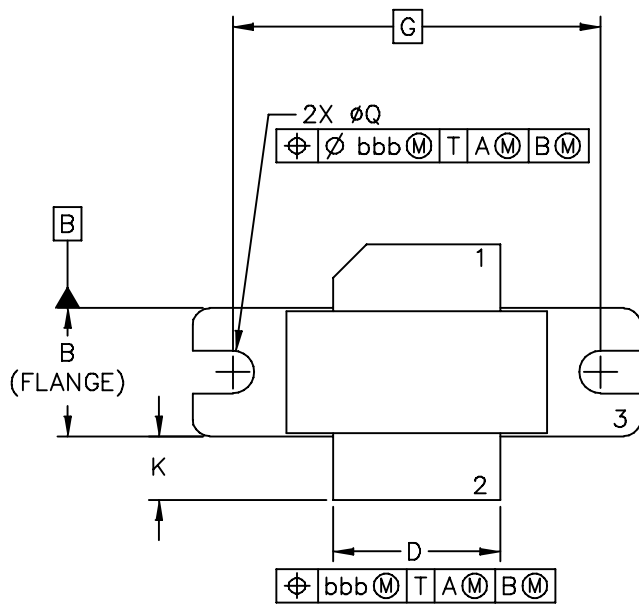

Figure 22. Series Equivalent Input and Load Impedance — TD-SCDMA

PACKAGE DIMENSIONS



© FREESCALE SEMICONDUCTOR, INC. ALL RIGHTS RESERVED.	MECHANICAL OUTLINE	PRINT VERSION NOT TO SCALE	
TITLE: NI-780	DOCUMENT NO: 98ASB15607C		REV: G
	CASE NUMBER: 465-06		31 MAR 2005
	STANDARD: NON-JEDEC		

NOTES:

1. DIMENSIONING AND TOLERANCING PER ANSI Y14.5M-1994.
2. CONTROLLING DIMENSION: INCH.
3. DELETED
4. DIMENSION H IS MEASURED .030 (.762) AWAY FROM PACKAGE BODY.

STYLE 1:

- PIN 1. DRAIN
 2. GATE
 3. SOURCE

DIM	INCH		MILLIMETER		DIM	INCH		MILLIMETER	
	MIN	MAX	MIN	MAX		MIN	MAX	MIN	MAX
A	1.335	1.345	33.91	34.16	R	.365	.375	9.27	9.53
B	.380	.390	9.65	9.91	S	.365	.375	9.27	9.52
C	.125	.170	3.18	4.32	aaa	—	.005	—	0.127
D	.495	.505	12.57	12.83	bbb	—	.010	—	0.254
E	.035	.045	0.89	1.14	ccc	—	.015	—	0.381
F	.003	.006	0.08	0.15	—	—	—	—	—
G	1.100 BSC		27.94 BSC		—	—	—	—	—
H	.057	.067	1.45	1.7	—	—	—	—	—
K	.170	.210	4.32	5.33	—	—	—	—	—
M	.774	.786	19.66	19.96	—	—	—	—	—
N	.772	.788	19.6	20	—	—	—	—	—
Q	∅.118	∅.138	∅3	∅3.51	—	—	—	—	—
© FREESCALE SEMICONDUCTOR, INC. ALL RIGHTS RESERVED.			MECHANICAL OUTLINE			PRINT VERSION NOT TO SCALE			
TITLE: NI-780					DOCUMENT NO: 98ASB15607C			REV: G	
					CASE NUMBER: 465-06			31 MAR 2005	
					STANDARD: NON-JEDEC				

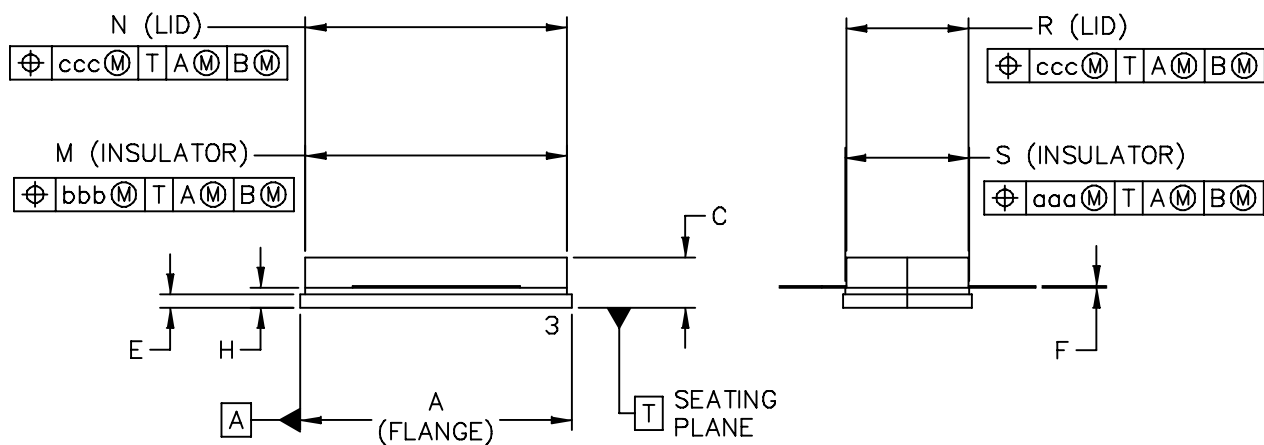
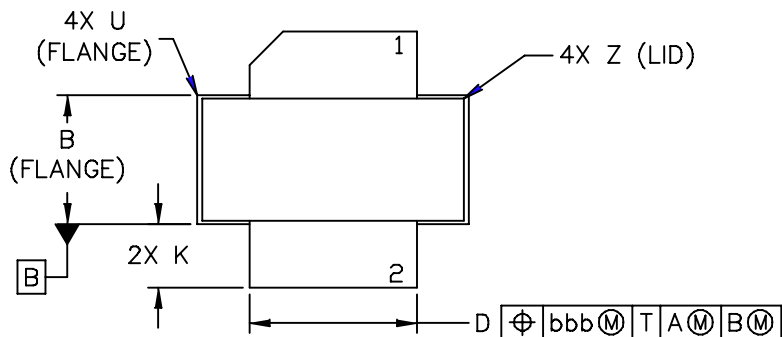

© FREESCALE SEMICONDUCTOR, INC. ALL RIGHTS RESERVED.	MECHANICAL OUTLINE	PRINT VERSION NOT TO SCALE	
TITLE: NI-780S	DOCUMENT NO: 98ASB16718C	REV: H	
	CASE NUMBER: 465A-06	31 MAR 2005	
	STANDARD: NON-JEDEC		

NOTES:

1. DIMENSIONING AND TOLERANCING PER ANSI Y14.5M-1994.
2. CONTROLLING DIMENSION: INCH.
3. DELETED
4. DIMENSION H IS MEASURED .030 (0.762) AWAY FROM PACKAGE BODY.

STYLE 1:

- PIN 1. DRAIN
2. GATE
3. SOURCE

DIM	INCH		MILLIMETER		DIM	INCH		MILLIMETER	
	MIN	MAX	MIN	MAX		MIN	MAX	MIN	MAX
A	.805	-.815	20.45	20.7	U	-.040	-	-	1.02
B	.380	-.390	9.65	9.91	Z	-.030	-	-	0.76
C	.125	-.170	3.18	4.32	aaa	-.005	-	-	0.127
D	.495	-.505	12.57	12.83	bbb	-.010	-	-	0.254
E	.035	-.045	0.89	1.14	ccc	-.015	-	-	0.381
F	.003	-.006	0.08	0.15	-	-	-	-	-
H	.057	-.067	1.45	1.7	-	-	-	-	-
K	.170	-.210	4.32	5.33	-	-	-	-	-
M	.774	-.786	19.61	20.02	-	-	-	-	-
N	.772	-.788	19.61	20.02	-	-	-	-	-
R	.365	-.375	9.27	9.53	-	-	-	-	-
S	.365	-.375	9.27	9.52	-	-	-	-	-

© FREESCALE SEMICONDUCTOR, INC. ALL RIGHTS RESERVED.	MECHANICAL OUTLINE	PRINT VERSION NOT TO SCALE
TITLE: NI-780S	DOCUMENT NO: 98ASB16718C	REV: H
	CASE NUMBER: 465A-06	31 MAR 2005
	STANDARD: NON-JEDEC	

PRODUCT DOCUMENTATION AND SOFTWARE

Refer to the following documents and software to aid your design process.

Application Notes

- AN1955: Thermal Measurement Methodology of RF Power Amplifiers

Engineering Bulletins

- EB212: Using Data Sheet Impedances for RF LDMOS Devices

Software

- Electromigration MTTF Calculator
- RF High Power Model

For Software, do a Part Number search at <http://www.freescale.com>, and select the “Part Number” link. Go to the Software & Tools tab on the part’s Product Summary page to download the respective tool.

REVISION HISTORY

The following table summarizes revisions to this document.

Revision	Date	Description
0	Jan. 2007	<ul style="list-style-type: none"> • Initial Release of Data Sheet
1	Dec. 2008	<ul style="list-style-type: none"> • Table 4, On Characteristics, corrected V_{DS} to V_{DD} in the RF test condition voltage callout for $V_{GS(Q)}$, p. 2 • Table 4, On Characteristics, tightened $V_{GS(Q)}$ max value from 3.8 to 3.5 to match production test value, p. 2 • Updated PCB information to show more specific material details, Figs. 1 and 17, Test Circuit Schematic, p. 4, 10 • Updated Part Numbers in Tables 5 and 6, Component Designations and Values, to latest RoHS compliant part numbers, p. 4, 10 • Updated Fig. 14, CCDF W-CDMA 3GPP, Test Model 1, 64 DPCH, 50% Clipping, Single-Carrier Test Signal, to better represent production test signal, p. 8
2	Mar. 2011	<ul style="list-style-type: none"> • Modified data sheet to reflect RF Test Reduction described in Product and Process Change Notification number, PCN13628, p. 1, 2 • Fig. 13, MTTF versus Junction Temperature removed, p. 8. Refer to the device’s MTTF Calculator available at freescale.com/RFpower. Go to Design Resources > Software and Tools. • Fig. 14, CCDF W-CDMA IQ Magnitude Clipping, Single-Carrier Test Signal and Fig. 15, Single-Carrier W-CDMA Spectrum updated to show the undistorted input test signal, p. 8 (renumbered as Figs. 13 and 14 respectively after Fig. 13 removed) • Added Electromigration MTTF Calculator and RF High Power Model availability to Product Software, p. 18

How to Reach Us:

Home Page:

www.freescale.com

Web Support:

<http://www.freescale.com/support>

USA/Europe or Locations Not Listed:

Freescale Semiconductor, Inc.
Technical Information Center, EL516
2100 East Elliot Road
Tempe, Arizona 85284
1-800-521-6274 or +1-480-768-2130
www.freescale.com/support

Europe, Middle East, and Africa:

Freescale Halbleiter Deutschland GmbH
Technical Information Center
Schatzbogen 7
81829 Muenchen, Germany
+44 1296 380 456 (English)
+46 8 52200080 (English)
+49 89 92103 559 (German)
+33 1 69 35 48 48 (French)
www.freescale.com/support

Japan:

Freescale Semiconductor Japan Ltd.
Headquarters
ARCO Tower 15F
1-8-1, Shimo-Meguro, Meguro-ku,
Tokyo 153-0064
Japan
0120 191014 or +81 3 5437 9125
support.japan@freescale.com

Asia/Pacific:

Freescale Semiconductor China Ltd.
Exchange Building 23F
No. 118 Jianguo Road
Chaoyang District
Beijing 100022
China
+86 10 5879 8000
support.asia@freescale.com

For Literature Requests Only:

Freescale Semiconductor Literature Distribution Center
1-800-441-2447 or +1-303-675-2140
Fax: +1-303-675-2150
LDCForFreescaleSemiconductor@hibbertgroup.com

Information in this document is provided solely to enable system and software implementers to use Freescale Semiconductor products. There are no express or implied copyright licenses granted hereunder to design or fabricate any integrated circuits or integrated circuits based on the information in this document.



Freescale Semiconductor reserves the right to make changes without further notice to any products herein. Freescale Semiconductor makes no warranty, representation or guarantee regarding the suitability of its products for any particular purpose, nor does Freescale Semiconductor assume any liability arising out of the application or use of any product or circuit, and specifically disclaims any and all liability, including without limitation consequential or incidental damages. "Typical" parameters that may be provided in Freescale Semiconductor data sheets and/or specifications can and do vary in different applications and actual performance may vary over time. All operating parameters, including "Typicals", must be validated for each customer application by customer's technical experts. Freescale Semiconductor does not convey any license under its patent rights nor the rights of others. Freescale Semiconductor products are not designed, intended, or authorized for use as components in systems intended for surgical implant into the body, or other applications intended to support or sustain life, or for any other application in which the failure of the Freescale Semiconductor product could create a situation where personal injury or death may occur. Should Buyer purchase or use Freescale Semiconductor products for any such unintended or unauthorized application, Buyer shall indemnify and hold Freescale Semiconductor and its officers, employees, subsidiaries, affiliates, and distributors harmless against all claims, costs, damages, and expenses, and reasonable attorney fees arising out of, directly or indirectly, any claim of personal injury or death associated with such unintended or unauthorized use, even if such claim alleges that Freescale Semiconductor was negligent regarding the design or manufacture of the part.

Freescale™ and the Freescale logo are trademarks of Freescale Semiconductor, Inc. All other product or service names are the property of their respective owners.

© Freescale Semiconductor, Inc. 2007-2008, 2011. All rights reserved.

Looking for pricing, stock, or lifecycle information?

Click below to explore more details on WIN SOURCE:

-  [View MRF7S19080HSR3 on WIN SOURCE](#)
-  [Freescale Semiconductor - NXP Information](#)

Optimize Your Supply Chain with WIN SOURCE Solutions

-  Global Sourcing Solution
-  Obsolete Management
-  Cost Control Management
-  Shortage Management
-  Alternative Solution
-  Excess Inventory Management