



**THE DATASHEET OF
MRF7S19100NBR1**



RF Power Field Effect Transistors

N-Channel Enhancement-Mode Lateral MOSFETs

Designed for CDMA base station applications with frequencies from 1930 to 1990 MHz. Suitable for CDMA and multicarrier amplifier applications. To be used in Class AB and Class C for PCN - PCS/cellular radio and WLL applications.

- Typical Single-Carrier W-CDMA Performance: $V_{DD} = 28$ Volts, $I_{DQ} = 1000$ mA, $P_{out} = 29$ Watts Avg., Full Frequency Band, 3GPP Test Model 1, 64 DPCH with 50% Clipping, Channel Bandwidth = 3.84 MHz, Input Signal PAR = 7.5 dB @ 0.01% Probability on CCDF.
Power Gain — 17.5 dB
Drain Efficiency — 30%
Device Output Signal PAR — 6.1 dB @ 0.01% Probability on CCDF
ACPR @ 5 MHz Offset — -38 dBc in 3.84 MHz Channel Bandwidth
- Capable of Handling 5:1 VSWR, @ 32 Vdc, 1960 MHz, 100 Watts CW Peak Tuned Output Power
- P_{out} @ 1 dB Compression Point ≥ 100 W CW

Features

- 100% PAR Tested for Guaranteed Output Power Capability
- Characterized with Series Equivalent Large-Signal Impedance Parameters
- Internally Matched for Ease of Use
- Integrated ESD Protection
- Designed for Digital Predistortion Error Correction Systems
- 225°C Capable Plastic Package
- RoHS Compliant
- In Tape and Reel. R1 Suffix = 500 Units per 44 mm, 13 inch Reel.

MRF7S19100NR1
MRF7S19100NBR1

1930-1990 MHz, 29 W AVG., 28 V
SINGLE W-CDMA
LATERAL N-CHANNEL
RF POWER MOSFETs

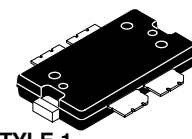

CASE 1486-03, STYLE 1
TO-270 WB-4
PLASTIC
MRF7S19100NR1

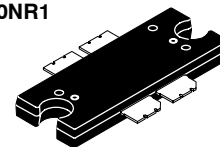

CASE 1484-04, STYLE 1
TO-272 WB-4
PLASTIC
MRF7S19100NBR1

Table 1. Maximum Ratings

| Rating | Symbol | Value | Unit |
|--------------------------------------|-----------|--------------|------|
| Drain-Source Voltage | V_{DSS} | -0.5, +65 | Vdc |
| Gate-Source Voltage | V_{GS} | -0.5, +10 | Vdc |
| Operating Voltage | V_{DD} | 32, +0 | Vdc |
| Storage Temperature Range | T_{stg} | - 65 to +200 | °C |
| Case Operating Temperature | T_C | 150 | °C |
| Operating Junction Temperature (1,2) | T_J | 225 | °C |

Table 2. Thermal Characteristics

| Characteristic | Symbol | Value (2,3) | Unit |
|---|-----------------|--------------|------|
| Thermal Resistance, Junction to Case Case Temperature 82°C, 100 W CW Case Temperature 79°C, 29 W CW | $R_{\theta JC}$ | 0.57 0.68 | °C/W |

1. Continuous use at maximum temperature will affect MTTF.
2. MTTF calculator available at <http://www.freescale.com/rf>. Select Software & Tools/Development Tools/Calculators to access MTTF calculators by product.
3. Refer to AN1955, *Thermal Measurement Methodology of RF Power Amplifiers*. Go to <http://www.freescale.com/rf>. Select Documentation/Application Notes - AN1955.

Table 3. ESD Protection Characteristics

| Test Methodology | Class |
|---------------------------------------|--------------|
| Human Body Model (per JESD22-A114) | 1C (Minimum) |
| Machine Model (per EIA/JESD22-A115) | A (Minimum) |
| Charge Device Model (per JESD22-C101) | IV (Minimum) |

Table 4. Moisture Sensitivity Level

| Test Methodology | Rating | Package Peak Temperature | Unit |
|---------------------------------------|--------|--------------------------|------|
| Per JESD 22-A113, IPC/JEDEC J-STD-020 | 3 | 260 | °C |

Table 5. Electrical Characteristics ($T_C = 25^\circ\text{C}$ unless otherwise noted)

| Characteristic | Symbol | Min | Typ | Max | Unit |
|----------------|--------|-----|-----|-----|------|
|----------------|--------|-----|-----|-----|------|

Off Characteristics

| | | | | | |
|---|-----------|---|---|-----|-----------------|
| Zero Gate Voltage Drain Leakage Current ($V_{DS} = 65 \text{ Vdc}$, $V_{GS} = 0 \text{ Vdc}$) | I_{DSS} | — | — | 10 | μAdc |
| Zero Gate Voltage Drain Leakage Current ($V_{DS} = 28 \text{ Vdc}$, $V_{GS} = 0 \text{ Vdc}$) | I_{DSS} | — | — | 1 | μAdc |
| Gate-Source Leakage Current ($V_{GS} = 5 \text{ Vdc}$, $V_{DS} = 0 \text{ Vdc}$) | I_{GSS} | — | — | 500 | nAdc |

On Characteristics

| | | | | | |
|---|--------------|-----|------|-----|-----|
| Gate Threshold Voltage ($V_{DS} = 10 \text{ Vdc}$, $I_D = 320 \mu\text{Adc}$) | $V_{GS(th)}$ | 1 | 2 | 3 | Vdc |
| Gate Quiescent Voltage ⁽¹⁾ ($V_{DD} = 28 \text{ Vdc}$, $I_D = 1000 \text{ mAdc}$, Measured in Functional Test) | $V_{GS(Q)}$ | 2 | 2.8 | 4 | Vdc |
| Drain-Source On-Voltage ($V_{GS} = 10 \text{ Vdc}$, $I_D = 3.2 \text{ Adc}$) | $V_{DS(on)}$ | 0.2 | 0.24 | 0.4 | Vdc |

Dynamic Characteristics ⁽²⁾

| | | | | | |
|--|-----------|---|-------|---|----|
| Reverse Transfer Capacitance ($V_{DS} = 28 \text{ Vdc} \pm 30 \text{ mV(rms)ac}$ @ 1 MHz, $V_{GS} = 0 \text{ Vdc}$) | C_{rss} | — | 1.54 | — | pF |
| Output Capacitance ($V_{DS} = 28 \text{ Vdc} \pm 30 \text{ mV(rms)ac}$ @ 1 MHz, $V_{GS} = 0 \text{ Vdc}$) | C_{oss} | — | 553.5 | — | pF |

Functional Tests (In Freescale Test Fixture, 50 ohm system) $V_{DD} = 28 \text{ Vdc}$, $I_{DQ} = 1000 \text{ mA}$, $P_{out} = 29 \text{ W Avg.}$, $f_1 = 1930 \text{ MHz}$, $f_2 = 1990 \text{ MHz}$, Single-Carrier W-CDMA, 3GPP Test Model 1, 64 DPCH, 50% Clipping, $PAR = 7.5 \text{ dB}$ @ 0.01% Probability on CCDF. ACPR measured in 3.84 MHz Channel Bandwidth @ $\pm 5 \text{ MHz}$ Offset.

| | | | | | |
|--|----------|------|------|------|-----|
| Power Gain | G_{ps} | 16.5 | 17.5 | 19.5 | dB |
| Drain Efficiency | η_D | 28.5 | 30 | — | % |
| Output Peak-to-Average Ratio @ 0.01% Probability on CCDF | PAR | 5.7 | 6.1 | — | dB |
| Adjacent Channel Power Ratio | ACPR | — | -38 | -36 | dBc |
| Input Return Loss | IRL | — | -12 | -10 | dB |

- $V_{GG} = 11/10 \times V_{GS(Q)}$. Parameter measured on Freescale Test Fixture, due to resistive divider network on the board. Refer to Test Circuit schematic.
- Part internally matched both on input and output.

(continued)

Table 5. Electrical Characteristics ($T_C = 25^\circ\text{C}$ unless otherwise noted) (continued)

| Characteristic | Symbol | Min | Typ | Max | Unit |
|---|------------------|-----|-------|-----|-----------------------|
| Typical Performances (In Freescale Test Fixture, 50 ohm system) $V_{DD} = 28\text{ Vdc}$, $I_{DQ} = 1000\text{ mA}$, 1930-1990 MHz Bandwidth | | | | | |
| Video Bandwidth @ 100 W PEP P_{out} where $IM3 = -30\text{ dBc}$ (Tone Spacing from 100 kHz to VBW) $\Delta IMD3 = IMD3 @ \text{VBW frequency} - IMD3 @ 100\text{ kHz} < 1\text{ dBc}$ (both sidebands) | VBW | — | 30 | — | MHz |
| Gain Flatness in 60 MHz Bandwidth @ $P_{out} = 29\text{ W Avg.}$ | G_F | — | 1 | — | dB |
| Average Group Delay @ $P_{out} = 100\text{ W CW}$, $f = 1960\text{ MHz}$ | Delay | — | 2.15 | — | ns |
| Part-to-Part Insertion Phase Variation @ $P_{out} = 100\text{ W CW}$, $f = 1960\text{ MHz}$, Six Sigma Window | $\Delta\Phi$ | — | 28.8 | — | $^\circ$ |
| Gain Variation over Temperature (-30°C to $+85^\circ\text{C}$) | ΔG | — | 0.019 | — | dB/ $^\circ\text{C}$ |
| Output Power Variation over Temperature (-30°C to $+85^\circ\text{C}$) | ΔP_{1dB} | — | 0.015 | — | dBm/ $^\circ\text{C}$ |

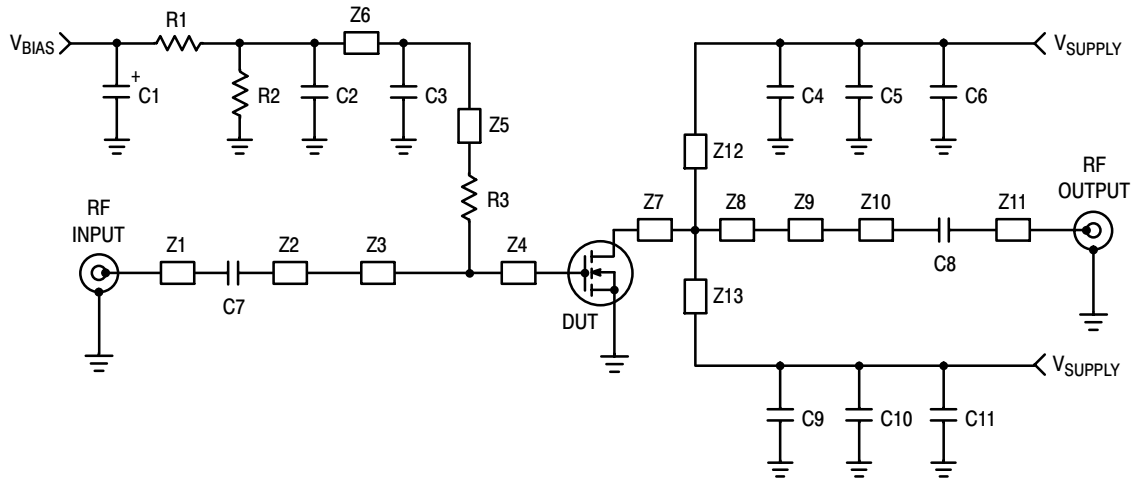

| | | | |
|----|----------------------------|----------|---|
| Z1 | 0.744" x 0.084" Microstrip | Z8 | 0.319" x 0.880" Microstrip |
| Z2 | 0.383" x 0.084" Microstrip | Z9 | 0.390" x 0.215" Microstrip |
| Z3 | 0.600" x 0.230" Microstrip | Z10 | 0.627" x 0.084" Microstrip |
| Z4 | 0.505" x 0.800" Microstrip | Z11 | 0.743" x 0.084" Microstrip |
| Z5 | 1.086" x 0.080" Microstrip | Z12, Z13 | 1.326" x 0.121" Microstrip |
| Z6 | 0.452" x 0.080" Microstrip | PCB | Arlon CuClad 250GX-0300-55-22, 0.030, $\epsilon_r = 2.55$ |
| Z7 | 0.161" x 0.880" Microstrip | | |

Figure 1. MRF7S19100NR1(NBR1) Test Circuit Schematic

Table 6. MRF7S19100NR1(NBR1) Test Circuit Component Designations and Values

| Part | Description | Part Number | Manufacturer |
|----------------------|-------------------------------------|--------------------|--------------|
| C1 | 10 μ F, 35 V Tantalum Capacitor | T491D106K035AT | Kemet |
| C2, C5, C6, C10, C11 | 10 μ F, 50 V Chip Capacitors | GRM55DR61H106KA88L | Murata |
| C3, C7 | 5.1 pF Chip Capacitors | ATC100B5R1BT500XT | ATC |
| C4, C9 | 8.2 pF Chip Capacitors | ATC100B8R2BT500XT | ATC |
| C8 | 10 pF Chip Capacitor | ATC100B100BT500XT | ATC |
| R1 | 1 K Ω , 1/4 W Chip Resistor | CRCW12061001FKEA | Vishay |
| R2 | 10 K Ω , 1/4 W Chip Resistor | CRCW12061002FKEA | Vishay |
| R3 | 10 Ω , 1/4 W Chip Resistor | CRCW120610R0FKEA | Vishay |

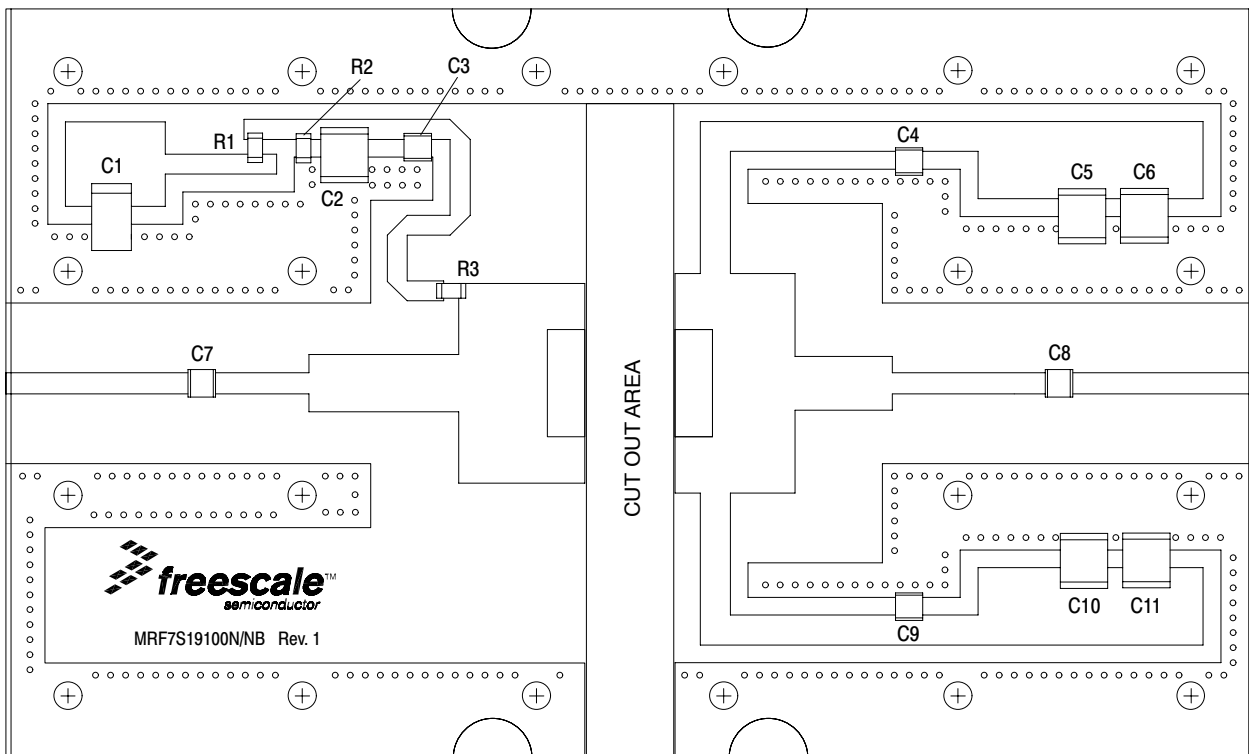

Figure 2. MRF7S19100NR1(NBR1) Test Circuit Component Layout

TYPICAL CHARACTERISTICS

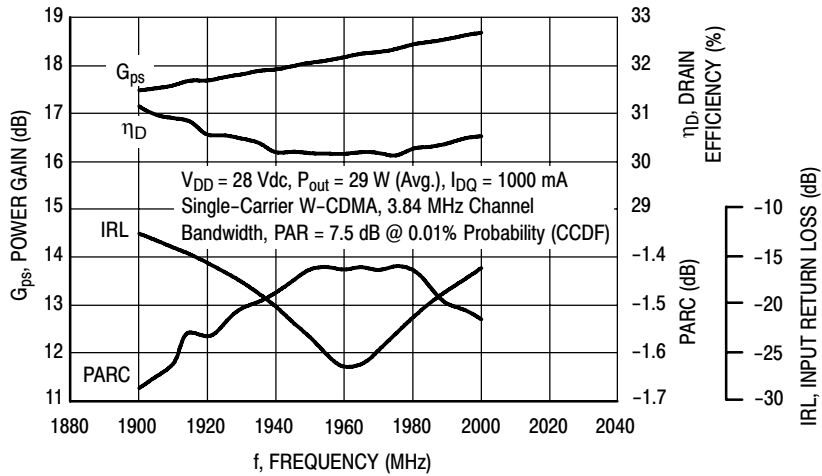

Figure 3. Output Peak-to-Average Ratio Compression (PARC) Broadband Performance @ $P_{out} = 29$ Watts Avg.

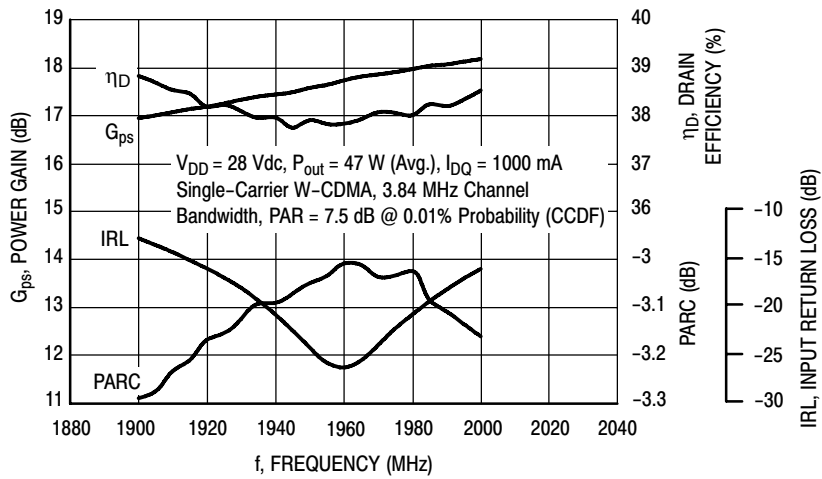

Figure 4. Output Peak-to-Average Ratio Compression (PARC) Broadband Performance @ $P_{out} = 47$ Watts Avg.

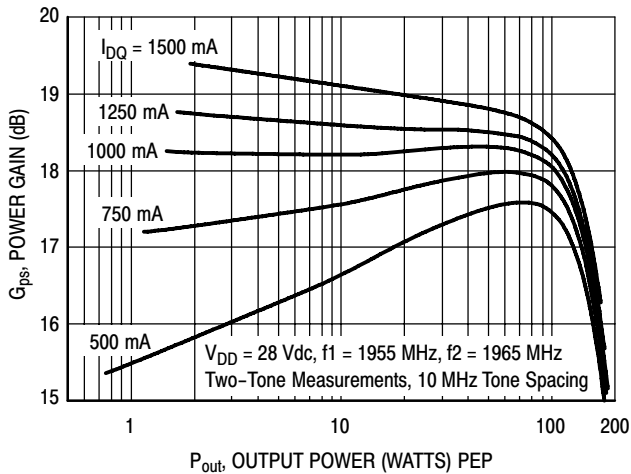

Figure 5. Two-Tone Power Gain versus Output Power

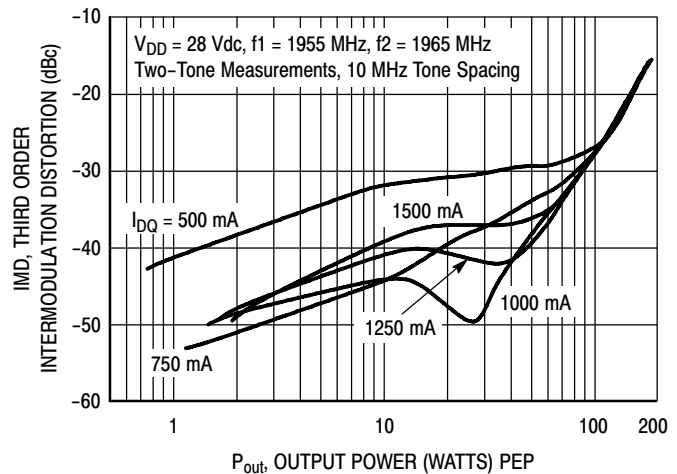

Figure 6. Third Order Intermodulation Distortion versus Output Power

TYPICAL CHARACTERISTICS

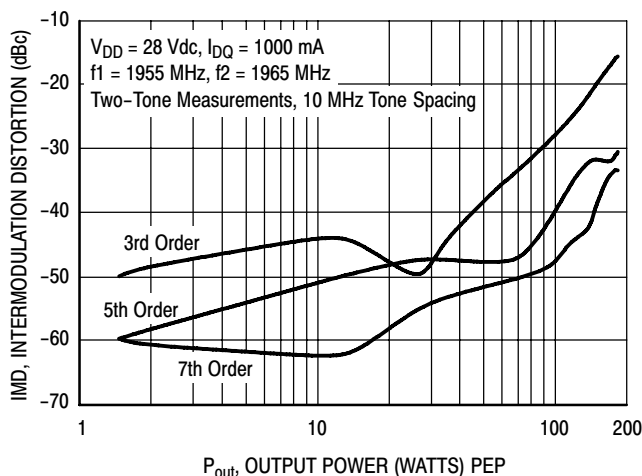

Figure 7. Intermodulation Distortion Products versus Output Power

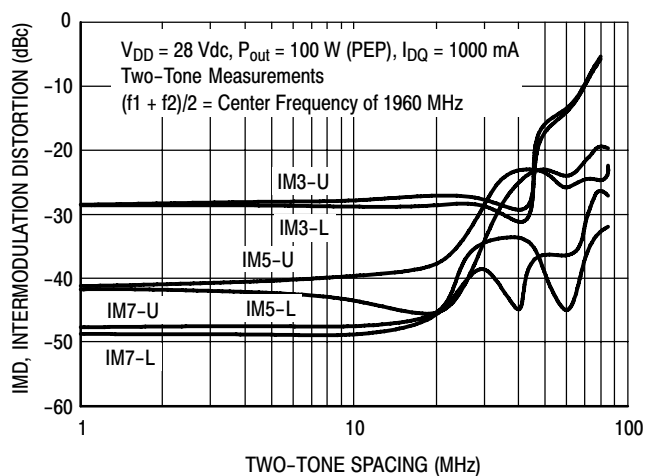

Figure 8. Intermodulation Distortion Products versus Tone Spacing

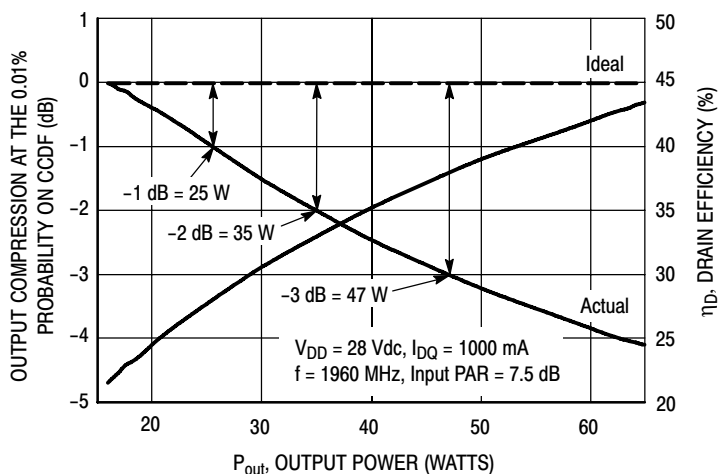

Figure 9. Output Peak-to-Average Ratio Compression (PARC) versus Output Power

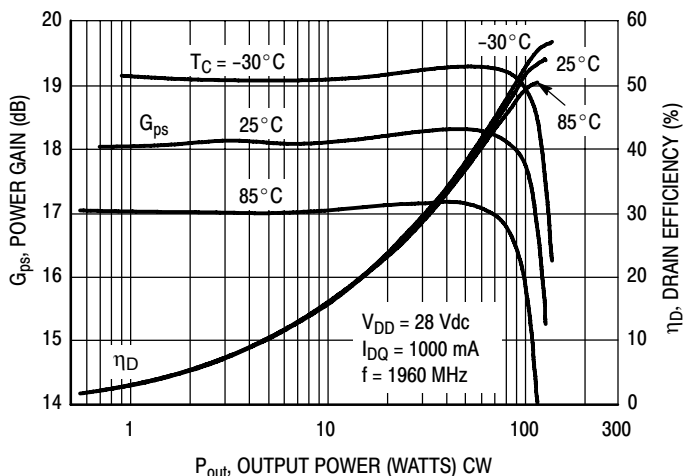

Figure 10. Power Gain and Drain Efficiency versus CW Output Power

TYPICAL CHARACTERISTICS

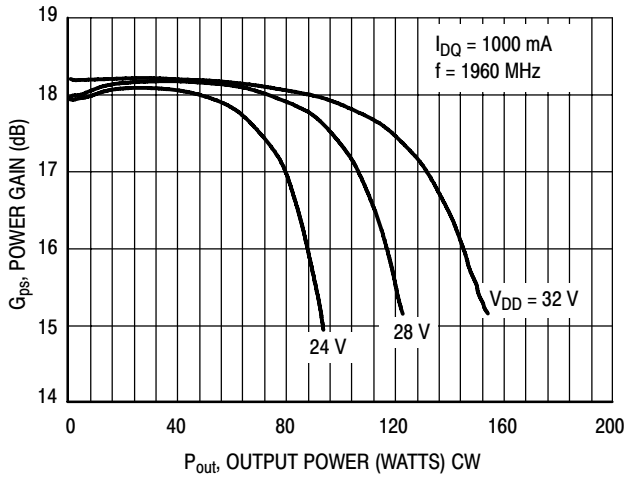
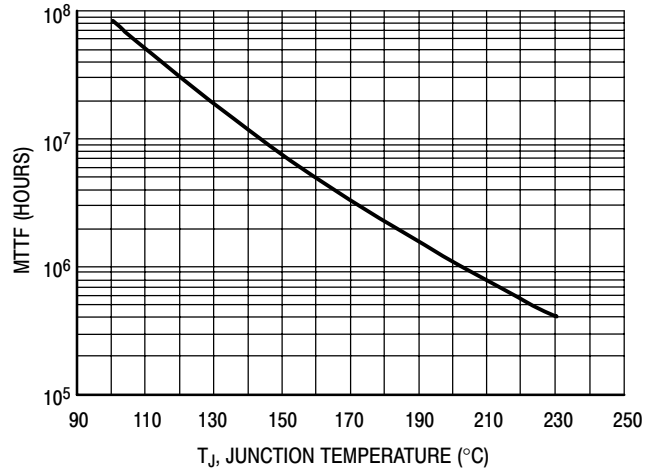

Figure 11. Power Gain versus Output Power



This above graph displays calculated MTTF in hours when the device is operated at $V_{DD} = 28 \text{ Vdc}$, $P_{out} = 29 \text{ W Avg.}$, and $\eta_D = 30\%$.

MTTF calculator available at <http://www.freescale.com/rf>. Select Software & Tools/Development Tools/Calculators to access MTTF calculators by product.

Figure 12. MTTF Factor versus Junction Temperature

W-CDMA TEST SIGNAL

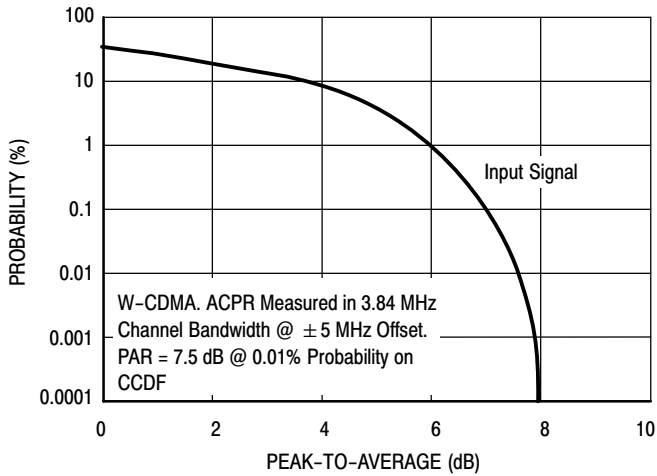

Figure 13. CCDF W-CDMA 3GPP, Test Model 1, 64 DPCH, 50% Clipping, Single-Carrier Test Signal

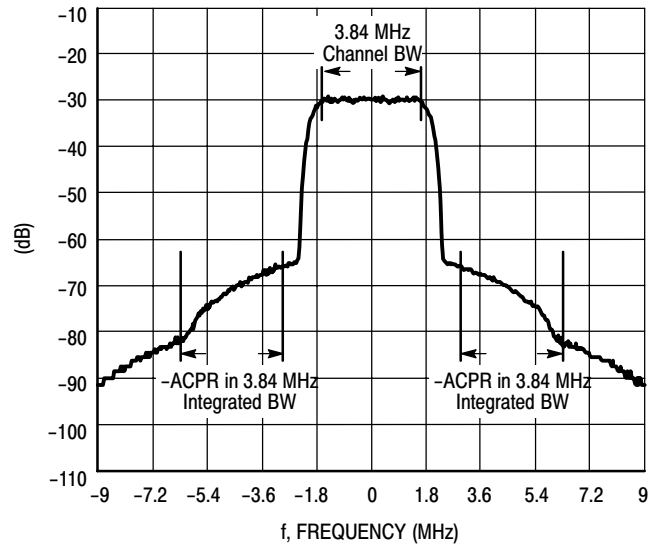
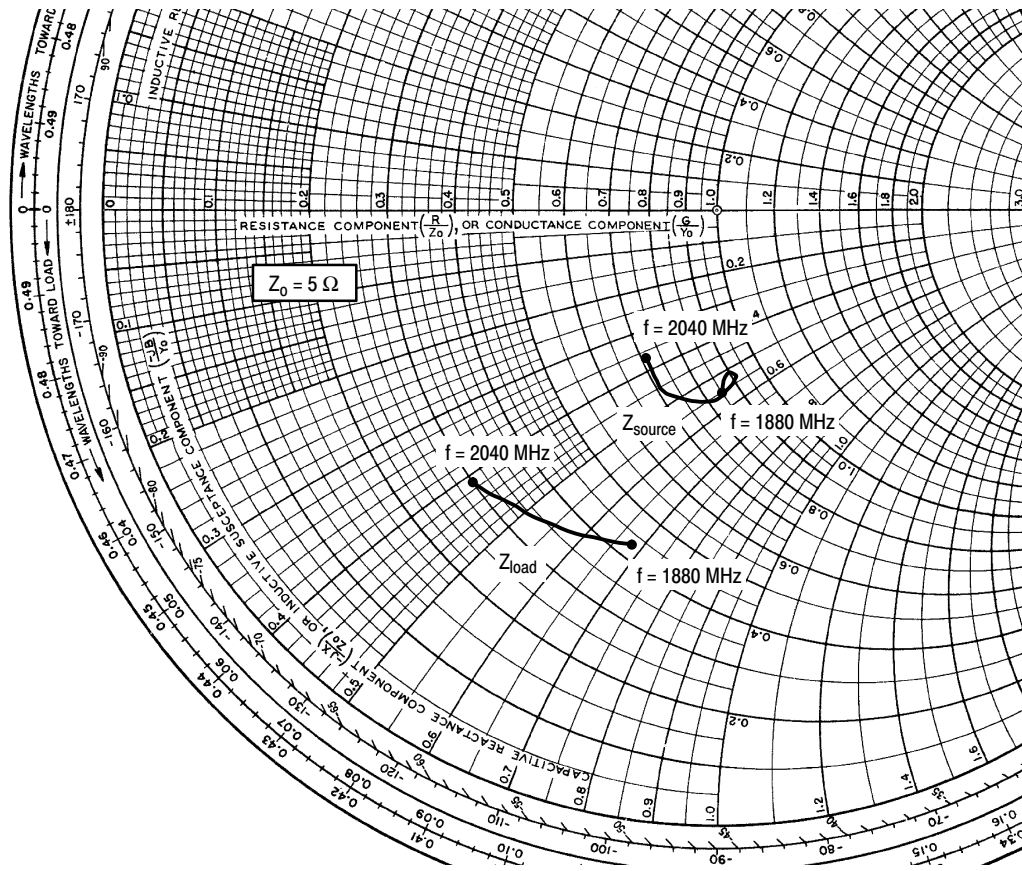

Figure 14. Single-Carrier W-CDMA Spectrum



$V_{DD} = 28 \text{ Vdc}$, $I_{DQ} = 1000 \text{ mA}$, $P_{out} = 29 \text{ W Avg.}$

| f MHz | Z_{source} Ω | Z_{load} Ω |
|----------|--------------------------|------------------------|
| 1880 | $4.257 - j2.758$ | $2.143 - j3.408$ |
| 1900 | $4.388 - j2.617$ | $2.038 - j3.236$ |
| 1920 | $4.521 - j2.560$ | $1.944 - j3.066$ |
| 1940 | $4.568 - j2.630$ | $1.858 - j2.898$ |
| 1960 | $4.424 - j2.758$ | $1.775 - j2.725$ |
| 1980 | $4.124 - j2.800$ | $1.708 - j2.550$ |
| 2000 | $3.819 - j2.611$ | $1.643 - j2.387$ |
| 2020 | $3.567 - j2.292$ | $1.572 - j2.223$ |
| 2040 | $3.525 - j1.844$ | $1.487 - j2.029$ |

Z_{source} = Test circuit impedance as measured from gate to ground.

Z_{load} = Test circuit impedance as measured from drain to ground.

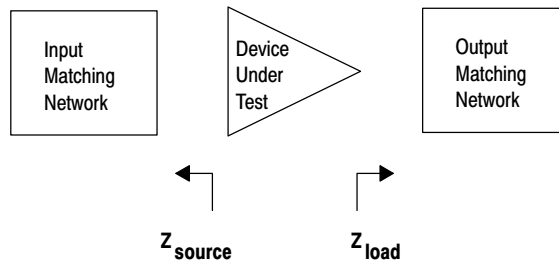
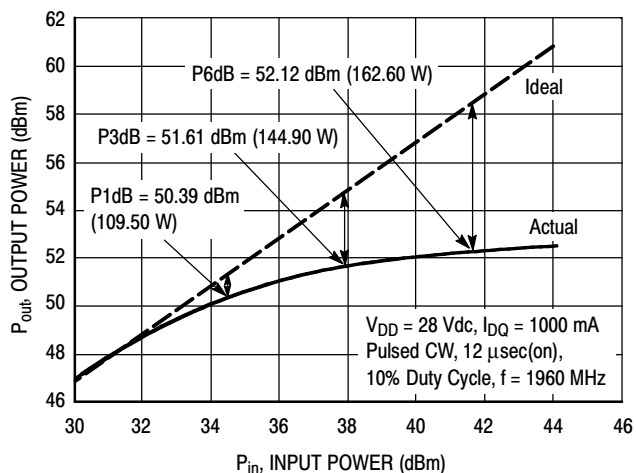

Figure 15. Series Equivalent Source and Load Impedance

ALTERNATIVE PEAK TUNE LOAD PULL CHARACTERISTICS



NOTE: Measured in a Peak Tuned Load Pull Fixture

Test Impedances per Compression Level

| | Z_{source} Ω | Z_{load} Ω |
|------|--------------------------|------------------------|
| P3dB | 4.39 - j5.66 | 1.81 - j3.27 |

Figure 16. Pulsed CW Output Power versus Input Power

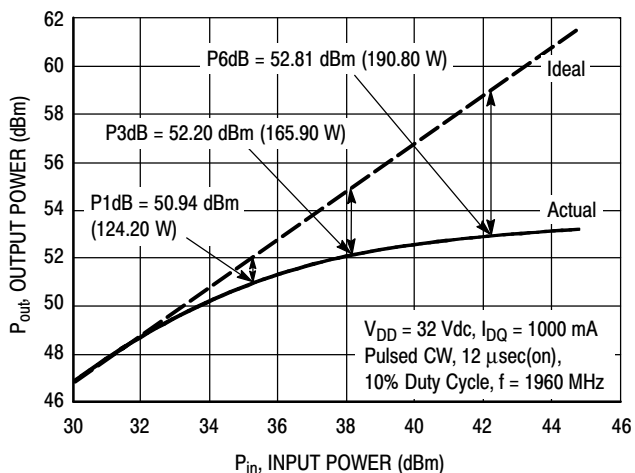

NOTE: Measured in a Peak Tuned Load Pull Fixture

Test Impedances per Compression Level

| | Z_{source} Ω | Z_{load} Ω |
|------|--------------------------|------------------------|
| P3dB | 4.39 - j5.66 | 1.81 - j3.27 |

Figure 17. Pulsed CW Output Power versus Input Power

PACKAGE DIMENSIONS

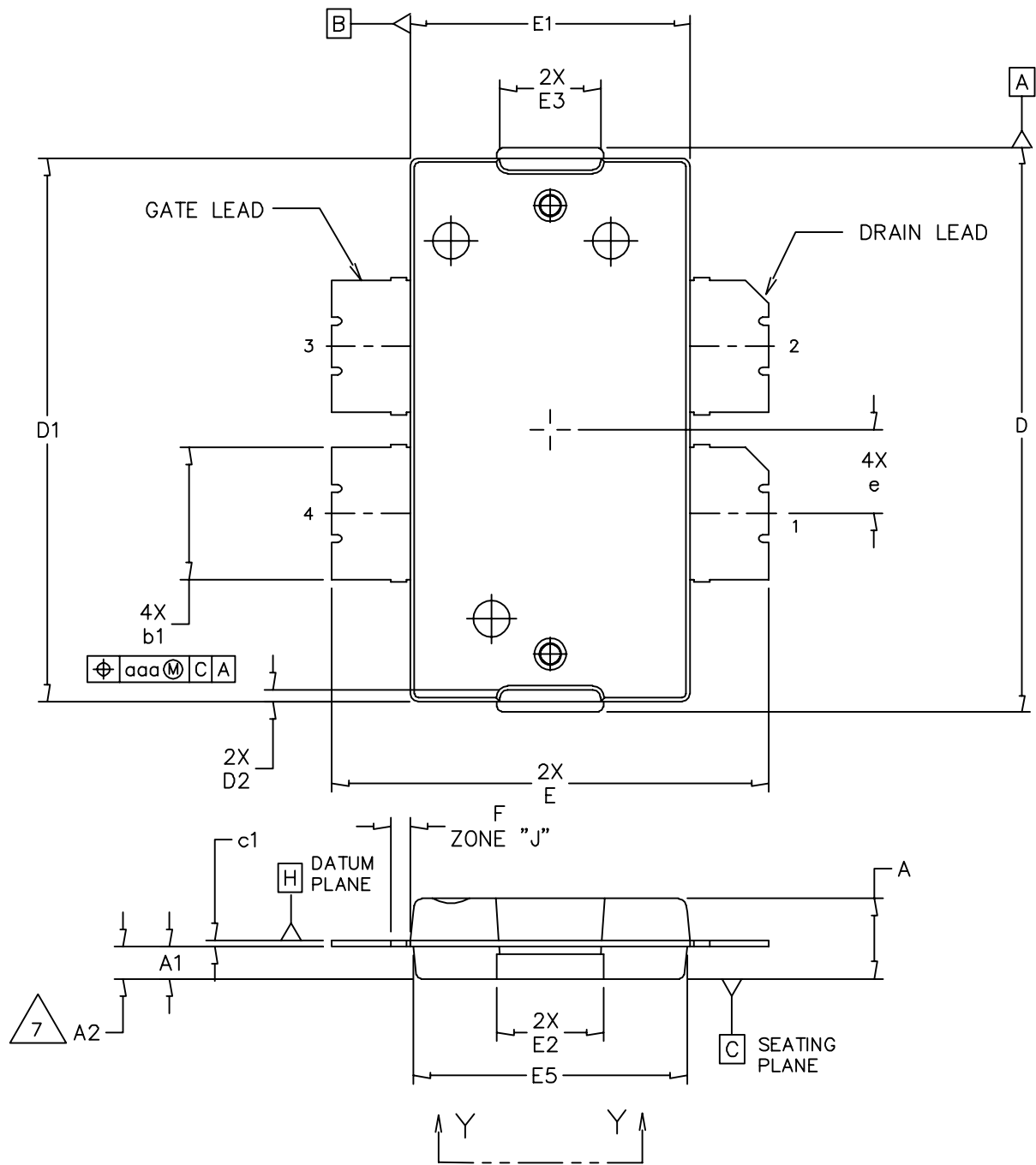

| | | | |
|---|--------------------------|----------------------------|--|
| © FREESCALE SEMICONDUCTOR, INC. ALL RIGHTS RESERVED. | MECHANICAL OUTLINE | PRINT VERSION NOT TO SCALE | |
| TITLE: TO-270 4 LEAD, WIDE BODY | DOCUMENT NO: 98ASA10577D | REV: D | |
| | CASE NUMBER: 1486-03 | 13 AUG 2007 | |
| | STANDARD: NON-JEDEC | | |

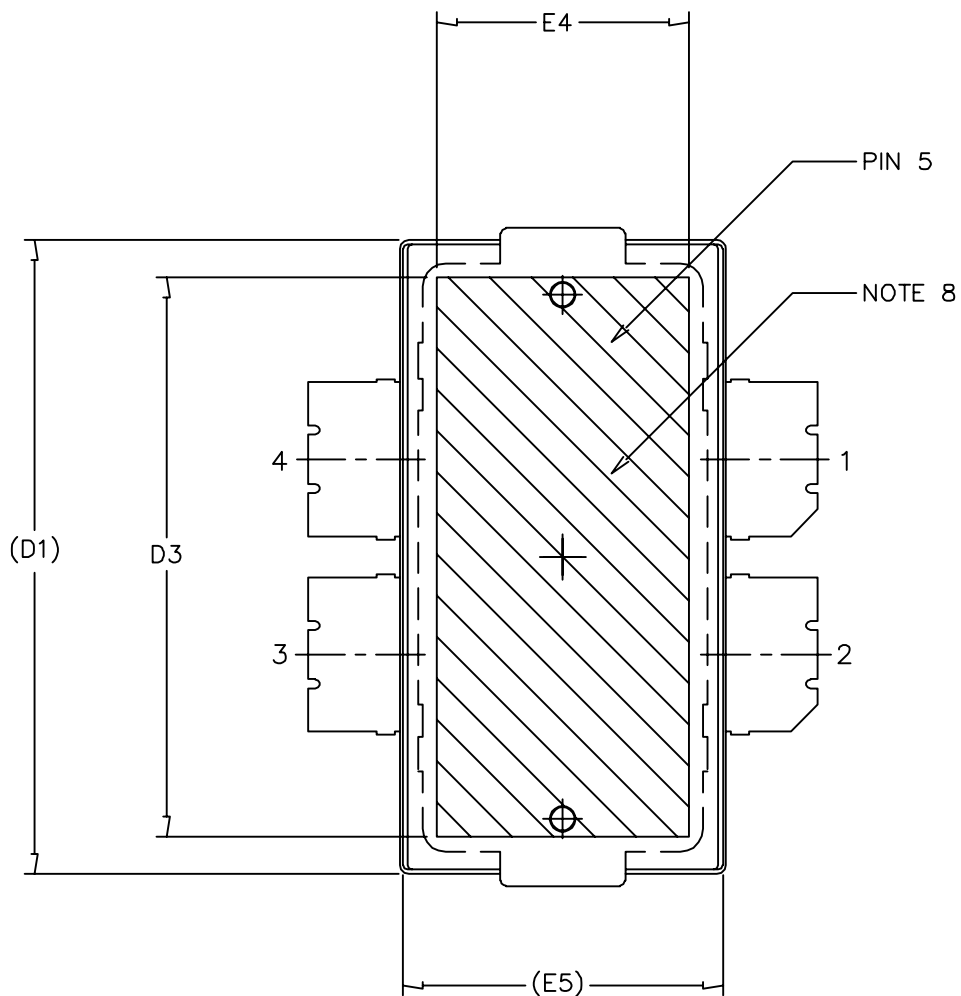

| | | | |
|---|--------------------|----------------------------|-------------|
| © FREESCALE SEMICONDUCTOR, INC. ALL RIGHTS RESERVED. | MECHANICAL OUTLINE | PRINT VERSION NOT TO SCALE | |
| TITLE: TO-270 4 LEAD, WIDE BODY | | DOCUMENT NO: 98ASA10577D | REV: D |
| | | CASE NUMBER: 1486-03 | 13 AUG 2007 |
| | | STANDARD: NON-JEDEC | |

NOTES:

1. CONTROLLING DIMENSION: INCH
2. INTERPRET DIMENSIONS AND TOLERANCES PER ASME Y14.5M-1994.
3. DATUM PLANE -H- IS LOCATED AT THE TOP OF LEAD AND IS COINCIDENT WITH THE LEAD WHERE THE LEAD EXITS THE PLASTIC BODY AT THE TOP OF THE PARTING LINE.
4. DIMENSIONS "D" AND "E1" DO NOT INCLUDE MOLD PROTRUSION. ALLOWABLE PROTRUSION IS .006 PER SIDE. DIMENSIONS "D" AND "E1" DO INCLUDE MOLD MISMATCH AND ARE DETERMINED AT DATUM PLANE -H-.
5. DIMENSIONS "b1" DOES NOT INCLUDE DAMBAR PROTRUSION. ALLOWABLE DAMBAR PROTRUSION SHALL BE .005 TOTAL IN EXCESS OF THE "b1" DIMENSION AT MAXIMUM MATERIAL CONDITION.
6. DATUMS -A- AND -B- TO BE DETERMINED AT DATUM PLANE -H-.
7. DIMENSION A2 APPLIES WITHIN ZONE "J" ONLY.
8. HATCHING REPRESENTS THE EXPOSED AREA OF THE HEAT SLUG.

STYLE 1:

PIN 1 - DRAIN PIN 2 - DRAIN
 PIN 3 - GATE PIN 4 - GATE
 PIN 5 - SOURCE

| DIM | INCH | | MILLIMETER | | DIM | INCH | | MILLIMETER | |
|---|------|------|--------------------|-------|--------------------------|----------------------------|------|-------------|------|
| | MIN | MAX | MIN | MAX | | MIN | MAX | MIN | MAX |
| A | .100 | .104 | 2.54 | 2.64 | F | .025 BSC | | 0.64 BSC | |
| A1 | .039 | .043 | 0.99 | 1.09 | b1 | .164 | .170 | 4.17 | 4.32 |
| A2 | .040 | .042 | 1.02 | 1.07 | c1 | .007 | .011 | .18 | .28 |
| D | .712 | .720 | 18.08 | 18.29 | e | .106 BSC | | 2.69 BSC | |
| D1 | .688 | .692 | 17.48 | 17.58 | aaa | .004 | | .10 | |
| D2 | .011 | .019 | 0.28 | 0.48 | | | | | |
| D3 | .600 | --- | 15.24 | --- | | | | | |
| E | .551 | .559 | 14 | 14.2 | | | | | |
| E1 | .353 | .357 | 8.97 | 9.07 | | | | | |
| E2 | .132 | .140 | 3.35 | 3.56 | | | | | |
| E3 | .124 | .132 | 3.15 | 3.35 | | | | | |
| E4 | .270 | --- | 6.86 | --- | | | | | |
| E5 | .346 | .350 | 8.79 | 8.89 | | | | | |
| © FREESCALE SEMICONDUCTOR, INC. ALL RIGHTS RESERVED. | | | MECHANICAL OUTLINE | | | PRINT VERSION NOT TO SCALE | | | |
| TITLE: TO-270 4 LEAD WIDE BODY | | | | | DOCUMENT NO: 98ASA10577D | | | REV: D | |
| | | | | | CASE NUMBER: 1486-03 | | | 13 AUG 2007 | |
| | | | | | STANDARD: NON-JEDEC | | | | |

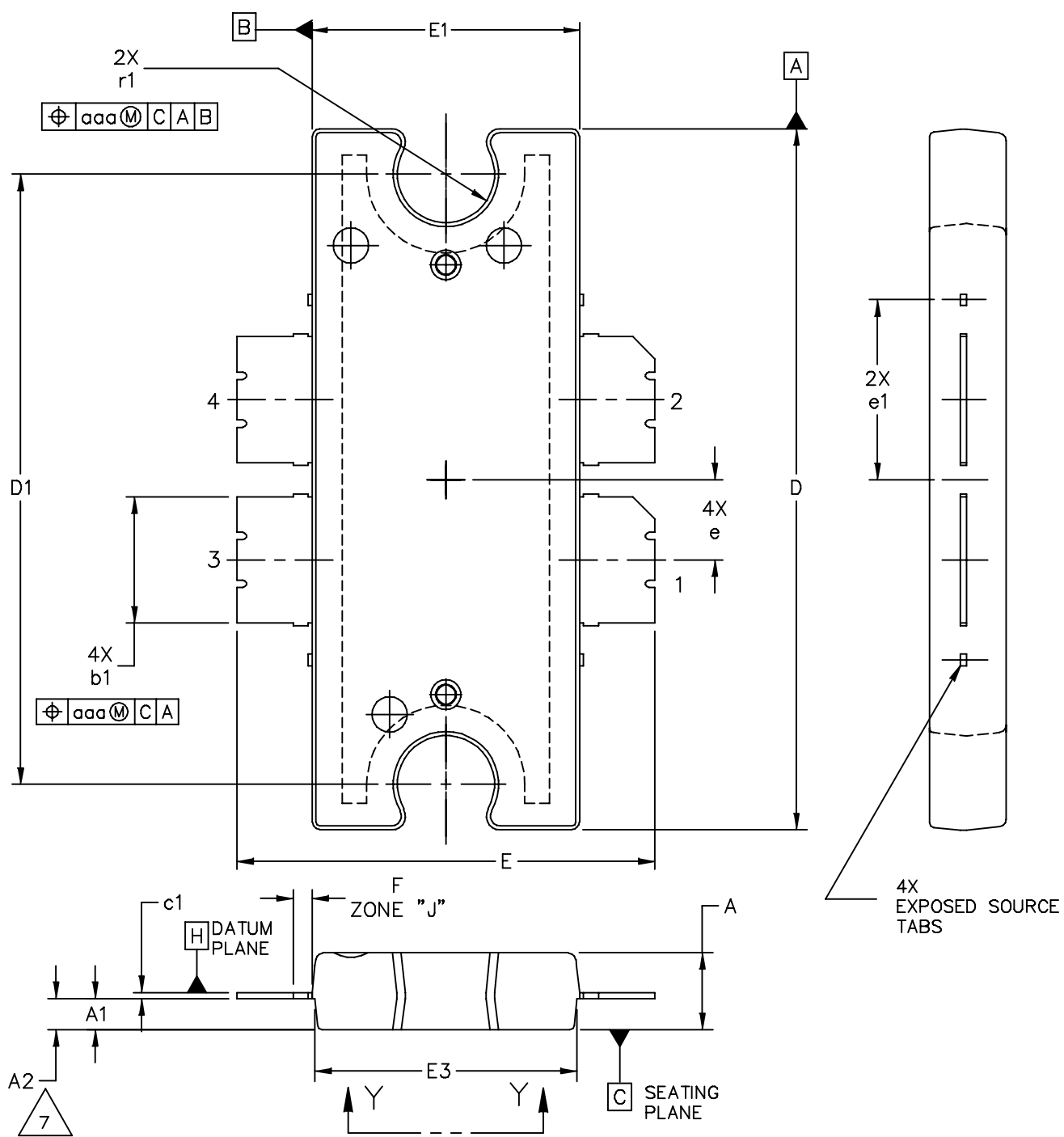

| | | | |
|---|--|--------------------------|----------------------------|
| © FREESCALE SEMICONDUCTOR, INC. ALL RIGHTS RESERVED. | | MECHANICAL OUTLINE | PRINT VERSION NOT TO SCALE |
| TITLE: TO-272 4 LEAD, WIDE BODY | | DOCUMENT NO: 98ASA10575D | REV: E |
| | | CASE NUMBER: 1484-04 | 31 AUG 2007 |
| | | STANDARD: NON-JEDEC | |

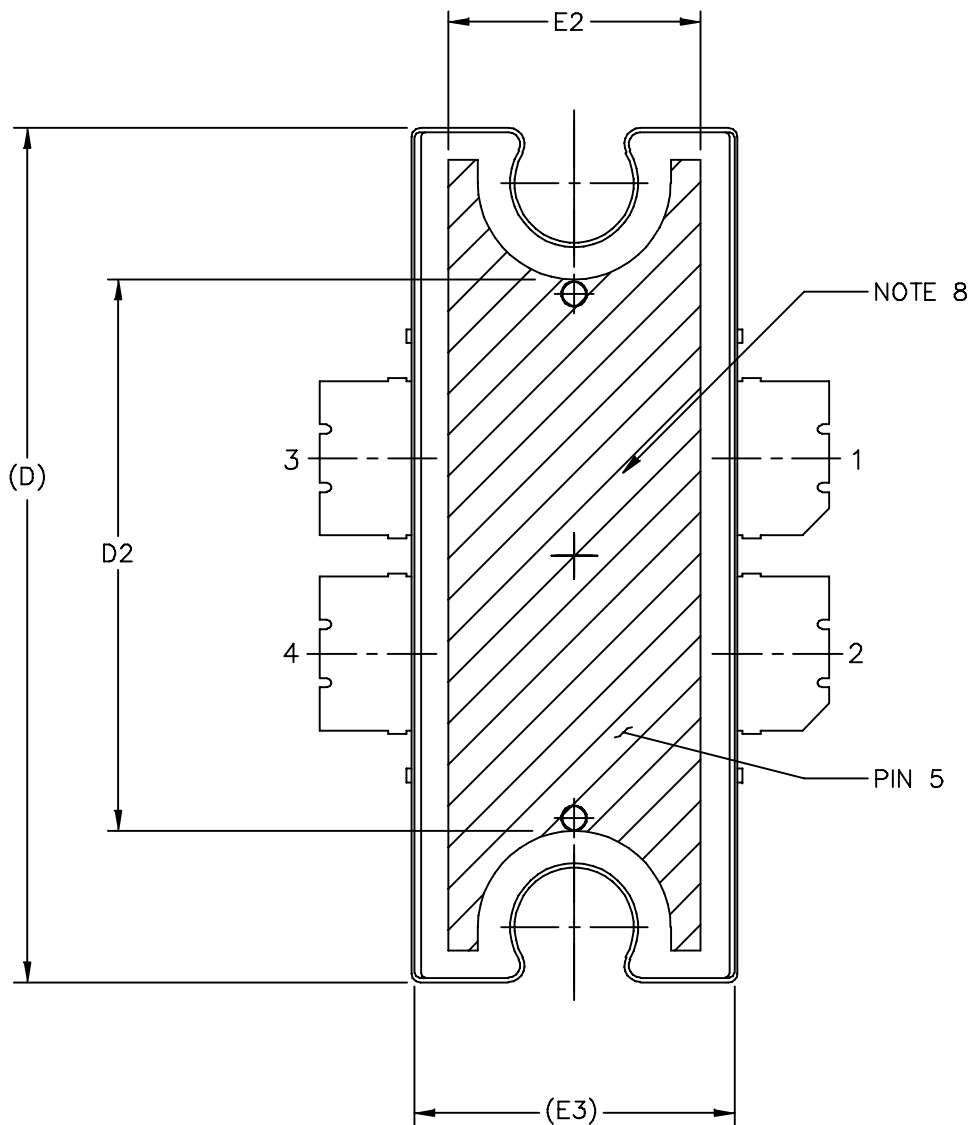

| | | | |
|---|--------------------|----------------------------|-------------|
| © FREESCALE SEMICONDUCTOR, INC. ALL RIGHTS RESERVED. | MECHANICAL OUTLINE | PRINT VERSION NOT TO SCALE | |
| TITLE: TO-272 4 LEAD, WIDE BODY | | DOCUMENT NO: 98ASA10575D | REV: E |
| | | CASE NUMBER: 1484-04 | 31 AUG 2007 |
| | | STANDARD: NON-JEDEC | |

NOTES:

1. CONTROLLING DIMENSION: INCH
2. INTERPRET DIMENSIONS AND TOLERANCES PER ASME Y14.5M-1994.
3. DATUM PLANE H IS LOCATED AT THE TOP OF LEAD AND IS COINCIDENT WITH THE LEAD WHERE THE LEAD EXITS THE PLASTIC BODY AT THE TOP OF THE PARTING LINE.
4. DIMENSIONS "D" AND "E1" DO NOT INCLUDE MOLD PROTRUSION. ALLOWABLE PROTRUSION IS .006 PER SIDE. DIMENSIONS "D" AND "E1" DO INCLUDE MOLD MISMATCH AND ARE DETERMINED AT DATUM PLANE H.
5. DIMENSIONS "b1" DOES NOT INCLUDE DAMBAR PROTRUSION. ALLOWABLE DAMBAR PROTRUSION SHALL BE .005 TOTAL IN EXCESS OF THE "b1" DIMENSION AT MAXIMUM MATERIAL CONDITION.
6. DATUM A AND B TO BE DETERMINED AT DATUM PLANE H.
7. DIMENSION A2 APPLIES WITHIN ZONE "J" ONLY.
8. HATCHING REPRESENTS EXPOSED AREA OF THE HEAT SLUG. HATCHED AREA SHOWN IS ON THE SAME PLANE.

STYLE 1:

PIN 1 - DRAIN PIN 2 - DRAIN
 PIN 3 - GATE PIN 4 - GATE
 PIN 5 - SOURCE

| DIM | INCH | | MILLIMETER | | DIM | INCH | | MILLIMETER | |
|-----|----------|------|------------|-------|-----|----------------|------|----------------|------|
| | MIN | MAX | MIN | MAX | | MIN | MAX | MIN | MAX |
| A | .100 | .104 | 2.54 | 2.64 | b1 | .164 | .170 | 4.17 | 4.32 |
| A1 | .039 | .043 | 0.99 | 1.09 | c1 | .007 | .011 | .18 | .28 |
| A2 | .040 | .042 | 1.02 | 1.07 | r1 | .063 | .068 | 1.60 | 1.73 |
| D | .928 | .932 | 23.57 | 23.67 | e | .106 BSC | | 2.69 BSC | |
| D1 | .810 BSC | | 20.57 BSC | | e1 | .239 INFO ONLY | | 6.07 INFO ONLY | |
| D2 | .600 | --- | 15.24 | --- | aaa | .004 | | .10 | |
| E | .551 | .559 | 14 | 14.2 | | | | | |
| E1 | .353 | .357 | 8.97 | 9.07 | | | | | |
| E2 | .270 | --- | 6.86 | --- | | | | | |
| E3 | .346 | .350 | 8.79 | 8.89 | | | | | |
| F | .025 BSC | | 0.64 BSC | | | | | | |

| | | | |
|---|--------------------------|--------------------|----------------------------|
| © FREESCALE SEMICONDUCTOR, INC. ALL RIGHTS RESERVED. | | MECHANICAL OUTLINE | PRINT VERSION NOT TO SCALE |
| TITLE: TO-272 4 LEAD WIDE BODY | DOCUMENT NO: 98ASA10575D | | REV: E |
| | CASE NUMBER: 1484-04 | | 31 AUG 2007 |
| | STANDARD: NON-JEDEC | | |

PRODUCT DOCUMENTATION

Refer to the following documents to aid your design process.

Application Notes

- AN1907: Solder Reflow Attach Method for High Power RF Devices in Plastic Packages
- AN1955: Thermal Measurement Methodology of RF Power Amplifiers
- AN3263: Bolt Down Mounting Method for High Power RF Transistors and RFICs in Over-Molded Plastic Packages

Engineering Bulletins

- EB212: Using Data Sheet Impedances for RF LDMOS Devices

REVISION HISTORY

The following table summarizes revisions to this document.

| Revision | Date | Description |
|----------|-----------|---|
| 3 | Jan. 2008 | <ul style="list-style-type: none"> • Added Case Operating Temperature limit to the Maximum Ratings table and set limit to 150°C, p. 1 • Operating Junction Temperature increased from 200°C to 225°C in Maximum Ratings table, related “Continuous use at maximum temperature will affect MTTF” footnote added and changed 200°C to 225°C in Capable Plastic Package bullet, p. 1 • Corrected V_{DS} to V_{DD} in the RF test condition voltage callout for $V_{GS(Q)}$, On Characteristics table, p. 2 • Updated Typical Performance table to provide better definition of characterization attributes, p. 3 • Updated PCB information to show more specific material details, Fig. 1, Test Circuit Schematic, p. 4 • Updated Part Numbers in Table 6, Component Designations and Values, to latest RoHS compliant part numbers, p. 4 • Adjusted scale for Fig. 8, Intermodulation Distortion Products versus Tone Spacing, to better match the device’s capabilities, p. 7 • Replaced Fig. 12, MTTF versus Junction Temperature with updated graph. Removed Amps² and listed operating characteristics and location of MTTF calculator for device, p. 8 • Updated Fig. 13, CCDF W-CDMA 3GPP, Test Model 1, 64 DPCH, 50% Clipping, Single-Carrier Test Signal, to better represent production test signal, p. 8 • Replaced Case Outline 1486-03, Issue C, with 1486-03, Issue D, p.11-13. Added pin numbers 1 through 4 on Sheet 1. • Replaced Case Outline 1484-04, Issue D, with 1484-04, Issue E, p. 14-16. Added pin numbers 1 through 4 on Sheet 1, replacing Gate and Drain notations with Pin 1 and Pin 2 designations. • Added Product Documentation and Revision History, p. 17 |

How to Reach Us:

Home Page:

www.freescale.com

Web Support:

<http://www.freescale.com/support>

USA/Europe or Locations Not Listed:

Freescale Semiconductor, Inc.
 Technical Information Center, EL516
 2100 East Elliot Road
 Tempe, Arizona 85284
 1-800-521-6274 or +1-480-768-2130
www.freescale.com/support

Europe, Middle East, and Africa:

Freescale Halbleiter Deutschland GmbH
 Technical Information Center
 Schatzbogen 7
 81829 Muenchen, Germany
 +44 1296 380 456 (English)
 +46 8 52200080 (English)
 +49 89 92103 559 (German)
 +33 1 69 35 48 48 (French)
www.freescale.com/support

Japan:

Freescale Semiconductor Japan Ltd.
 Headquarters
 ARCO Tower 15F
 1-8-1, Shimo-Meguro, Meguro-ku,
 Tokyo 153-0064
 Japan
 0120 191014 or +81 3 5437 9125
support.japan@freescale.com

Asia/Pacific:

Freescale Semiconductor China Ltd.
 Exchange Building 23F
 No. 118 Jianguo Road
 Chaoyang District
 Beijing 100022
 China
 +86 10 5879 8000
support.asia@freescale.com

For Literature Requests Only:

Freescale Semiconductor Literature Distribution Center
 P.O. Box 5405
 Denver, Colorado 80217
 1-800-441-2447 or +1-303-675-2140
 Fax: +1-303-675-2150
LDCForFreescaleSemiconductor@hibbertgroup.com

Information in this document is provided solely to enable system and software implementers to use Freescale Semiconductor products. There are no express or implied copyright licenses granted hereunder to design or fabricate any integrated circuits or integrated circuits based on the information in this document.

Freescale Semiconductor reserves the right to make changes without further notice to any products herein. Freescale Semiconductor makes no warranty, representation or guarantee regarding the suitability of its products for any particular purpose, nor does Freescale Semiconductor assume any liability arising out of the application or use of any product or circuit, and specifically disclaims any and all liability, including without limitation consequential or incidental damages. "Typical" parameters that may be provided in Freescale Semiconductor data sheets and/or specifications can and do vary in different applications and actual performance may vary over time. All operating parameters, including "Typicals", must be validated for each customer application by customer's technical experts. Freescale Semiconductor does not convey any license under its patent rights nor the rights of others. Freescale Semiconductor products are not designed, intended, or authorized for use as components in systems intended for surgical implant into the body, or other applications intended to support or sustain life, or for any other application in which the failure of the Freescale Semiconductor product could create a situation where personal injury or death may occur. Should Buyer purchase or use Freescale Semiconductor products for any such unintended or unauthorized application, Buyer shall indemnify and hold Freescale Semiconductor and its officers, employees, subsidiaries, affiliates, and distributors harmless against all claims, costs, damages, and expenses, and reasonable attorney fees arising out of, directly or indirectly, any claim of personal injury or death associated with such unintended or unauthorized use, even if such claim alleges that Freescale Semiconductor was negligent regarding the design or manufacture of the part.

Freescale™ and the Freescale logo are trademarks of Freescale Semiconductor, Inc. All other product or service names are the property of their respective owners.

© Freescale Semiconductor, Inc. 2006, 2008. All rights reserved.

Looking for pricing, stock, or lifecycle information?

Click below to explore more details on WIN SOURCE:

- ⊖ [View MRF7S19100NBR1 on WIN SOURCE](#)
- ⊖ [Freescale Semiconductor - NXP Information](#)

Optimize Your Supply Chain with WIN SOURCE Solutions

- ✓ Global Sourcing Solution
- ✓ Obsolete Management
- ✓ Cost Control Management
- ✓ Shortage Management
- ✓ Alternative Solution
- ✓ Excess Inventory Management