



**THE DATASHEET OF
MRF7S21170HR3**



RF Power Field Effect Transistors

N-Channel Enhancement-Mode Lateral MOSFETs

Designed for CDMA base station applications with frequencies from 2110 to 2170 MHz. Suitable for CDMA and multicarrier amplifier applications. To be used in Class AB and Class C for PCN-PCS/cellular radio and WLL applications.

- Typical Single-Carrier W-CDMA Performance: $V_{DD} = 28$ Volts, $I_{DQ} = 1400$ mA, $P_{out} = 50$ Watts Avg., $f = 2167.5$ MHz, IQ Magnitude Clipping, Channel Bandwidth = 3.84 MHz, Input Signal PAR = 7.5 dB @ 0.01% Probability on CCDF.
Power Gain — 16 dB
Drain Efficiency — 31%
Device Output Signal PAR — 6.1 dB @ 0.01% Probability on CCDF
ACPR @ 5 MHz Offset — -37 dBc in 3.84 MHz Channel Bandwidth
- Capable of Handling 5:1 VSWR, @ 32 Vdc, 2140 MHz, 170 Watts CW Output Power
- P_{out} @ 1 dB Compression Point ≈ 170 Watts CW

Features

- 100% PAR Tested for Guaranteed Output Power Capability
- Characterized with Series Equivalent Large-Signal Impedance Parameters
- Internally Matched for Ease of Use
- Integrated ESD Protection
- Greater Negative Gate-Source Voltage Range for Improved Class C Operation
- Optimized for Doherty Applications
- In Tape and Reel. R3 Suffix = 250 Units, 56 mm Tape Width, 13 inch Reel.

MRF7S21170HR3
MRF7S21170HSR3

2110-2170 MHz, 50 W AVG., 28 V
SINGLE W-CDMA
LATERAL N-CHANNEL
RF POWER MOSFETS

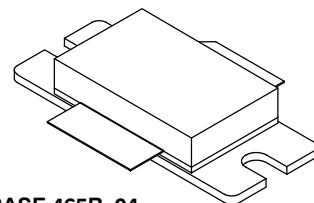

CASE 465B-04
NI-880
MRF7S21170HR3

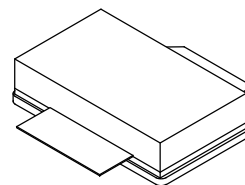

CASE 465C-03
NI-880S
MRF7S21170HSR3

Table 1. Maximum Ratings

Rating	Symbol	Value	Unit
Drain-Source Voltage	V_{DSS}	-0.5, +65	Vdc
Gate-Source Voltage	V_{GS}	-6.0, +10	Vdc
Operating Voltage	V_{DD}	32, +0	Vdc
Storage Temperature Range	T_{stg}	-65 to +150	°C
Case Operating Temperature	T_C	150	°C
Operating Junction Temperature (1,2)	T_J	225	°C

Table 2. Thermal Characteristics

Characteristic	Symbol	Value (2,3)	Unit
Thermal Resistance, Junction to Case Case Temperature 80°C, 170 W CW Case Temperature 73°C, 25 W CW	$R_{\theta JC}$	0.31 0.36	°C/W

1. Continuous use at maximum temperature will affect MTTF.
2. MTTF calculator available at <http://www.freescale.com/rf>. Select Software & Tools/Development Tools/Calculators to access MTTF calculators by product.
3. Refer to AN1955, *Thermal Measurement Methodology of RF Power Amplifiers*. Go to <http://www.freescale.com/rf>. Select Documentation/Application Notes - AN1955.

Table 3. ESD Protection Characteristics

Test Methodology	Class
Human Body Model (per JESD22-A114)	1A
Machine Model (per EIA/JESD22-A115)	B
Charge Device Model (per JESD22-C101)	IV

Table 4. Electrical Characteristics ($T_A = 25^\circ\text{C}$ unless otherwise noted)

Characteristic	Symbol	Min	Typ	Max	Unit
----------------	--------	-----	-----	-----	------

Off Characteristics

Zero Gate Voltage Drain Leakage Current ($V_{DS} = 65\text{ Vdc}$, $V_{GS} = 0\text{ Vdc}$)	I_{DSS}	—	—	10	μAdc
Zero Gate Voltage Drain Leakage Current ($V_{DS} = 28\text{ Vdc}$, $V_{GS} = 0\text{ Vdc}$)	I_{DSS}	—	—	1	μAdc
Gate-Source Leakage Current ($V_{GS} = 5\text{ Vdc}$, $V_{DS} = 0\text{ Vdc}$)	I_{GSS}	—	—	500	nAdc

On Characteristics

Gate Threshold Voltage ($V_{DS} = 10\text{ Vdc}$, $I_D = 372\ \mu\text{Adc}$)	$V_{GS(th)}$	1.2	2	2.7	Vdc
Gate Quiescent Voltage ($V_{DS} = 28\text{ Vdc}$, $I_D = 1400\ \text{mAdc}$)	$V_{GS(Q)}$	—	2.7	—	Vdc
Fixture Gate Quiescent Voltage (1) ($V_{DD} = 28\text{ Vdc}$, $I_D = 1400\ \text{mAdc}$, Measured in Functional Test)	$V_{GG(Q)}$	4.5	5.4	6.5	Vdc
Drain-Source On-Voltage ($V_{GS} = 10\text{ Vdc}$, $I_D = 3.72\ \text{Adc}$)	$V_{DS(on)}$	0.1	0.15	0.3	Vdc

Dynamic Characteristics (2)

Reverse Transfer Capacitance ($V_{DS} = 28\text{ Vdc} \pm 30\ \text{mV(rms)ac}$ @ 1 MHz, $V_{GS} = 0\text{ Vdc}$)	C_{rss}	—	0.9	—	pF
Output Capacitance ($V_{DS} = 28\text{ Vdc} \pm 30\ \text{mV(rms)ac}$ @ 1 MHz, $V_{GS} = 0\text{ Vdc}$)	C_{oss}	—	703	—	pF

Functional Tests (In Freescale Test Fixture, 50 ohm system) $V_{DD} = 28\text{ Vdc}$, $I_{DQ} = 1400\ \text{mA}$, $P_{out} = 50\ \text{W Avg.}$, $f = 2167.5\ \text{MHz}$, Single-Carrier W-CDMA, IQ Magnitude Clipping, Input Signal PAR = 7.5 dB @ 0.01% Probability on CCDF. ACPR measured in 3.84 MHz Channel Bandwidth @ $\pm 5\ \text{MHz}$ Offset.

Power Gain	G_{ps}	15	16	18	dB
Drain Efficiency	η_D	29	31	—	%
Output Peak-to-Average Ratio @ 0.01% Probability on CCDF	PAR	5.7	6.1	—	dB
Adjacent Channel Power Ratio	ACPR	—	-37	-35	dBc
Input Return Loss	IRL	—	-15	-9	dB

1. Continuous use at maximum temperature will affect MTTF.
2. MTTF calculator available at <http://www.freescale.com/rf>. Select Software & Tools/Development Tools/Calculators to access MTTF calculators by product.

(continued)

Table 4. Electrical Characteristics ($T_A = 25^\circ\text{C}$ unless otherwise noted) (continued)

Characteristic	Symbol	Min	Typ	Max	Unit
Typical Performances (In Freescale Test Fixture, 50 ohm system) $V_{DD} = 28\text{ Vdc}$, $I_{DQ} = 1400\text{ mA}$, 2110–2170 MHz Bandwidth					
Video Bandwidth @ 170 W PEP P_{out} where $IM3 = -30\text{ dBc}$ (Tone Spacing from 100 kHz to VBW) $\Delta IMD3 = IMD3 @ \text{VBW frequency} - IMD3 @ 100\text{ kHz} < 1\text{ dBc}$ (both sidebands)	VBW	—	25	—	MHz
Gain Flatness in 60 MHz Bandwidth @ $P_{out} = 50\text{ W Avg.}$	G_F	—	0.4	—	dB
Average Deviation from Linear Phase in 60 MHz Bandwidth @ $P_{out} = 170\text{ W CW}$	Φ	—	1.95	—	°
Average Group Delay @ $P_{out} = 170\text{ W CW}$, $f = 2140\text{ MHz}$	Delay	—	1.7	—	ns
Part-to-Part Insertion Phase Variation @ $P_{out} = 170\text{ W CW}$ $f = 2140\text{ MHz}$, Six Sigma Window	$\Delta\Phi$	—	18	—	°
Gain Variation over Temperature (-30°C to $+85^\circ\text{C}$)	ΔG	—	0.015	—	dB/°C
Output Power Variation over Temperature (-30°C to $+85^\circ\text{C}$)	ΔP_{1dB}	—	0.01	—	dB/°C

- $V_{GG} = 2 \times V_{GS(Q)}$. Parameter measured on Freescale Test Fixture, due to resistive divider network on the board. Refer to Test Circuit schematic.
- Part internally matched both on input and output.

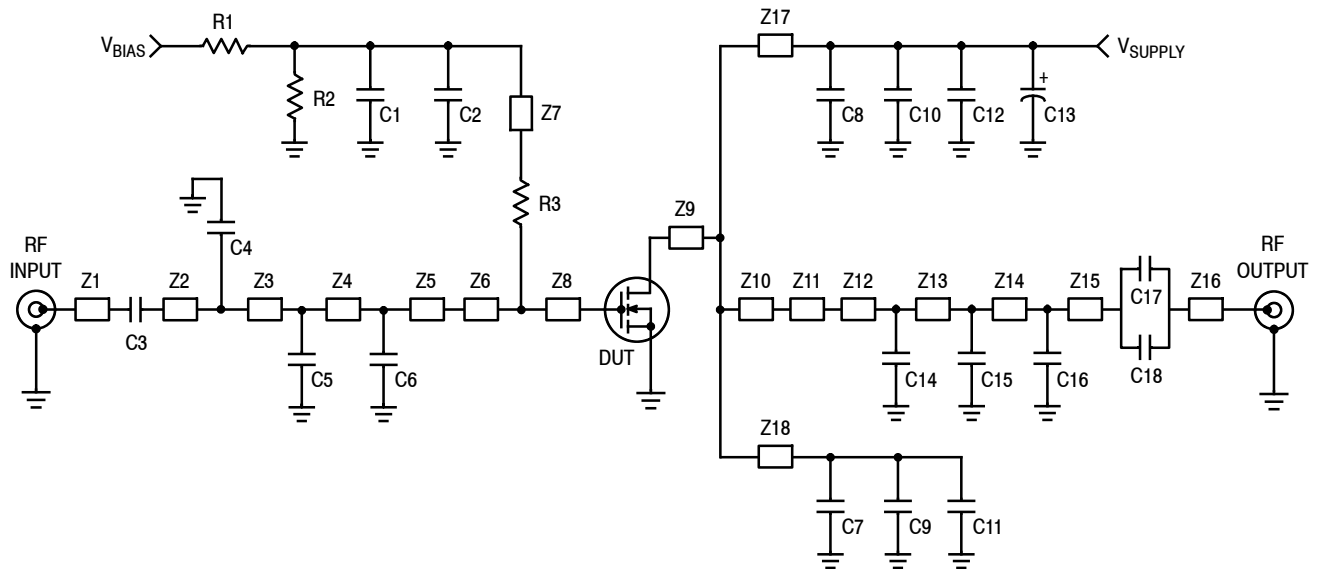

Z1	0.250" x 0.083" Microstrip	Z11	0.060" x 0.760" Microstrip
Z2*	0.090" x 0.083" Microstrip	Z12*	0.129" x 0.083" Microstrip
Z3*	0.842" x 0.083" Microstrip	Z13*	0.436" x 0.083" Microstrip
Z4*	0.379" x 0.083" Microstrip	Z14*	0.490" x 0.083" Microstrip
Z5*	0.307" x 0.083" Microstrip	Z15*	0.275" x 0.083" Microstrip
Z6	0.156" x 0.787" Microstrip	Z16	0.230" x 0.083" Microstrip
Z7	1.160" x 0.080" Microstrip	Z17, Z18	0.900" x 0.080" Microstrip
Z8	0.119" x 0.787" Microstrip	PCB	Taconic TLX8-0300, 0.030", $\epsilon_r = 2.55$
Z9	0.077" x 0.880" Microstrip		
Z10	0.459" x 1.000" Microstrip		

* Variable for tuning

Figure 1. MRF7S21170HR3(HSR3) Test Circuit Schematic

Table 5. MRF7S21170HR3(HSR3) Test Circuit Component Designations and Values

Part	Description	Part Number	Manufacturer
C1	100 pF Chip Capacitor	ATC100B101JT500XT	ATC
C2, C3, C7, C8, C17, C18	6.8 pF Chip Capacitors	ATC100B6R8BT500XT	ATC
C4, C15	0.3 pF Chip Capacitors	ATC100B0R3BT500XT	ATC
C5	0.8 pF Chip Capacitor	ATC100B0R8BT500XT	ATC
C6	0.2 pF Chip Capacitor	ATC100B0R2BT500XT	ATC
C9, C10, C11, C12	10 μ F Chip Capacitors	C5750X5R1H106MT	TDK
C13	470 μ F, 63 V Electrolytic Capacitor, Radial	477KXM063M	Illinois Capacitor
C14	0.4 pF Chip Capacitor	ATC100B0R4BT500XT	ATC
C16	0.1 pF Chip Capacitor	ATC100B0R1BT500XT	ATC
R1, R2	10 k Ω , 1/4 W Chip Resistors	CRCW12061002FKEA	Vishay
R3	10 Ω , 1/4 W Chip Resistor	CRCW120610R0FKEA	Vishay

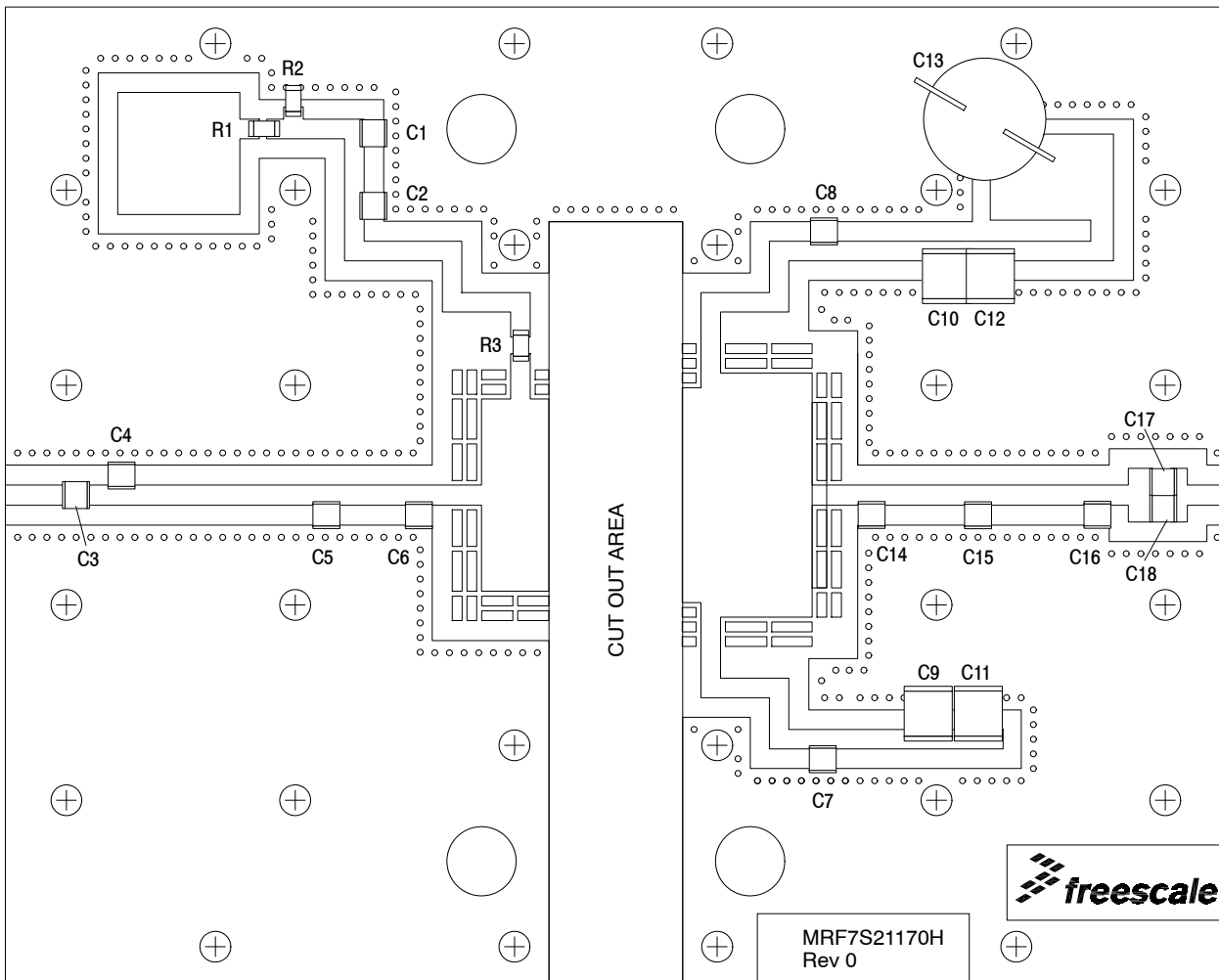

Figure 2. MRF7S21170HR3(HSR3) Test Circuit Component Layout

TYPICAL CHARACTERISTICS

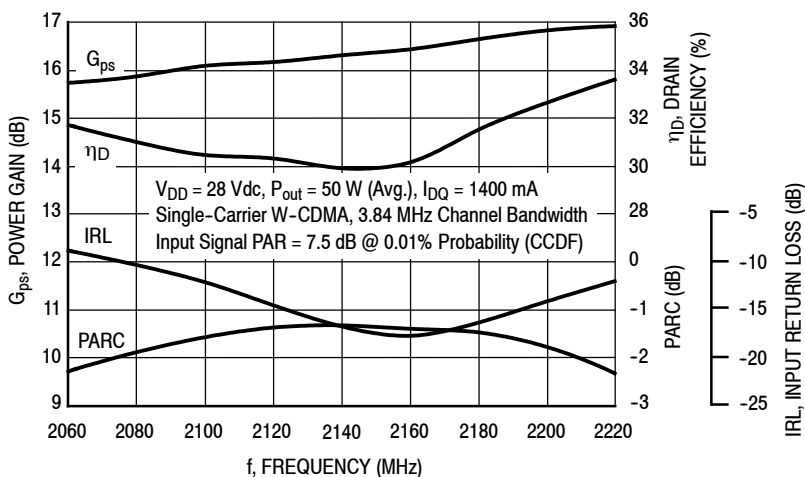

Figure 3. Output Peak-to-Average Ratio Compression (PARC) Broadband Performance @ $P_{out} = 50$ Watts Avg.

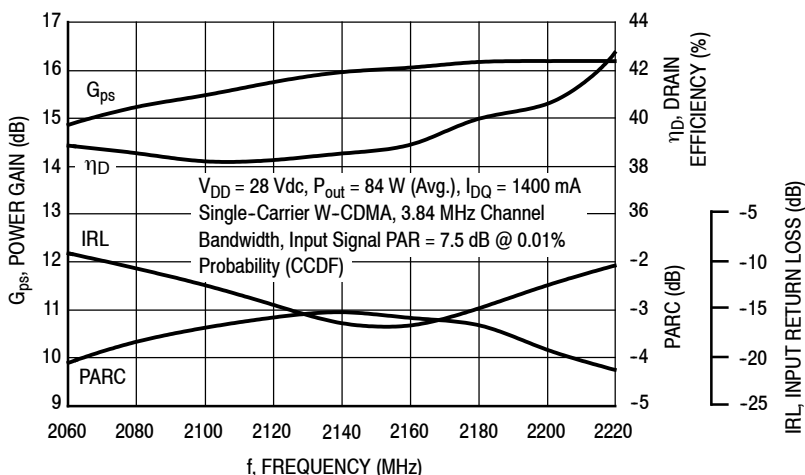

Figure 4. Output Peak-to-Average Ratio Compression (PARC) Broadband Performance @ $P_{out} = 84$ Watts Avg.

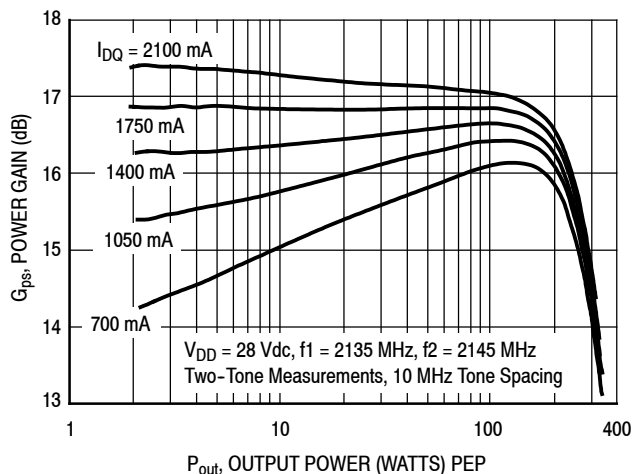

Figure 5. Two-Tone Power Gain versus Output Power

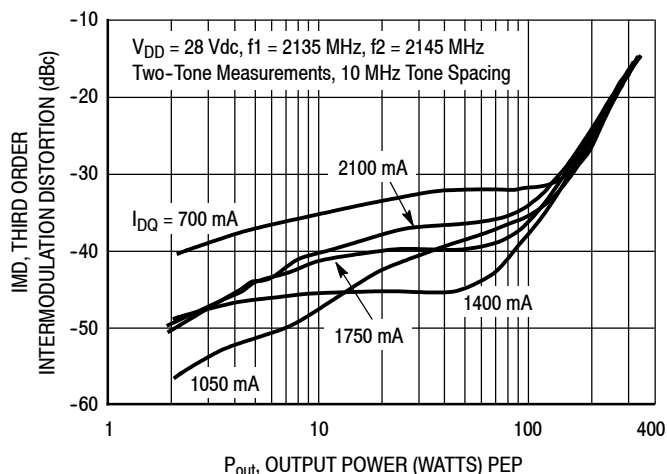

Figure 6. Third Order Intermodulation Distortion versus Output Power

TYPICAL CHARACTERISTICS

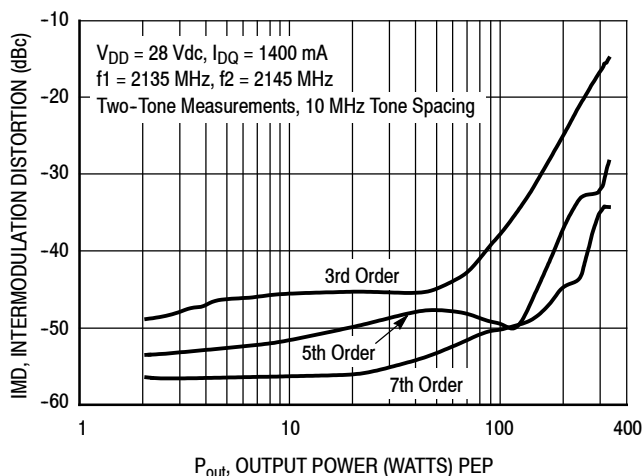

Figure 7. Intermodulation Distortion Products versus Output Power

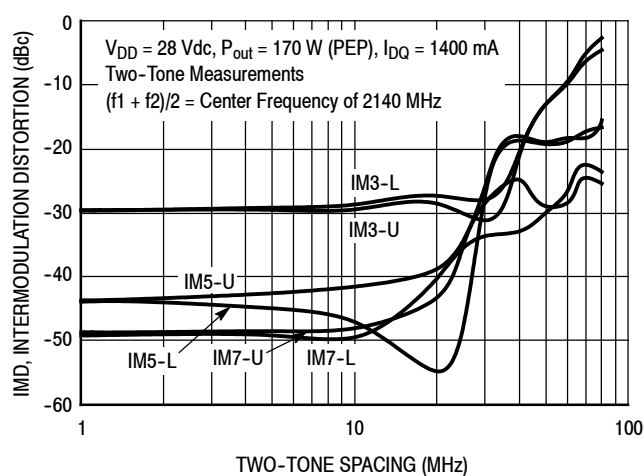

Figure 8. Intermodulation Distortion Products versus Tone Spacing

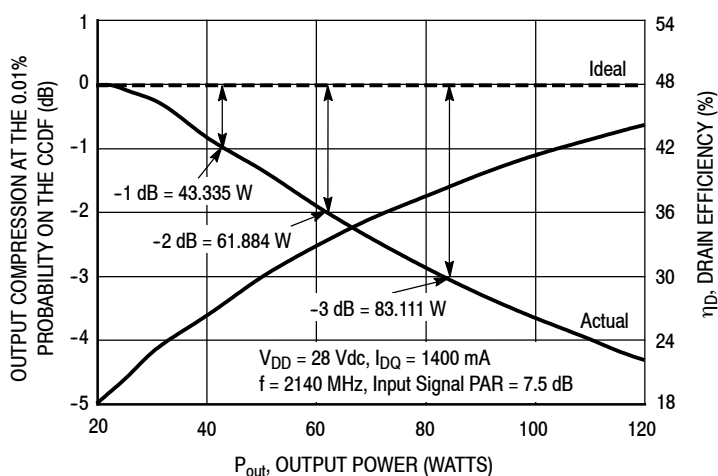

Figure 9. Output Peak-to-Average Ratio Compression (PARC) versus Output Power

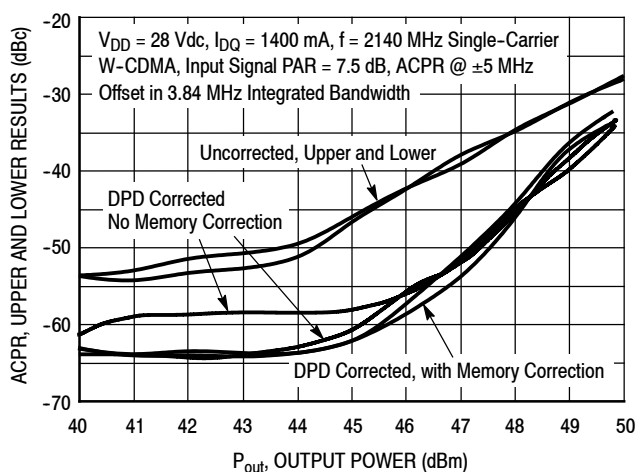

Figure 10. Digital Predistortion Correction versus ACPR and Output Power

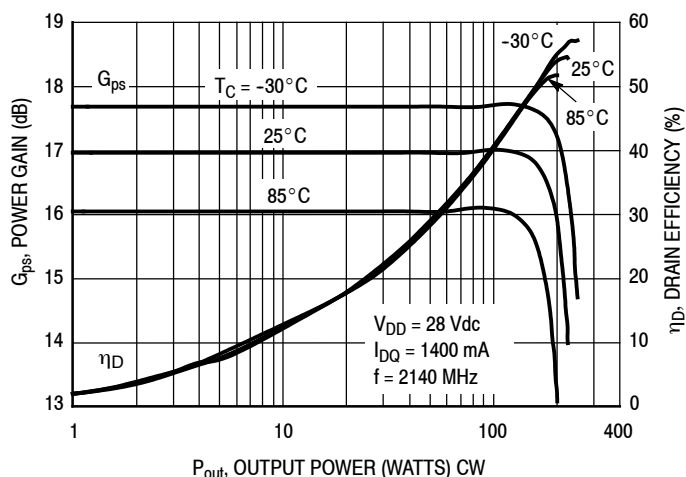

Figure 11. Power Gain and Drain Efficiency versus CW Output Power

TYPICAL CHARACTERISTICS

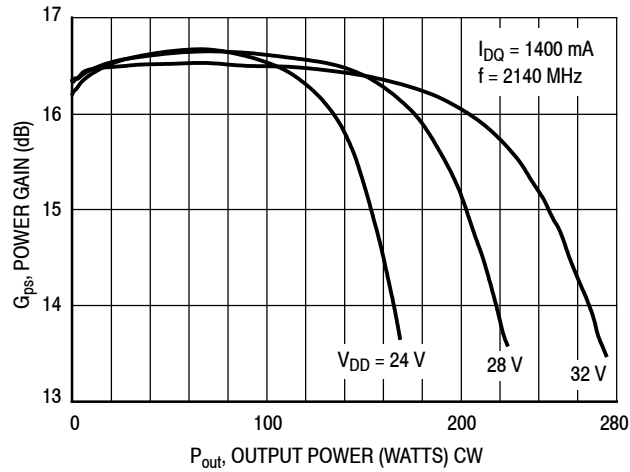

Figure 12. Power Gain versus Output Power

W-CDMA TEST SIGNAL

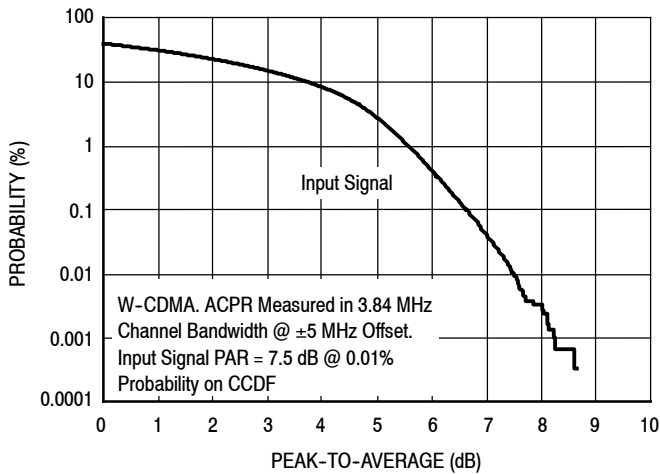

Figure 13. CCDF W-CDMA IQ Magnitude Clipping, Single-Carrier Test Signal

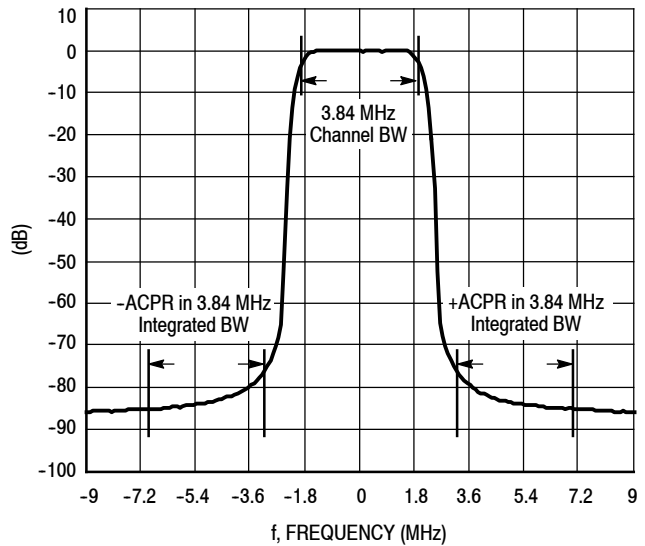
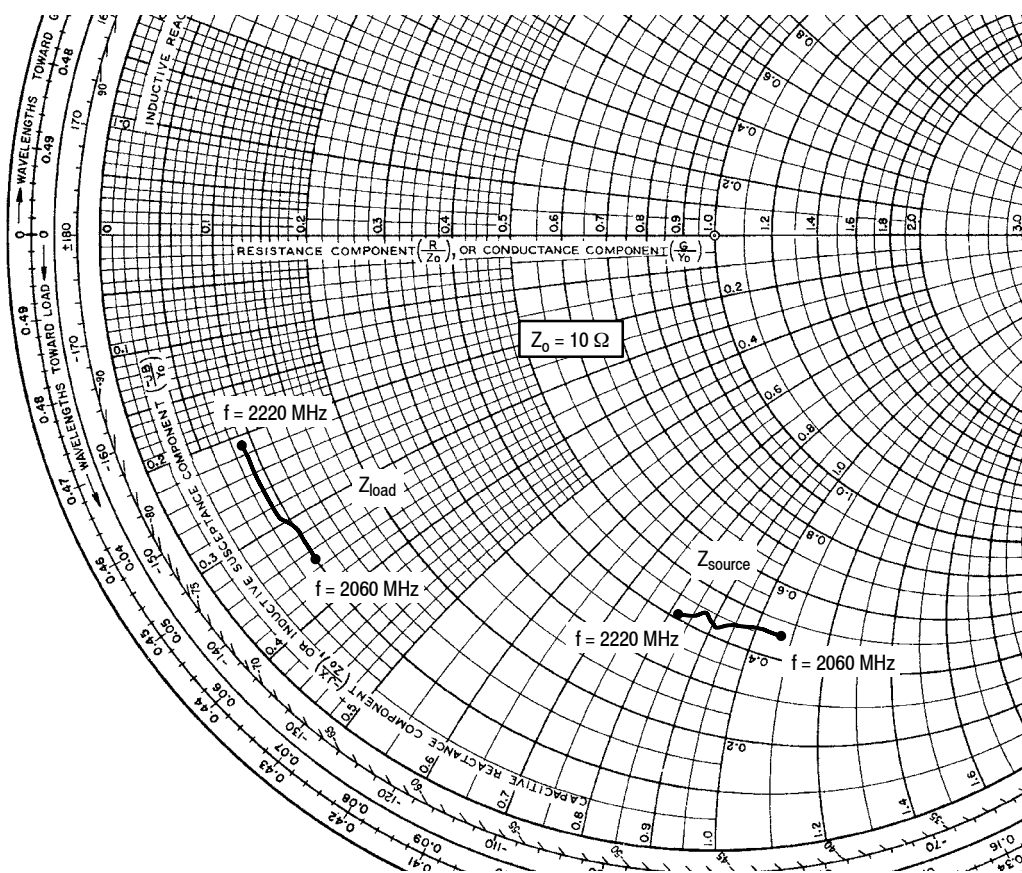

Figure 14. Single-Carrier W-CDMA Spectrum



$V_{DD} = 28 \text{ Vdc}$, $I_{DQ} = 1400 \text{ mA}$, $P_{out} = 50 \text{ W Avg.}$

f MHz	Z_{source} Ω	Z_{load} Ω
2060	4.57 - j10.70	1.02 - j3.54
2080	4.57 - j10.38	0.99 - j3.34
2100	4.57 - j10.06	0.96 - j3.14
2120	4.52 - j9.72	0.93 - j2.94
2140	4.40 - j9.42	0.92 - j2.76
2160	4.15 - j9.12	0.91 - j2.59
2180	4.44 - j8.82	0.89 - j2.42
2200	4.19 - j8.53	0.88 - j2.25
2220	4.12 - j8.23	0.88 - j2.09

Z_{source} = Test circuit impedance as measured from gate to ground.

Z_{load} = Test circuit impedance as measured from drain to ground.

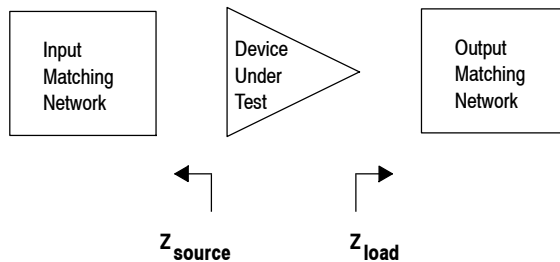
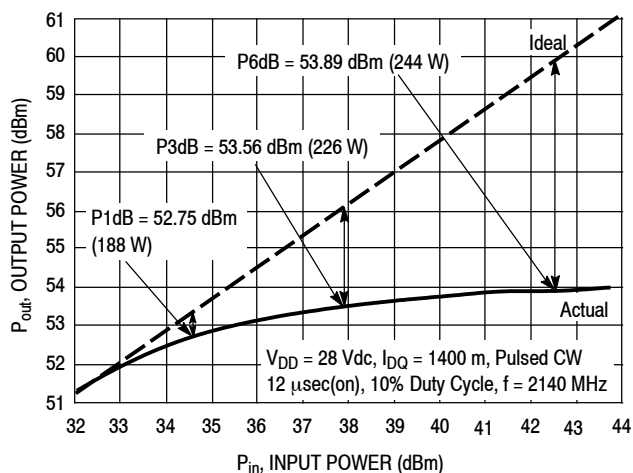

Figure 15. Series Equivalent Source and Load Impedance

ALTERNATIVE PEAK TUNE LOAD PULL CHARACTERISTICS



NOTE: Measured in a Peak Tuned Load Pull Fixture

Test Impedances per Compression Level

	Z_{source} Ω	Z_{load} Ω
P3dB	4.43 - j11.85	0.81 - j2.87

Figure 16. Pulsed CW Output Power versus Input Power @ 28 V

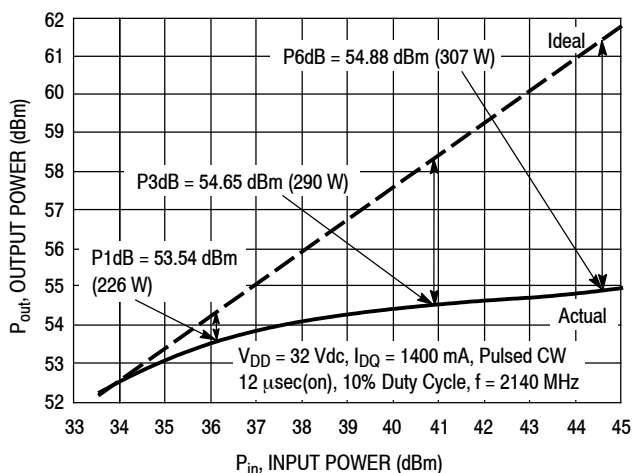

NOTE: Measured in a Peak Tuned Load Pull Fixture

Test Impedances per Compression Level

	Z_{source} Ω	Z_{load} Ω
P3dB	4.43 - j11.85	0.72 - j2.87

Figure 17. Pulsed CW Output Power versus Input Power @ 32 V

PACKAGE DIMENSIONS

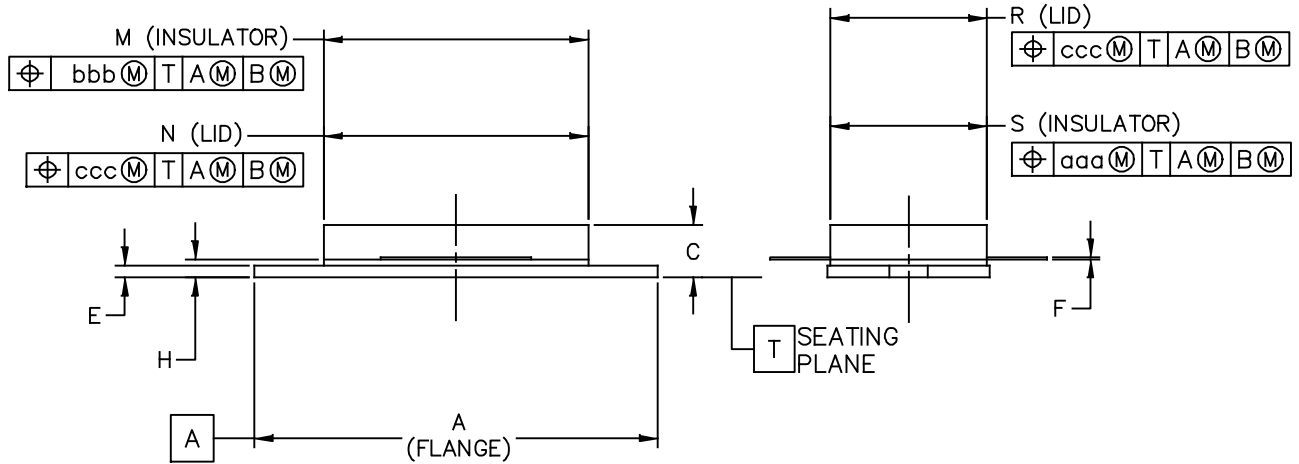
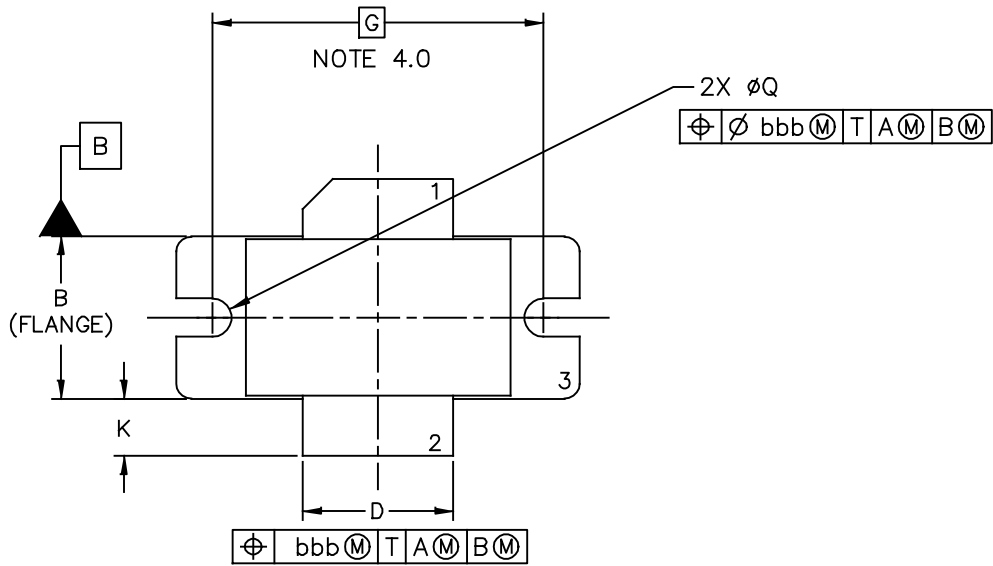

© FREESCALE SEMICONDUCTOR, INC. ALL RIGHTS RESERVED.	MECHANICAL OUTLINE	PRINT VERSION NOT TO SCALE	
TITLE: NI-880	DOCUMENT NO: 98ARB18493C	REV: F	
	CASE NUMBER: 465B-04	26 MAY 2011	
	STANDARD: NON-JEDEC		

NOTES:

- 1.0 DIMENSIONING AND TOLERANCING PER ANSI Y14.5M-1994.
- 2.0 CONTROLLING DIMENSION: INCH.
- 3.0 DIMENSION H IS MEASURED .030 (0.762) AWAY FROM PACKAGE BODY.
- 4.0 RECOMMENDED BOLT CENTER DIMENSION OF 1.16 (29.57) BASED ON M3 SCREW.

DIM	INCH		MILLIMETER		DIM	INCH		MILLIMETER	
	MIN	MAX	MIN	MAX		MIN	MAX	MIN	MAX
A	1.335	1.345	33.91	34.16	R	.515	-.525	13.08	- 13.34
B	.535	.545	13.59	13.84	S	.515	-.525	13.08	- 13.34
C	.147	.200	3.73	5.08	aaa	-	.007	-	0.178
D	.495	.505	12.57	12.83	bbb	-	.010	-	0.254
E	.035	.045	0.89	1.14	ccc	-	.015	-	0.381
F	.003	.006	0.08	0.15	-	-	-	-	-
G	1.100 BSC		27.94 BSC		-	-	-	-	-
H	.057	.067	1.45	1.70	-	-	-	-	-
K	.175	.205	4.45	5.21	-	-	-	-	-
M	.872	.888	22.15	22.56	-	-	-	-	-
N	.871	.889	22.12	22.58	-	-	-	-	-
Q	∅.118	∅.138	∅3.00	∅3.51	-	-	-	-	-
© FREESCALE SEMICONDUCTOR, INC. ALL RIGHTS RESERVED.			MECHANICAL OUTLINE			PRINT VERSION NOT TO SCALE			
TITLE: NI-880					DOCUMENT NO: 98ARB18493C			REV: F	
					CASE NUMBER: 465B-04			26 MAY 11	
					STANDARD: NON-JEDEC				

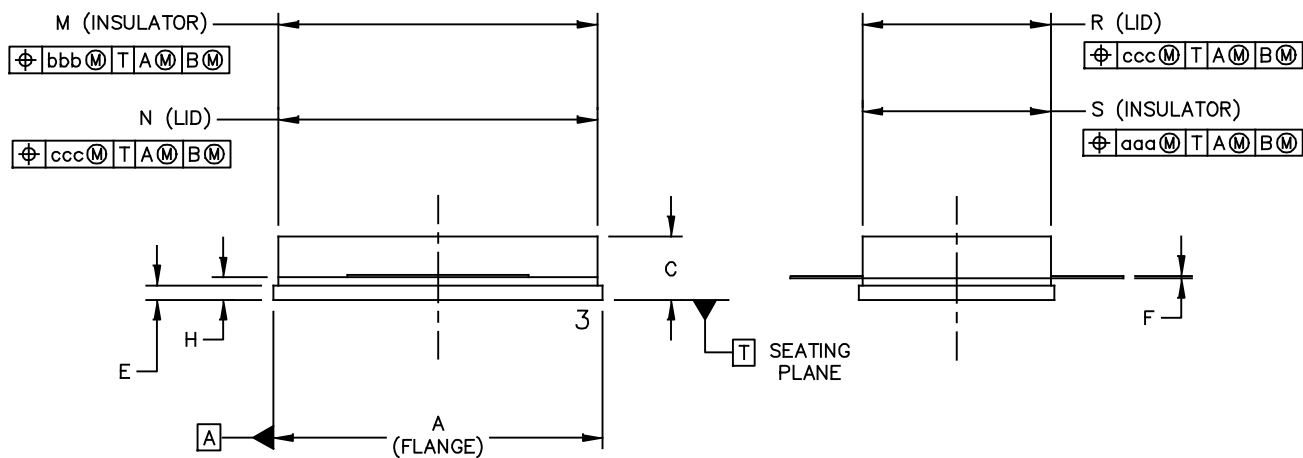
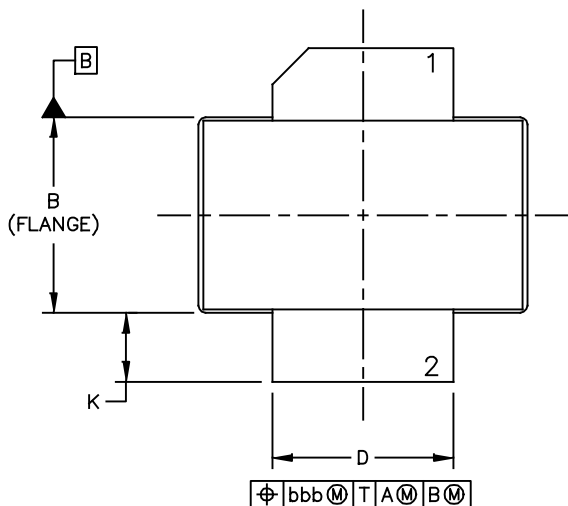

© FREESCALE SEMICONDUCTOR, INC. ALL RIGHTS RESERVED.		MECHANICAL OUTLINE	PRINT VERSION NOT TO SCALE
TITLE: NI-880S		DOCUMENT NO: 98ARB18660C	REV: E
		CASE NUMBER: 465C-03	26 MAY 2011
		STANDARD: NON-JEDEC	

NOTES:

1. DIMENSIONING AND TOLERANCING PER ANSI Y14.5M–1994.
2. CONTROLLING DIMENSION: INCH.
3. DIMENSION H IS MEASURED .030 (0.762) AWAY FROM PACKAGE BODY.

DIM	INCH		MILLIMETER		DIM	INCH		MILLIMETER		
	MIN	MAX	MIN	MAX		MIN	MAX	MIN	MAX	
A	.905	– .915	22.99	– 23.24	aaa	– .007	–	–	0.178	–
B	.535	– .545	13.59	– 13.84	bbb	– .010	–	–	0.254	–
C	.147	– .200	3.73	– 5.08	ccc	– .015	–	–	0.381	–
D	.495	– .505	12.57	– 12.83	–	–	–	–	–	–
E	.035	– .045	0.89	– 1.14	–	–	–	–	–	–
F	.003	– .006	0.08	– 0.15	–	–	–	–	–	–
H	.057	– .067	1.45	– 1.70	–	–	–	–	–	–
K	.170	– .210	4.32	– 5.33	–	–	–	–	–	–
M	.872	– .888	22.15	– 22.56	–	–	–	–	–	–
N	.871	– .889	22.12	– 22.58	–	–	–	–	–	–
R	.515	– .525	13.08	– 13.34	–	–	–	–	–	–
S	.515	– .525	13.08	– 13.34	–	–	–	–	–	–

© FREESCALE SEMICONDUCTOR, INC. ALL RIGHTS RESERVED.		MECHANICAL OUTLINE		PRINT VERSION NOT TO SCALE	
TITLE: NI–880S		DOCUMENT NO: 98ARB18660C		REV: E	
		CASE NUMBER: 465C–03		26 MAY 2011	
		STANDARD: NON–JEDEC			

PRODUCT DOCUMENTATION AND SOFTWARE

Refer to the following documents and software to aid your design process.

Application Notes

- AN1955: Thermal Measurement Methodology of RF Power Amplifiers

Engineering Bulletins

- EB212: Using Data Sheet Impedances for RF LDMOS Devices

Software

- Electromigration MTTF Calculator
- RF High Power Model

For Software, do a Part Number search at <http://www.freescale.com>, and select the “Part Number” link. Go to the Software & Tools tab on the part’s Product Summary page to download the respective tool.

REVISION HISTORY

The following table summarizes revisions to this document.

Revision	Date	Description
0	May 2006	<ul style="list-style-type: none"> • Initial Release of Data Sheet
1	June 2006	<ul style="list-style-type: none"> • Added Class C to description of parts, pg. 1 • Changeded “≥” to “-” in the Device Output Signal Par bullet, pg. 1 • Changed typ value from ±9 to 18 in Part-to-Part Phase Variation characteristic description in Table 4, Typical Performances, p. 2 • Expanded the characterization range in the MTTF Factor graph from 200°C to 230°C, Fig. 12, p. 7
2	Aug. 2006	<ul style="list-style-type: none"> • Added Greater Negative Source bullet to Features section, p. 1 • Corrected Fig. 14, Single-Carrier W-CDMA Spectrum, to 3.84 MHz, p. 7
3	Sept. 2006	<ul style="list-style-type: none"> • Changed “Capable of Handling” bullet from 10:1 VSWR @ 28 Vdc to 5:1 VSWR @ 32 Vdc, pg. 1 • Added “Insertion” to Part-to-Part Phase Variation characteristic description in Table 4, Typical Performances, p. 2 • Added Gain Flatness, Group Delay and Deviation from Linear Phase characteristics to Table 4, Typical Performances, p. 2 • Corrected Z6 value from “0.119” to “0.156”, corrected Z8 value from “0.156” to “0.119”, corrected Z9 value from “0.770” to “0.077”, corrected Z11 value from “0.076” to “0.760”, Fig. 1, Test Circuit Schematic, p. 3 • Added Part Number and Manufacturer for R1, R2 and R3 in Table 5, Test Circuit Component Designations and Values, p. 3 • Added Figure 10, Digital Predistortion Correction, p. 6 • Corrected Fig. 15, Single-Carrier W-CDMA Spectrum, to correctly reflect integrated bandwidth offsets, p. 7 • Added Figure 17, Pulsed CW Output Power versus Input Power @ 28 Vdc, p. 9 • Added Figure 18, Pulsed CW Output Power versus Input Power @ 32 Vdc, p. 9
4	May 2007	<ul style="list-style-type: none"> • Removed “Designed for Digital Predistortion Error Correction Systems” bullet as functionality is standard, p. 1 • Added “Optimized for Doherty Applications” bullet to Features section, p. 1 • Operating Junction Temperature increased from 200°C to 225°C in Maximum Ratings table and related “Continuous use at maximum temperature will affect MTTF” footnote added, p. 1 • Removed footnote and “Measured in Functional Test” from the RF test condition voltage callout for $V_{GS(Q)}$, and added Fixture Gate Quiescent Voltage, $V_{GG(Q)}$ to On Characteristics table, p. 2 • Updated verbiage in Typical Performances table, p. 3 • Updated Part Numbers in Table 5, Component Designations and Values, to RoHS compliant part numbers and updated obsolete ATC600 series capacitors to ATC100 series, p. 4 • Adjusted scale for Fig. 8, Intermodulation Distortion Products versus Tone Spacing, to show wider dynamic range, p. 7 • Replaced Fig. 13, MTTF versus Junction Temperature with updated graph. Removed Amps² and listed operating characteristics and location of MTTF calculator for device, p. 8 • Fig. 14, CCDF W-CDMA 3GPP, Test Model 1, 64 DPCH, 50% Clipping, Single-Carrier Test Signal, updated to include output power level at functional test, p. 8

(continued)

MRF7S21170HR3 MRF7S21170HSR3

REVISION HISTORY (continued)

Revision	Date	Description
5	Apr. 2008	<ul style="list-style-type: none"> • Corrected On Characteristics table I_D value for $V_{GS(th)}$ from 270 μAdc to 372 μAdc and $V_{DS(on)}$ from 2.7 Adc to 3.72 Adc; tightened $V_{GS(th)}$ minimum and maximum values to match production test values, p. 2 • Updated Part Numbers in Table 5, Component Designations and Values, to latest RoHS compliant part numbers, p. 4 • Updated Fig. 14, CCDF W-CDMA 3GPP, Test Model 1, 64 DPCH, 50% Clipping, Single-Carrier Test Signal, to better represent production test signal, p. 8
6	Mar. 2011	<ul style="list-style-type: none"> • Modified data sheet to reflect RF Test Reduction described in Product and Process Change Notification number, PCN13628, p. 1, 2 • Fig. 13, MTTF versus Junction Temperature removed, p. 8. Refer to the device's MTTF Calculator available at freescale.com/RFpower. Go to Design Resources > Software and Tools. • Fig. 14, CCDF W-CDMA IQ Magnitude Clipping, Single-Carrier Test Signal and Fig. 15, Single-Carrier W-CDMA Spectrum updated to show the undistorted input test signal, p. 8 (renumbered as Figs. 13 and 14 respectively after Fig. 13 removed) • Added Electromigration MTTF Calculator and RF High Power Model availability to Product Software, p. 15
7	Feb. 2012	<ul style="list-style-type: none"> • Table 3, ESD Protection Characteristics, removed the word "Minimum" after the ESD class rating. ESD ratings are characterized during new product development but are not 100% tested during production. ESD ratings provided in the data sheet are intended to be used as a guideline when handling ESD sensitive devices, p. 2. • Replaced Case Outline 465B-03, Issue D, with 465B-04, Issue F, p. 1, 11-12. Deleted Style 1 pin note on Sheet 2. On Sheet 2, changed dimension B in mm from 13.6-13.8 to 13.59-13.84, changed dimension H in mm from 1.45-1.7 to 1.45-1.70, changed dimension K in mm from 4.44-5.21 to 4.45-5.21, changed dimension M in mm from 22.15-22.55 to 22.15-22.56, changed dimension N in mm from 19.3-22.6 to 22.12-22.58, changed dimension Q in mm from 3-3.51 to 3.00-3.51, changed dimension R and S in mm from 13.1-13.3 to 13.08-13.34. • Replaced Case Outline 465C-02, Issue D, with 465C-03, Issue E, p. 1, 13-14. Deleted Style 1 pin note on Sheet 2. On Sheet 2, changed dimension B in mm from 13.6-13.8 to 13.59-13.84, changed dimension H in mm from 1.45-1.7 to 1.45-1.70, changed dimension M in mm from 22.15-22.55 to 22.15-22.56, changed dimension N in mm from 19.3-22.6 to 22.12-22.58, changed dimension R and S in mm from 13.1-13.3 to 13.08-13.34.

How to Reach Us:

Home Page:

www.freescale.com

Web Support:

<http://www.freescale.com/support>

USA/Europe or Locations Not Listed:

Freescale Semiconductor, Inc.
Technical Information Center, EL516
2100 East Elliot Road
Tempe, Arizona 85284
1-800-521-6274 or +1-480-768-2130
www.freescale.com/support

Europe, Middle East, and Africa:

Freescale Halbleiter Deutschland GmbH
Technical Information Center
Schatzbogen 7
81829 Muenchen, Germany
+44 1296 380 456 (English)
+46 8 52200080 (English)
+49 89 92103 559 (German)
+33 1 69 35 48 48 (French)
www.freescale.com/support

Japan:

Freescale Semiconductor Japan Ltd.
Headquarters
ARCO Tower 15F
1-8-1, Shimo-Meguro, Meguro-ku,
Tokyo 153-0064
Japan
0120 191014 or +81 3 5437 9125
support.japan@freescale.com

Asia/Pacific:

Freescale Semiconductor China Ltd.
Exchange Building 23F
No. 118 Jianguo Road
Chaoyang District
Beijing 100022
China
+86 10 5879 8000
support.asia@freescale.com

For Literature Requests Only:

Freescale Semiconductor Literature Distribution Center
1-800-441-2447 or +1-303-675-2140
Fax: +1-303-675-2150
LDCForFreescaleSemiconductor@hibbertgroup.com

Information in this document is provided solely to enable system and software implementers to use Freescale Semiconductor products. There are no express or implied copyright licenses granted hereunder to design or fabricate any integrated circuits or integrated circuits based on the information in this document.

Freescale Semiconductor reserves the right to make changes without further notice to any products herein. Freescale Semiconductor makes no warranty, representation or guarantee regarding the suitability of its products for any particular purpose, nor does Freescale Semiconductor assume any liability arising out of the application or use of any product or circuit, and specifically disclaims any and all liability, including without limitation consequential or incidental damages. "Typical" parameters that may be provided in Freescale Semiconductor data sheets and/or specifications can and do vary in different applications and actual performance may vary over time. All operating parameters, including "Typicals", must be validated for each customer application by customer's technical experts. Freescale Semiconductor does not convey any license under its patent rights nor the rights of others. Freescale Semiconductor products are not designed, intended, or authorized for use as components in systems intended for surgical implant into the body, or other applications intended to support or sustain life, or for any other application in which the failure of the Freescale Semiconductor product could create a situation where personal injury or death may occur. Should Buyer purchase or use Freescale Semiconductor products for any such unintended or unauthorized application, Buyer shall indemnify and hold Freescale Semiconductor and its officers, employees, subsidiaries, affiliates, and distributors harmless against all claims, costs, damages, and expenses, and reasonable attorney fees arising out of, directly or indirectly, any claim of personal injury or death associated with such unintended or unauthorized use, even if such claim alleges that Freescale Semiconductor was negligent regarding the design or manufacture of the part.

Freescale™ and the Freescale logo are trademarks of Freescale Semiconductor, Inc. All other product or service names are the property of their respective owners.

© Freescale Semiconductor, Inc. 2006-2008, 2011-2012. All rights reserved.

Looking for pricing, stock, or lifecycle information?

Click below to explore more details on WIN SOURCE:

- ⊖ [View MRF7S21170HR3 on WIN SOURCE](#)
- ⊖ [Freescale Semiconductor - NXP Information](#)

Optimize Your Supply Chain with WIN SOURCE Solutions

- ✓ Global Sourcing Solution
- ✓ Obsolete Management
- ✓ Cost Control Management
- ✓ Shortage Management
- ✓ Alternative Solution
- ✓ Excess Inventory Management