



**THE DATASHEET OF  
MRF9060LSR1**



# RF Power Field Effect Transistors

## N-Channel Enhancement-Mode Lateral MOSFETs

Designed for broadband commercial and industrial applications with frequencies up to 1000 MHz. The high gain and broadband performance of these devices make them ideal for large-signal, common-source amplifier applications in 26 volt base station equipment.

- Typical Two-Tone Performance at 945 MHz, 26 Volts
  - Output Power — 60 Watts PEP
  - Power Gain — 17 dB
  - Efficiency — 40%
  - IMD — -31 dBc
- Capable of Handling 10:1 VSWR, @ 26 Vdc, 945 MHz, 60 Watts CW Output Power

### Features

- Integrated ESD Protection
- Designed for Maximum Gain and Insertion Phase Flatness
- Excellent Thermal Stability
- Characterized with Series Equivalent Large-Signal Impedance Parameters
- Low Gold Plating Thickness on Leads. L Suffix Indicates 40μ" Nominal.
- RoHS Compliant
- In Tape and Reel. R1 Suffix = 500 Units per 32 mm, 13 inch Reel.

**MRF9060LR1**  
**MRF9060LSR1**

**945 MHz, 60 W, 26 V**  
**LATERAL N-CHANNEL**  
**BROADBAND**  
**RF POWER MOSFETs**

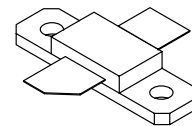

**CASE 360B-05, STYLE 1**  
**NI-360**  
**MRF9060LR1**

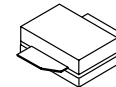

**CASE 360C-05, STYLE 1**  
**NI-360S**  
**MRF9060LSR1**

**Table 1. Maximum Ratings**

Rating	Symbol	Value	Unit
Drain-Source Voltage	$V_{DSS}$	- 0.5, +65	Vdc
Gate-Source Voltage	$V_{GS}$	- 0.5, +15	Vdc
Total Device Dissipation @ $T_C = 25^\circ\text{C}$ Derate above $25^\circ\text{C}$	MRF9060LR1 $P_D$	159 0.91	W W/ $^\circ\text{C}$
	MRF9060LSR1	219 1.25	W W/ $^\circ\text{C}$
Storage Temperature Range	$T_{stg}$	- 65 to +150	$^\circ\text{C}$
Case Operating Temperature	$T_C$	150	$^\circ\text{C}$
Operating Junction Temperature	$T_J$	200	$^\circ\text{C}$

**Table 2. Thermal Characteristics**

Characteristic	Symbol	Value (1)	Unit
Thermal Resistance, Junction to Case	MRF9060LR1 $R_{\theta JC}$ MRF9060LSR1	1.1 0.8	$^\circ\text{C}/\text{W}$

**Table 3. ESD Protection Characteristics**

Test Conditions	Class
Human Body Model	1 (Minimum)
Machine Model	M1 (Minimum)

1. MTTF calculator available at <http://www.freescale.com/rf>. Select Tools/Software/Application Software/Calculators to access the MTTF calculators by product.

**Table 4. Electrical Characteristics** ( $T_C = 25^\circ\text{C}$  unless otherwise noted)

Characteristic	Symbol	Min	Typ	Max	Unit
<b>Off Characteristics</b>					
Zero Gate Voltage Drain Leakage Current ( $V_{DS} = 65\text{ Vdc}$ , $V_{GS} = 0\text{ Vdc}$ )	$I_{DSS}$	—	—	10	$\mu\text{Adc}$
Zero Gate Voltage Drain Leakage Current ( $V_{DS} = 26\text{ Vdc}$ , $V_{GS} = 0\text{ Vdc}$ )	$I_{DSS}$	—	—	1	$\mu\text{Adc}$
Gate-Source Leakage Current ( $V_{GS} = 5\text{ Vdc}$ , $V_{DS} = 0\text{ Vdc}$ )	$I_{GSS}$	—	—	1	$\mu\text{Adc}$
<b>On Characteristics</b>					
Gate Threshold Voltage ( $V_{DS} = 10\text{ Vdc}$ , $I_D = 200\ \mu\text{Adc}$ )	$V_{GS(th)}$	2	2.9	4	Vdc
Gate Quiescent Voltage ( $V_{DS} = 26\text{ Vdc}$ , $I_D = 450\text{ mAdc}$ )	$V_{GS(Q)}$	—	3.7	—	Vdc
Drain-Source On-Voltage ( $V_{GS} = 10\text{ Vdc}$ , $I_D = 1.3\text{ Adc}$ )	$V_{DS(on)}$	—	0.17	0.4	Vdc
Forward Transconductance ( $V_{DS} = 10\text{ Vdc}$ , $I_D = 4\text{ Adc}$ )	$g_{fs}$	—	5.3	—	S
<b>Dynamic Characteristics</b>					
Input Capacitance ( $V_{DS} = 26\text{ Vdc} \pm 30\text{ mV(rms)ac}$ @ 1 MHz, $V_{GS} = 0\text{ Vdc}$ )	$C_{iss}$	—	98	—	pF
Output Capacitance ( $V_{DS} = 26\text{ Vdc} \pm 30\text{ mV(rms)ac}$ @ 1 MHz, $V_{GS} = 0\text{ Vdc}$ )	$C_{oss}$	—	50	—	pF
Reverse Transfer Capacitance ( $V_{DS} = 26\text{ Vdc} \pm 30\text{ mV(rms)ac}$ @ 1 MHz, $V_{GS} = 0\text{ Vdc}$ )	$C_{rss}$	—	2	—	pF

(continued)

ARCHIVE INFORMATION

ARCHIVE INFORMATION

**Table 4. Electrical Characteristics** ( $T_C = 25^\circ\text{C}$  unless otherwise noted) (continued)

Characteristic	Symbol	Min	Typ	Max	Unit
<b>Functional Tests</b> (In Freescale Test Fixture, 50 ohm system)					
Two-Tone Common-Source Amplifier Power Gain ( $V_{DD} = 26\text{ Vdc}$ , $P_{out} = 60\text{ W PEP}$ , $I_{DQ} = 450\text{ mA}$ , $f_1 = 945.0\text{ MHz}$ , $f_2 = 945.1\text{ MHz}$ )	$G_{ps}$	16	17	—	dB
Two-Tone Drain Efficiency ( $V_{DD} = 26\text{ Vdc}$ , $P_{out} = 60\text{ W PEP}$ , $I_{DQ} = 450\text{ mA}$ , $f_1 = 945.0\text{ MHz}$ , $f_2 = 945.1\text{ MHz}$ )	$\eta$	36	40	—	%
3rd Order Intermodulation Distortion ( $V_{DD} = 26\text{ Vdc}$ , $P_{out} = 60\text{ W PEP}$ , $I_{DQ} = 450\text{ mA}$ , $f_1 = 945.0\text{ MHz}$ , $f_2 = 945.1\text{ MHz}$ )	IMD	—	-31	-28	dBc
Input Return Loss ( $V_{DD} = 26\text{ Vdc}$ , $P_{out} = 60\text{ W PEP}$ , $I_{DQ} = 450\text{ mA}$ , $f_1 = 945.0\text{ MHz}$ , $f_2 = 945.1\text{ MHz}$ )	IRL	—	-16	-9	dB
Two-Tone Common-Source Amplifier Power Gain ( $V_{DD} = 26\text{ Vdc}$ , $P_{out} = 60\text{ W PEP}$ , $I_{DQ} = 450\text{ mA}$ , $f_1 = 930.0\text{ MHz}$ , $f_2 = 930.1\text{ MHz}$ and $f_1 = 960.0\text{ MHz}$ , $f_2 = 960.1\text{ MHz}$ )	$G_{ps}$	—	17	—	dB
Two-Tone Drain Efficiency ( $V_{DD} = 26\text{ Vdc}$ , $P_{out} = 60\text{ W PEP}$ , $I_{DQ} = 450\text{ mA}$ , $f_1 = 930.0\text{ MHz}$ , $f_2 = 930.1\text{ MHz}$ and $f_1 = 960.0\text{ MHz}$ , $f_2 = 960.1\text{ MHz}$ )	$\eta$	—	39	—	%
3rd Order Intermodulation Distortion ( $V_{DD} = 26\text{ Vdc}$ , $P_{out} = 60\text{ W PEP}$ , $I_{DQ} = 450\text{ mA}$ , $f_1 = 930.0\text{ MHz}$ , $f_2 = 930.1\text{ MHz}$ and $f_1 = 960.0\text{ MHz}$ , $f_2 = 960.1\text{ MHz}$ )	IMD	—	-31	—	dBc
Input Return Loss ( $V_{DD} = 26\text{ Vdc}$ , $P_{out} = 60\text{ W PEP}$ , $I_{DQ} = 450\text{ mA}$ , $f_1 = 930.0\text{ MHz}$ , $f_2 = 930.1\text{ MHz}$ and $f_1 = 960.0\text{ MHz}$ , $f_2 = 960.1\text{ MHz}$ )	IRL	—	-16	—	dB
Power Output, 1 dB Compression Point ( $V_{DD} = 26\text{ Vdc}$ , $P_{out} = 60\text{ W CW}$ , $I_{DQ} = 450\text{ mA}$ , $f_1 = 945.0\text{ MHz}$ )	$P_{1dB}$	—	70	—	W
Common-Source Amplifier Power Gain ( $V_{DD} = 26\text{ Vdc}$ , $P_{out} = 60\text{ W CW}$ , $I_{DQ} = 450\text{ mA}$ , $f_1 = 945.0\text{ MHz}$ )	$G_{ps}$	—	17	—	dB
Drain Efficiency ( $V_{DD} = 26\text{ Vdc}$ , $P_{out} = 60\text{ W CW}$ , $I_{DQ} = 450\text{ mA}$ , $f_1 = 945.0\text{ MHz}$ )	$\eta$	—	51	—	%

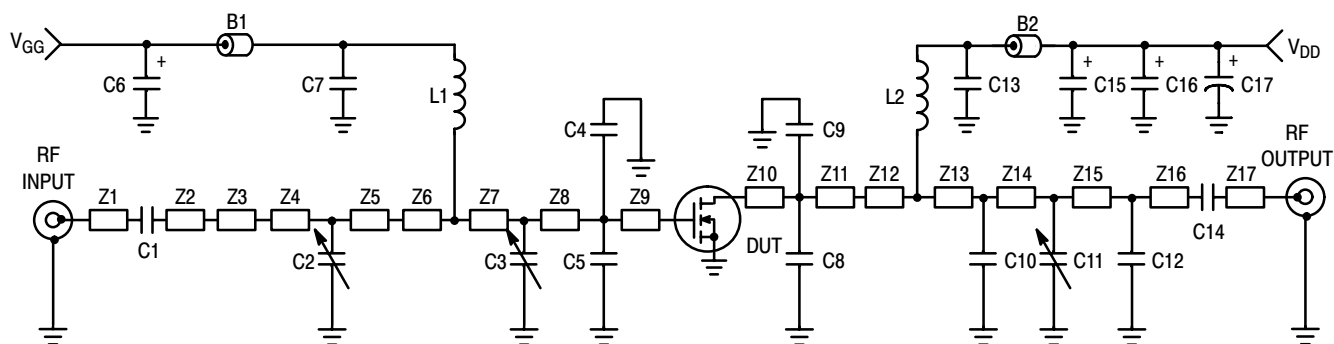

Z1	0.240" x 0.060" Microstrip	Z10	0.360" x 0.270" Microstrip
Z2	0.240" x 0.060" Microstrip	Z11	0.060" x 0.270" Microstrip
Z3	0.500" x 0.100" Microstrip	Z12	0.110" x 0.060" Microstrip
Z4	0.180" x 0.270" Microstrip	Z13	0.330" x 0.060" Microstrip
Z5	0.350" x 0.270" Microstrip	Z14	0.230" x 0.060" Microstrip
Z6	0.270" x 0.520 x 0.140" Taper	Z15	0.740" x 0.060" Microstrip
Z7	0.170" x 0.520" Microstrip	Z16	0.130" x 0.060" Microstrip
Z8	0.410" x 0.520" Microstrip	Z17	0.340" x 0.060" Microstrip
Z9	0.060" x 0.520" Microstrip	PCB	Taconic RF -35 -0300, 30 mil, $\epsilon_r = 3.55$

**Figure 1. 945 MHz Broadband Test Circuit Schematic**

**Table 5. 945 MHz Broadband Test Circuit Component Designations and Values**

Part	Description	Part Number	Manufacturer
B1	Short Ferrite Bead	95F786	Newark
B2	Long Ferrite Bead	95F787	Newark
C1, C7, C13, C14	47 pF Chip Capacitors	100B470JP 500X	ATC
C2, C3, C11	0.8 - 8.0 Gigatrim Variable Capacitors	44F3360	Newark
C4, C5, C8, C9	10 pF Chip Capacitors	100B100JP 500X	ATC
C6, C15, C16	10 $\mu$ F, 35 V Tantalum Chip Capacitor	93F2975	Newark
C10	3.0 pF Chip Capacitor	100B3R0JP 500X	ATC
C12	0.5 pF Chip Capacitor (MRF9060) 0.7 pF Chip Capacitor (MRF9060S)	100B0R5BP 500X 100B0R7BP 500X	ATC ATC
C17	220 $\mu$ F Electrolytic Chip Capacitor	14F185	Newark
L1, L2	12.5 nH Inductors	A04T-5	Coilcraft
N1, N2	N-Type Panel Mount, Stripline	3052-1648-10	Avnet
WB1, WB2	10 mil Brass Wear Blocks		

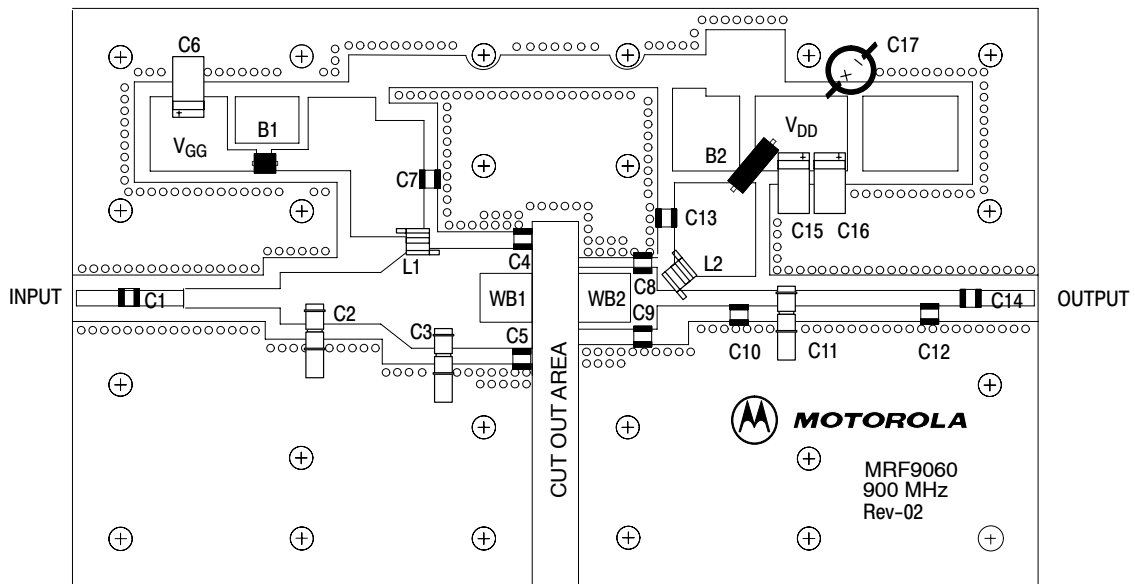

Freescale has begun the transition of marking Printed Circuit Boards (PCBs) with the Freescale Semiconductor signature/logo. PCBs may have either Motorola or Freescale markings during the transition period. These changes will have no impact on form, fit or function of the current product.

**Figure 2. 930 - 960 MHz Broadband Test Circuit Component Layout**

### TYPICAL CHARACTERISTICS

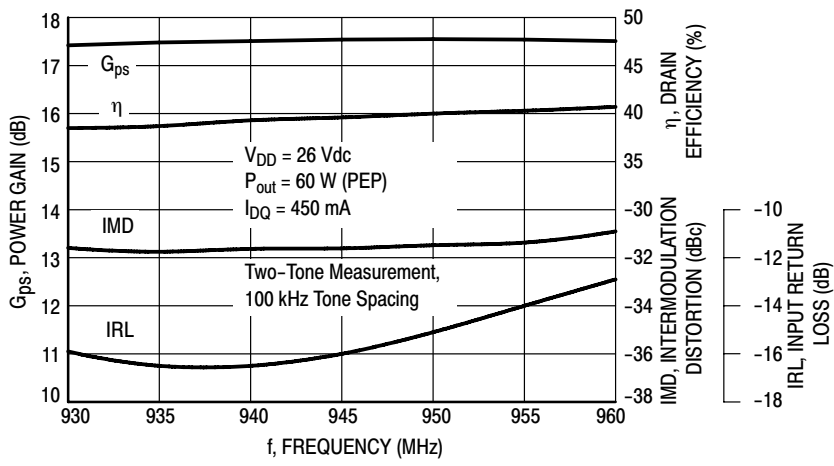

Figure 3. Class AB Broadband Circuit Performance

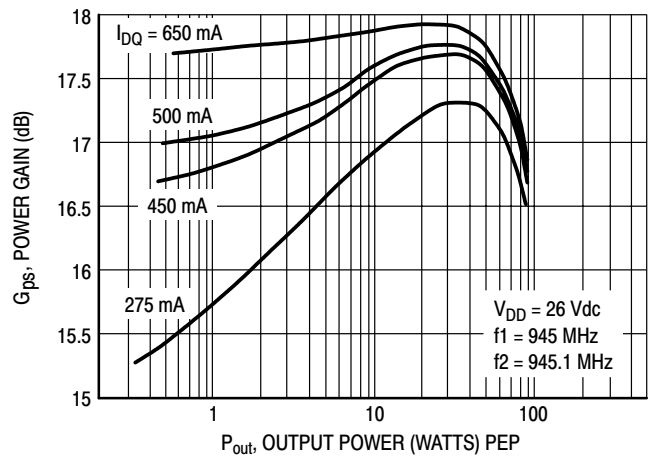

Figure 4. Power Gain versus Output Power

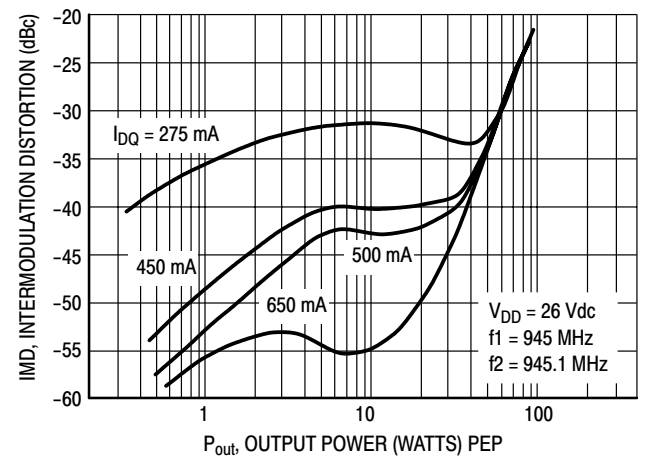

Figure 5. Intermodulation Distortion versus Output Power

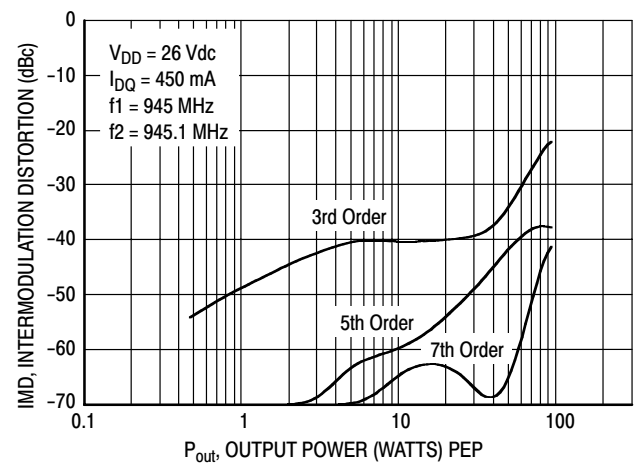

Figure 6. Intermodulation Distortion Products versus Output Power

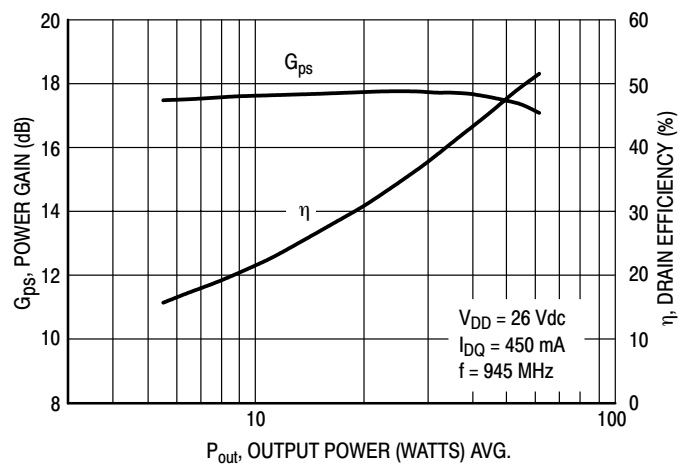
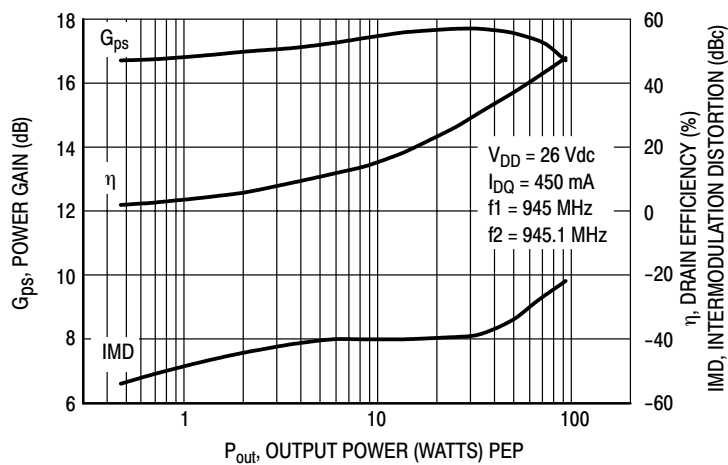

Figure 7. Power Gain and Efficiency versus Output Power

ARCHIVE INFORMATION

ARCHIVE INFORMATION

### TYPICAL CHARACTERISTICS



**Figure 8. Power Gain, Efficiency, and IMD versus Output Power**

ARCHIVE INFORMATION

ARCHIVE INFORMATION

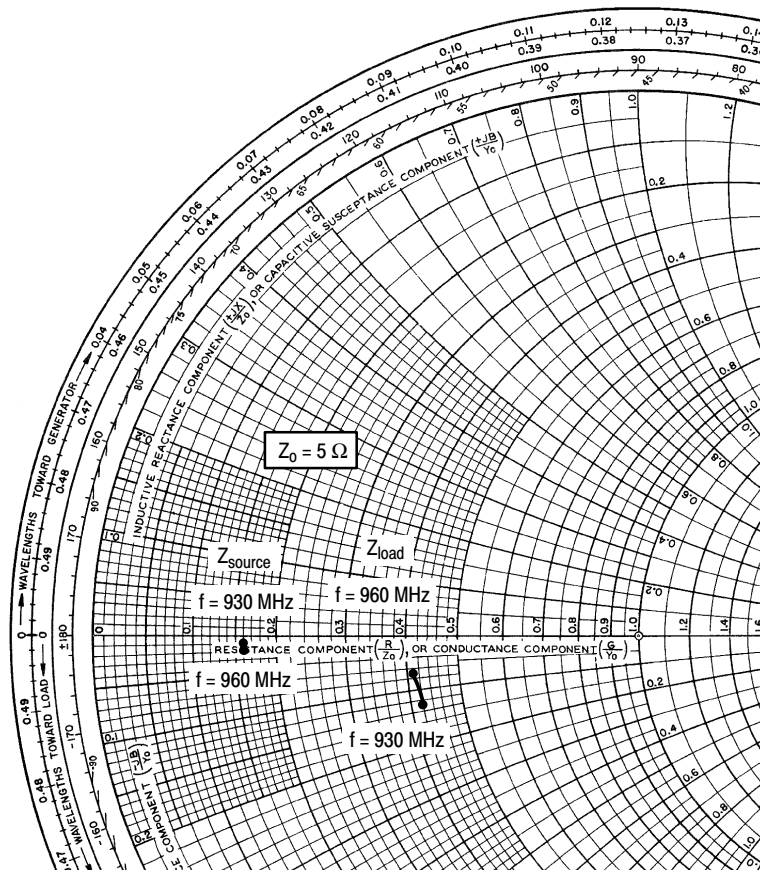

$V_{DD} = 26\text{ V}$ ,  $I_{DQ} = 450\text{ mA}$ ,  $P_{out} = 60\text{ W PEP}$

f MHz	$Z_{source}$ $\Omega$	$Z_{load}$ $\Omega$
930	$0.80 - j0.10$	$2.08 - j0.65$
945	$0.80 - j0.05$	$2.07 - j0.38$
960	$0.81 - j0.10$	$2.04 - j0.37$

$Z_{source}$  = Test circuit impedance as measured from gate to ground.

$Z_{load}$  = Test circuit impedance as measured from drain to ground.

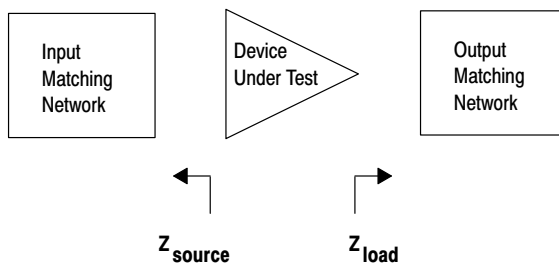

Figure 9. Series Equivalent Source and Load Impedance

ARCHIVE INFORMATION

ARCHIVE INFORMATION

ARCHIVE INFORMATION

ARCHIVE INFORMATION

### PACKAGE DIMENSIONS

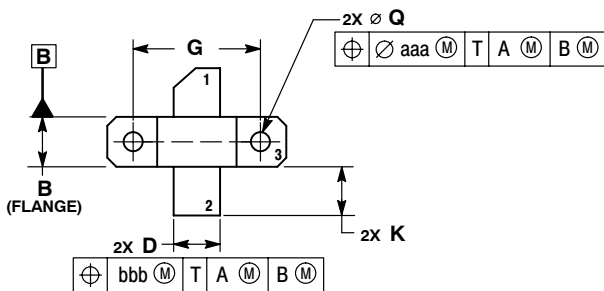

- NOTES:
1. INTERPRET DIMENSIONS AND TOLERANCES PER ASME Y14.5M-1994.
  2. CONTROLLING DIMENSION: INCH.
  3. DIMENSION H IS MEASURED 0.030 (0.762) AWAY FROM PACKAGE BODY.

DIM	INCHES		MILLIMETERS	
	MIN	MAX	MIN	MAX
A	0.795	0.805	20.19	20.45
B	0.225	0.235	5.72	5.97
C	0.125	0.175	3.18	4.45
D	0.210	0.220	5.33	5.59
E	0.055	0.065	1.40	1.65
F	0.004	0.006	0.10	0.15
G	0.562 BSC		14.28 BSC	
H	0.077	0.087	1.96	2.21
K	0.220	0.250	5.59	6.35
M	0.355	0.365	9.02	9.27
N	0.357	0.363	9.07	9.22
Q	0.125	0.135	3.18	3.43
R	0.227	0.233	5.77	5.92
S	0.225	0.235	5.72	5.97
aaa	0.005 REF		0.13 REF	
bbb	0.010 REF		0.25 REF	
ccc	0.015 REF		0.38 REF	

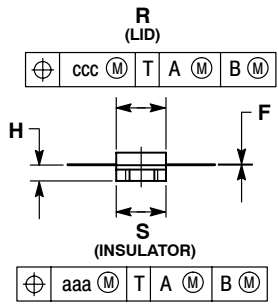
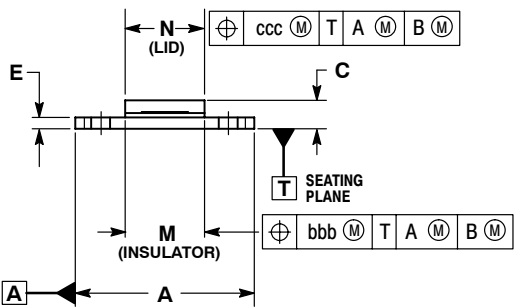

- STYLE 1:  
 PIN 1. DRAIN  
 2. GATE  
 3. SOURCE

**CASE 360B-05  
 ISSUE G  
 NI-360  
 MRF9060LR1**

ARCHIVE INFORMATION

ARCHIVE INFORMATION

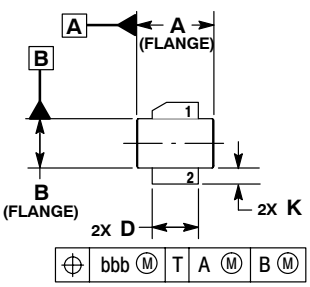

- NOTES:
1. INTERPRET DIMENSIONS AND TOLERANCES PER ASME Y14.5M-1994.
  2. CONTROLLING DIMENSION: INCH.
  3. DIMENSION H IS MEASURED 0.030 (0.762) AWAY FROM PACKAGE BODY.

DIM	INCHES		MILLIMETERS	
	MIN	MAX	MIN	MAX
A	0.375	0.385	9.53	9.78
B	0.225	0.235	5.72	5.97
C	0.105	0.155	2.67	3.94
D	0.210	0.220	5.33	5.59
E	0.035	0.045	0.89	1.14
F	0.004	0.006	0.10	0.15
H	0.057	0.067	1.45	1.70
K	0.085	0.115	2.16	2.92
M	0.355	0.365	9.02	9.27
N	0.357	0.363	9.07	9.22
R	0.227	0.23	5.77	5.92
S	0.225	0.235	5.72	5.97
aaa	0.005 REF		0.13 REF	
bbb	0.010 REF		0.25 REF	
ccc	0.015 REF		0.38 REF	

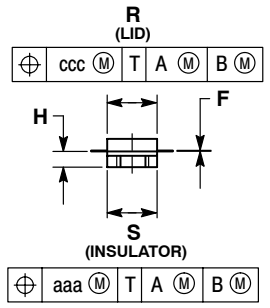
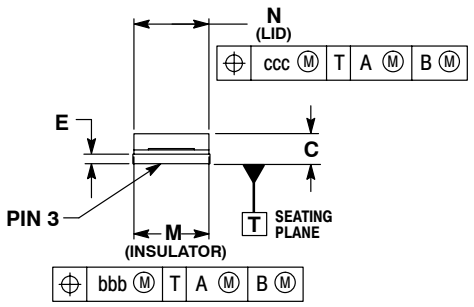

- STYLE 1:  
 PIN 1. DRAIN  
 2. GATE  
 3. SOURCE

**CASE 360C-05  
 ISSUE E  
 NI-360S  
 MRF9060LSR1**

**How to Reach Us:**

**Home Page:**  
www.freescale.com

**E-mail:**  
support@freescale.com

**USA/Europe or Locations Not Listed:**  
Freescale Semiconductor  
Technical Information Center, CH370  
1300 N. Alma School Road  
Chandler, Arizona 85224  
+1-800-521-6274 or +1-480-768-2130  
support@freescale.com

**Europe, Middle East, and Africa:**  
Freescale Halbleiter Deutschland GmbH  
Technical Information Center  
Schatzbogen 7  
81829 Muenchen, Germany  
+44 1296 380 456 (English)  
+46 8 52200080 (English)  
+49 89 92103 559 (German)  
+33 1 69 35 48 48 (French)  
support@freescale.com

**Japan:**  
Freescale Semiconductor Japan Ltd.  
Headquarters  
ARCO Tower 15F  
1-8-1, Shimo-Meguro, Meguro-ku,  
Tokyo 153-0064  
Japan  
0120 191014 or +81 3 5437 9125  
support.japan@freescale.com

**Asia/Pacific:**  
Freescale Semiconductor Hong Kong Ltd.  
Technical Information Center  
2 Dai King Street  
Tai Po Industrial Estate  
Tai Po, N.T., Hong Kong  
+800 2666 8080  
support.asia@freescale.com

**For Literature Requests Only:**  
Freescale Semiconductor Literature Distribution Center  
P.O. Box 5405  
Denver, Colorado 80217  
1-800-441-2447 or 303-675-2140  
Fax: 303-675-2150  
LDCForFreescaleSemiconductor@hibbertgroup.com

Information in this document is provided solely to enable system and software implementers to use Freescale Semiconductor products. There are no express or implied copyright licenses granted hereunder to design or fabricate any integrated circuits or integrated circuits based on the information in this document.

Freescale Semiconductor reserves the right to make changes without further notice to any products herein. Freescale Semiconductor makes no warranty, representation or guarantee regarding the suitability of its products for any particular purpose, nor does Freescale Semiconductor assume any liability arising out of the application or use of any product or circuit, and specifically disclaims any and all liability, including without limitation consequential or incidental damages. "Typical" parameters that may be provided in Freescale Semiconductor data sheets and/or specifications can and do vary in different applications and actual performance may vary over time. All operating parameters, including "Typicals", must be validated for each customer application by customer's technical experts. Freescale Semiconductor does not convey any license under its patent rights nor the rights of others. Freescale Semiconductor products are not designed, intended, or authorized for use as components in systems intended for surgical implant into the body, or other applications intended to support or sustain life, or for any other application in which the failure of the Freescale Semiconductor product could create a situation where personal injury or death may occur. Should Buyer purchase or use Freescale Semiconductor products for any such unintended or unauthorized application, Buyer shall indemnify and hold Freescale Semiconductor and its officers, employees, subsidiaries, affiliates, and distributors harmless against all claims, costs, damages, and expenses, and reasonable attorney fees arising out of, directly or indirectly, any claim of personal injury or death associated with such unintended or unauthorized use, even if such claim alleges that Freescale Semiconductor was negligent regarding the design or manufacture of the part.

Freescale™ and the Freescale logo are trademarks of Freescale Semiconductor, Inc. All other product or service names are the property of their respective owners.  
© Freescale Semiconductor, Inc. 2006, 2008. All rights reserved.

## Looking for pricing, stock, or lifecycle information?

Click below to explore more details on WIN SOURCE:

- ⊖ [View MRF9060LSR1 on WIN SOURCE](#)
- ⊖ [Freescale Semiconductor - NXP Information](#)

## Optimize Your Supply Chain with WIN SOURCE Solutions

- ✓ Global Sourcing Solution
- ✓ Obsolete Management
- ✓ Cost Control Management
- ✓ Shortage Management
- ✓ Alternative Solution
- ✓ Excess Inventory Management