



**THE DATASHEET OF
MRFE6S9060NR1**



RF Power Field Effect Transistor

N-Channel Enhancement-Mode Lateral MOSFET

Designed for broadband commercial and industrial applications with frequencies up to 1000 MHz. The high gain and broadband performance of this device makes it ideal for large-signal, common-source amplifier applications in 28 volt base station equipment.

- Typical Single-Carrier N-CDMA Performance @ 880 MHz, $V_{DD} = 28$ Volts, $I_{DQ} = 450$ mA, $P_{out} = 14$ Watts Avg., IS-95 CDMA (Pilot, Sync, Paging, Traffic Codes 8 Through 13) Channel Bandwidth = 1.2288 MHz. PAR = 9.8 dB @ 0.01% Probability on CCDF.
 Power Gain — 21.1 dB
 Drain Efficiency — 33%
 ACPR @ 750 kHz Offset — -45.7 dBc in 30 kHz Channel Bandwidth
- Capable of Handling 10:1 VSWR, @ 32 Vdc, 880 MHz, 3 dB Overdrive, Designed for Enhanced Ruggedness

GSM EDGE Application

- Typical GSM EDGE Performance: $V_{DD} = 28$ Volts, $I_{DQ} = 500$ mA, $P_{out} = 21$ Watts Avg., Full Frequency Band (920-960 MHz)
 Power Gain — 20 dB
 Drain Efficiency — 46%
 Spectral Regrowth @ 400 kHz Offset = -62 dBc
 Spectral Regrowth @ 600 kHz Offset = -78 dBc
 EVM — 1.5% rms

GSM Application

- Typical GSM Performance: $V_{DD} = 28$ Volts, $I_{DQ} = 500$ mA, $P_{out} = 60$ Watts, Full Frequency Band (920-960 MHz)
 Power Gain — 20 dB
 Drain Efficiency — 63%

Features

- Characterized with Series Equivalent Large-Signal Impedance Parameters
- Integrated ESD Protection
- 225°C Capable Plastic Package
- RoHS Compliant
- In Tape and Reel. R1 Suffix = 500 Units per 24 mm, 13 inch Reel.

Table 1. Maximum Ratings

Rating	Symbol	Value	Unit
Drain-Source Voltage	V_{DSS}	- 0.5, +66	Vdc
Gate-Source Voltage	V_{GS}	- 0.5, +12	Vdc
Maximum Operation Voltage	V_{DD}	32, +0	Vdc
Storage Temperature Range	T_{stg}	- 65 to +150	°C
Case Operating Temperature	T_C	150	°C
Operating Junction Temperature (1,2)	T_J	225	°C

Table 2. Thermal Characteristics

Characteristic	Symbol	Value (2,3)	Unit
Thermal Resistance, Junction to Case	$R_{\theta JC}$		°C/W
Case Temperature 80°C, 60 W CW		0.77	
Case Temperature 78°C, 14 W CW		0.88	

1. Continuous use at maximum temperature will affect MTTF.
2. MTTF calculator available at <http://www.freescale.com/rf>. Select Tools (Software & Tools)/Calculators to access MTTF calculators by product.
3. Refer to AN1955, *Thermal Measurement Methodology of RF Power Amplifiers*. Go to <http://www.freescale.com/rf>. Select Documentation/Application Notes - AN1955.

MRFE6S9060NR1

**880 MHz, 14 W AVG., 28 V
 SINGLE N-CDMA
 LATERAL N-CHANNEL
 BROADBAND
 RF POWER MOSFET**

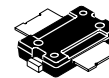

**CASE 1265-09, STYLE 1
 TO-270-2
 PLASTIC**

Table 3. ESD Protection Characteristics

Test Methodology	Class
Human Body Model (per JESD22-A114)	2 (Minimum)
Machine Model (per EIA/JESD22-A115)	B (Minimum)
Charge Device Model (per JESD22-C101)	III (Minimum)

Table 4. Moisture Sensitivity Level

Test Methodology	Rating	Package Peak Temperature	Unit
Per JESD 22-A113, IPC/JEDEC J-STD-020	3	260	°C

Table 5. Electrical Characteristics ($T_C = 25^\circ\text{C}$ unless otherwise noted)

Characteristic	Symbol	Min	Typ	Max	Unit
----------------	--------	-----	-----	-----	------

Off Characteristics

Zero Gate Voltage Drain Leakage Current ($V_{DS} = 66\text{ Vdc}$, $V_{GS} = 0\text{ Vdc}$)	I_{DSS}	—	—	10	μAdc
Zero Gate Voltage Drain Leakage Current ($V_{DS} = 28\text{ Vdc}$, $V_{GS} = 0\text{ Vdc}$)	I_{DSS}	—	—	1	μAdc
Gate-Source Leakage Current ($V_{GS} = 5\text{ Vdc}$, $V_{DS} = 0\text{ Vdc}$)	I_{GSS}	—	—	10	μAdc

On Characteristics

Gate Threshold Voltage ($V_{DS} = 10\text{ Vdc}$, $I_D = 200\ \mu\text{A}$)	$V_{GS(th)}$	1	2.2	3	Vdc
Gate Quiescent Voltage ($V_{DD} = 28\text{ Vdc}$, $I_D = 450\text{ mAdc}$, Measured in Functional Test)	$V_{GS(Q)}$	2	3	4	Vdc
Drain-Source On-Voltage ($V_{GS} = 10\text{ Vdc}$, $I_D = 1.5\text{ Adc}$)	$V_{DS(on)}$	0.05	0.27	0.4	Vdc

Dynamic Characteristics

Reverse Transfer Capacitance ($V_{DS} = 28\text{ Vdc} \pm 30\text{ mV(rms)ac}$ @ 1 MHz, $V_{GS} = 0\text{ Vdc}$)	C_{rss}	—	1.1	—	pF
Output Capacitance ($V_{DS} = 28\text{ Vdc} \pm 30\text{ mV(rms)ac}$ @ 1 MHz, $V_{GS} = 0\text{ Vdc}$)	C_{oss}	—	33	—	pF
Input Capacitance ($V_{DS} = 28\text{ Vdc}$, $V_{GS} = 0\text{ Vdc} \pm 30\text{ mV(rms)ac}$ @ 1 MHz)	C_{iss}	—	109	—	pF

Functional Tests (In Freescale Test Fixture, 50 ohm system) $V_{DD} = 28\text{ Vdc}$, $I_{DQ} = 450\text{ mA}$, $P_{out} = 14\text{ W Avg.}$, $f = 880\text{ MHz}$, Single-Carrier N-CDMA, 1.2288 MHz Channel Bandwidth Carrier. ACPR measured in 30 kHz Channel Bandwidth @ $\pm 750\text{ kHz}$ Offset. PAR = 9.8 dB @ 0.01% Probability on CCDF

Power Gain	G_{ps}	20	21.1	23	dB
Drain Efficiency	η_D	30.5	33	—	%
Adjacent Channel Power Ratio	ACPR	—	-45.7	-44	dBc
Input Return Loss	IRL	—	-18	-9	dB

(continued)

Table 5. Electrical Characteristics ($T_C = 25^\circ\text{C}$ unless otherwise noted) (continued)

Characteristic	Symbol	Min	Typ	Max	Unit
----------------	--------	-----	-----	-----	------

Typical GSM EDGE Performances (In Freescale GSM EDGE Test Fixture Optimized for 920-960 MHz, 50 ohm system) $V_{DD} = 28\text{ Vdc}$, $I_{DQ} = 500\text{ mA}$, $P_{out} = 21\text{ W Avg.}$, $f = 920\text{--}960\text{ MHz}$, GSM EDGE Signal

Power Gain	G_{ps}	—	20	—	dB
Drain Efficiency	η_D	—	46	—	%
Error Vector Magnitude	EVM	—	1.5	—	%
Spectral Regrowth at 400 kHz Offset	SR1	—	-62	—	dBc
Spectral Regrowth at 600 kHz Offset	SR2	—	-78	—	dBc

Typical CW Performances (In Freescale GSM Test Fixture Optimized for 920-960 MHz, 50 ohm system) $V_{DD} = 28\text{ Vdc}$, $I_{DQ} = 500\text{ mA}$, $P_{out} = 60\text{ W}$, $f = 920\text{--}960\text{ MHz}$

Power Gain	G_{ps}	—	20	—	dB
Drain Efficiency	η_D	—	63	—	%
Input Return Loss	IRL	—	-12	—	dB
P_{out} @ 1 dB Compression Point ($f = 940\text{ MHz}$)	P1dB	—	67	—	W

Typical Performances (In Freescale Test Fixture, 50 ohm system) $V_{DD} = 28\text{ Vdc}$, $I_{DQ} = 450\text{ mA}$, 865-900 MHz Bandwidth

Video Bandwidth @ 60 W PEP P_{out} where $IM3 = -30\text{ dBc}$ (Tone Spacing from 100 kHz to VBW) $\Delta IMD3 = IMD3$ @ VBW frequency - $IMD3$ @ 100 kHz $< 1\text{ dBc}$ (both sidebands)	VBW	—	3	—	MHz
Gain Flatness in 35 MHz Bandwidth @ $P_{out} = 14\text{ W Avg.}$	G_F	—	0.27	—	dB
Gain Variation over Temperature (-30°C to $+85^\circ\text{C}$)	ΔG	—	0.011	—	dB/ $^\circ\text{C}$
Output Power Variation over Temperature (-30°C to $+85^\circ\text{C}$)	$\Delta P1dB$	—	0.088	—	dBm/ $^\circ\text{C}$

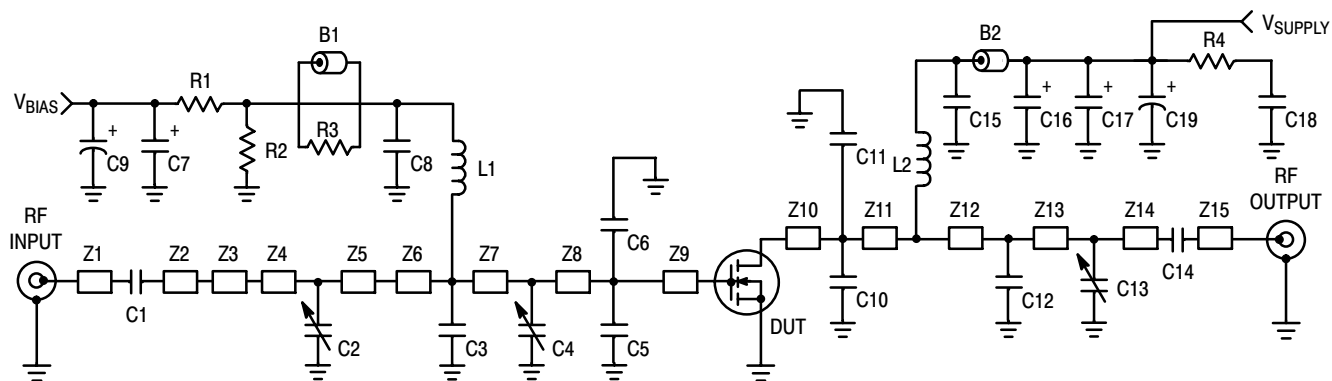

Z1	0.215" x 0.065" Microstrip	Z9	0.057" x 0.525" Microstrip
Z2	0.221" x 0.065" Microstrip	Z10	0.360" x 0.270" Microstrip
Z3	0.500" x 0.100" Microstrip	Z11	0.063" x 0.270" Microstrip
Z4	0.460" x 0.270" Microstrip	Z12	0.360" x 0.065" Microstrip
Z5	0.040" x 0.270" Microstrip	Z13	0.170" x 0.065" Microstrip
Z6	0.280" x 0.270" x 0.530" Taper	Z14	0.880" x 0.065" Microstrip
Z7	0.087" x 0.525" Microstrip	Z15	0.260" x 0.065" Microstrip
Z8	0.435" x 0.525" Microstrip	PCB	Taconic RF-35 0.030", $\epsilon_r = 3.5$

Figure 1. MRFE6S9060NR1 Test Circuit Schematic

Table 6. MRFE6S9060NR1 Test Circuit Component Designations and Values

Part	Description	Part Number	Manufacturer
B1	Ferrite Bead	2743019447	Fair Rite
B2	Ferrite Bead	274021447	Fair Rite
C1, C8, C14, C15	47 pF Chip Capacitors	ATC100B470JT500XT	ATC
C2, C4, C13	0.8 - 8.0 pF Variable Capacitors, Gigatrim	2729152	Johanson
C3	3.0 pF Chip Capacitor	ATC100B3R0JT500XT	ATC
C5, C6	15 pF Chip Capacitors	ATC100B150JT500XT	ATC
C7, C16, C17	10 μ F, 35 V Tantalum Capacitors	T491D106K035AT	Kemet
C9	100 μ F, 50 V Electrolytic Capacitor	MCHT101M1HB-1017-RH	Multicomp
C10, C11	12 pF Chip Capacitors	ATC100B120JT500XT	ATC
C12	4.3 pF Chip Capacitor	ATC100B4R3JT500XT	ATC
C18	0.56 μ F Chip Capacitor	ATC700A561MT150XT	ATC
C19	470 μ F, 63 V Electrolytic Capacitor	EKME630ELL471MK255	Multicomp
L1, L2	12.5 nH Inductor	A04T-5	Coilcraft
R1	1 k Ω , 1/4 W Chip Resistor	CRCW12061001FKEA	Vishay
R2	560 k Ω , 1/4 W Chip Resistor	CRCW12065600FKEA	Vishay
R3	12 Ω , 1/4 W Chip Resistor	CRCW120612R0FKEA	Vishay
R4	27 Ω , 1/4 W Chip Resistor	CRCW120627R0FKEA	Vishay

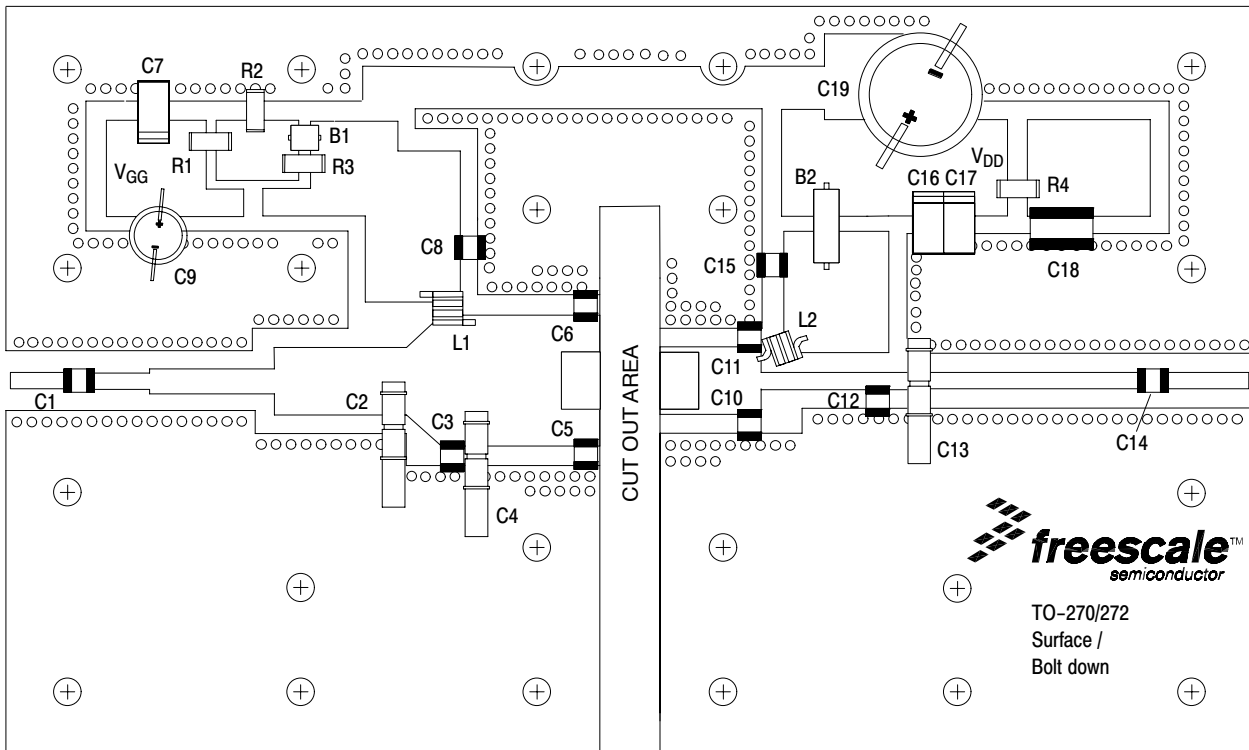

Figure 2. MRFE6S9060NR1 Test Circuit Component Layout

TYPICAL CHARACTERISTICS

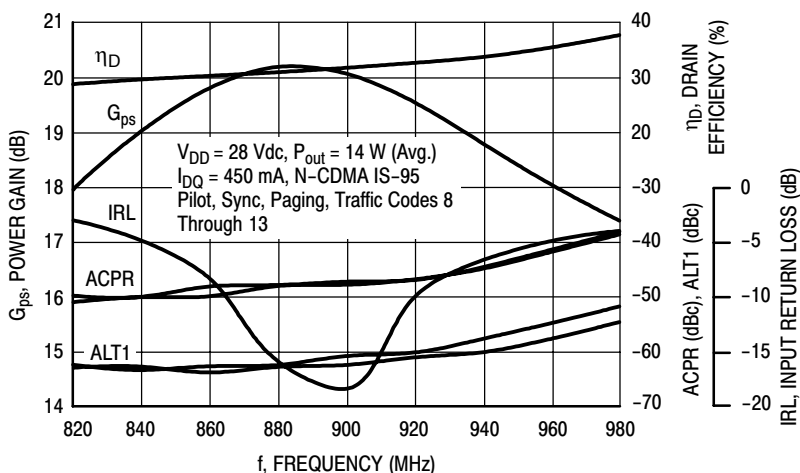

Figure 3. Single-Carrier N-CDMA Broadband Performance @ $P_{out} = 14$ Watts Avg.

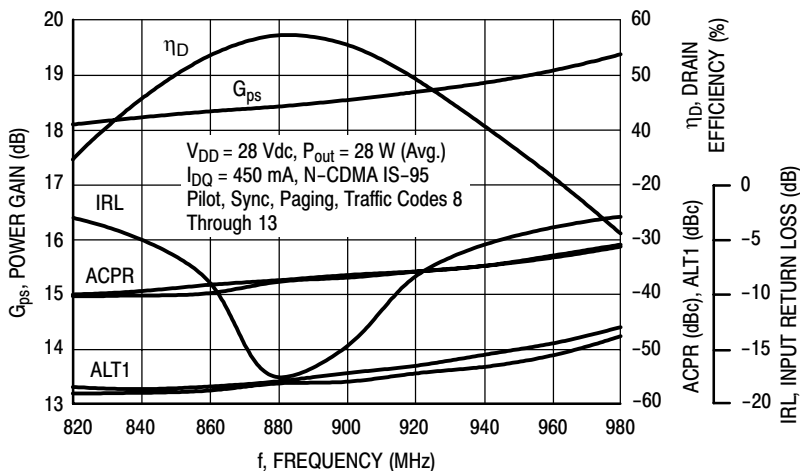

Figure 4. Single-Carrier N-CDMA Broadband Performance @ $P_{out} = 28$ Watts Avg.

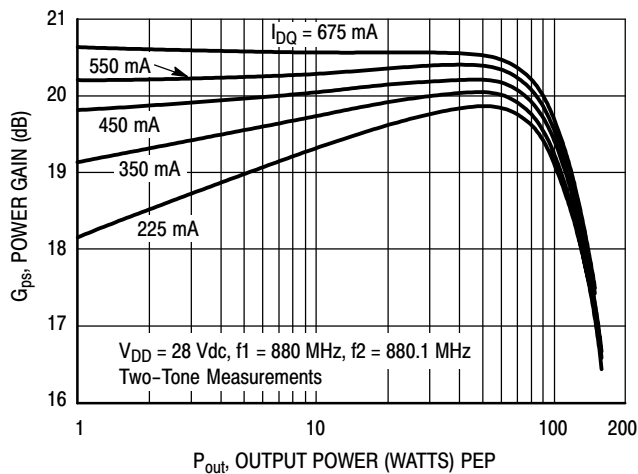

Figure 5. Two-Tone Power Gain versus Output Power

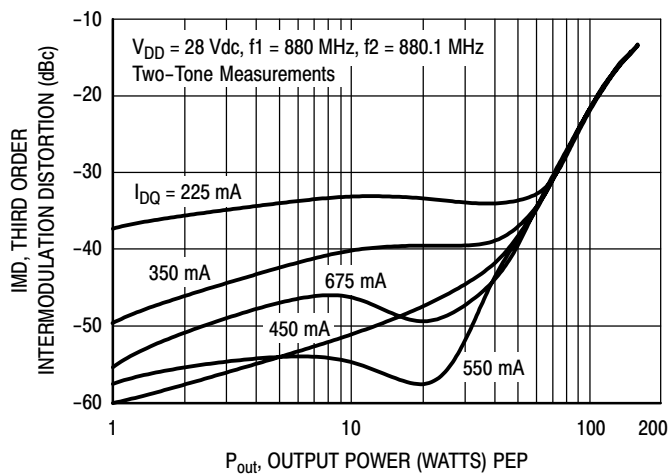

Figure 6. Third Order Intermodulation Distortion versus Output Power

TYPICAL CHARACTERISTICS

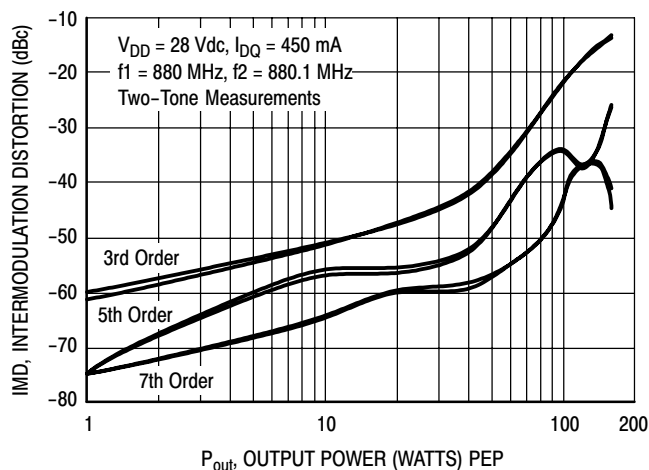

Figure 7. Intermodulation Distortion Products versus Output Power

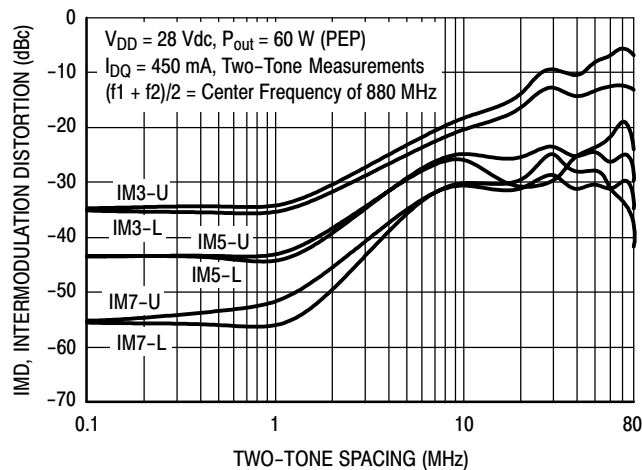

Figure 8. Intermodulation Distortion Products versus Tone Spacing

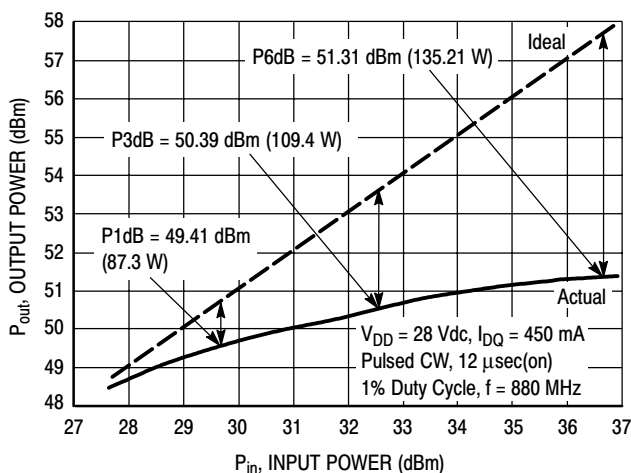

Figure 9. Pulsed CW Output Power versus Input Power

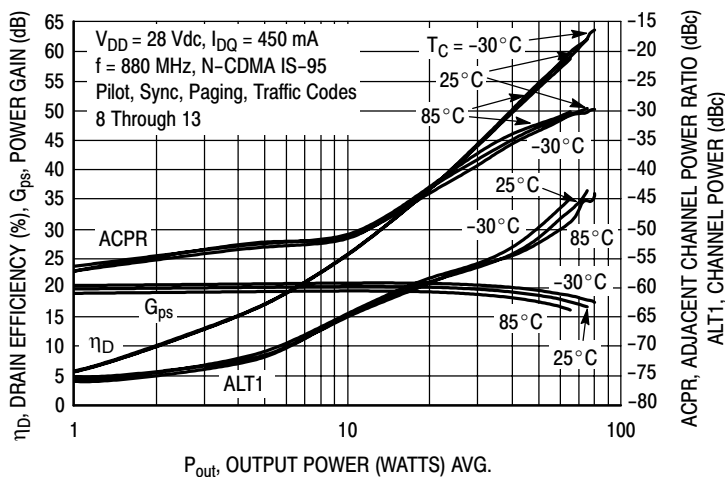

Figure 10. Single-Carrier N-CDMA ACPR, ALT1, Power Gain and Drain Efficiency versus Output Power

TYPICAL CHARACTERISTICS

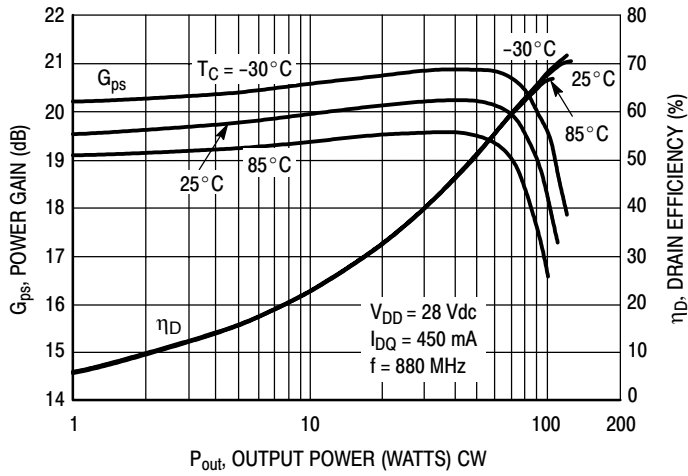

Figure 11. Power Gain and Drain Efficiency versus CW Output Power

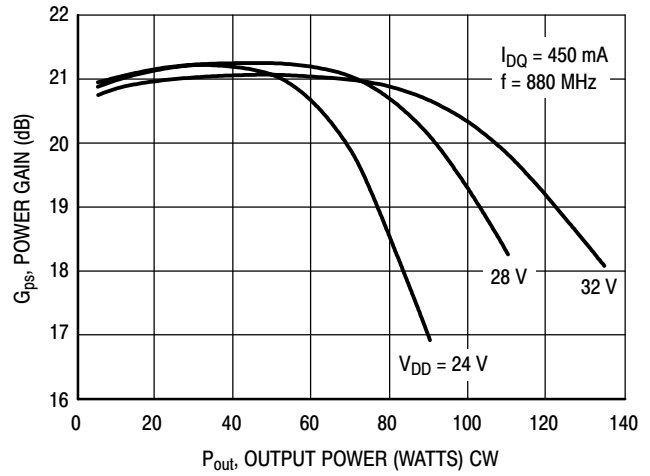
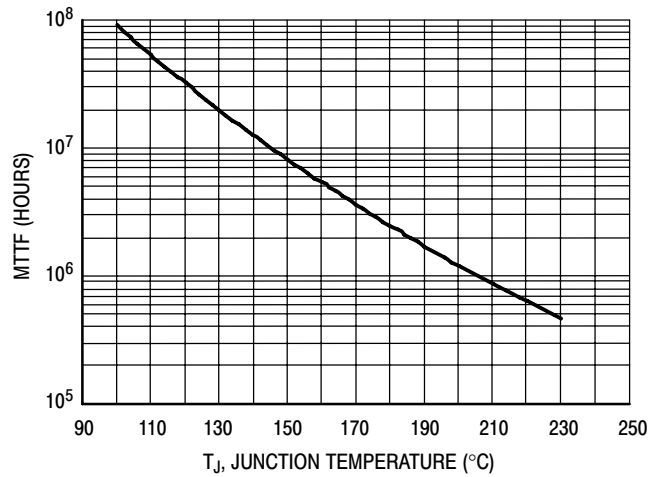

Figure 12. Power Gain versus Output Power



This above graph displays calculated MTTF in hours when the device is operated at $V_{DD} = 28 \text{ Vdc}$, $P_{out} = 14 \text{ W Avg.}$, and $\eta_D = 32.5\%$.

MTTF calculator available at <http://www.freescale.com/rf>. Select Tools (Software & Tools)/Calculators to access MTTF calculators by product.

Figure 13. MTTF versus Junction Temperature

N-CDMA TEST SIGNAL

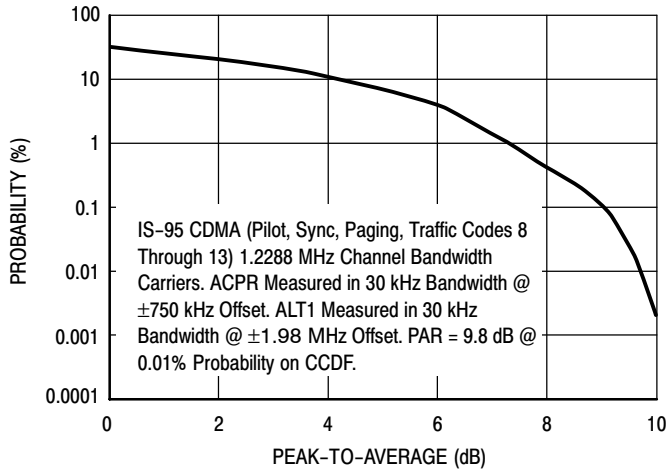

Figure 14. Single-Carrier CCDF N-CDMA

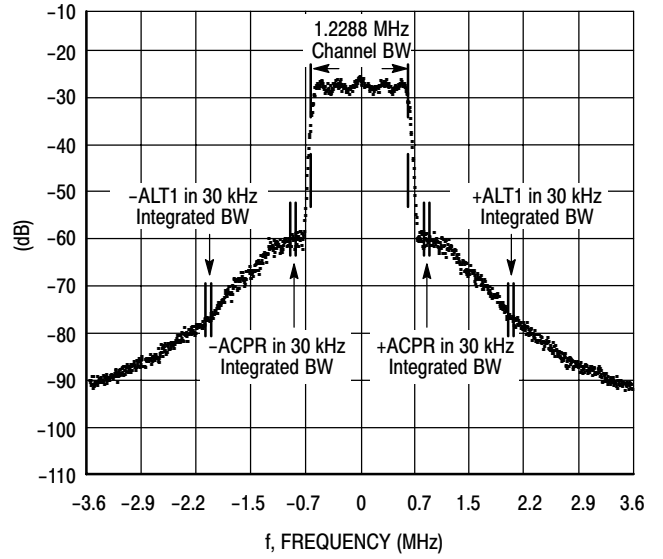
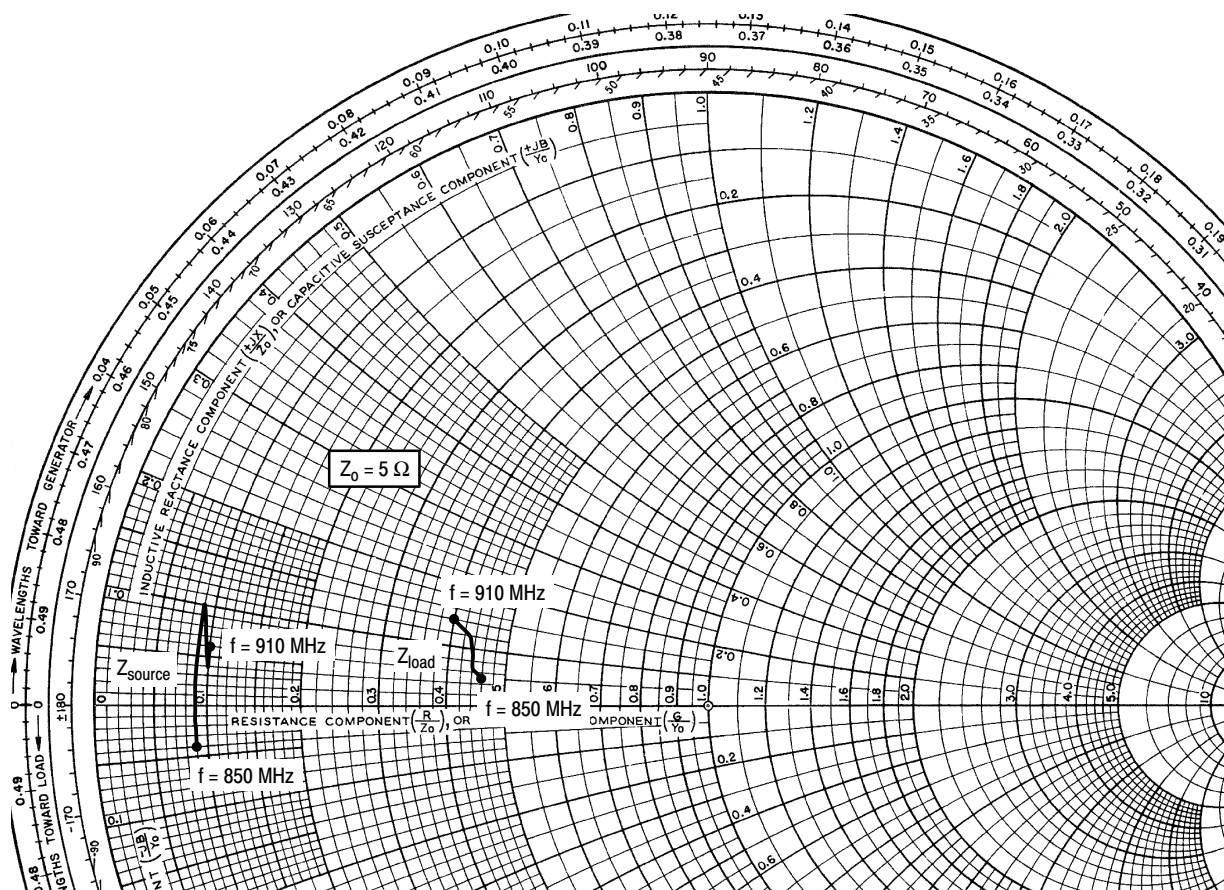

Figure 15. Single-Carrier N-CDMA Spectrum



$V_{DD} = 28 \text{ Vdc}$, $I_{DQ} = 450 \text{ mA}$, $P_{out} = 14 \text{ W Avg.}$

f MHz	Z_{source} Ω	Z_{load} Ω
850	$0.44 - j0.20$	$2.28 + j0.23$
865	$0.44 - j0.07$	$2.18 + j0.33$
880	$0.45 + j0.50$	$2.20 + j0.47$
895	$0.48 + j0.18$	$2.15 + j0.61$
910	$0.52 + j0.29$	$2.00 + j0.68$

Z_{source} = Test circuit impedance as measured from gate to ground.

Z_{load} = Test circuit impedance as measured from drain to ground.

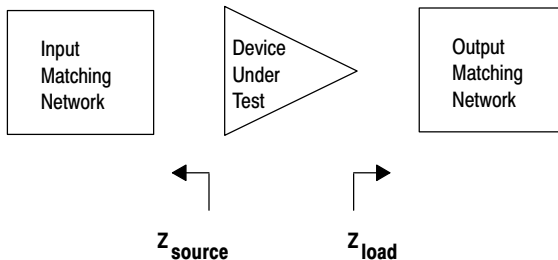
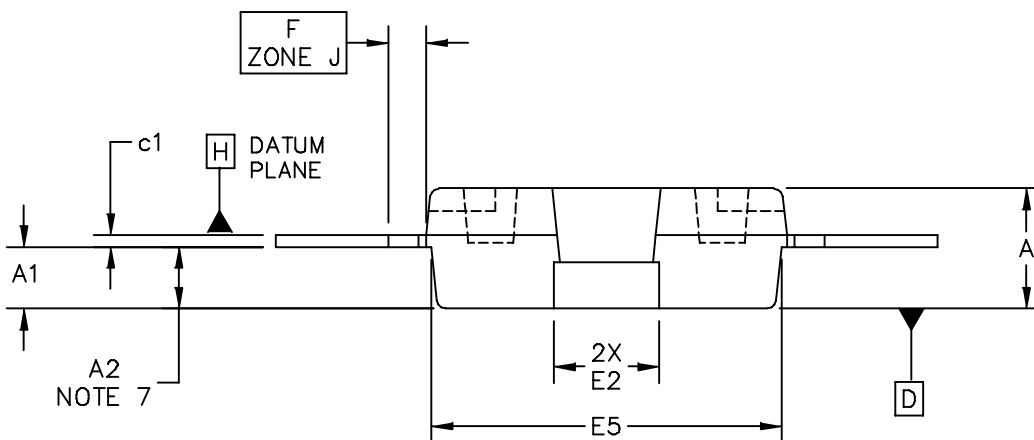
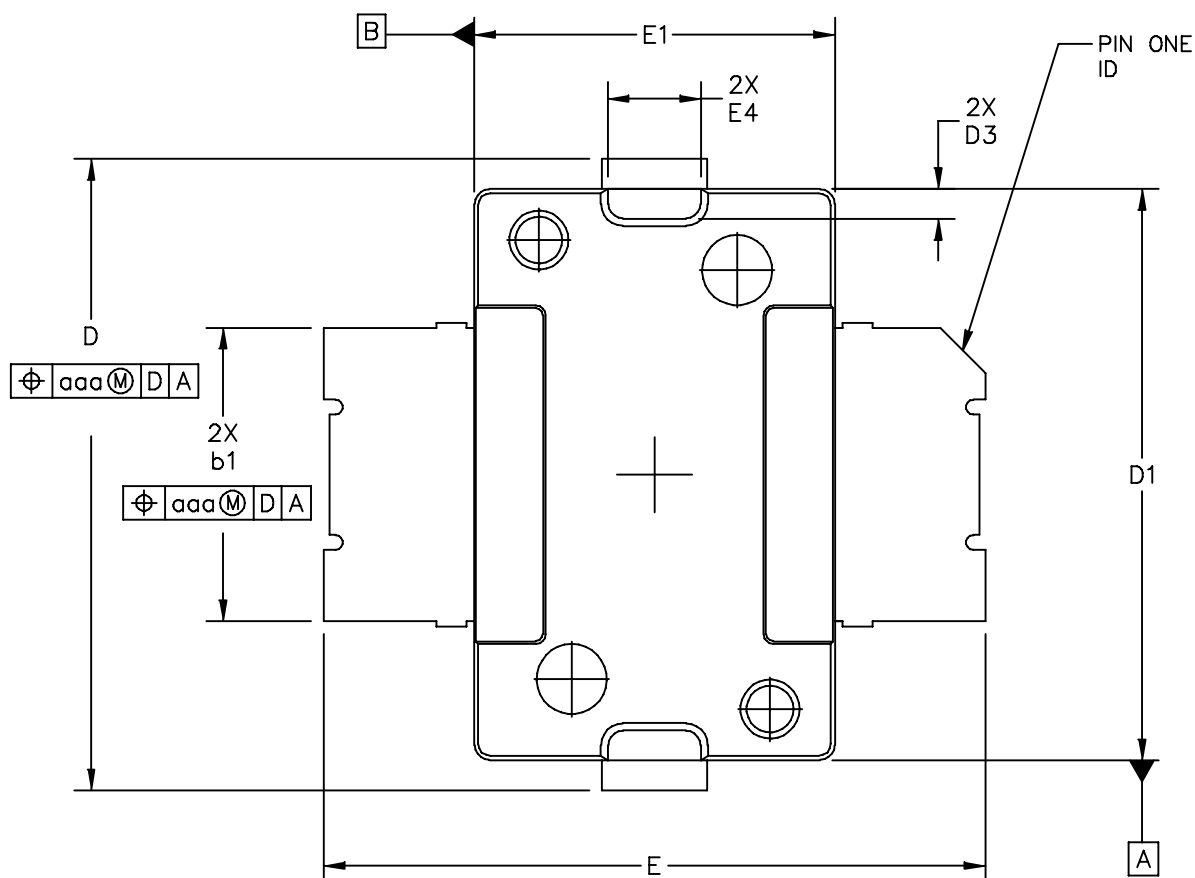
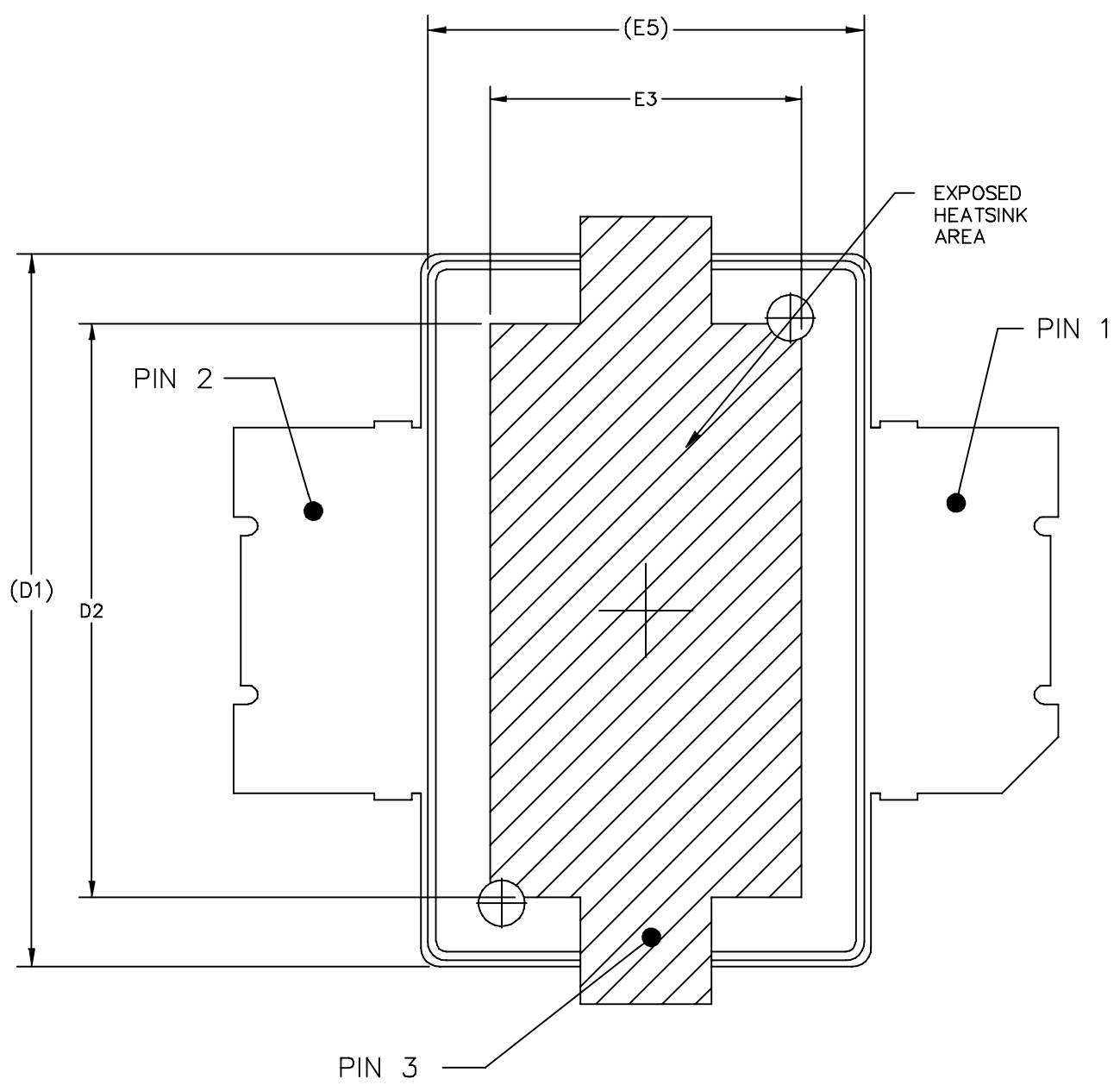

Figure 16. Series Equivalent Source and Load Impedance

PACKAGE DIMENSIONS



© FREESCALE SEMICONDUCTOR, INC. ALL RIGHTS RESERVED.	MECHANICAL OUTLINE	PRINT VERSION NOT TO SCALE	
TITLE: TO-270 SURFACE MOUNT	DOCUMENT NO: 98ASH98117A	REV: K	
	CASE NUMBER: 1265-09	29 JUN 2007	
	STANDARD: JEDEC TO-270 AA		



BOTTOM VIEW

© FREESCALE SEMICONDUCTOR, INC. ALL RIGHTS RESERVED.	MECHANICAL OUTLINE	PRINT VERSION NOT TO SCALE	
TITLE: TO-270 SURFACE MOUNT	DOCUMENT NO: 98ASH98117A	REV: K	
	CASE NUMBER: 1265-09	29 JUN 2007	
	STANDARD: JEDEC TO-270 AA		

NOTES:

1. CONTROLLING DIMENSION: INCH
2. INTERPRET DIMENSIONS AND TOLERANCES PER ASME Y14.5M-1994.
3. DATUM PLANE -H- IS LOCATED AT TOP OF LEAD AND IS COINCIDENT WITH THE LEAD WHERE THE LEAD EXITS THE PLASTIC BODY AT THE TOP OF THE PARTING LINE.
4. DIMENSIONS "D1" AND "E1" DO NOT INCLUDE MOLD PROTRUSION. ALLOWABLE PROTRUSION IS .006 PER SIDE. DIMENSIONS "D1 AND "E1" DO INCLUDE MOLD MISMATCH AND ARE DETERMINED AT DATUM PLANE -H-.
5. DIMENSION "b1" DOES NOT INCLUDE DAMBAR PROTRUSION. ALLOWABLE DAMBAR PROTRUSION SHALL BE .005 TOTAL IN EXCESS OF THE "b1" DIMENSION AT MAXIMUM MATERIAL CONDITION.
6. DATUMS -A- AND -B- TO BE DETERMINED AT DATUM PLANE -H-.
7. DIMENSION "A2" APPLIES WITHIN ZONE "J" ONLY.
8. DIMENSIONS "D" AND "E2" DO NOT INCLUDE MOLD PROTRUSION. OVERALL LENGTH INCLUDING MOLD PROTRUSION SHOULD NOT EXCEED 0.430 INCH FOR DIMENSION "D" AND 0.080 INCH FOR DIMENSION "E2". DIMENSIONS "D" AND "E2" DO INCLUDE MOLD MISMATCH AND ARE DETERMINED AT DATUM PLANE -D-.

STYLE 1:

- PIN 1 - DRAIN
- PIN 2 - GATE
- PIN 3 - SOURCE

DIM	INCH		MILLIMETER		DIM	INCH		MILLIMETER	
	MIN	MAX	MIN	MAX		MIN	MAX	MIN	MAX
A	.078	.082	1.98	2.08	F	.025 BSC		0.64 BSC	
A1	.039	.043	0.99	1.09	b1	.193	.199	4.90	5.06
A2	.040	.042	1.02	1.07	c1	.007	.011	0.18	0.28
D	.416	.424	10.57	10.77	aaa	.004		0.10	
D1	.378	.382	9.60	9.70					
D2	.290	----	7.37	----					
D3	.016	.024	0.41	0.61					
E	.436	.444	11.07	11.28					
E1	.238	.242	6.04	6.15					
E2	.066	.074	1.68	1.88					
E3	.150	----	3.81	----					
E4	.058	.066	1.47	1.68					
E5	.231	.235	5.87	5.97					
© FREESCALE SEMICONDUCTOR, INC. ALL RIGHTS RESERVED.			MECHANICAL OUTLINE			PRINT VERSION NOT TO SCALE			
TITLE: TO-270 SURFACE MOUNT					DOCUMENT NO: 98ASH98117A			REV: K	
					CASE NUMBER: 1265-09			29 JUN 2007	
					STANDARD: JEDEC TO-270 AA				

PRODUCT DOCUMENTATION

Refer to the following documents to aid your design process.

Application Notes

- AN1907: Solder Reflow Attach Method for High Power RF Devices in Plastic Packages
- AN1955: Thermal Measurement Methodology of RF Power Amplifiers
- AN3263: Bolt Down Mounting Method for High Power RF Transistors and RFICs in Over-Molded Plastic Packages

Engineering Bulletins

- EB212: Using Data Sheet Impedances for RF LDMOS Devices

REVISION HISTORY

The following table summarizes revisions to this document.

Revision	Date	Description
0	Oct. 2007	<ul style="list-style-type: none"> • Initial Release of Data Sheet
1	Oct. 2007	<ul style="list-style-type: none"> • Added Min value to $V_{DS(on)}$. On Characteristics table, p. 2

How to Reach Us:

Home Page:

www.freescale.com

Web Support:

<http://www.freescale.com/support>

USA/Europe or Locations Not Listed:

Freescale Semiconductor, Inc.
Technical Information Center, EL516
2100 East Elliot Road
Tempe, Arizona 85284
+1-800-521-6274 or +1-480-768-2130
www.freescale.com/support

Europe, Middle East, and Africa:

Freescale Halbleiter Deutschland GmbH
Technical Information Center
Schatzbogen 7
81829 Muenchen, Germany
+44 1296 380 456 (English)
+46 8 52200080 (English)
+49 89 92103 559 (German)
+33 1 69 35 48 48 (French)
www.freescale.com/support

Japan:

Freescale Semiconductor Japan Ltd.
Headquarters
ARCO Tower 15F
1-8-1, Shimo-Meguro, Meguro-ku,
Tokyo 153-0064
Japan
0120 191014 or +81 3 5437 9125
support.japan@freescale.com

Asia/Pacific:

Freescale Semiconductor Hong Kong Ltd.
Technical Information Center
2 Dai King Street
Tai Po Industrial Estate
Tai Po, N.T., Hong Kong
+800 2666 8080
support.asia@freescale.com

For Literature Requests Only:

Freescale Semiconductor Literature Distribution Center
P.O. Box 5405
Denver, Colorado 80217
1-800-441-2447 or 303-675-2140
Fax: 303-675-2150
LDCForFreescaleSemiconductor@hibbertgroup.com

Information in this document is provided solely to enable system and software implementers to use Freescale Semiconductor products. There are no express or implied copyright licenses granted hereunder to design or fabricate any integrated circuits or integrated circuits based on the information in this document.



Freescale Semiconductor reserves the right to make changes without further notice to any products herein. Freescale Semiconductor makes no warranty, representation or guarantee regarding the suitability of its products for any particular purpose, nor does Freescale Semiconductor assume any liability arising out of the application or use of any product or circuit, and specifically disclaims any and all liability, including without limitation consequential or incidental damages. "Typical" parameters that may be provided in Freescale Semiconductor data sheets and/or specifications can and do vary in different applications and actual performance may vary over time. All operating parameters, including "Typicals", must be validated for each customer application by customer's technical experts. Freescale Semiconductor does not convey any license under its patent rights nor the rights of others. Freescale Semiconductor products are not designed, intended, or authorized for use as components in systems intended for surgical implant into the body, or other applications intended to support or sustain life, or for any other application in which the failure of the Freescale Semiconductor product could create a situation where personal injury or death may occur. Should Buyer purchase or use Freescale Semiconductor products for any such unintended or unauthorized application, Buyer shall indemnify and hold Freescale Semiconductor and its officers, employees, subsidiaries, affiliates, and distributors harmless against all claims, costs, damages, and expenses, and reasonable attorney fees arising out of, directly or indirectly, any claim of personal injury or death associated with such unintended or unauthorized use, even if such claim alleges that Freescale Semiconductor was negligent regarding the design or manufacture of the part.

Freescale™ and the Freescale logo are trademarks of Freescale Semiconductor, Inc. All other product or service names are the property of their respective owners.

© Freescale Semiconductor, Inc. 2007. All rights reserved.

Looking for pricing, stock, or lifecycle information?

Click below to explore more details on WIN SOURCE:

-  [View MRFE6S9060NR1 on WIN SOURCE](#)
-  [Freescale Semiconductor - NXP Information](#)

Optimize Your Supply Chain with WIN SOURCE Solutions

-  Global Sourcing Solution
-  Obsolete Management
-  Cost Control Management
-  Shortage Management
-  Alternative Solution
-  Excess Inventory Management