



THE DATASHEET OF MRFE6S9205HSR3



RF Power Field Effect Transistors

N-Channel Enhancement-Mode Lateral MOSFETs

Designed for broadband commercial and industrial applications with frequencies up to 1000 MHz. The high gain and broadband performance of these devices make them ideal for large-signal, common-source amplifier applications in 28 volt base station equipment.

- Typical Single-Carrier W-CDMA Performance: $V_{DD} = 28$ Volts, $I_{DQ} = 1400$ mA, $P_{out} = 58$ Watts Avg., Full Frequency Band, 3GPP Test Model 1, 64 DPCH with 50% Clipping, Channel Bandwidth = 3.84 MHz, Input Signal PAR = 7.5 dB @ 0.01% Probability on CCDF.
 Power Gain — 21.2 dB
 Drain Efficiency — 34%
 Device Output Signal PAR — 6.3 dB @ 0.01% Probability on CCDF
 ACPR @ 5 MHz Offset — -39.1 dBc in 3.84 MHz Channel Bandwidth
- Capable of Handling 10:1 VSWR, @ 32 Vdc, 880 MHz, $P_{out} = 260$ W CW (3 dB Input Overdrive from Rated P_{out}), Designed for Enhanced Ruggedness

Features

- 100% PAR Tested for Guaranteed Output Power Capability
- Characterized with Series Equivalent Large-Signal Impedance Parameters
- Internally Matched for Ease of Use
- Qualified Up to a Maximum of 32 V_{DD} Operation
- Integrated ESD Protection
- Optimized for Doherty Applications
- RoHS Compliant
- In Tape and Reel. R3 Suffix = 250 Units per 56 mm, 13 inch Reel.

MRFE6S9205HR3
MRFE6S9205HSR3

880 MHz, 58 W AVG., 28 V
SINGLE W-CDMA
LATERAL N-CHANNEL
RF POWER MOSFETs

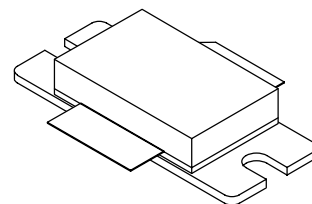

CASE 465B-03, STYLE 1
NI-880
MRFE6S9205HR3

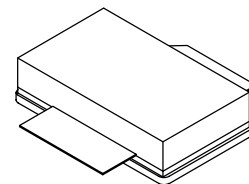

CASE 465C-02, STYLE 1
NI-880S
MRFE6S9205HSR3

Table 1. Maximum Ratings

| Rating | Symbol | Value | Unit |
|--------------------------------------|-----------|--------------|------|
| Drain-Source Voltage | V_{DSS} | -0.5, +66 | Vdc |
| Gate-Source Voltage | V_{GS} | -0.5, +12 | Vdc |
| Storage Temperature Range | T_{stg} | - 65 to +150 | °C |
| Case Operating Temperature | T_C | 150 | °C |
| Operating Junction Temperature (1,2) | T_J | 225 | °C |

Table 2. Thermal Characteristics

| Characteristic | Symbol | Value (2,3) | Unit |
|---|-----------------|--------------|------|
| Thermal Resistance, Junction to Case Case Temperature 80°C, 202 W CW Case Temperature 77°C, 58 W CW | $R_{\theta JC}$ | 0.27 0.33 | °C/W |

1. Continuous use at maximum temperature will affect MTTF.
2. MTTF calculator available at <http://www.freescale.com/rf>. Select Tools (Software & Tools)/Calculators to access the MTTF calculators by product.
3. Refer to AN1955, *Thermal Measurement Methodology of RF Power Amplifiers*. Go to <http://www.freescale.com/rf>. Select Documentation/Application Notes - AN1955.

Table 3. ESD Protection Characteristics

| Test Methodology | Class |
|---------------------------------------|--------------------|
| Human Body Model (per JESD22-A114) | Class 1C (Minimum) |
| Machine Model (per EIA/JESD22-A115) | Class B (Minimum) |
| Charge Device Model (per JESD22-C101) | Class IV (Minimum) |

Table 4. Electrical Characteristics ($T_C = 25^\circ\text{C}$ unless otherwise noted)

| Characteristic | Symbol | Min | Typ | Max | Unit |
|---|-----------|-----|-----|-----|-----------------|
| Off Characteristics | | | | | |
| Zero Gate Voltage Drain Leakage Current ($V_{DS} = 66\text{ Vdc}$, $V_{GS} = 0\text{ Vdc}$) | I_{DSS} | — | — | 10 | μAdc |
| Zero Gate Voltage Drain Leakage Current ($V_{DS} = 28\text{ Vdc}$, $V_{GS} = 0\text{ Vdc}$) | I_{DSS} | — | — | 1 | μAdc |
| Gate-Source Leakage Current ($V_{GS} = 5\text{ Vdc}$, $V_{DS} = 0\text{ Vdc}$) | I_{GSS} | — | — | 10 | μAdc |

On Characteristics

| | | | | | |
|---|--------------|-----|-----|-----|-----|
| Gate Threshold Voltage ($V_{DS} = 10\text{ Vdc}$, $I_D = 600\ \mu\text{Adc}$) | $V_{GS(th)}$ | 1.4 | 2.1 | 2.9 | Vdc |
| Gate Quiescent Voltage ($V_{DD} = 28\text{ Vdc}$, $I_D = 1400\ \text{mAdc}$, Measured in Functional Test) | $V_{GS(Q)}$ | 2.2 | 2.9 | 3.7 | Vdc |
| Drain-Source On-Voltage ($V_{GS} = 10\text{ Vdc}$, $I_D = 4.2\ \text{Adc}$) | $V_{DS(on)}$ | 0.1 | 0.2 | 0.3 | Vdc |

Dynamic Characteristics ⁽¹⁾

| | | | | | |
|--|-----------|---|------|---|----|
| Reverse Transfer Capacitance ($V_{DS} = 28\text{ Vdc} \pm 30\ \text{mV(rms)ac}$ @ 1 MHz, $V_{GS} = 0\text{ Vdc}$) | C_{rss} | — | 1.63 | — | pF |
| Output Capacitance ($V_{DS} = 28\text{ Vdc} \pm 30\ \text{mV(rms)ac}$ @ 1 MHz, $V_{GS} = 0\text{ Vdc}$) | C_{oss} | — | 590 | — | pF |
| Input Capacitance ($V_{DS} = 28\text{ Vdc}$, $V_{GS} = 0\text{ Vdc} \pm 30\ \text{mV(rms)ac}$ @ 1 MHz) | C_{iss} | — | 491 | — | pF |

Functional Tests (In Freescale Test Fixture, 50 ohm system) $V_{DD} = 28\text{ Vdc}$, $I_{DQ} = 1400\ \text{mA}$, $P_{out} = 58\ \text{W Avg. W-CDMA}$, $f = 880\ \text{MHz}$, Single-Carrier W-CDMA, 3.84 MHz Channel Bandwidth Carrier. ACPR measured in 3.84 MHz Channel Bandwidth @ 5 MHz Offset. PAR = 7.5 dB @ 0.01% Probability on CCDF.

| | | | | | |
|--|----------|----|-------|-------|-----|
| Power Gain | G_{ps} | 20 | 21.2 | 23 | dB |
| Drain Efficiency | η_D | 32 | 34 | — | % |
| Output Peak-to-Average Ratio @ 0.01% Probability on CCDF | PAR | 6 | 6.3 | — | dB |
| Adjacent Channel Power Ratio | ACPR | — | -39.1 | -37.5 | dBc |
| Input Return Loss | IRL | — | -12.5 | -8.5 | dB |

1. Part is internally matched on input.

(continued)

Table 4. Electrical Characteristics ($T_C = 25^\circ\text{C}$ unless otherwise noted) (continued)

| Characteristic | Symbol | Min | Typ | Max | Unit |
|---|------------------|-----|-------|-----|--------|
| Typical Performances (In Freescale Test Fixture, 50 ohm system) $V_{DD} = 28\text{ Vdc}$, $I_{DQ} = 1400\text{ mA}$, 865-900 MHz Bandwidth | | | | | |
| Video Bandwidth @ 220 W PEP P_{out} where $IM_3 = -30\text{ dBc}$ (Tone Spacing from 100 kHz to VBW) $\Delta IMD_3 = IMD_3 @ \text{VBW}$ frequency - $IMD_3 @ 100\text{ kHz} < 1\text{ dBc}$ (both sidebands) | VBW | — | 10 | — | MHz |
| Gain Flatness in 35 MHz Bandwidth @ $P_{out} = 58\text{ W Avg.}$ | G_F | — | 0.315 | — | dB |
| Average Deviation from Linear Phase in 35 MHz Bandwidth @ $P_{out} = 200\text{ W CW}$ | Φ | — | 0.59 | — | ° |
| Average Group Delay @ $P_{out} = 200\text{ W CW}$, $f = 880\text{ MHz}$ | Delay | — | 4.27 | — | ns |
| Part-to-Part Insertion Phase Variation @ $P_{out} = 200\text{ W CW}$, $f = 880\text{ MHz}$, Six Sigma Window | $\Delta\Phi$ | — | 26.3 | — | ° |
| Gain Variation over Temperature (-30°C to $+85^\circ\text{C}$) | ΔG | — | 0.016 | — | dB/°C |
| Output Power Variation over Temperature (-30°C to $+85^\circ\text{C}$) | ΔP_{1dB} | — | 0.006 | — | dBm/°C |

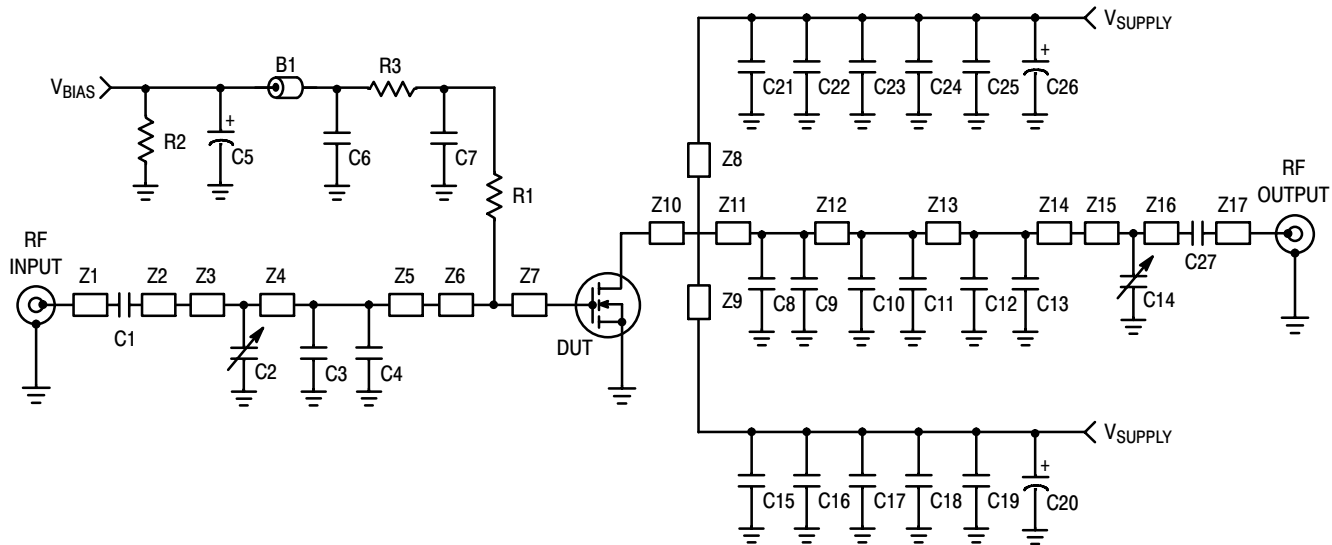

| | | | |
|--------|--------------------------------|-----|---|
| Z1 | 0.263" x 0.065" Microstrip | Z11 | 0.150" x 0.980" Microstrip |
| Z2 | 0.310" x 0.065" Microstrip | Z12 | 0.200" x 0.980" x 0.387" Taper |
| Z3 | 0.711" x 0.120" Microstrip | Z13 | 0.115" x 0.444" Microstrip |
| Z4 | 0.199" x 0.120" Microstrip | Z14 | 0.140" x 0.444" x 0.110" Taper |
| Z5 | 0.263" x 1.020" x 0.120" Taper | Z15 | 0.770" x 0.110" Microstrip |
| Z6 | 0.351" x 1.020" Microstrip | Z16 | 0.442" x 0.065" Microstrip |
| Z7 | 0.055" x 1.020" Microstrip | Z17 | 0.274" x 0.065" Microstrip |
| Z8, Z9 | 0.947" x 0.120" Microstrip | PCB | Taconic RF35 0.030", $\epsilon_r = 3.5$ |
| Z10 | 0.060" x 0.980" Microstrip | | |

Figure 1. MRFE6S9205HR3(HSR3) Test Circuit Schematic

Table 5. MRFE6S9205HR3(HSR3) Test Circuit Component Designations and Values

| Part | Description | Part Number | Manufacturer |
|----------------------------------|---|--------------------|------------------|
| B1 | Short RF Bead | 2743019447 | Fair-Rite |
| C1, C7, C15, C16, C21, C22, C27 | 39 pF Chip Capacitors | ATC100B390JT500XT | ATC |
| C2, C14 | 0.8-8.0 pF Variable Capacitors, Gigatrim | 27291SL | Johanson |
| C3, C4 | 5.1 pF Chip Capacitors | ATC100B5R1JT500XT | ATC |
| C5 | 33 μ F, 25 V Electrolytic Capacitor | EMVY350ADA330MF55G | Nippon Chemi-Con |
| C6, C17, C18, C19, C23, C24, C25 | 10 μ F, 50 V Chip Capacitors | GRM55DR61H106KA88B | Murata |
| C8, C9, C10, C11, C12, C13 | 6.8 pF Chip Capacitors | ATC100B6R8JT500XT | ATC |
| C20, C26 | 470 μ F, 63 V Electrolytic Capacitors | EKME630ELL471MK255 | United Chemi-Con |
| R1, R3 | 3.3 Ω , 1/3 W Chip Resistors | CRCW12103R30FKEA | Vishay |
| R2 | 2.2 k Ω , 1/4 W Chip Resistor | CRCW12062K20FKEA | Vishay |

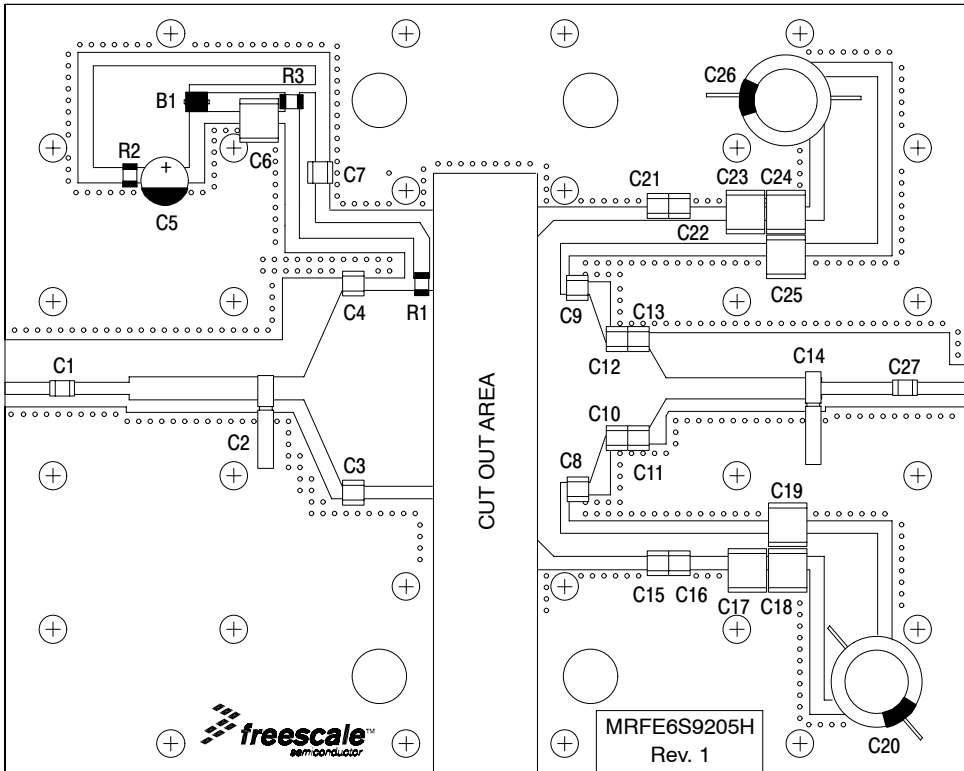

Figure 2. MRFE6S9205HR3(HSR3) Test Circuit Component Layout

TYPICAL CHARACTERISTICS

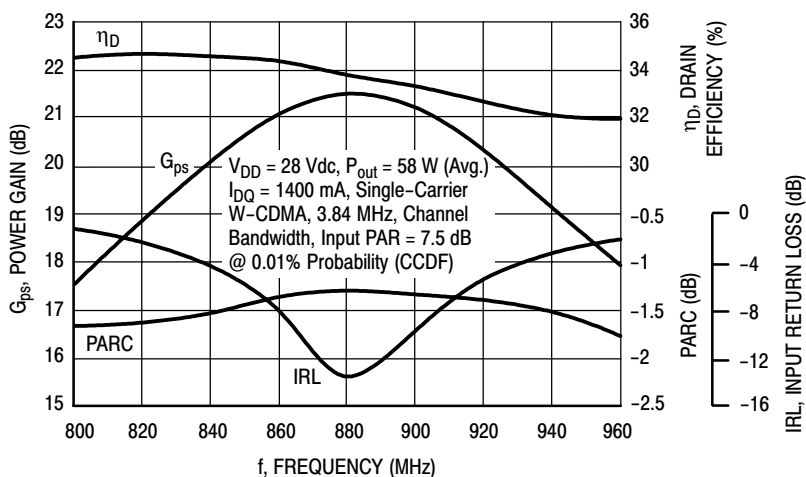

Figure 3. Output Peak-to-Average Ratio Compression (PARC) Broadband Performance @ $P_{out} = 58$ Watts Avg.

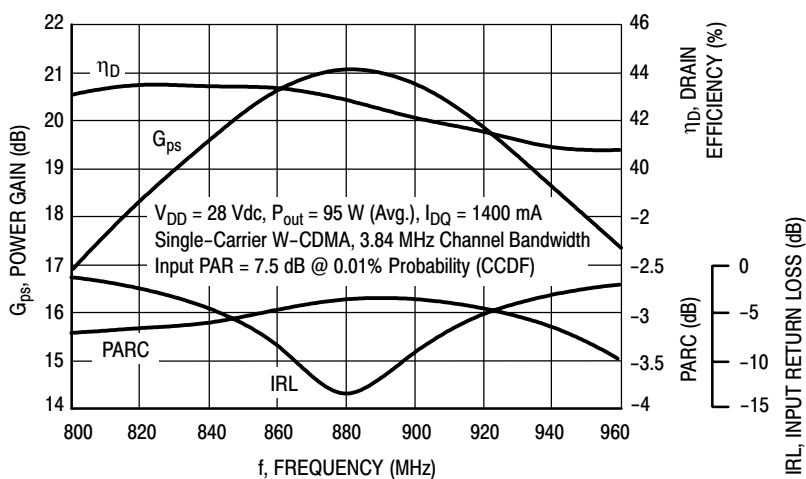

Figure 4. Output Peak-to-Average Ratio Compression (PARC) Broadband Performance @ $P_{out} = 95$ Watts Avg.

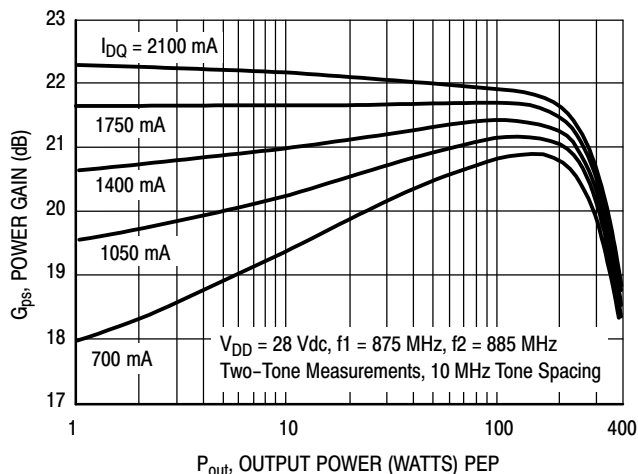

Figure 5. Two-Tone Power Gain versus Output Power

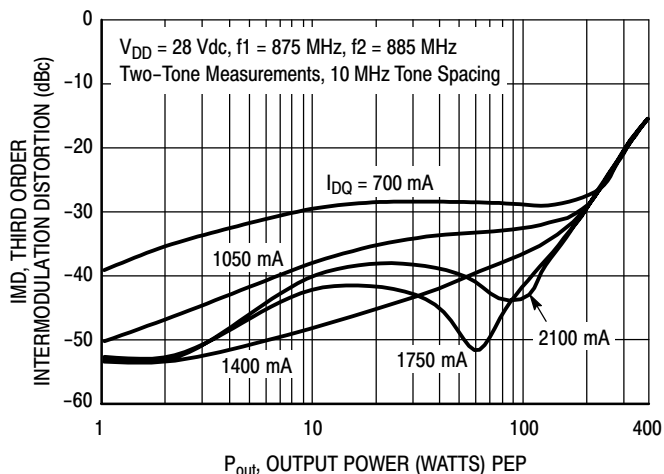

Figure 6. Third Order Intermodulation Distortion versus Output Power

TYPICAL CHARACTERISTICS

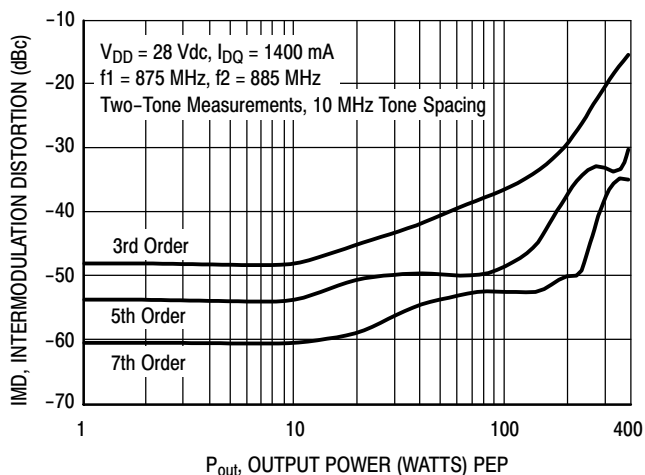

Figure 7. Intermodulation Distortion Products versus Output Power

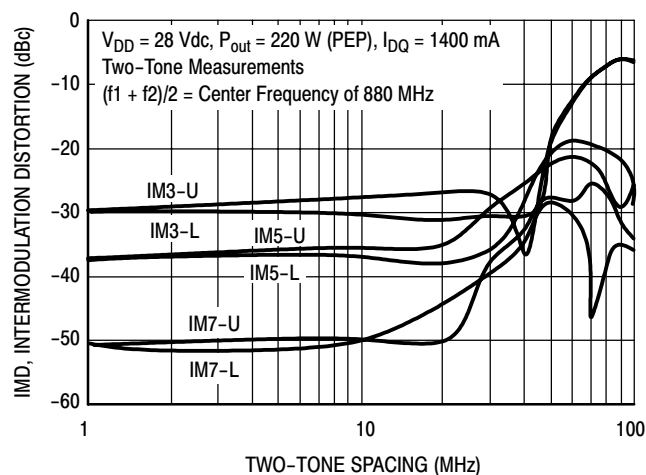

Figure 8. Intermodulation Distortion Products versus Output Power

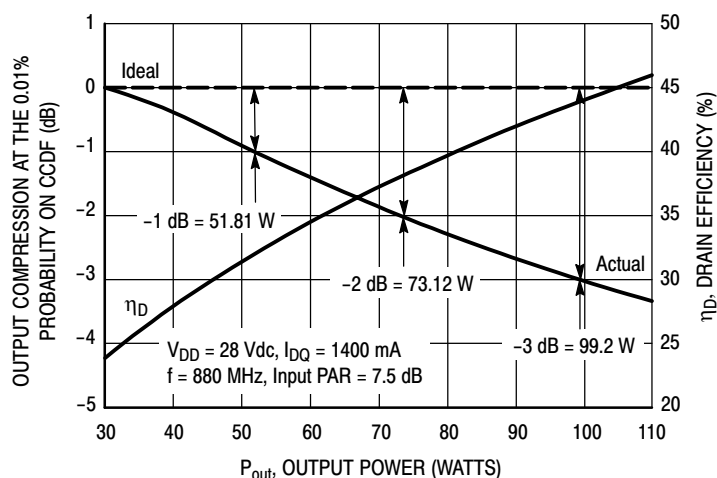

Figure 9. Output Peak-to-Average Ratio Compression (PARC) versus Output Power

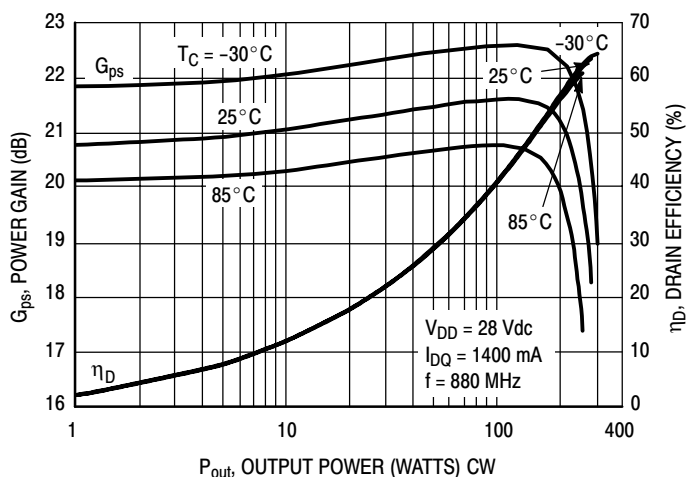

Figure 10. Power Gain and Drain Efficiency versus CW Output Power

TYPICAL CHARACTERISTICS

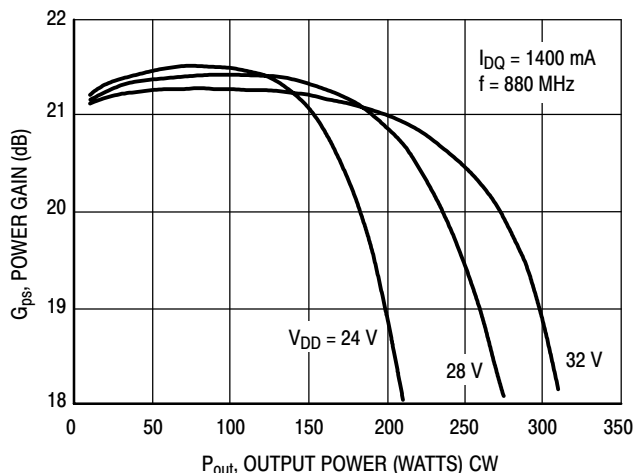
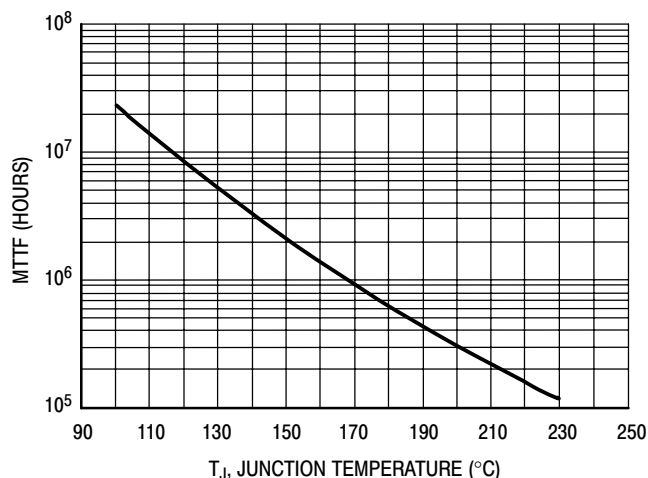

Figure 11. Power Gain versus Output Power



This above graph displays calculated MTTF in hours when the device is operated at $V_{DD} = 28$ Vdc, $P_{out} = 58$ W Avg., and $\eta_D = 34\%$.

MTTF calculator available at <http://www.freescale.com/rf>. Select Tools (Software & Tools)/Calculators to access MTTF calculators by product.

Figure 12. MTTF versus Junction Temperature

W-CDMA TEST SIGNAL

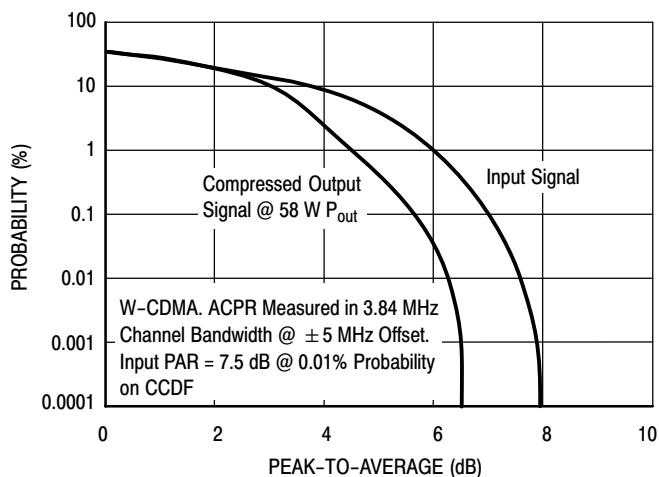

Figure 13. CCDF W-CDMA 3GPP, Test Model 1, 64 DPCH, 50% Clipping, Single-Carrier Test Signal

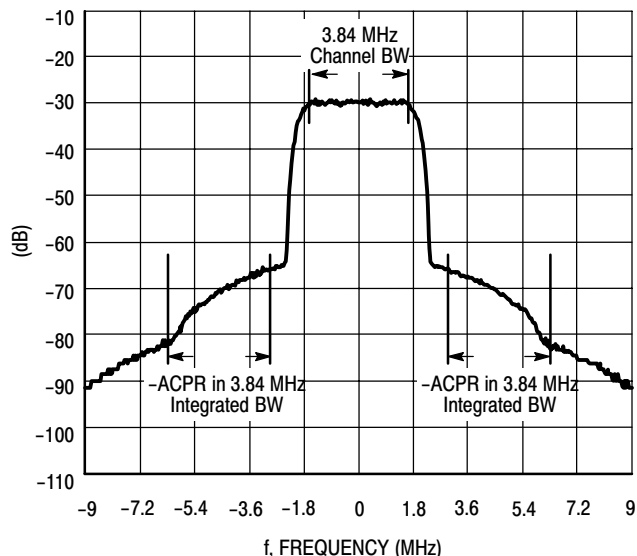
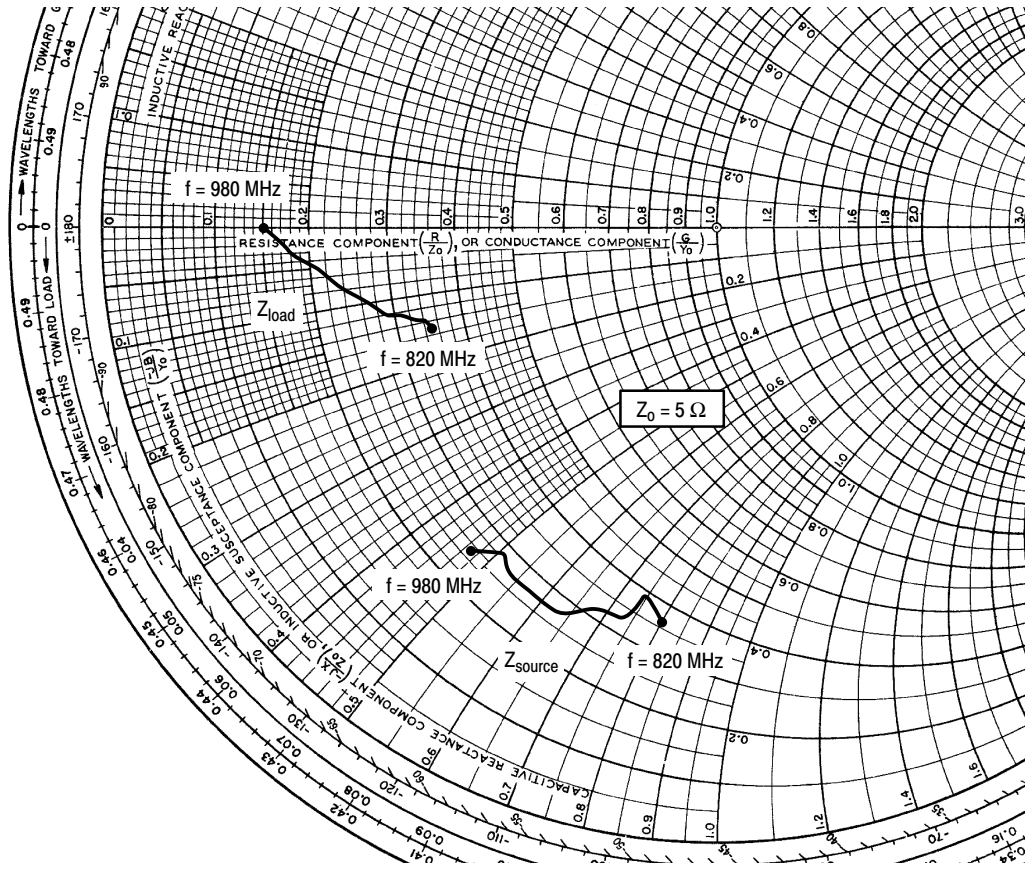

Figure 14. Single-Carrier W-CDMA Spectrum



$V_{DD} = 28 \text{ Vdc}$, $I_{DQ} = 1400 \text{ mA}$, $P_{out} = 58 \text{ W Avg.}$

| f MHz | Z_{source} Ω | Z_{load} Ω |
|----------|--------------------------|------------------------|
| 820 | $1.80 - j4.00$ | $1.75 - j0.73$ |
| 840 | $1.88 - j3.76$ | $1.68 - j0.69$ |
| 860 | $1.64 - j3.65$ | $1.57 - j0.64$ |
| 880 | $1.54 - j3.41$ | $1.44 - j0.58$ |
| 900 | $1.35 - j3.13$ | $1.33 - j0.51$ |
| 920 | $1.37 - j2.89$ | $1.21 - j0.40$ |
| 940 | $1.37 - j2.66$ | $1.07 - j0.27$ |
| 960 | $1.39 - j2.53$ | $0.92 - j0.13$ |
| 980 | $1.25 - j2.33$ | $0.74 + j0.01$ |

Z_{source} = Test circuit impedance as measured from gate to ground.

Z_{load} = Test circuit impedance as measured from drain to ground.

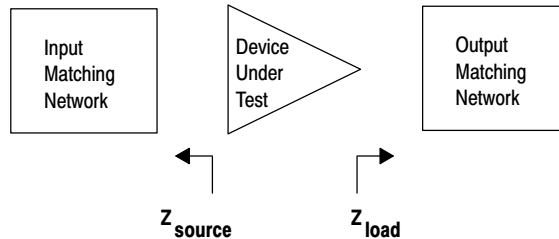
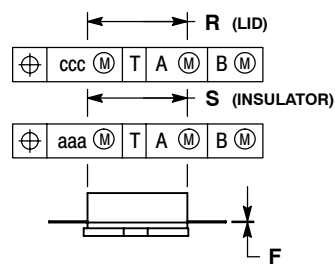
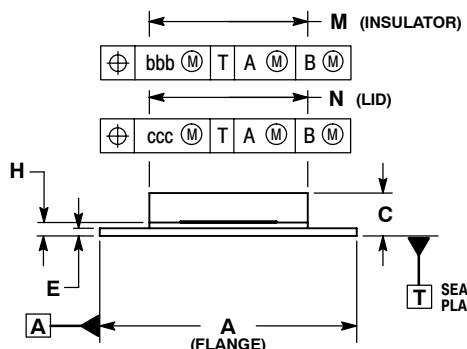
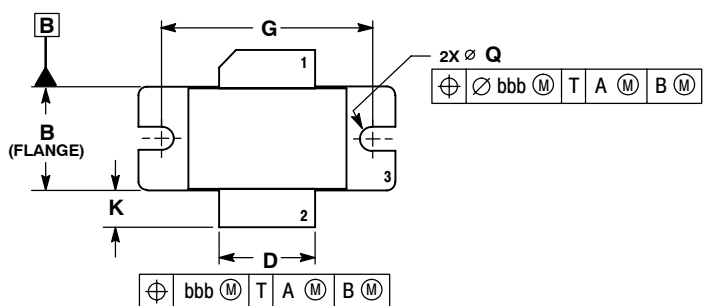

Figure 15. Series Equivalent Source and Load Impedance

PACKAGE DIMENSIONS



**CASE 465B-03
ISSUE D
NI-880
MRFE6S9205HR3**

- NOTES:
1. DIMENSIONING AND TOLERANCING PER ANSI Y14.5M-1994.
 2. CONTROLLING DIMENSION: INCH.
 3. DIMENSION H IS MEASURED 0.030 (0.762) AWAY FROM PACKAGE BODY.
 4. DELETED

| DIM | INCHES | | MILLIMETERS | |
|-----|-----------|--------|-------------|--------|
| | MIN | MAX | MIN | MAX |
| A | 1.335 | 1.345 | 33.91 | 34.16 |
| B | 0.535 | 0.545 | 13.6 | 13.8 |
| C | 0.147 | 0.200 | 3.73 | 5.08 |
| D | 0.495 | 0.505 | 12.57 | 12.83 |
| E | 0.035 | 0.045 | 0.89 | 1.14 |
| F | 0.003 | 0.006 | 0.08 | 0.15 |
| G | 1.100 BSC | | 27.94 BSC | |
| H | 0.057 | 0.067 | 1.45 | 1.70 |
| K | 0.170 | 0.210 | 4.32 | 5.33 |
| M | 0.872 | 0.888 | 22.15 | 22.55 |
| N | 0.871 | 0.889 | 19.30 | 22.60 |
| Q | Ø .118 | Ø .138 | Ø 3.00 | Ø 3.51 |
| R | 0.515 | 0.525 | 13.10 | 13.30 |
| S | 0.515 | 0.525 | 13.10 | 13.30 |
| aaa | 0.007 REF | | 0.178 REF | |
| bbb | 0.010 REF | | 0.254 REF | |
| ccc | 0.015 REF | | 0.381 REF | |

- STYLE 1:
PIN 1. DRAIN
2. GATE
3. SOURCE

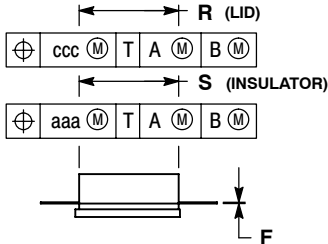
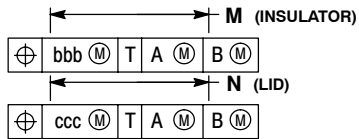
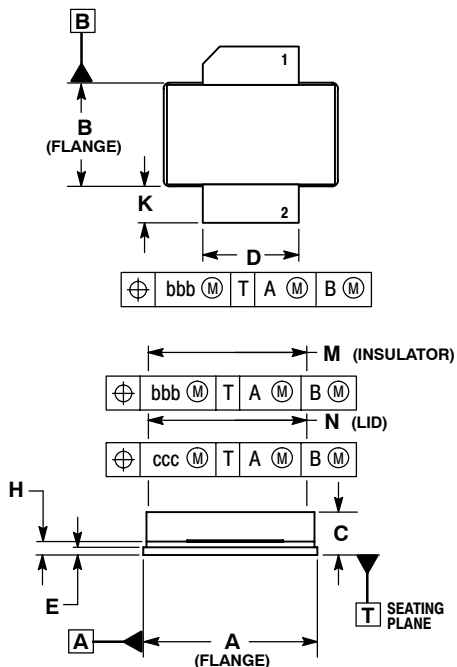

**CASE 465C-02
ISSUE D
NI-880S
MRFE6S9205HSR3**

- NOTES:
1. DIMENSIONING AND TOLERANCING PER ANSI Y14.5M-1994.
 2. CONTROLLING DIMENSION: INCH.
 3. DIMENSION H IS MEASURED 0.030 (0.762) AWAY FROM PACKAGE BODY.

| DIM | INCHES | | MILLIMETERS | |
|-----|-----------|-------|-------------|-------|
| | MIN | MAX | MIN | MAX |
| A | 0.905 | 0.915 | 22.99 | 23.24 |
| B | 0.535 | 0.545 | 13.60 | 13.80 |
| C | 0.147 | 0.200 | 3.73 | 5.08 |
| D | 0.495 | 0.505 | 12.57 | 12.83 |
| E | 0.035 | 0.045 | 0.89 | 1.14 |
| F | 0.003 | 0.006 | 0.08 | 0.15 |
| H | 0.057 | 0.067 | 1.45 | 1.70 |
| K | 0.170 | 0.210 | 4.32 | 5.33 |
| M | 0.872 | 0.888 | 22.15 | 22.55 |
| N | 0.871 | 0.889 | 19.30 | 22.60 |
| R | 0.515 | 0.525 | 13.10 | 13.30 |
| S | 0.515 | 0.525 | 13.10 | 13.30 |
| aaa | 0.007 REF | | 0.178 REF | |
| bbb | 0.010 REF | | 0.254 REF | |
| ccc | 0.015 REF | | 0.381 REF | |

- STYLE 1:
PIN 1. DRAIN
2. GATE
3. SOURCE

PRODUCT DOCUMENTATION

Refer to the following documents to aid your design process.

Application Notes

- AN1955: Thermal Measurement Methodology of RF Power Amplifiers

Engineering Bulletins

- EB212: Using Data Sheet Impedances for RF LDMOS Devices

REVISION HISTORY

The following table summarizes revisions to this document.

| Revision | Date | Description |
|----------|-----------|---|
| 0 | Oct. 2007 | <ul style="list-style-type: none"> • Initial Release of Data Sheet |

How to Reach Us:

Home Page:

www.freescale.com

Web Support:

<http://www.freescale.com/support>

USA/Europe or Locations Not Listed:

Freescale Semiconductor, Inc.
Technical Information Center, EL516
2100 East Elliot Road
Tempe, Arizona 85284
+1-800-521-6274 or +1-480-768-2130
www.freescale.com/support

Europe, Middle East, and Africa:

Freescale Halbleiter Deutschland GmbH
Technical Information Center
Schatzbogen 7
81829 Muenchen, Germany
+44 1296 380 456 (English)
+46 8 52200080 (English)
+49 89 92103 559 (German)
+33 1 69 35 48 48 (French)
www.freescale.com/support

Japan:

Freescale Semiconductor Japan Ltd.
Headquarters
ARCO Tower 15F
1-8-1, Shimo-Meguro, Meguro-ku,
Tokyo 153-0064
Japan
0120 191014 or +81 3 5437 9125
support.japan@freescale.com

Asia/Pacific:

Freescale Semiconductor Hong Kong Ltd.
Technical Information Center
2 Dai King Street
Tai Po Industrial Estate
Tai Po, N.T., Hong Kong
+800 2666 8080
support.asia@freescale.com

For Literature Requests Only:

Freescale Semiconductor Literature Distribution Center
P.O. Box 5405
Denver, Colorado 80217
1-800-441-2447 or 303-675-2140
Fax: 303-675-2150
LDCForFreescaleSemiconductor@hibbertgroup.com

Information in this document is provided solely to enable system and software implementers to use Freescale Semiconductor products. There are no express or implied copyright licenses granted hereunder to design or fabricate any integrated circuits or integrated circuits based on the information in this document.

Freescale Semiconductor reserves the right to make changes without further notice to any products herein. Freescale Semiconductor makes no warranty, representation or guarantee regarding the suitability of its products for any particular purpose, nor does Freescale Semiconductor assume any liability arising out of the application or use of any product or circuit, and specifically disclaims any and all liability, including without limitation consequential or incidental damages. "Typical" parameters that may be provided in Freescale Semiconductor data sheets and/or specifications can and do vary in different applications and actual performance may vary over time. All operating parameters, including "Typicals", must be validated for each customer application by customer's technical experts. Freescale Semiconductor does not convey any license under its patent rights nor the rights of others. Freescale Semiconductor products are not designed, intended, or authorized for use as components in systems intended for surgical implant into the body, or other applications intended to support or sustain life, or for any other application in which the failure of the Freescale Semiconductor product could create a situation where personal injury or death may occur. Should Buyer purchase or use Freescale Semiconductor products for any such unintended or unauthorized application, Buyer shall indemnify and hold Freescale Semiconductor and its officers, employees, subsidiaries, affiliates, and distributors harmless against all claims, costs, damages, and expenses, and reasonable attorney fees arising out of, directly or indirectly, any claim of personal injury or death associated with such unintended or unauthorized use, even if such claim alleges that Freescale Semiconductor was negligent regarding the design or manufacture of the part.

Freescale™ and the Freescale logo are trademarks of Freescale Semiconductor, Inc. All other product or service names are the property of their respective owners.

© Freescale Semiconductor, Inc. 2007. All rights reserved.

Looking for pricing, stock, or lifecycle information?

Click below to explore more details on WIN SOURCE:

- ⊖ [View MRFE6S9205HSR3 on WIN SOURCE](#)
- ⊖ [Freescale Semiconductor - NXP Information](#)

Optimize Your Supply Chain with WIN SOURCE Solutions

- ✓ Global Sourcing Solution
- ✓ Obsolete Management
- ✓ Cost Control Management
- ✓ Shortage Management
- ✓ Alternative Solution
- ✓ Excess Inventory Management