



**THE DATASHEET OF
MSA-2011-TR1**



MSA-2011, MSA-2086

Silicon Bipolar RFIC Amplifiers



Data Sheet

Description

The MSA-2011 and MSA-2086 are high performance silicon bipolar RFIC amplifiers designed to be cascadable in 50Ω systems. The stability factor of $K > 1$ contributes to easy cascading in numerous narrow and broadband IF and RF commercial and industrial applications.

The MSA-2011 and -2086 are fabricated using a 10 GHz f_T , 25 GHz F_{MAX} , silicon bipolar RFIC process which utilizes nitride self-alignment, ion implantation, and gold metallization to achieve excellent uniformity, performance, and reliability. The use of an external bias resistor for temperature and current stability also allows bias flexibility.

Package options include the industry standard plastic surface mount SOT-143 package and the 85 mil surface mountable plastic microstripline package.

Features

MSA-2011

- Surface Mount SOT-143 Package
- 3 dB Bandwidth: DC to 1.0 GHz
- 16.2 dB Gain at 1 GHz
- 4.3 dB NF at 1 GHz
- Lead-free Option Available

MSA-2086

- Surface Mount Plastic Microstrip Package
- 3 dB Bandwidth: DC to 1.1 GHz
- 16.6 dB Gain at 1 GHz
- 3.7 dB NF at 1 GHz
- Lead-free Option Available

MSA-2011

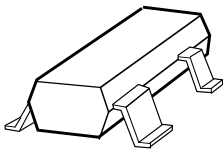

MSA-2086

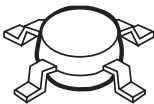

Pin Connections and Package Marking

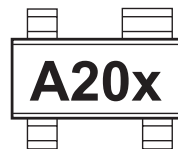

Notes:

Top View. Package Marking provides orientation and identification. "x" is the date code.

Absolute Maximum Ratings^[1]

Parameter	MSA-2011	MSA-2086
Device Current	50 mA	60 mA
Power Dissipation ^[2,3]	250 mW ^[3a]	325 mW ^[3c]
RF Input Power	+13 dBm	+13 dBm
Junction Temperature	150°C	150°C
Storage Temperature	-65 to 150°C	-65 to 150°C
Thermal Resistance: θ_{jc}	500°C/W	115°C/W

Notes:

1. Permanent damage may occur if any of these limits are exceeded.
2. $T_{CASE} = 25^{\circ}\text{C}$.
- 3a. Derate at 2.0 mW/°C for $T_C > 25^{\circ}\text{C}$.
- b. Derate at 6.5 mW/°C for $T_C > 149^{\circ}\text{C}$.
- c. Derate at 8.7 mW/°C for $T_C > 112^{\circ}\text{C}$.

Typical Biasing Configuration

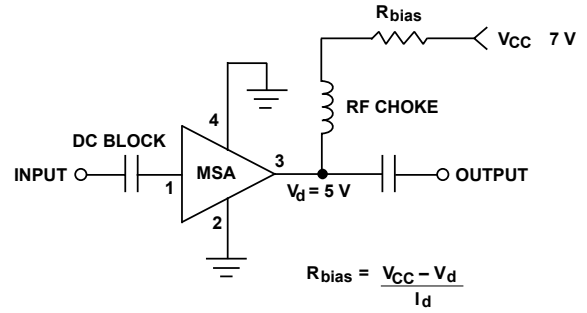

Electrical Specifications, $T_A = 25^{\circ}\text{C}$

$I_D = 32 \text{ mA}$, $Z_0 = 50 \Omega$

Symbol	Parameters and Test Conditions	Units	MSA-2011			MSA-2086		
			Min.	Typ.	Max.	Min.	Typ.	Max.
G_p	Power Gain ($ S_{21} ^2$) f = 0.1 GHz f = 0.5 GHz f = 1.0 GHz	dB	15.0	18.9 18.1 16.2		15.0	19.2 18.3 16.6	
ΔG_p	Gain Flatness f = 0.1 to 0.6 GHz	dB		± 0.6			± 0.6	
f_{3dB}	3 dB Bandwidth	GHz		1.0			1.1	
VSWR	Input VSWR f = 0.1 to 3.0 GHz			1.3:1			1.2:1	
	Output VSWR f = 0.1 to 3.0 GHz			1.4:1			1.5:1	
P_{1dB}	Power Output @ 1 dB Gain Compression: f = 1.0 GHz	dBm		9.0			9.0	
NF	50 Ω Noise Figure f = 1.0 GHz	dB		4.3			3.7	
IP_3	Third Order Intercept Point f = 1.0 GHz	dBm		22			22	
t_d	Group Delay f = 1.0 GHz	psec		143			143	
V_D	Device Voltage $T_C = 25^{\circ}\text{C}$	V	4.0	5.0	6.0	4.5	5.0	6.3
dV/dT	Device Voltage Temperature Coefficient	mV/°C		-9.3			-9.3	

Typical Performance for MSA-2011

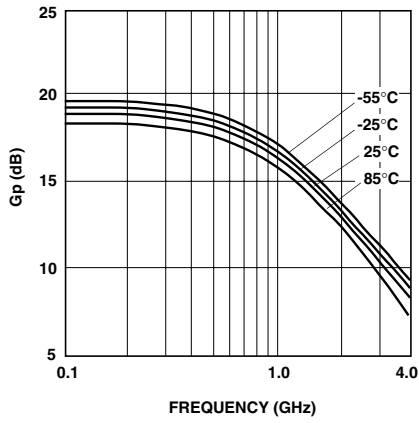

Figure 1. Power Gain vs. Frequency at Four Temperatures, $I_D = 32$ mA.

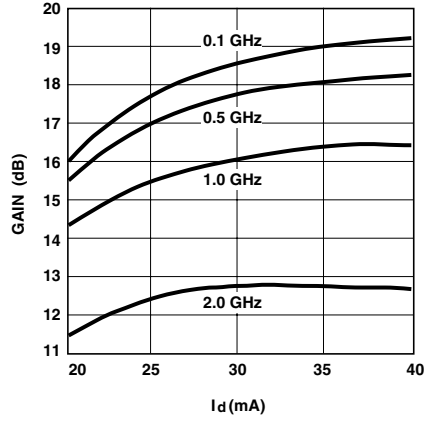

Figure 2. Power Gain vs. Current at 25°C.

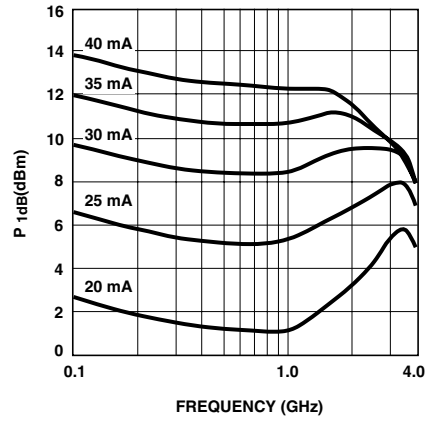

Figure 3. Typical P_{1dB} vs. Frequency at 25°C.

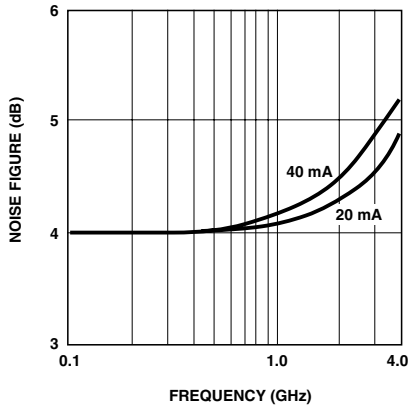

Figure 4. Noise Figure vs. Frequency at $I_D = 32$ mA.

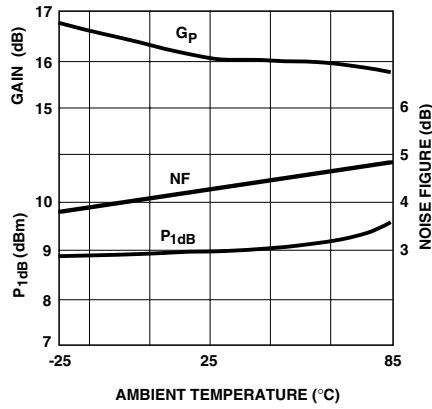

Figure 5. Power Gain, Noise Figure, and P_{1dB} vs. Temperature at 1 GHz and $I_D = 32$ mA.

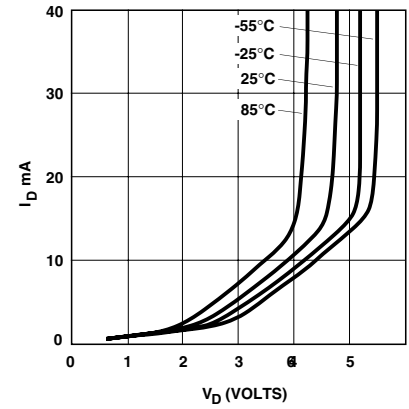

Figure 6. I_D vs. V_D at Four Temperatures.

Typical Scattering Parameters at $T_A = 25^\circ\text{C}$, for MSA-2011

$I_D = 32\text{ mA}$, $Z_o = 50\ \Omega$

Frequency (GHz)	S_{11}		S_{21}			S_{12}			S_{22}	
	Mag.	Ang.	(dB)	Mag.	Ang.	(dB)	Mag.	Ang.	Mag.	Ang.
0.1	0.05	7	18.9	8.81	172	-22.6	0.074	4	0.17	-13
0.2	0.05	9	18.8	8.73	165	-22.4	0.076	8	0.17	-23
0.3	0.06	3	18.6	8.52	157	-22.2	0.077	11	0.17	-34
0.4	0.06	1	18.3	8.25	150	-22.0	0.079	15	0.17	-43
0.5	0.06	0	18.1	8.00	143	-21.7	0.082	17	0.17	-52
0.6	0.07	-5	17.7	7.65	137	-21.4	0.085	20	0.17	-61
0.7	0.07	-8	17.3	7.33	131	-21.1	0.088	22	0.17	-68
0.8	0.08	-12	16.9	7.02	125	-20.7	0.092	24	0.17	-74
0.9	0.08	-18	16.3	6.70	120	-20.3	0.096	26	0.18	-80
1.0	0.08	-22	16.2	6.43	115	-20.0	0.100	28	0.18	-85
1.5	0.09	-46	14.3	5.16	93	-18.2	0.123	31	0.18	-102
2.0	0.11	-69	12.6	4.26	75	-16.7	0.146	31	0.17	-109
2.5	0.11	-93	11.2	3.64	59	-15.6	0.167	29	0.17	-111
3.0	0.12	-118	10.1	3.18	45	-14.7	0.185	26	0.18	-112
3.5	0.12	-152	9.1	2.85	31	-13.9	0.202	24	0.19	-116
4.0	0.15	174	8.1	2.55	18	-13.3	0.216	21	0.20	-124
4.5	0.22	147	7.4	2.33	5	-12.8	0.231	19	0.22	-133
5.0	0.30	127	6.5	2.11	-8	-12.2	0.246	17	0.25	-145
5.5	0.39	113	5.6	1.90	-20	-11.4	0.268	14	0.30	-157
6.0	0.45	100	4.5	1.68	-32	-10.7	0.292	10	0.35	-168

Ordering Information

Part Numbers	No. of Devices	Comments
MSA-2011-BLK	100	Bulk
MSA-2011-BLKG	100	Bulk
MSA-2011-TR1	3000	7" Reel
MSA-2011-TR1G	3000	7" Reel
MSA-2011-TR2	10000	13" Reel
MSA-2011-TR2G	10000	13" Reel

Note: Order part number with a "G" suffix if lead-free option is desired.

Typical Performance for MSA-2086

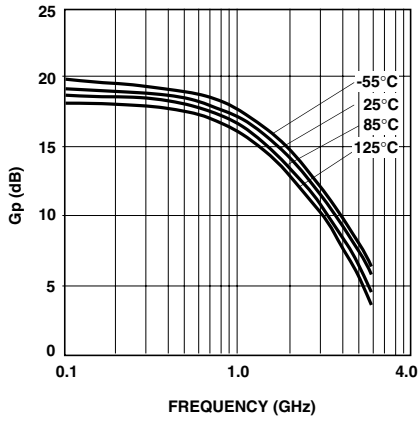

Figure 1. Power Gain vs. Frequency at Four Temperatures, $I_D = 32$ mA.

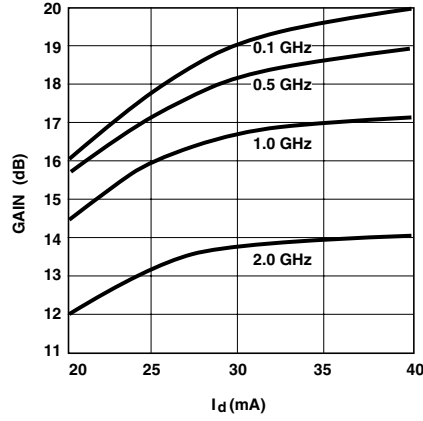

Figure 2. Power Gain vs. Current at 25°C.

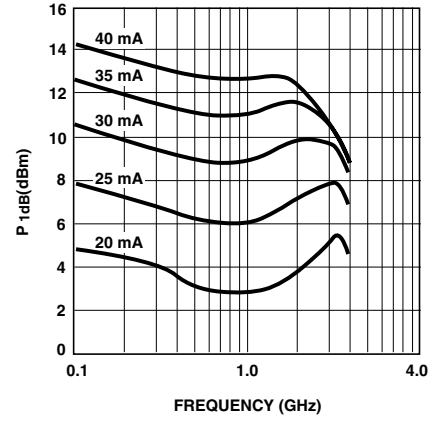

Figure 3. Typical P_{1dB} vs. Frequency at 25°C.

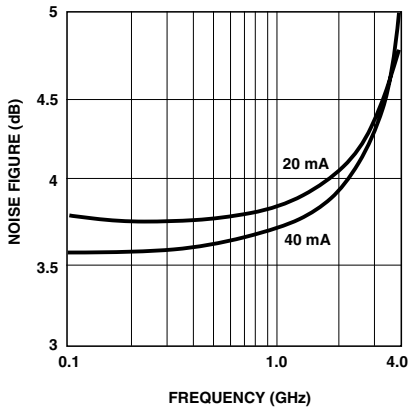

Figure 4. Noise Figure vs. Frequency at $I_D = 32$ mA.

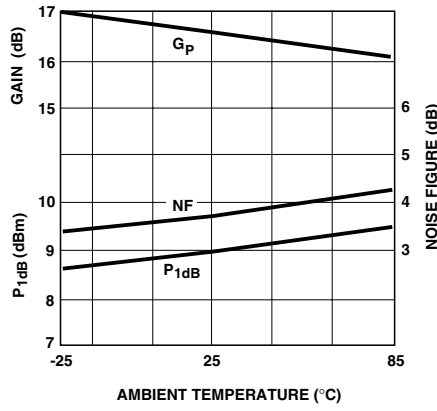

Figure 5. Power Gain, Noise Figure, and P_{1dB} vs. Temperature at 1 GHz and $I_D = 32$ mA.

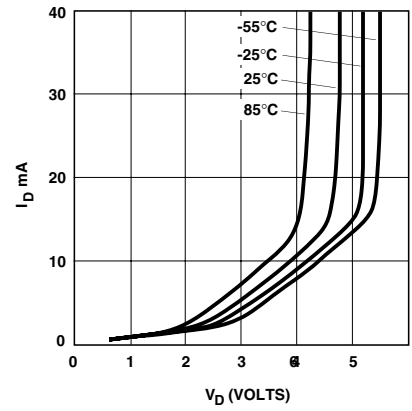

Figure 6. I_D vs. V_b at Four Temperatures.

Typical Scattering Parameters at $T_A = 25^\circ\text{C}$, for MSA-2086

$I_D = 32\text{ mA}$, $Z_o = 50\ \Omega$

Frequency (GHz)	S_{11}		S_{21}			S_{12}			S_{22}	
	Mag.	Ang.	(dB)	Mag.	Ang.	(dB)	Mag.	Ang.	Mag.	Ang.
0.1	0.06	1	19.2	9.08	172	-22.8	0.073	4	0.18	-15
0.2	0.05	-5	19.1	8.98	165	-22.6	0.074	7	0.17	-26
0.3	0.05	-10	18.9	8.80	157	-22.4	0.076	10	0.17	-37
0.4	0.07	-15	18.7	8.57	150	-22.2	0.078	13	0.19	-45
0.5	0.09	-18	18.4	8.29	143	-21.9	0.081	15	0.19	-53
0.6	0.09	-22	18.1	7.99	136	-21.6	0.084	18	0.20	-62
0.7	0.08	-23	17.7	7.66	130	-21.2	0.087	20	0.20	-71
0.8	0.08	-31	17.4	7.37	124	-20.8	0.091	21	0.20	-80
0.9	0.08	-34	17.0	7.07	118	-20.5	0.095	23	0.20	-87
1.0	0.08	-44	16.6	6.78	112	-20.1	0.099	23	0.19	-94
1.5	0.07	-71	14.8	5.49	88	-18.2	0.123	24	0.19	-125
2.0	0.06	-99	13.3	4.60	68	-16.7	0.146	22	0.17	-145
2.5	0.07	-176	11.9	3.93	50	-15.5	0.167	17	0.18	-174
3.0	0.14	151	10.7	3.42	31	-14.7	0.185	10	0.20	172
3.5	0.20	125	9.5	2.98	15	-14.2	0.196	3	0.24	153
4.0	0.29	106	8.3	2.61	-1	-13.8	0.204	-3	0.28	139
4.5	0.39	96	7.3	2.31	-15	-13.6	0.210	-8	0.32	129
5.0	0.51	90	6.3	2.08	-29	-13.3	0.217	-12	0.36	124
5.5	0.62	83	5.4	1.85	-43	-13.0	0.225	-16	0.40	119
6.0	0.69	75	4.3	1.64	-58	-12.7	0.233	-22	0.47	113

Ordering Information

Part Numbers	No. of Devices	Comments
MSA-2086-BLK	100	Bulk
MSA-2086-BLKG	100	Bulk
MSA-2086-TR1	1000	7" Reel
MSA-2086-TR1G	1000	7" Reel
MSA-2086-TR2	4000	13" Reel
MSA-2086-TR2G	4000	13" Reel

Note: Order part number with a "G" suffix if lead-free option is desired.

Outline Drawings

SOT-143

86

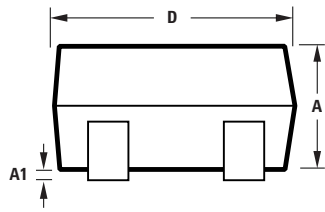
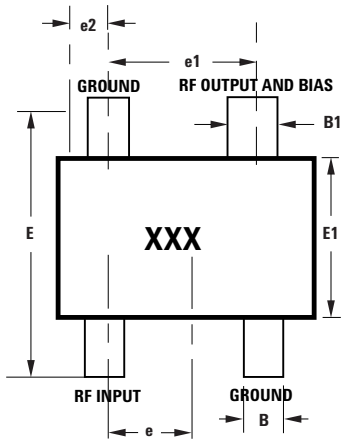

Notes:
 XXX-package marking
 Drawings are not to scale

SYMBOL	DIMENSIONS (mm)	
	MIN.	MAX.
A	0.79	1.097
A1	0.013	0.10
B	0.36	0.54
B1	0.76	0.92
C	0.086	0.152
D	2.80	3.06
E1	1.20	1.40
e	0.89	1.02
e1	1.78	2.04
e2	0.45	0.60
E	2.10	2.65
L	0.45	0.69

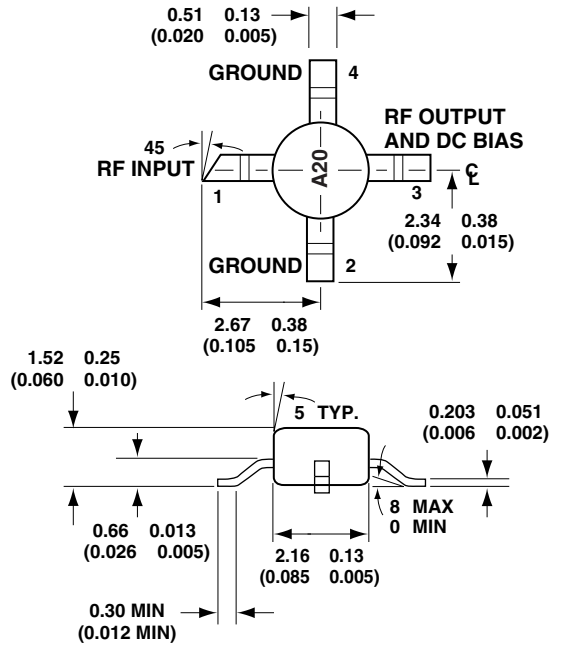
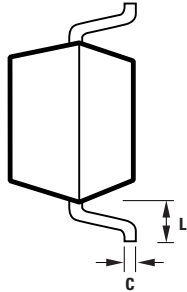

DIMENSIONS ARE IN MILLIMETERS (INCHES)

For product information and a complete list of distributors, please go to our web site: www.avagotech.com

Avago, Avago Technologies, and the A logo are trademarks of Avago Technologies, Limited in the United States and other countries. Data subject to change. Copyright © 2006 Avago Technologies, Limited. All rights reserved. Obsoletes 5989-4457EN AV02-0791EN - October 30, 2007



Looking for pricing, stock, or lifecycle information?

Click below to explore more details on WIN SOURCE:

 [View MSA-2011-TR1 on WIN SOURCE](#)

 [Broadcom Limited](#) Information

Optimize Your Supply Chain with WIN SOURCE Solutions

-  Global Sourcing Solution
-  Obsolete Management
-  Cost Control Management
-  Shortage Management
-  Alternative Solution
-  Excess Inventory Management