



**THE DATASHEET OF  
MSKD70-12**





## Glass Passivated Rectifier Diode Modules

**VRRM** 800 to 1800V  
**IFAV** 70 Amp

### Applications

- Non-controllable rectifiers for AC/AC converters
- Line rectifiers for transistorized AC motor controllers
- Field supply for DC motors

### Features

- Blocking voltage:800 to 1800V
- Heat transfer through aluminum oxide DBC ceramic isolated metal baseplate
- Glass passivated chip
- UL E243882 approved

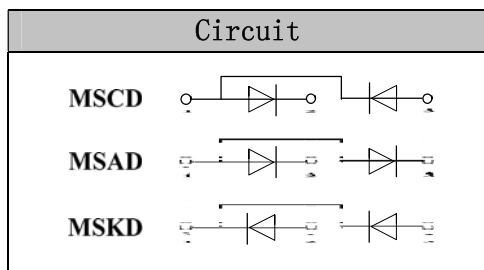

### Module Type

TYPE			VRRM	VRSM
MSCD70-08	MSAD70-08	MSKD70-08	800V	900V
MSCD70-12	MSAD70-12	MSKD70-12	1200V	1300V
MSCD70-16	MSAD70-16	MSKD70-16	1600V	1700V
MSCD70-18	MSAD70-18	MSKD70-18	1800V	1900V

### Maximum Ratings

Symbol	Conditions	Values	Units
IFAV	Single phase ,half wave 180° conduction Tc=102°C	70	A
IF(RMS)	Single phase ,half wave 180° conduction Tc=99°C	105	A
IFSM	t=10mS Tvj =45°C	1400	A
i <sup>2</sup> t	t=10mS Tvj =45°C	9800	A <sup>2</sup> s
Visol	a.c.50HZ;r.m.s.;1min	3000	V
Tvj		-40 to 150	°C
Tstg		-40 to 125	°C
Mt	To terminals(M5)	3±15%	Nm
Ms	To heatsink(M6)	5±15%	Nm
Weight	Module (Approximately)	100	g

### Thermal Characteristics

Symbol	Conditions	Values	Units
Rth(j-c)	Per diode	0.51	°C/W
Rth(c-s)	Module	0.1	°C/W

### Electrical Characteristics

Symbol	Conditions	Values			Units
		Min.	Typ.	Max.	
VFM	T=25°C IF =200A	—	1.20	1.48	V
IRD	Tvj=150°C VRD=VRRM	—	—	5	mA

## Performance Curves

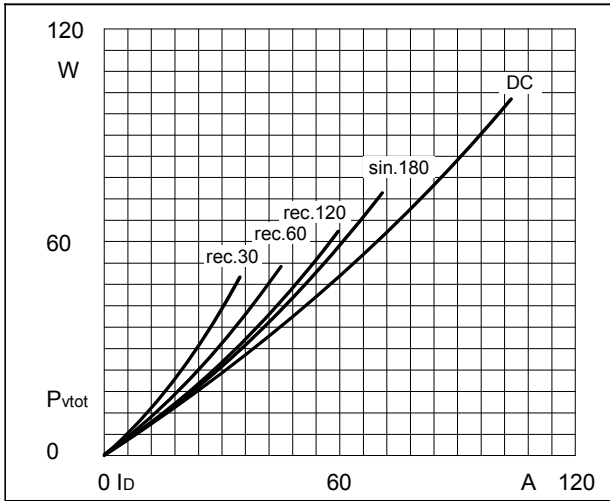

**Fig1. Power dissipation**

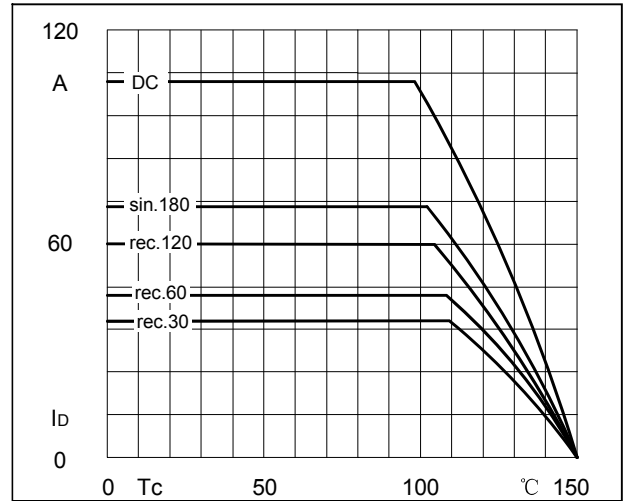

**Fig2. Forward Current Derating Curve**

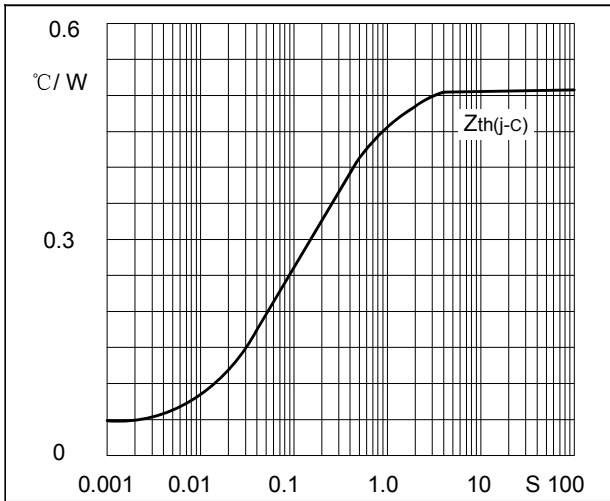

**Fig3. Transient thermal impedance**

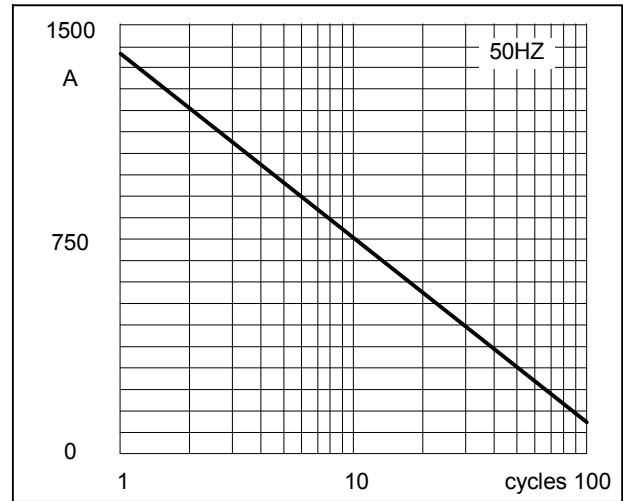

**Fig4. Max Non-Repetitive Forward Surge Current**

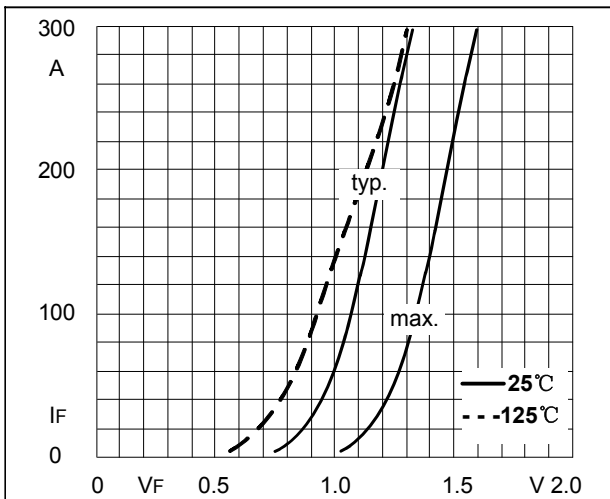

**Fig5. Forward Characteristics**

## Package Outline Information

CASE: D1

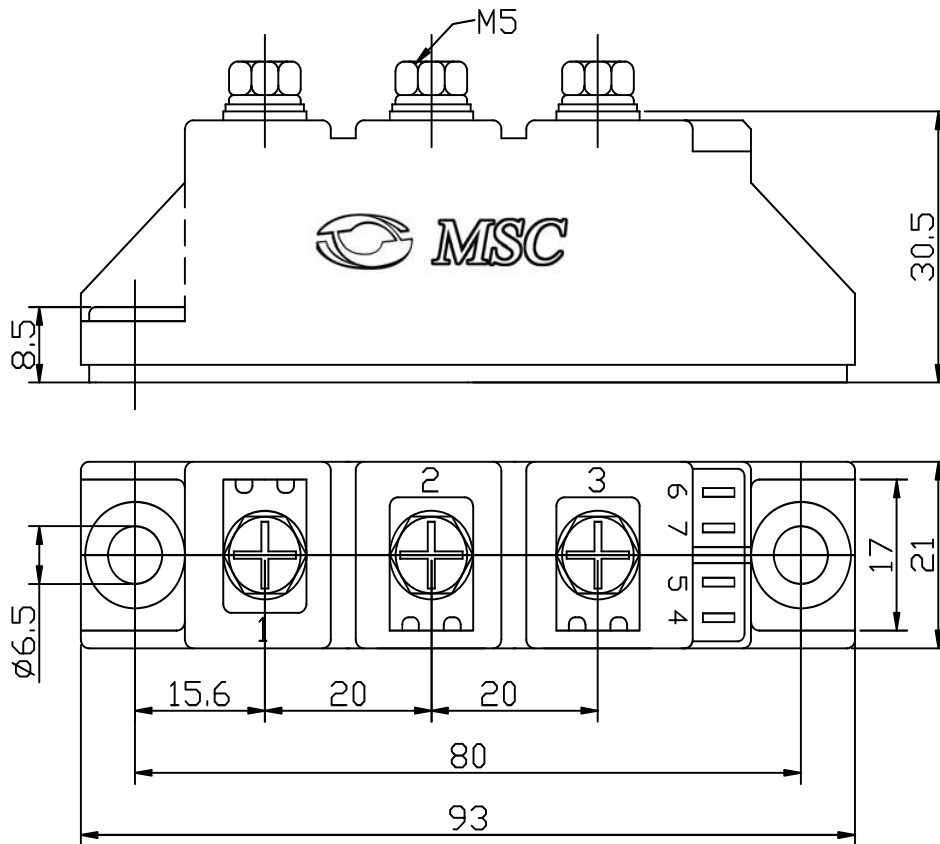

Dimensions in mm

## Looking for pricing, stock, or lifecycle information?

Click below to explore more details on WIN SOURCE:

- ⊖ [View MSKD70-12 on WIN SOURCE](#)
- ⊖ [Microsemi Corporation Information](#)

## Optimize Your Supply Chain with WIN SOURCE Solutions

- ✓ Global Sourcing Solution
- ✓ Obsolete Management
- ✓ Cost Control Management
- ✓ Shortage Management
- ✓ Alternative Solution
- ✓ Excess Inventory Management