



**THE DATASHEET OF
N.FL-R-SMT-1(10)**



Lightweight SMT Miniature Coaxial Connectors – 1.4 mm Mated Height

N.FL Series

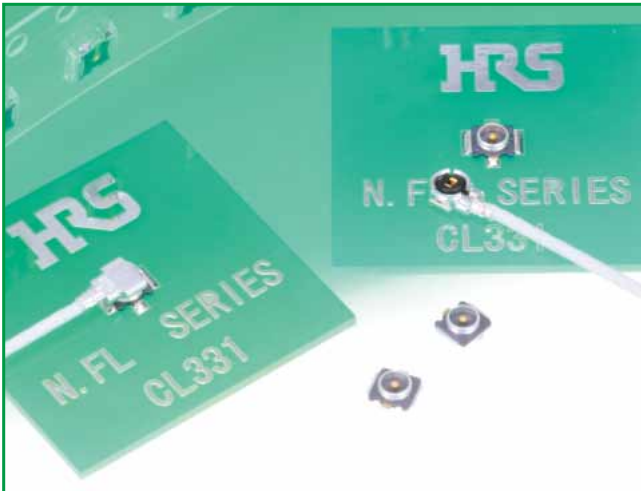

● Mated height comparison (With U.FL-LP(V))

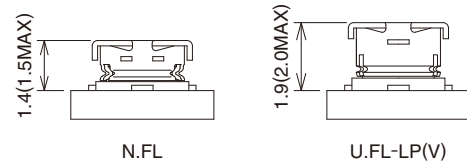

Fig.1

■ Features

1. Low profile

Nominal mated height is 1.4 mm (Max. 1.5 mm)

2. Small size: 7.7 mm²

3. Light weight

Receptacle : 14 mg
Plug : 28 mg

4. Accepts high frequency transmission of DC to 6 GHz.

V.S.W.R. = 1.3 max. (DC to 6 GHz)

5. Board placement with automatic equipment

Receptacles are packaged in embossed carrier tape and reel for automatic mounting.

6. Plugs are terminated with ultra-fine coaxial (fluorinated resin insulated) cable.

7. Special tool for an extraction

8. Verification of the fully mated condition

Tactile click sensation confirms fully mated condition, assuring complete electrical and mechanical connection.

9. Halogen-free*(Receptacle, plug(HF type))

*As defined by IEC61249-2-21

Br-900 ppm maximum, Cl-900 ppm maximum,
Cl+Br combined - 1,500 ppm maximum

■ Applications

Mobile phones, wireless communication devices, electronic measuring instruments, GPS, wireless LAN, Bluetooth and any application requiring high frequency transmission using small coaxial connectors.

● N.FL Plug and Receptacle

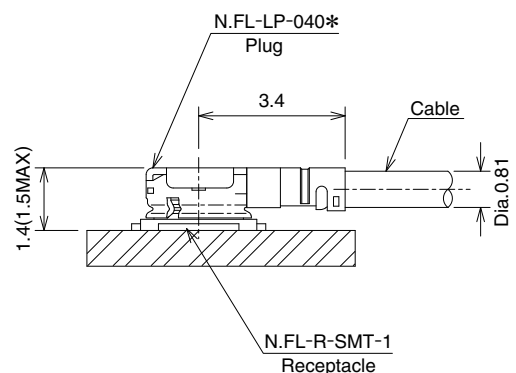

Fig.2

Specifications

Ratings	Nominal characteristic impedance	50 ohms	Operating temperature range	-40°C to +90°C (90% RH max.)
	Frequency range	DC to 6 GHz	Storage temperature range	-30°C to +70°C (90% RH max.)

Item	Specification	Conditions
1. Contact resistance	Center contact: 25 m ohms max. Outer contact: 25 m ohms max.	10 mA max.
2. Insulation resistance	500 M ohms min.	100V DC
3. Withstanding voltage	No flashover or insulation breakdown	200V AC / 1 minute
4. V.S.W.R.(Note)	1.3max.	DC to 6GHz
5. Durability	Contact resistance Center contact: 30 m ohms max. Outer contact: 30 m ohms max. No damage, cracks, or parts dislocation	20 cycles
6. Vibration	No electrical discontinuity of 1 μs or longer No damage, cracks, or parts dislocation	Frequency: 10 to 100 Hz, single amplitude of 1.5 mm Acceleration: 59 m/s ² , in each of 3 axis 5 cycles
7. Shock	No electrical discontinuity of 1 μs or longer No damage, cracks, or parts dislocation	Acceleration of 735 m/s ² , 11 ms continuous time Waveform: sine half-wave, 3 cycles in each of the 3 axis
8. Humidity	Insulation resistance: 100 M ohms min. (high humidity) Insulation resistance: 500 M ohms min. (dry) No damage, cracks, or parts dislocation	96 hours at +40°C, and humidity of 95%
9. Temperature cycle	No damage, cracks, or parts dislocation	Temperature:-40°C→+5°C to +35°C→+90°C→+5°C to +35°C Time: 30 min.→ 5 min. max. → 30 min. → 5 min. max. 5 cycles
10. Salt spray test	No excessive corrosion	5% salt water solution, 48 hours

Note: Information contained in this catalog represents general requirements for this Series. Contact us for the drawings and specifications for a specific part number shown.

* V.S.W.R. Measurement System
Measured as shown on the block diagram below.

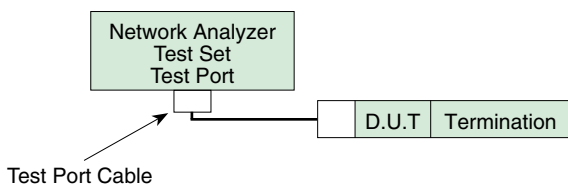

Note1: N.FL Cable assembly (plug) is measured with SMA conversion adapters mated with N.FL plugs at both ends of a 100cm coaxial cable harness

Note2: N.FL receptacle, which is mounted on a 50 ohms glass epoxy board, is measured with a SMA conversion adapter.

Materials / Finishes

Plugs-Right Angle

Part	Material	Finish
Shell	Phosphor bronze	Silver plated
Female center contact	Phosphor bronze	Gold plated
Insulator	PBT	Color: Black, UL94V-0
		Color: Gray, UL94HB(HF type)

Receptacle

Part	Material	Finish
Shell	Phosphor bronze	Silver plated
Male center contact	Brass	Gold plated
Insulator	LCP	Color: Black, UL94V-0

■ Cable Assembly(Plug)

N.FL-LP-040(06), N.FL-LP-040HF(06)(Applicable cable: outer diameter 0.81)

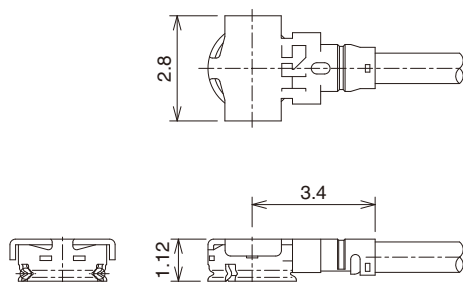

Ordering Information

[Plugs can be ordered only as terminated cable assemblies]

◆ How To Specify Cable Assembly

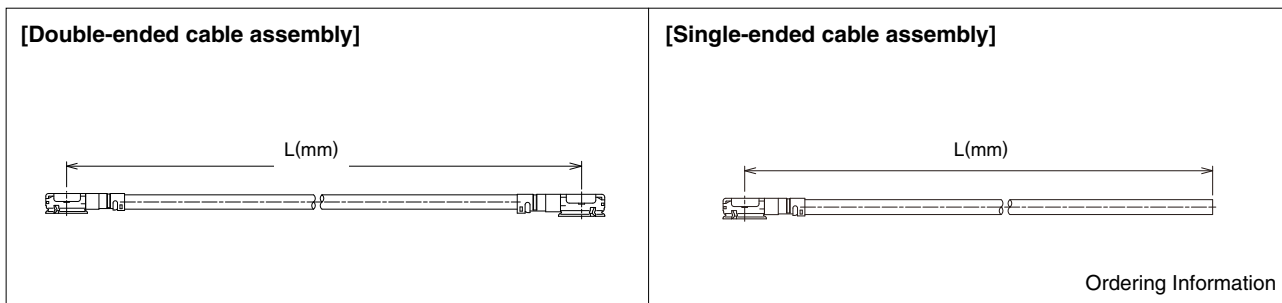

● Ordering Information

Used Plug: N.FL-LP-040(06), N.FL-LP-040HF(06)

Double-Ended **N.FL - 2LP HF6 - 04N [] TV-A - L**
 ① ② ③ ④ ⑤ ⑥ ⑦

Single-Ended **N.FL - LP HF6 - 04N [] TV-A - L**
 ① ② ③ ④ ⑤ ⑥ ⑦

① Series name	N.FL
② Assembly type	LP : Single ended 2LP : Double ended
③ Environmental compliant	HF6 : Halogen-free plug 6 : Standard Plug
④ Cable type	04N : 0.81mm dia. ultra-time coaxial cable
⑤ Cable color	1:White 2:Black
⑥ Cable outer conductor	TV: Tin plated braided wire
⑦ Total length (mm)	Length(L)

● Standard tolerances for (L)

(L)mm	Standard Tolerance(mm)
*L=35 to 200	±4
*L=200 to 500	±8
*L=500 to 1000	±12
L=Longer than 1000	±1.5% of (L)

Note: Minimum available length(L) is 35mm.

■ Receptacle

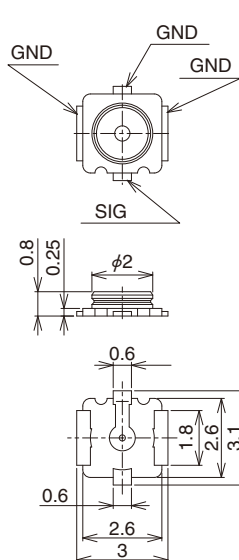
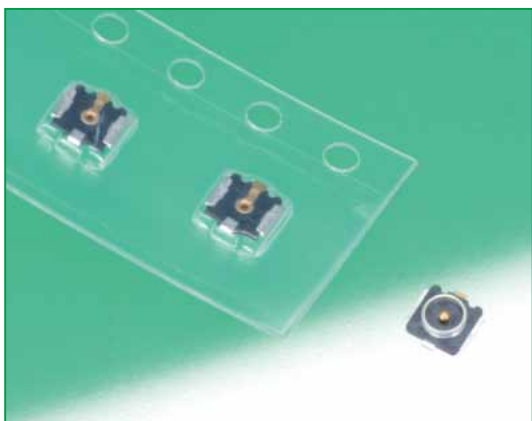

◆ Recommended PCB mounting pattern

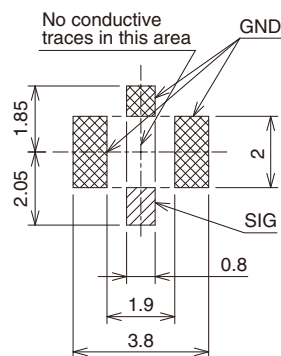

All dimensions: mm

Part No.	HRS No.	Packaging	RoHS
N.FL-R-SMT-1(60)	331-0332-3 60	Reel (5,000 pcs/reel)	○
N.FL-R-SMT-1(80)	331-0332-3 80	Reel (10,000 pcs/reel)	

● Embossed Carrier Tape Dimensions (IEC 60286-3 compliant)

Embossed Carrier tape Dimensions

(N.FL-R-SMT-1(60) 8mm pitch)

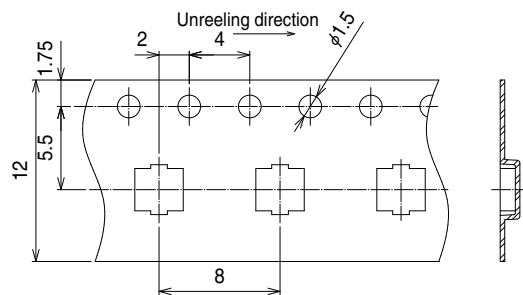

(N.FL-R-SMT-1(80) 4mm pitch)

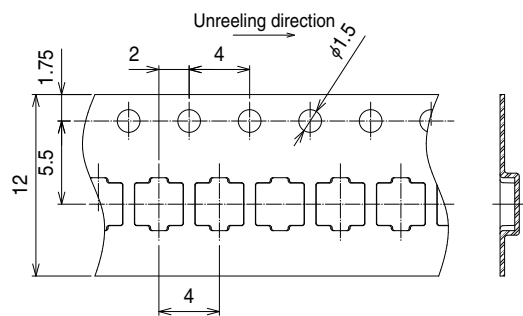

Reel Dimensions

Material : PS(Black)

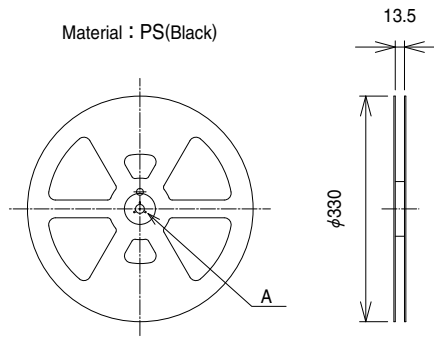

A (SCALE FREE)

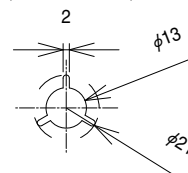

All dimensions: mm

■ Conversion Adapters

● SMA Conversion Adapter (N.FL / U.FL side jack - SMA side plug)



Note: The FL side mating portions has a lower lock retention force than the regular product, therefore, cannot be used for purposes other than performance measurements.

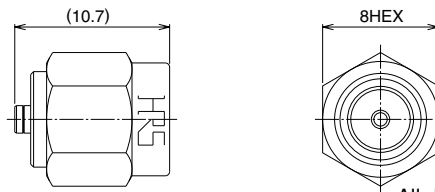

All dimensions: mm

Part No.	HRS No.	RoHS
HRMP-U.FLJ(40)	311-0300-2 40	○

Note: Applicable to both N.FL and U.FL.

● SMA Conversion Adapter (N.FL / U.FL side plug - SMA side jack)



Note: The FL side mating portions has a lower lock retention force than the regular product, therefore, cannot be used for purposes other than performance measurements.

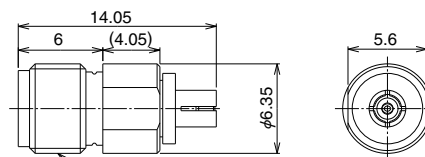

All dimensions: mm

Part No.	HRS No.	RoHS
HRMJ-U.FLP(40)	311-0301-5 40	○

Note: Applicable to both N.FL and U.FL.

● SMA Conversion Adapter



Note: When mating with corresponding part (N.FL-R-SMT-1) must be pressed down and held to make complete connection.

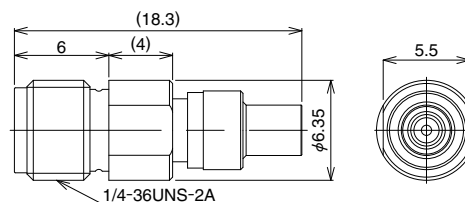

All dimensions: mm

Part No.	HRS No.	RoHS
HRMJ-N.FLP-ST5	311-0423-2	○

■ Receptacle Inspection Adapter

Used for inspecting the performance parameters of the cable assembly.

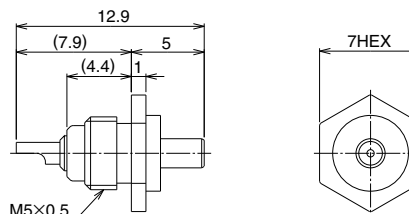
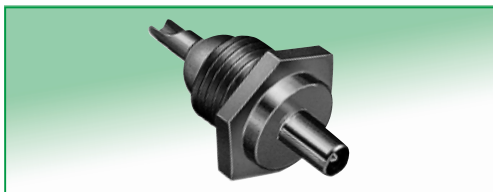

All dimensions: mm

Part No.	HRS No.	RoHS
U.FL-R-1	331-0466-0	○

Note: Applicable to both N.FL and U.FL.

◆ Plug mating tool

This tool is used for mating a plug.

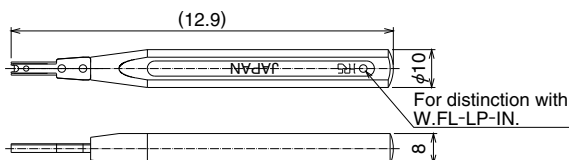

All dimensions: mm

Part No.	HRS No.	RoHS
U.FL-LP-IN	331-0334-9	○

◆ Plug extraction tool

This jig is used for extraction from a mating condition.

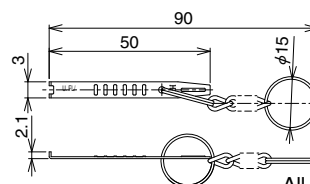

All dimensions: mm

Part No.	HRS No.	RoHS
U.FL-LP(V)-N-2	331-0493-2	○

Note: Applicable to all the U.FL-LP(V)-040, U.FL-LP-062 and N.FL.

Usage Precautions

1. Plug

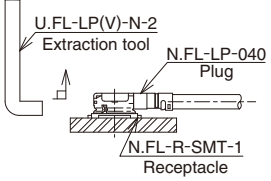
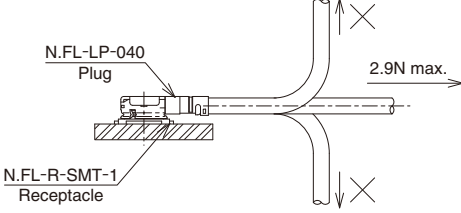
(1) Mating / unmating	<ul style="list-style-type: none"> • Unmating Insert the end of an extraction tool into a space between a plug and receptacle, and pull up the tool in the perpendicular to a mounting surface of a receptacle, as shown in the figure. <ul style="list-style-type: none"> ● Recommended the use of the extraction tool for unmating. Any attempt of unmating by pulling on the cable may result in damage to the mechanical / electrical performance. • Mating Do not attempt to insert on an extreme angle. 
(2) Pull forces on the cable after connectors are mated	<p>Do not apply any pull forces after the bending of the cable.</p> 
(3) Precautions	Do not twist connectors excessively during mating / unmating.

2. Receptacle

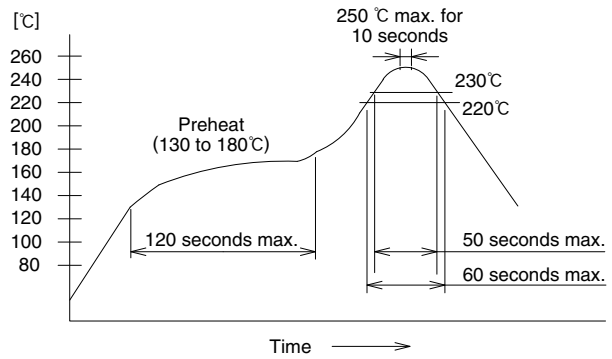
(1) Recommended reflow temperature profile	 <p>① The temperature profile indicates the board surface temperature at the point of contacts with the connector leads.</p> <p>② In individual applications the actual temperature may vary, depending on the solder paste type, volume / thickness and board size / thickness. Consult your solder paste and equipment manufacturer for the detailed recommendations.</p>
(2) Manual soldering	Soldering iron temperature: 350°C, Soldering time: for 5 seconds max.
(3) Recommended metal mask thickness	0.1 mm to 0.12 mm
(4) Reflow cycles	2 times

3. Operating environment and storage conditions

(1) Operating environment	<p>The connectors are not designed to operate in the following environments:</p> <ul style="list-style-type: none"> • Exposed to a excessive amounts of fine particles and dust • Regions and places having a high density of sulfur dioxide, hydrogen sulfide, nitrogen dioxide or other corrosive gasses. • Environments having large rapid variations in temperature.
(2) Storage conditions - Receptacle	<p>Store in the Hirose Electric packaging.</p> <p>Temperature: -10 to +40°C, Humidity: 85% max.</p> <p>Use within 6 months of delivery.</p> <p>Receptacles for which the storage period has elapsed must be tested for solderability to the PC board mounting surface.</p>



HIROSE ELECTRIC CO.,LTD.

2-6-3,Nakagawa Chuoh,Tsuzuki-Ku,Yokohama-Shi 224-8540,JAPAN

TEL: +81-45-620-3526 Fax: +81-45-591-3726

<http://www.hirose.com>

<http://www.hirose-connectors.com>

Looking for pricing, stock, or lifecycle information?

Click below to explore more details on WIN SOURCE:

-  [View N.FL-R-SMT-1\(10\) on WIN SOURCE](#)
-  [Hirose Electric Co Ltd Information](#)

Optimize Your Supply Chain with WIN SOURCE Solutions

-  Global Sourcing Solution
-  Obsolete Management
-  Cost Control Management
-  Shortage Management
-  Alternative Solution
-  Excess Inventory Management