



**THE DATASHEET OF  
N.FL-R-SMT-1(80)**



# Lightweight SMT Miniature Coaxial Connectors – 1.4 mm Mated Height

## N.FL Series

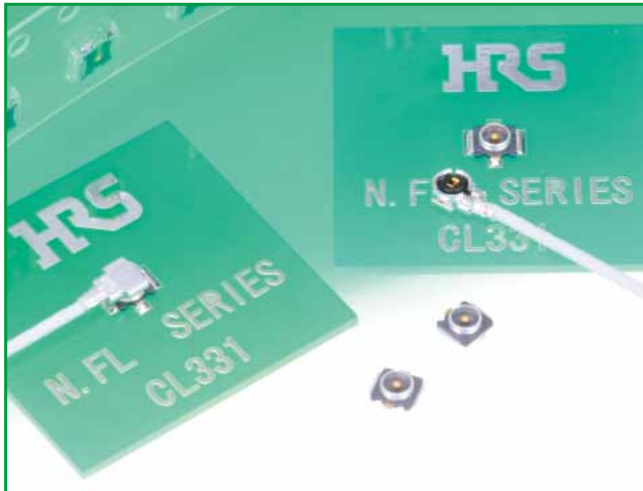

### ●Mated height comparison (With U.FL-LP(V) )

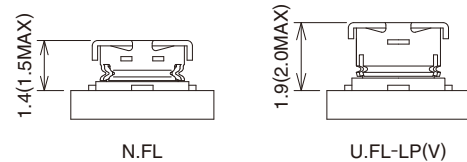

Fig.1

### ■Features

#### 1. Low profile

Nominal mated height is 1.4 mm (Max. 1.5 mm)

#### 2. Small size: 7.7 mm<sup>2</sup>

#### 3. Light weight

Receptacle : 14 mg  
Plug : 28 mg

#### 4. Accepts high frequency transmission of DC to 6 GHz.

V.S.W.R. = 1.3 max. (DC to 6 GHz)

#### 5. Board placement with automatic equipment

Receptacles are packaged in embossed carrier tape and reel for automatic mounting.

#### 6. Plugs are terminated with ultra-fine coaxial (fluorinated resin insulated) cable.

#### 7. Special tool for an extraction

#### 8. Verification of the fully mated condition

Tactile click sensation confirms fully mated condition, assuring complete electrical and mechanical connection.

#### 9. Halogen-free\*(Receptacle, plug(HF type))

\*As defined by IEC61249-2-21

Br-900 ppm maximum, Cl-900 ppm maximum,  
Cl+Br combined - 1,500 ppm maximum

### ■Applications

Mobile phones, wireless communication devices, electronic measuring instruments, GPS, wireless LAN, Bluetooth and any application requiring high frequency transmission using small coaxial connectors.

### ●N.FL Plug and Receptacle

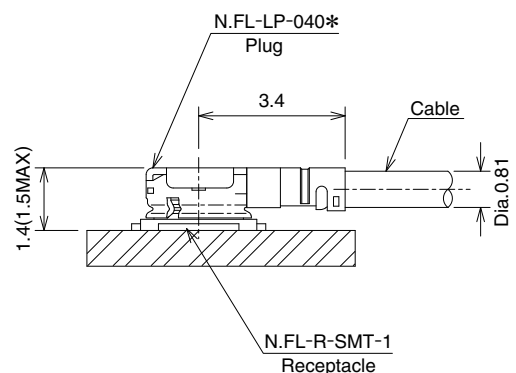

Fig.2

## ■ Specifications

Ratings	Nominal characteristic impedance	50 ohms	Operating temperature range	-40°C to +90°C (90% RH max.)
	Frequency range	DC to 6 GHz	Storage temperature range	-30°C to +70°C (90% RH max.)

Item	Specification	Conditions
1. Contact resistance	Center contact: 25 m ohms max. Outer contact: 25 m ohms max.	10 mA max.
2. Insulation resistance	500 M ohms min.	100V DC
3. Withstanding voltage	No flashover or insulation breakdown	200V AC / 1 minute
4. V.S.W.R.(Note)	1.3max.	DC to 6GHz
5. Durability	Contact resistance Center contact: 30 m ohms max. Outer contact: 30 m ohms max. No damage, cracks, or parts dislocation	20 cycles
6. Vibration	No electrical discontinuity of 1 μs or longer No damage, cracks, or parts dislocation	Frequency: 10 to 100 Hz, single amplitude of 1.5 mm Acceleration: 59 m/s <sup>2</sup> , in each of 3 axis 5 cycles
7. Shock	No electrical discontinuity of 1 μs or longer No damage, cracks, or parts dislocation	Acceleration of 735 m/s <sup>2</sup> , 11 ms continuous time Waveform: sine half-wave, 3 cycles in each of the 3 axis
8. Humidity	Insulation resistance: 100 M ohms min. (high humidity) Insulation resistance: 500 M ohms min. (dry) No damage, cracks, or parts dislocation	96 hours at +40°C, and humidity of 95%
9. Temperature cycle	No damage, cracks, or parts dislocation	Temperature:-40°C→+5°C to +35°C→+90°C→+5°C to +35°C Time: 30 min.→ 5 min. max. → 30 min. → 5 min. max. 5 cycles
10. Salt spray test	No excessive corrosion	5% salt water solution, 48 hours

Note: Information contained in this catalog represents general requirements for this Series. Contact us for the drawings and specifications for a specific part number shown.

\* V.S.W.R. Measurement System  
Measured as shown on the block diagram below.

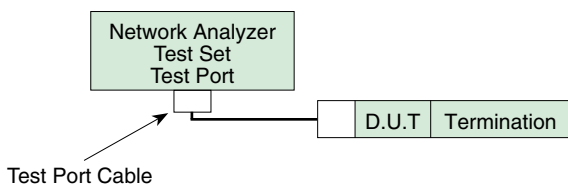

Note1: N.FL Cable assembly (plug) is measured with SMA conversion adapters mated with N.FL plugs at both ends of a 100cm coaxial cable harness

Note2: N.FL receptacle, which is mounted on a 50 ohms glass epoxy board, is measured with a SMA conversion adapter.

## ■ Materials / Finishes

### ● Plugs-Right Angle

Part	Material	Finish
Shell	Phosphor bronze	Silver plated
Female center contact	Phosphor bronze	Gold plated
Insulator	PBT	Color: Black, UL94V-0
		Color: Gray, UL94HB(HF type)

### ● Receptacle

Part	Material	Finish
Shell	Phosphor bronze	Silver plated
Male center contact	Brass	Gold plated
Insulator	LCP	Color: Black, UL94V-0

## ■ Cable Assembly(Plug)

N.FL-LP-040(06), N.FL-LP-040HF(06)(Applicable cable: outer diameter 0.81)

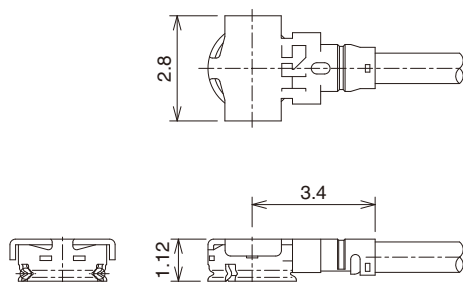

Ordering Information

[Plugs can be ordered only as terminated cable assemblies]

## ◆ How To Specify Cable Assembly

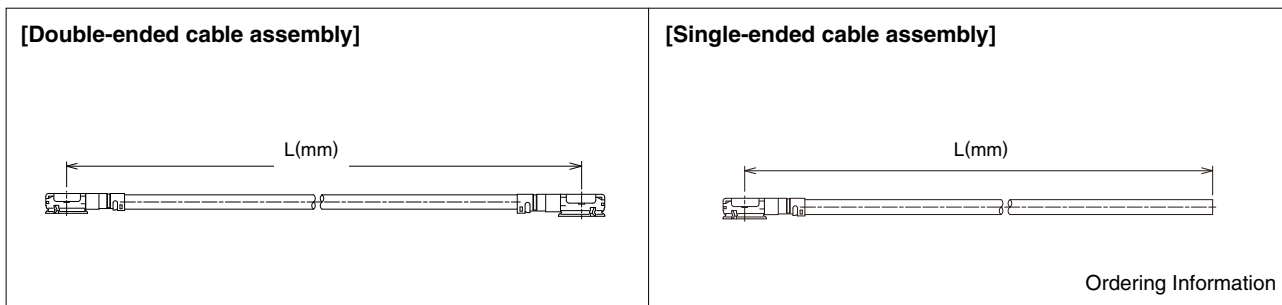

### ● Ordering Information

Used Plug: N.FL-LP-040(06), N.FL-LP-040HF(06)

Double-Ended **N.FL - 2LP HF6 - 04N [ ] TV-A - L**  
 ① ② ③ ④ ⑤ ⑥ ⑦

Single-Ended **N.FL - LP HF6 - 04N [ ] TV-A - L**  
 ① ② ③ ④ ⑤ ⑥ ⑦

① Series name	N.FL
② Assembly type	LP : Single ended 2LP : Double ended
③ Environmental compliant	HF6 : Halogen-free plug 6 : Standard Plug
④ Cable type	04N : 0.81mm dia. ultra-time coaxial cable
⑤ Cable color	1:White 2:Black
⑥ Cable outer conductor	TV: Tin plated braided wire
⑦ Total length (mm)	Length(L)

### ● Standard tolerances for (L)

(L)mm	Standard Tolerance(mm)
*L=35 to 200	±4
*L=200 to 500	±8
*L=500 to 1000	±12
L=Longer than 1000	±1.5% of (L)

Note: Minimum available length(L) is 35mm.

## ■ Receptacle

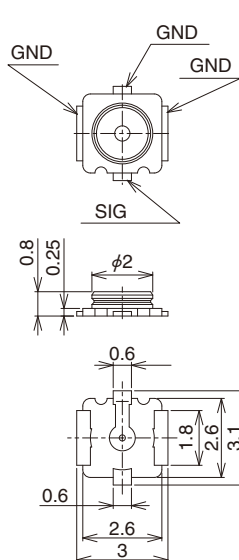
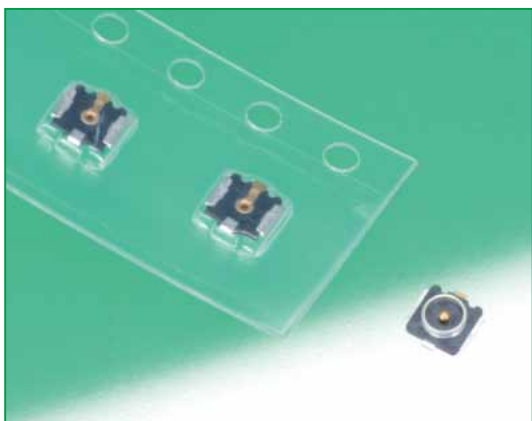

## ◆ Recommended PCB mounting pattern

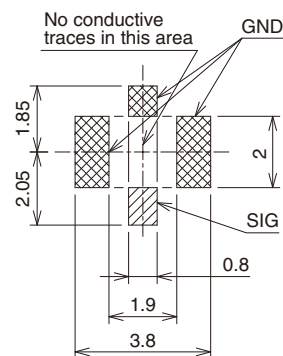

All dimensions: mm

Part No.	HRS No.	Packaging	RoHS
N.FL-R-SMT-1(60)	331-0332-3 60	Reel (5,000 pcs/reel)	○
N.FL-R-SMT-1(80)	331-0332-3 80	Reel (10,000 pcs/reel)	

## ● Embossed Carrier Tape Dimensions (IEC 60286-3 compliant)

### Embossed Carrier tape Dimensions

(N.FL-R-SMT-1(60) 8mm pitch)

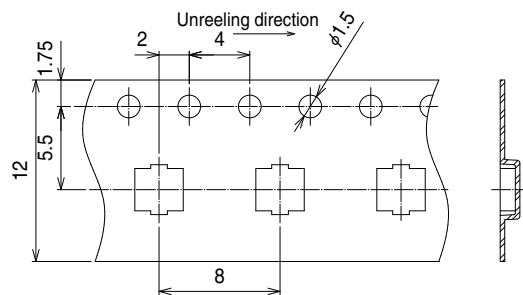

(N.FL-R-SMT-1(80) 4mm pitch)

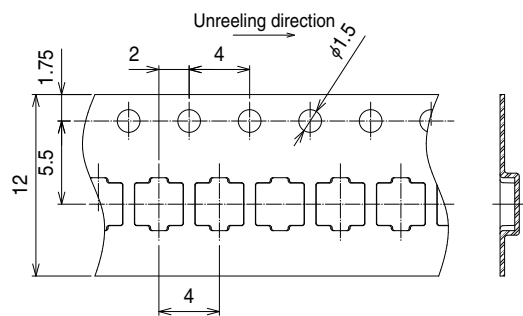

### Reel Dimensions

Material : PS(Black)

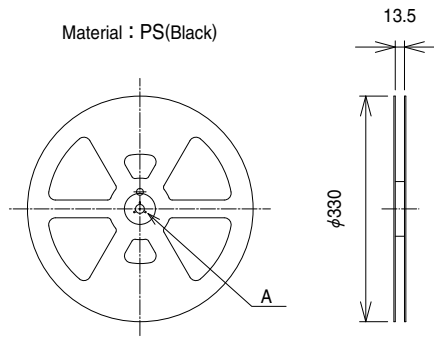

A (SCALE FREE)

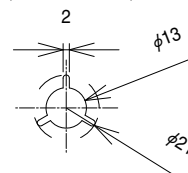

All dimensions: mm

## ■ Conversion Adapters

### ● SMA Conversion Adapter (N.FL / U.FL side jack - SMA side plug)



Note: The FL side mating portions has a lower lock retention force than the regular product, therefore, cannot be used for purposes other than performance measurements.

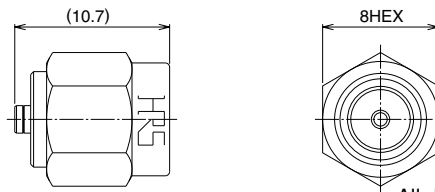

All dimensions: mm

Part No.	HRS No.	RoHS
HRMP-U.FLJ(40)	311-0300-2 40	○

Note: Applicable to both N.FL and U.FL.

### ● SMA Conversion Adapter (N.FL / U.FL side plug - SMA side jack)



Note: The FL side mating portions has a lower lock retention force than the regular product, therefore, cannot be used for purposes other than performance measurements.

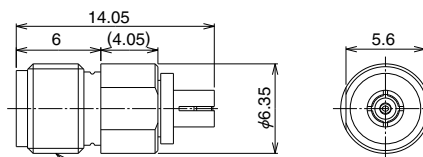

All dimensions: mm

Part No.	HRS No.	RoHS
HRMJ-U.FLP(40)	311-0301-5 40	○

Note: Applicable to both N.FL and U.FL.

### ● SMA Conversion Adapter



Note: When mating with corresponding part (N.FL-R-SMT-1) must be pressed down and held to make complete connection.

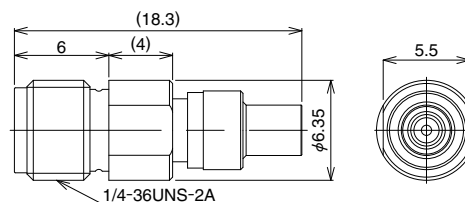

All dimensions: mm

Part No.	HRS No.	RoHS
HRMJ-N.FLP-ST5	311-0423-2	○

## ■ Receptacle Inspection Adapter

Used for inspecting the performance parameters of the cable assembly.

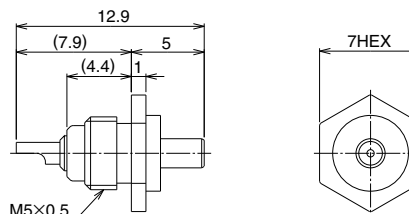
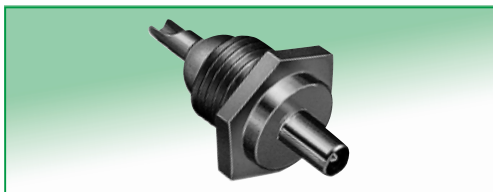

All dimensions: mm

Part No.	HRS No.	RoHS
U.FL-R-1	331-0466-0	○

Note: Applicable to both N.FL and U.FL.

## ◆ Plug mating tool

This tool is used for mating a plug.

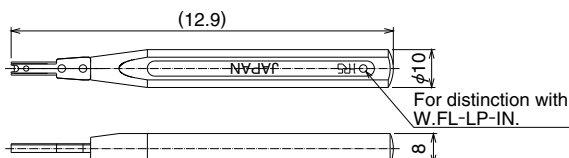

All dimensions: mm

Part No.	HRS No.	RoHS
U.FL-LP-IN	331-0334-9	○

## ◆ Plug extraction tool

This jig is used for extraction from a mating condition.

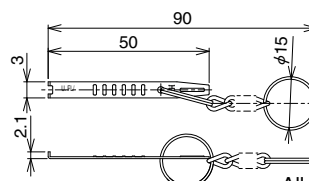

All dimensions: mm

Part No.	HRS No.	RoHS
U.FL-LP(V)-N-2	331-0493-2	○

Note: Applicable to all the U.FL-LP(V)-040, U.FL-LP-062 and N.FL.

## Usage Precautions

### 1. Plug

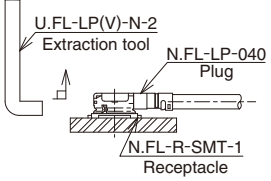
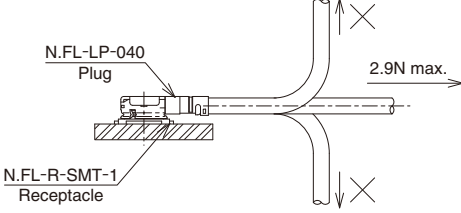
(1) Mating / unmating	<ul style="list-style-type: none"> <li>• <b>Unmating</b> Insert the end of an extraction tool into a space between a plug and receptacle, and pull up the tool in the perpendicular to a mounting surface of a receptacle, as shown in the figure.                     <ul style="list-style-type: none"> <li>● Recommended the use of the extraction tool for unmating. Any attempt of unmating by pulling on the cable may result in damage to the mechanical / electrical performance.</li> </ul> </li> <li>• <b>Mating</b> Do not attempt to insert on an extreme angle.</li> </ul> 
(2) Pull forces on the cable after connectors are mated	<p>Do not apply any pull forces after the bending of the cable.</p> 
(3) Precautions	Do not twist connectors excessively during mating / unmating.

### 2. Receptacle

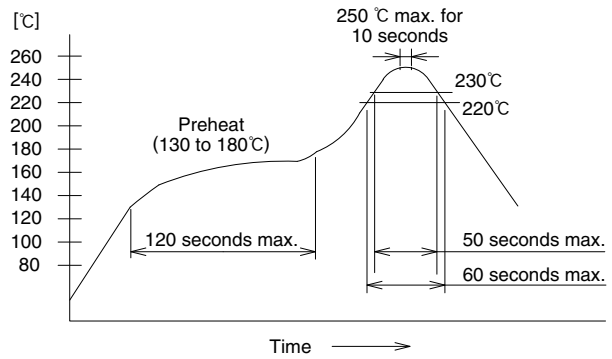
(1) Recommended reflow temperature profile	 <ul style="list-style-type: none"> <li>① The temperature profile indicates the board surface temperature at the point of contacts with the connector leads.</li> <li>② In individual applications the actual temperature may vary, depending on the solder paste type, volume / thickness and board size / thickness. Consult your solder paste and equipment manufacturer for the detailed recommendations.</li> </ul>
(2) Manual soldering	Soldering iron temperature: 350°C, Soldering time: for 5 seconds max.
(3) Recommended metal mask thickness	0.1 mm to 0.12 mm
(4) Reflow cycles	2 times

### 3. Operating environment and storage conditions

(1) Operating environment	<p>The connectors are not designed to operate in the following environments:</p> <ul style="list-style-type: none"> <li>• Exposed to a excessive amounts of fine particles and dust</li> <li>• Regions and places having a high density of sulfur dioxide, hydrogen sulfide, nitrogen dioxide or other corrosive gasses.</li> <li>• Environments having large rapid variations in temperature.</li> </ul>
(2) Storage conditions - Receptacle	<p>Store in the Hirose Electric packaging.          Temperature: -10 to +40°C, Humidity: 85% max.          Use within 6 months of delivery.          Receptacles for which the storage period has elapsed must be tested for solderability to the PC board mounting surface.</p>



**HIROSE ELECTRIC CO.,LTD.**

2-6-3,Nakagawa Chuoh,Tsuzuki-Ku,Yokohama-Shi 224-8540,JAPAN

TEL: +81-45-620-3526 Fax: +81-45-591-3726

<http://www.hirose.com>

<http://www.hirose-connectors.com>

## Looking for pricing, stock, or lifecycle information?

Click below to explore more details on WIN SOURCE:

-  [View N.FL-R-SMT-1\(80\) on WIN SOURCE](#)
-  [Hirose Electric Co Ltd Information](#)

## Optimize Your Supply Chain with WIN SOURCE Solutions

-  Global Sourcing Solution
-  Obsolete Management
-  Cost Control Management
-  Shortage Management
-  Alternative Solution
-  Excess Inventory Management