



Is Now Part of



**ON Semiconductor®**

To learn more about ON Semiconductor, please visit our website at  
[www.onsemi.com](http://www.onsemi.com)

Please note: As part of the Fairchild Semiconductor integration, some of the Fairchild orderable part numbers will need to change in order to meet ON Semiconductor's system requirements. Since the ON Semiconductor product management systems do not have the ability to manage part nomenclature that utilizes an underscore (\_), the underscore (\_) in the Fairchild part numbers will be changed to a dash (-). This document may contain device numbers with an underscore (\_). Please check the ON Semiconductor website to verify the updated device numbers. The most current and up-to-date ordering information can be found at [www.onsemi.com](http://www.onsemi.com). Please email any questions regarding the system integration to [Fairchild\\_questions@onsemi.com](mailto:Fairchild_questions@onsemi.com).

ON Semiconductor and the ON Semiconductor logo are trademarks of Semiconductor Components Industries, LLC dba ON Semiconductor or its subsidiaries in the United States and/or other countries. ON Semiconductor owns the rights to a number of patents, trademarks, copyrights, trade secrets, and other intellectual property. A listing of ON Semiconductor's product/patent coverage may be accessed at [www.onsemi.com/site/pdf/Patent-Marking.pdf](http://www.onsemi.com/site/pdf/Patent-Marking.pdf). ON Semiconductor reserves the right to make changes without further notice to any products herein. ON Semiconductor makes no warranty, representation or guarantee regarding the suitability of its products for any particular purpose, nor does ON Semiconductor assume any liability arising out of the application or use of any product or circuit, and specifically disclaims any and all liability, including without limitation special, consequential or incidental damages. Buyer is responsible for its products and applications using ON Semiconductor products, including compliance with all laws, regulations and safety requirements or standards, regardless of any support or applications information provided by ON Semiconductor. "Typical" parameters which may be provided in ON Semiconductor data sheets and/or specifications can and do vary in different applications and actual performance may vary over time. All operating parameters, including "Typicals" must be validated for each customer application by customer's technical experts. ON Semiconductor does not convey any license under its patent rights nor the rights of others. ON Semiconductor products are not designed, intended, or authorized for use as a critical component in life support systems or any FDA Class 3 medical devices or medical devices with a same or similar classification in a foreign jurisdiction or any devices intended for implantation in the human body. Should Buyer purchase or use ON Semiconductor products for any such unintended or unauthorized application, Buyer shall indemnify and hold ON Semiconductor and its officers, employees, subsidiaries, affiliates, and distributors harmless against all claims, costs, damages, and expenses, and reasonable attorney fees arising out of, directly or indirectly, any claim of personal injury or death associated with such unintended or unauthorized use, even if such claim alleges that ON Semiconductor was negligent regarding the design or manufacture of the part. ON Semiconductor is an Equal Opportunity/Affirmative Action Employer. This literature is subject to all applicable copyright laws and is not for resale in any manner.



# NC7SV05

## TinyLogic® ULP-A Inverter (Open-Drain Output)

### Features

- 0.9V to 3.6V  $V_{CC}$  Supply Operation
- 3.6V Over-Voltage Tolerant I/Os at  $V_{CC}$  from 0.9V to 3.6V
- Extremely High Speed  $t_{PD}$ 
  - 1.0ns: Typical for 2.7V to 3.6V  $V_{CC}$
  - 1.2ns: Typical for 2.3V to 2.7V  $V_{CC}$
  - 2.0ns: Typical for 1.65V to 1.95V  $V_{CC}$
  - 3.2ns: Typical for 1.4V to 1.6V  $V_{CC}$
  - 6.0ns: Typical for 1.1V to 1.3V  $V_{CC}$
  - 13.0ns: Typical for 0.9V  $V_{CC}$
- Power-Off High-Impedance Inputs and Outputs
- High Static Drive ( $I_{OH}/I_{OL}$ )
  - $\pm 24$ mA at 3.00V  $V_{CC}$
  - $\pm 18$ mA at 2.30V  $V_{CC}$
  - $\pm 6$ mA at 1.65V  $V_{CC}$
  - $\pm 4$ mA at 1.4V  $V_{CC}$
  - $\pm 2$ mA at 1.1V  $V_{CC}$
  - $\pm 0.1$ mA at 0.9V  $V_{CC}$
- Uses Proprietary Quiet Series™ Noise/EMI Reduction Circuitry
- Ultra-Small MicroPak™ Packages
- Ultra-Low Dynamic Power

### Description

The NC7SV05 is a single inverter with open-drain output from Fairchild's Ultra-Low Power (ULP-A) Series of TinyLogic®. ULP-A is ideal for applications that require extreme high speed, high drive, and low power. This product is designed for a wide low-voltage operating range (0.9V to 3.6V  $V_{CC}$ ) and applications that require more drive and speed than the TinyLogic® ULP series, but still offer best-in-class, low-power operation.

The NC7SV05 is uniquely designed for optimized power and speed and is fabricated with an advanced CMOS technology to achieve high-speed operation while maintaining low CMOS power dissipation.

### Ordering Information

Part Number	Top Mark	Package	Packing Method
NC7SV05P5X	V05	5-Lead SC70, EIAJ SC-88a, 1.25mm Wide	3000 Units on Tape & Reel
NC7SV05L6X	F9	6-Lead MicroPak™, 1.00mm Wide	5000 Units on Tape & Reel
NC7SV05FHX	F9	6-Lead, MicroPak2, 1x1mm Body, .35mm Pitch	5000 Units on Tape & Reel

TinyLogic® is a registered trademark of Fairchild Semiconductor Corporation.  
MicroPak™ and Quiet Series™ are trademarks of Fairchild Semiconductor Corporation.

## Battery Life

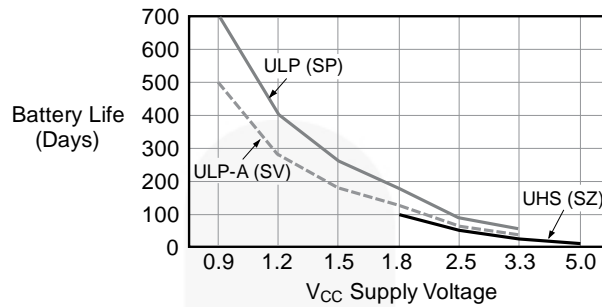

**Figure 1. Battery Life vs. V<sub>CC</sub> Supply Voltage**

**Notes:**

1. TinyLogic® ULP and ULP-A with up to 50% less power consumption can extend battery life significantly.  

$$\text{Battery Life} = (V_{\text{battery}} \cdot I_{\text{battery}} \cdot .9) / (P_{\text{device}}) / 24\text{hrs/day}$$
 where,  $P_{\text{device}} = (I_{\text{CC}} \cdot V_{\text{CC}}) + (C_{\text{PD}} + C_{\text{L}}) \cdot V_{\text{CC}2} \cdot f.$
2. Assumes ideal 3.6V Lithium Ion battery with current rating of 900mAH and derated 90% and device frequency at 10MHz, with C<sub>L</sub>=15pF load.

## Connection Diagram

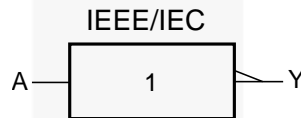

**Figure 2. Logic Symbol**

## Pin Configurations

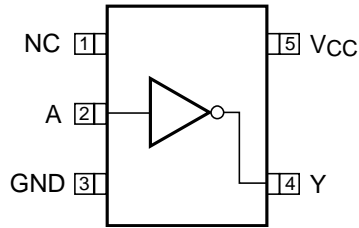

Figure 3. SC70 (Top View)

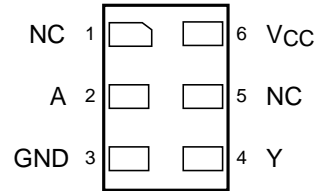

Figure 4. MicroPak (Top Through View)

## Pin Definitions

Pin # SC70	Pin # MicroPak	Name	Description
1	1, 5	NC	No Connect
2	2	A	Input
3	3	GND	Ground
4	4	Y	Output
5	6	V <sub>CC</sub>	Supply Voltage

## Function Table

Inputs	Output
<b>A</b>	<b>Y</b>
L	*H
H	L

H=HIGH Logic Level

L=LOW Logic Level

\*H=HIGH Impedance Output Status (Open Drain)

## Absolute Maximum Ratings

Stresses exceeding the absolute maximum ratings may damage the device. The device may not function or be operable above the recommended operating conditions and stressing the parts to these levels is not recommended. In addition, extended exposure to stresses above the recommended operating conditions may affect device reliability. The absolute maximum ratings are stress ratings only.

Symbol	Parameter		Min.	Max.	Unit
$V_{CC}$	Supply Voltage		-0.5	4.6	V
$V_{IN}$	DC Input Voltage		-0.5	4.6	V
$V_{OUT}$	DC Output Voltage		-0.5	4.6	V
$I_{IK}$	DC Input Diode Current	$V_{IN} < 0V$		-50	mA
$I_{OK}$	DC Output Diode Current	$V_{OUT} < 0V$		-50	mA
$I_{OL}$	DC Output Sink Current			+50	mA
$I_{CC}$ or $I_{GND}$	DC $V_{CC}$ or Ground Current per Supply Pin			±50	mA
$T_{STG}$	Storage Temperature Range		-65	+150	°C
$T_J$	Junction Temperature Under Bias			+150	°C
$T_L$	Junction Lead Temperature, Soldering 10 Seconds			+260	°C
$P_D$	Power Dissipation at +85°C	SC70-5		150	mW
		MicroPak-6		130	
		MicroPak2-6		120	
ESD	Human Body Model, JEDEC:JESD22-A114			4000	V
	Charge Device Model, JEDEC:JESD22-C101			2000	

## Recommended Operating Conditions

The Recommended Operating Conditions table defines the conditions for actual device operation. Recommended operating conditions are specified to ensure optimal performance to the datasheet specifications. Fairchild does not recommend exceeding them or designing to Absolute Maximum Ratings.

Symbol	Parameter	Conditions	Min.	Max.	Unit
$V_{CC}$	Supply Voltage		0.9	3.6	V
$V_{IN}$	Input Voltage		0	3.6	V
$V_{OUT}$	Output Voltage		0	3.6	V
$I_{OL}$	Output Current in $I_{OL}$	$V_{CC}=3.0V$ to $3.6V$		+24.0	mA
		$V_{CC}=2.3V$ to $3.6V$		+18.0	
		$V_{CC}=1.65V$ to $1.95V$		+6.0	
		$V_{CC}=1.4V$ to $1.6V$		+4.0	
		$V_{CC}=1.1V$ to $1.3V$		+2.0	
		$V_{CC}=0.9V$		+0.1	
$T_A$	Operating Temperature, Free Air		-40	+85	°C
$\Delta t/\Delta V$	Minimum Input Edge Rate	$V_{IN}=0.8V$ to $2.0$ , $V_{CC}=3.0V$		10	ns/V
$\theta_{JA}$	Thermal Resistance	SC70-5		425	°C/W
		MicroPak-6		500	
		MicroPak2-6		560	

**Note:**

- Unused inputs must be held HIGH or LOW. They may not float.

### DC Electrical Characteristics

Symbol	Parameter	V <sub>CC</sub>	Conditions	T <sub>A</sub> =25°C		T <sub>A</sub> =-40 to 85°C		Units
				Min.	Max.	Min.	Max.	
V <sub>IH</sub>	HIGH Level Input Voltage	0.90		.65 x V <sub>CC</sub>		.65 x V <sub>CC</sub>		V
		1.10 ≤ V <sub>CC</sub> ≤ 1.30		.65 x V <sub>CC</sub>		.65 x V <sub>CC</sub>		
		1.40 ≤ V <sub>CC</sub> ≤ 1.60		.65 x V <sub>CC</sub>		.65 x V <sub>CC</sub>		
		1.65 ≤ V <sub>CC</sub> ≤ 1.95		.65 x V <sub>CC</sub>		.65 x V <sub>CC</sub>		
		2.30 ≤ V <sub>CC</sub> ≤ 2.70		1.6		1.6		
		2.70 ≤ V <sub>CC</sub> ≤ 3.60		2.0		2.0		
V <sub>IL</sub>	LOW Level Input Voltage	0.90			.35 x V <sub>CC</sub>		.35 x V <sub>CC</sub>	V
		1.10 ≤ V <sub>CC</sub> ≤ 1.30			.35 x V <sub>CC</sub>		.35 x V <sub>CC</sub>	
		1.40 ≤ V <sub>CC</sub> ≤ 1.60			.35 x V <sub>CC</sub>		.35 x V <sub>CC</sub>	
		1.65 ≤ V <sub>CC</sub> ≤ 1.95			.35 x V <sub>CC</sub>		.35 x V <sub>CC</sub>	
		2.30 ≤ V <sub>CC</sub> ≤ 2.70			0.7		0.7	
		2.70 ≤ V <sub>CC</sub> ≤ 3.60			0.8		0.8	
V <sub>OL</sub>	LOW Level Output Voltage	0.90	I <sub>OL</sub> =100μA		0.1		0.1	V
		1.10 ≤ V <sub>CC</sub> ≤ 1.30			0.1		0.1	
		1.40 ≤ V <sub>CC</sub> ≤ 1.60			0.2		0.2	
		1.65 ≤ V <sub>CC</sub> ≤ 1.95			0.2		0.2	
		2.30 ≤ V <sub>CC</sub> ≤ 2.70			0.2		0.2	
		2.70 ≤ V <sub>CC</sub> ≤ 3.60			0.2		0.2	
		1.10 ≤ V <sub>CC</sub> ≤ 1.30	I <sub>OL</sub> =2mA		0.25 x V <sub>CC</sub>		0.25 x V <sub>CC</sub>	
		1.40 ≤ V <sub>CC</sub> ≤ 1.60	I <sub>OL</sub> =4mA		0.25 x V <sub>CC</sub>		0.25 x V <sub>CC</sub>	
		1.65 ≤ V <sub>CC</sub> ≤ 1.95	I <sub>OL</sub> =6mA		0.3		0.3	
		2.30 ≤ V <sub>CC</sub> ≤ 2.70	I <sub>OL</sub> =12mA		0.4		0.4	
		2.70 ≤ V <sub>CC</sub> ≤ 3.60			0.4		0.4	
		2.30 ≤ V <sub>CC</sub> ≤ 2.70	I <sub>OL</sub> =18mA		0.6		0.6	
		2.70 ≤ V <sub>CC</sub> ≤ 3.60			0.4		0.4	
		2.70 ≤ V <sub>CC</sub> ≤ 3.60	I <sub>OL</sub> =24mA		0.55		0.55	
I <sub>IN</sub>	Input Leakage Current	0.90 to 3.60	0 ≤ V <sub>IN</sub> ≤ 3.60		±0.1		±0.5	μA
I <sub>OFF</sub>	Power Off Leakage Current	0	0 ≤ (V <sub>IN</sub> , V <sub>O</sub> ) ≤ 3.60		0.5		0.5	μA
I <sub>CC</sub>	Quiescent Supply Current	0.90 to 3.60	V <sub>IN</sub> =V <sub>CC</sub> , or GND		0.9		0.9	μA
			V <sub>CC</sub> ≤ V <sub>IN</sub> ≤ 3.6V				±0.9	

### AC Electrical Characteristics

Symbol	Parameter	V <sub>CC</sub>	Conditions	T <sub>A</sub> =25°C			T <sub>A</sub> =-40 to 85°C		Units	Figure
				Min.	Typ.	Max.	Min.	Max.		
t <sub>pZL</sub> , t <sub>pLZ</sub>	Propagation Delay	0.90	C <sub>L</sub> =15pF, R <sub>U</sub> =R <sub>D</sub> =1kΩ		13				ns	Figure 5 Figure 6
		1.10 ≤ V <sub>CC</sub> ≤ 1.30	C <sub>L</sub> =30pF, R <sub>U</sub> =R <sub>D</sub> =1kΩ	3.0	6.0	15.0	1.0	18.6		
		1.40 ≤ V <sub>CC</sub> ≤ 1.60	C <sub>L</sub> =30pF, R <sub>U</sub> =R <sub>D</sub> =1kΩ	1.0	3.2	8.7	1.0	9.7		
		1.65 ≤ V <sub>CC</sub> ≤ 1.95	C <sub>L</sub> =30pF, R <sub>U</sub> =R <sub>D</sub> =1kΩ	1.0	2.0	6.0	1.0	6.8		
		2.30 ≤ V <sub>CC</sub> ≤ 2.70	C <sub>L</sub> =30pF, R <sub>U</sub> =R <sub>D</sub> =1kΩ	0.8	1.2	3.6	0.7	4.7		
		2.70 ≤ V <sub>CC</sub> ≤ 3.60	C <sub>L</sub> =30pF, R <sub>U</sub> =R <sub>D</sub> =1kΩ	0.7	1.0	3.3	0.6	4.0		
C <sub>IN</sub>	Input Capacitance	0			2				pF	
C <sub>PD</sub>	Power Dissipation Capacitance	0.90 to 3.60	V <sub>IN</sub> =0V or V <sub>CC</sub> , f=10MHz		10					pF

### AC Loadings and Waveforms

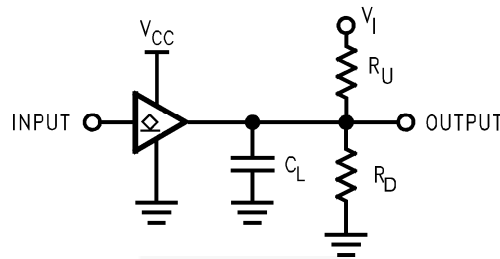

Figure 5. AC Test Circuit

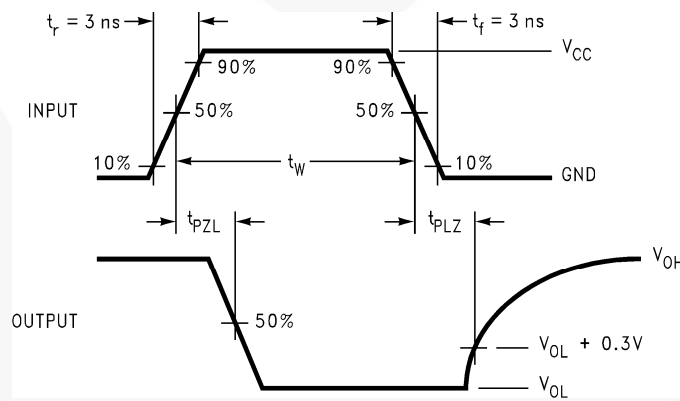
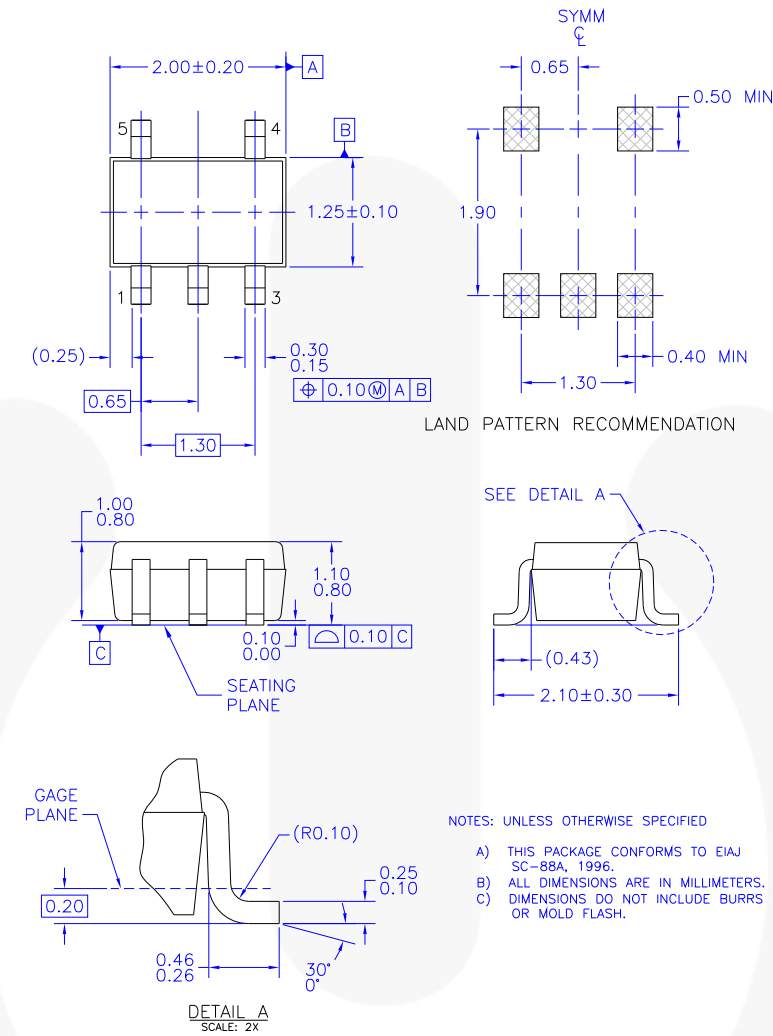

Figure 6. AC Waveforms for Inverting and Non-Inverting Functions

Symbol	V <sub>CC</sub>					
	3.3V ± 0.3V	2.5V ± 0.2V	1.8V ± 0.15V	1.5V ± 0.1V	1.2V ± 0.1V	0.9V
V <sub>mi</sub>	1.5V	V <sub>CC</sub> /2	V <sub>CC</sub> /2	V <sub>CC</sub> /2	V <sub>CC</sub> /2	V <sub>CC</sub> /2
V <sub>mo</sub>	V <sub>OL</sub> + 0.30V	V <sub>OL</sub> + 0.15V	V <sub>OL</sub> + 0.15V	V <sub>OL</sub> + 0.10V	V <sub>OL</sub> + 0.10V	V <sub>OL</sub> + 0.10V

## Physical Dimensions



MAA05AREV5

**Figure 7. 5-Lead, SC70, EIAJ SC-88a, 1.25mm Wide**

Package drawings are provided as a service to customers considering Fairchild components. Drawings may change in any manner without notice. Please note the revision and/or date on the drawing and contact a Fairchild Semiconductor representative to verify or obtain the most recent revision. Package specifications do not expand the terms of Fairchild's worldwide terms and conditions, specifically the warranty therein, which covers Fairchild products.

Always visit Fairchild Semiconductor's online packaging area for the most recent package drawings:  
<http://www.fairchildsemi.com/packaging/>.

## Tape and Reel Specification

Please visit Fairchild Semiconductor's online packaging area for the most recent tape and reel specifications:  
[http://www.fairchildsemi.com/products/analog/pdf/sc70-5\\_tr.pdf](http://www.fairchildsemi.com/products/analog/pdf/sc70-5_tr.pdf).

Package Designator	Tape Section	Cavity Number	Cavity Status	Cover Type Status
P5X	Leader (Start End)	125 (Typical)	Empty	Sealed
	Carrier	3000	Filled	Sealed
	Trailer (Hub End)	75 (Typical)	Empty	Sealed

## Physical Dimensions

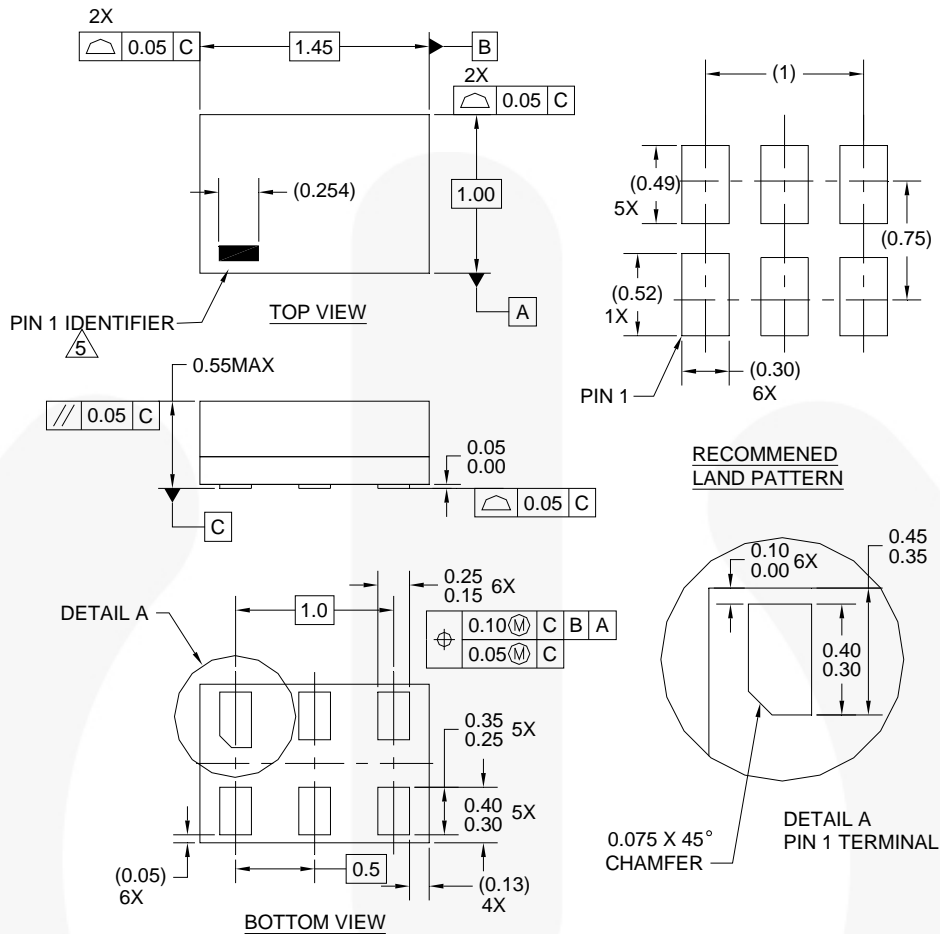

- Notes:
1. CONFORMS TO JEDEC STANDARD M0-252 VARIATION UAAD
  2. DIMENSIONS ARE IN MILLIMETERS
  3. DRAWING CONFORMS TO ASME Y14.5M-1994
  4. FILENAME AND REVISION: MAC06AREV4
-  PIN ONE IDENTIFIER IS 2X LENGTH OF ANY OTHER LINE IN THE MARK CODE LAYOUT.

**Figure 8. 6-Lead, MicroPak™, 1.0mm Wide**

Package drawings are provided as a service to customers considering Fairchild components. Drawings may change in any manner without notice. Please note the revision and/or date on the drawing and contact a Fairchild Semiconductor representative to verify or obtain the most recent revision. Package specifications do not expand the terms of Fairchild's worldwide terms and conditions, specifically the warranty therein, which covers Fairchild products.

Always visit Fairchild Semiconductor's online packaging area for the most recent package drawings:  
<http://www.fairchildsemi.com/packaging/>.

## Tape and Reel Specification

Please visit Fairchild Semiconductor's online packaging area for the most recent tape and reel specifications:  
[http://www.fairchildsemi.com/products/logic/pdf/micropak\\_tr.pdf](http://www.fairchildsemi.com/products/logic/pdf/micropak_tr.pdf).

Package Designator	Tape Section	Cavity Number	Cavity Status	Cover Type Status
L6X	Leader (Start End)	125 (Typical)	Empty	Sealed
	Carrier	5000	Filled	Sealed
	Trailer (Hub End)	75 (Typical)	Empty	Sealed

## Physical Dimensions

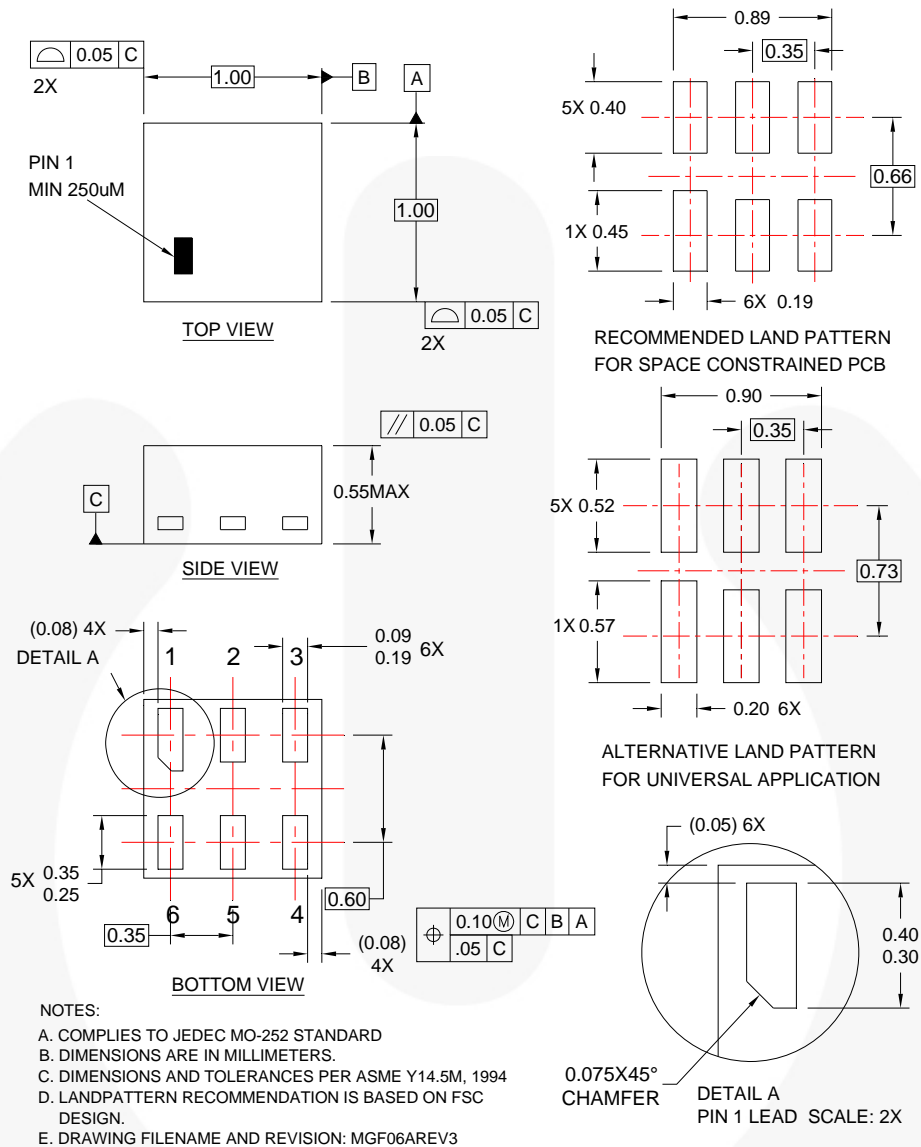

**Figure 9. 6-Lead, MicroPak2, 1x1mm Body, .35mm Pitch**

Package drawings are provided as a service to customers considering Fairchild components. Drawings may change in any manner without notice. Please note the revision and/or date on the drawing and contact a Fairchild Semiconductor representative to verify or obtain the most recent revision. Package specifications do not expand the terms of Fairchild's worldwide terms and conditions, specifically the warranty therein, which covers Fairchild products.

Always visit Fairchild Semiconductor's online packaging area for the most recent package drawings:  
<http://www.fairchildsemi.com/packaging/>.

## Tape and Reel Specification





Please visit Fairchild Semiconductor's online packaging area for the most recent tape and reel specifications:  
[http://www.fairchildsemi.com/packaging/MicroPAK2\\_6L\\_tr.pdf](http://www.fairchildsemi.com/packaging/MicroPAK2_6L_tr.pdf).

Package Designator	Tape Section	Cavity Number	Cavity Status	Cover Type Status
FHX	Leader (Start End)	125 (Typical)	Empty	Sealed
	Carrier	5000	Filled	Sealed
	Trailer (Hub End)	75 (Typical)	Empty	Sealed



**TRADEMARKS**

The following includes registered and unregistered trademarks and service marks, owned by Fairchild Semiconductor and/or its global subsidiaries, and is not intended to be an exhaustive list of all such trademarks.

- |   |  |  |   |
|---|--|--|---|
| 2Cool™  | FPS™   | PDP SPM™   | The Power Franchise®  |
| AccuPower™  | F-PFS™   | Power-SPM™   | <b>the power franchise</b>  |
| Auto-SPM™   | FRFET®   | PowerTrench®   | TinyBoost™  |
| AX-CAP™*  | Global Power Resource™                         | PowerXST™  | TinyBuck™   |
| BitSIC®   | Green FPS™                                     | Programmable Active Droop™   | TinyCalc™   |
| Build it Now™   | Green FPS™ e-Series™                           | QFET®  | TinyLogic®  |
| CorePLUS™   | Gmax™  | QST™   | TINYOPTO™   |
| CorePOWER™  | GTO™   | Quiet Series™  | TinyPower™  |
| CROSSVOL7™  | IntelliMAX™                                    | RapidConfigure™  | TinyPVM™  |
| CTL™  | ISOPLANAR™                                     |  ™                | TinyWire™   |
| Current Transfer Logic™   | Making Small Speakers Sound Louder and Better™ | Saving our world, 1mV/W/KW at a time™  | TranSiC®  |
| DEUXPEED®   | MegaBuck™                                      | SignalWise™  | TriFault Detect™  |
| Dual Cool™  | MICROCOUPLER™                                  | SmartMax™  | TRUECURRENT®*   |
| EcoSPARK®   | MicroFET™                                      | SMART START™   | μSerDes™  |
| EfficientMax™   | MicroPak™                                      | SPM®   |  |
| ESBC™   | MicroPak2™                                     | STEALTH™   | UHC®  |
|  | MillerDrive™                                   | SuperFET®  | Ultra FRFET™  |
| Fairchild®  | MotionMax™                                     | SuperSOT™-3  | UniFET™   |
| Fairchild Semiconductor®  | Motion-SPM™                                    | SuperSOT™-6  | VCM™  |
| FACT Quiet Series™  | mWSaver™                                       | SuperSOT™-8  | VisualMax™  |
| FACT®   | OptoHiT™                                       | SupreMOS®  | VoltagePlus™  |
| FAST®   | OPTOLOGIC®                                     | SyncFET™   | XST™  |
| FastvCore™  | OPTOPLANAR®                                    | Sync-Lock™   |   |
| FETBench™   |  |  SYSTEM GENERAL®* |   |
| FlashWriter®*   |  |  |   |

\* Trademarks of System General Corporation, used under license by Fairchild Semiconductor.

**DISCLAIMER**

FAIRCHILD SEMICONDUCTOR RESERVES THE RIGHT TO MAKE CHANGES WITHOUT FURTHER NOTICE TO ANY PRODUCTS HEREIN TO IMPROVE RELIABILITY, FUNCTION, OR DESIGN. FAIRCHILD DOES NOT ASSUME ANY LIABILITY ARISING OUT OF THE APPLICATION OR USE OF ANY PRODUCT OR CIRCUIT DESCRIBED HEREIN; NEITHER DOES IT CONVEY ANY LICENSE UNDER ITS PATENT RIGHTS, NOR THE RIGHTS OF OTHERS. THESE SPECIFICATIONS DO NOT EXPAND THE TERMS OF FAIRCHILD'S WORLDWIDE TERMS AND CONDITIONS, SPECIFICALLY THE WARRANTY THEREIN, WHICH COVERS THESE PRODUCTS.

**LIFE SUPPORT POLICY**

FAIRCHILD'S PRODUCTS ARE NOT AUTHORIZED FOR USE AS CRITICAL COMPONENTS IN LIFE SUPPORT DEVICES OR SYSTEMS WITHOUT THE EXPRESS WRITTEN APPROVAL OF FAIRCHILD SEMICONDUCTOR CORPORATION.

As used herein:

1. Life support devices or systems are devices or systems which, (a) are intended for surgical implant into the body or (b) support or sustain life, and (c) whose failure to perform when properly used in accordance with instructions for use provided in the labeling, can be reasonably expected to result in a significant injury of the user.
2. A critical component in any component of a life support, device, or system whose failure to perform can be reasonably expected to cause the failure of the life support device or system, or to affect its safety or effectiveness.

**ANTI-COUNTERFEITING POLICY**

Fairchild Semiconductor Corporation's Anti-Counterfeiting Policy. Fairchild's Anti-Counterfeiting Policy is also stated on our external website, [www.fairchildsemi.com](http://www.fairchildsemi.com), under Sales Support.

Counterfeiting of semiconductor parts is a growing problem in the industry. All manufacturers of semiconductor products are experiencing counterfeiting of their parts. Customers who inadvertently purchase counterfeit parts experience many problems such as loss of brand reputation, substandard performance, failed applications, and increased cost of production and manufacturing delays. Fairchild is taking strong measures to protect ourselves and our customers from the proliferation of counterfeit parts. Fairchild strongly encourages customers to purchase Fairchild parts either directly from Fairchild or from Authorized Fairchild Distributors who are listed by country on our web page cited above. Products customers buy either from Fairchild directly or from Authorized Fairchild Distributors are genuine parts, have full traceability, meet Fairchild's quality standards for handling and storage and provide access to Fairchild's full range of up-to-date technical and product information. Fairchild and our Authorized Distributors will stand behind all warranties and will appropriately address any warranty issues that may arise. Fairchild will not provide any warranty coverage or other assistance for parts bought from Unauthorized Sources. Fairchild is committed to combat this global problem and encourage our customers to do their part in stopping this practice by buying direct or from authorized distributors.

**PRODUCT STATUS DEFINITIONS**

**Definition of Terms**

Datasheet Identification	Product Status	Definition
Advance Information	Formative / In Design	Datasheet contains the design specifications for product development. Specifications may change in any manner without notice.
Preliminary	First Production	Datasheet contains preliminary data; supplementary data will be published at a later date. Fairchild Semiconductor reserves the right to make changes at any time without notice to improve design.
No Identification Needed	Full Production	Datasheet contains final specifications. Fairchild Semiconductor reserves the right to make changes at any time without notice to improve the design.
Obsolete	Not In Production	Datasheet contains specifications on a product that is discontinued by Fairchild Semiconductor. The datasheet is for reference information only.

Rev. I57

ON Semiconductor and  are trademarks of Semiconductor Components Industries, LLC dba ON Semiconductor or its subsidiaries in the United States and/or other countries. ON Semiconductor owns the rights to a number of patents, trademarks, copyrights, trade secrets, and other intellectual property. A listing of ON Semiconductor's product/patent coverage may be accessed at [www.onsemi.com/site/pdf/Patent-Marking.pdf](http://www.onsemi.com/site/pdf/Patent-Marking.pdf). ON Semiconductor reserves the right to make changes without further notice to any products herein. ON Semiconductor makes no warranty, representation or guarantee regarding the suitability of its products for any particular purpose, nor does ON Semiconductor assume any liability arising out of the application or use of any product or circuit, and specifically disclaims any and all liability, including without limitation special, consequential or incidental damages. Buyer is responsible for its products and applications using ON Semiconductor products, including compliance with all laws, regulations and safety requirements or standards, regardless of any support or applications information provided by ON Semiconductor. "Typical" parameters which may be provided in ON Semiconductor data sheets and/or specifications can and do vary in different applications and actual performance may vary over time. All operating parameters, including "Typicals" must be validated for each customer application by customer's technical experts. ON Semiconductor does not convey any license under its patent rights nor the rights of others. ON Semiconductor products are not designed, intended, or authorized for use as a critical component in life support systems or any FDA Class 3 medical devices or medical devices with a same or similar classification in a foreign jurisdiction or any devices intended for implantation in the human body. Should Buyer purchase or use ON Semiconductor products for any such unintended or unauthorized application, Buyer shall indemnify and hold ON Semiconductor and its officers, employees, subsidiaries, affiliates, and distributors harmless against all claims, costs, damages, and expenses, and reasonable attorney fees arising out of, directly or indirectly, any claim of personal injury or death associated with such unintended or unauthorized use, even if such claim alleges that ON Semiconductor was negligent regarding the design or manufacture of the part. ON Semiconductor is an Equal Opportunity/Affirmative Action Employer. This literature is subject to all applicable copyright laws and is not for resale in any manner.

## PUBLICATION ORDERING INFORMATION

### LITERATURE FULFILLMENT:

Literature Distribution Center for ON Semiconductor  
19521 E. 32nd Pkwy, Aurora, Colorado 80011 USA  
**Phone:** 303-675-2175 or 800-344-3860 Toll Free USA/Canada  
**Fax:** 303-675-2176 or 800-344-3867 Toll Free USA/Canada  
**Email:** [orderlit@onsemi.com](mailto:orderlit@onsemi.com)

**N. American Technical Support:** 800-282-9855 Toll Free  
USA/Canada  
**Europe, Middle East and Africa Technical Support:**  
Phone: 421 33 790 2910  
**Japan Customer Focus Center**  
Phone: 81-3-5817-1050

**ON Semiconductor Website:** [www.onsemi.com](http://www.onsemi.com)  
**Order Literature:** <http://www.onsemi.com/orderlit>  
For additional information, please contact your local  
Sales Representative

## Looking for pricing, stock, or lifecycle information?

Click below to explore more details on WIN SOURCE:

- ⊖ [View NC7SV05L6X on WIN SOURCE](#)
- ⊖ [Fairchild/ON Semiconductor Information](#)

## Optimize Your Supply Chain with WIN SOURCE Solutions

- ✓ Global Sourcing Solution
- ✓ Obsolete Management
- ✓ Cost Control Management
- ✓ Shortage Management
- ✓ Alternative Solution
- ✓ Excess Inventory Management