



**THE DATASHEET OF
NC7WP240L8X**



NC7WP240 TinyLogic® ULP Dual Inverting Buffer with 3-STATE Outputs

General Description

The NC7WP240 is a Dual Inverting Buffer with independent active LOW enables for the 3-STATE outputs. The Ultra High Power device is ideal for applications where battery life is critical. This product is designed for ultra low power consumption within the V_{CC} operating range of 0.9V to 3.6V V_{CC} .

The internal circuit is composed of a minimum of inverter stages, including the output buffer, to enable ultra low static and dynamic power.

The NC7WP240 for lower drive requirements, is uniquely designed for optimized power and speed, and is fabricated with an advanced CMOS technology to achieve best in class speed operation while maintaining extremely low CMOS power dissipation.

Features

- Space saving US8 surface mount package
- MicroPak™ Pb-Free leadless package
- 0.9V to 3.6V V_{CC} supply operation
- 3.6V overvoltage tolerant I/O's at V_{CC} from 0.9V to 3.6V
- t_{PD}
 - 3.0 ns typ for 3.6V V_{CC}
 - 4.0 ns typ for 2.3V to 2.7V V_{CC}
 - 5.0 ns typ for 1.65V to 1.95V V_{CC}
 - 6.0 ns typ for 1.40V to 1.60V V_{CC}
 - 10.0 ns typ for 1.10V to 1.30V V_{CC}
 - 26.0 ns typ for 0.90V V_{CC}
- Power-Off high impedance inputs and outputs
- Static Drive (I_{OH}/I_{OL})
 - ±2.6 mA @ 3.00V V_{CC}
 - ±2.1 mA @ 2.30V V_{CC}
 - ±1.5 mA @ 1.65V V_{CC}
 - ±1.0 mA @ 1.40V V_{CC}
 - ±0.5 mA @ 1.10V V_{CC}
 - ±20 μ A @ 0.9V V_{CC}
- Uses patented Quiet Series™ noise/EMI reduction circuitry
- Ultra low dynamic power

Ordering Code:

Order Number	Package Number	Product Code Top Mark	Package Description	Supplied As
NC7WP240K8X	MAB08A	WP40	8-Lead US8, JEDEC MO-187, Variation CA 3.1mm Wide	3k Units on Tape and Reel
NC7WP240L8X	MAC08A	Z3	Pb-Free 8-Lead MicroPak, 1.6 mm Wide	5k Units on Tape and Reel

Pb-Free package per JEDEC J-STD-020B.

Battery Life vs. V_{CC} Supply Voltage

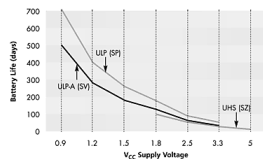

TinyLogic ULP and ULP-A with up to 50% less power consumption can extend your battery life significantly.

$$\text{Battery Life} = (V_{\text{battery}} \cdot I_{\text{battery}} \cdot 9) / (P_{\text{device}}) / 24 \text{hrs/day}$$

$$\text{Where, } P_{\text{device}} = (I_{CC} \cdot V_{CC}) + (C_{PD} + C_L) \cdot V_{CC}^2 \cdot f$$

Assumes ideal 3.6V Lithium Ion battery with current rating of 900mAh and derated 90% and device frequency at 10MHz, with $C_L = 15$ pF load

TinyLogic® is a registered trademark of Fairchild Semiconductor Corporation.

MicroPak™ and Quiet Series™ are trademarks of Fairchild Semiconductor Corporation.

Logic Symbol

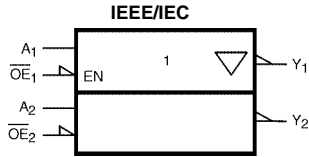

Pin Descriptions

Pin Names	Description
\overline{OE}_n	Enable Inputs for 3-STATE Outputs
A_n	Inputs
Y_n	3-STATE Outputs

Function Table

Inputs		Output
\overline{OE}	A_n	Y_n
L	L	H
L	H	L
H	L	Z
H	H	Z

H = HIGH Logic Level
 L = LOW Logic Level
 Z = 3-STATE

Connection Diagrams

Pin Assignments for US8

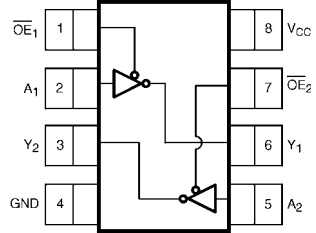

(Top View)

Pin One Orientation Diagram

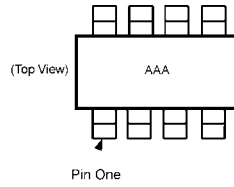

AAA represents Product Code Top Mark - see ordering code
Note: Orientation of Top Mark determines Pin One location. Read the top product code mark left to right, Pin One is the lower left pin (see diagram).

Pad Assignment for MicroPak

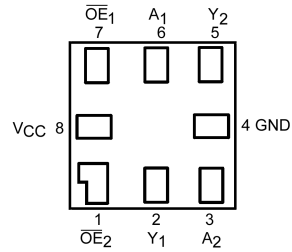

(Top Thru View)

Absolute Maximum Ratings (Note 1)			Recommended Operating Conditions (Note 3)					
Supply Voltage (V_{CC})	-0.5V to +4.6V		Supply Voltage	0.9V to 3.6V				
DC Input Voltage (V_{IN})	-0.5V to +4.6V		Input Voltage (V_{IN})	0V to 3.6V				
DC Output Voltage (V_{OUT})			Output Voltage (V_{OUT})					
HIGH or LOW State (Note 2)	-0.5V to V_{CC} +0.5V		HIGH or LOW State	0V to V_{CC}				
$V_{CC} = 0V$	-0.5V to +4.6V		$V_{CC} = 0V$	0V to 3.6V				
DC Input Diode Current (I_{IK}) $V_{IN} < 0V$	±50 mA		Output Current in I_{OH}/I_{OL}					
DC Output Diode Current (I_{OK})			$V_{CC} = 3.0V$ to 3.6V	±2.6 mA				
$V_{OUT} < 0V$	-50 mA		$V_{CC} = 2.3V$ to 2.7V	±2.1 mA				
$V_{OUT} > V_{CC}$	+50 mA		$V_{CC} = 1.65V$ to 1.95V	±1.5 mA				
DC Output Source/Sink Current (I_{OH}/I_{OL})	± 50 mA		$V_{CC} = 1.40V$ to 1.60V	±1.0 mA				
DC V_{CC} /Ground Current per			$V_{CC} = 1.10V$ to 1.30V	±0.5 mA				
Supply Pin (I_{CC} or Ground)	±50 mA		$V_{CC} = 0.9V$	±20 μA				
Storage Temperature Range (T_{STG})	-65°C to +150°C		Free Air Operating Temperature (T_A)	-40°C to +85°C				
			Minimum Input Edge Rate ($\Delta t/\Delta V$)					
			$V_{IN} = 0.8V$ to 2.0V, $V_{CC} = 3.0V$	10 ns/V				
			<p>Note 1: Absolute Maximum Ratings: are those values beyond which the safety of the device cannot be guaranteed. The device should not be operated at these limits. The parametric values defined in the Electrical Characteristics tables are not guaranteed at the absolute maximum ratings. The "Recommended Operating Conditions" table will define the conditions for actual device operation.</p> <p>Note 2: I_O Absolute Maximum Rating must be observed.</p> <p>Note 3: Unused inputs must be held HIGH or LOW. They may not float.</p>					
DC Electrical Characteristics								
Symbol	Parameter	V_{CC} (V)	$T_A = +25^\circ C$		$T_A = -40^\circ C$ to $+85^\circ C$		Units	Conditions
			Min	Max	Min	Max		
V_{IH}	HIGH Level Input Voltage	0.90	0.65 x V_{CC}		0.65 x V_{CC}		V	
		$1.10 \leq V_{CC} \leq 1.30$	0.65 x V_{CC}		0.65 x V_{CC}			
		$1.40 \leq V_{CC} \leq 1.60$	0.65 x V_{CC}		0.65 x V_{CC}			
		$1.65 \leq V_{CC} \leq 1.95$	0.65 x V_{CC}		0.65 x V_{CC}			
		$2.30 \leq V_{CC} \leq 2.70$	1.6		1.6			
	$3.00 \leq V_{CC} \leq 3.60$	2.1		2.1				
V_{IL}	LOW Level Input Voltage	0.90		0.35 x V_{CC}		0.35 x V_{CC}	V	
		$1.10 \leq V_{CC} \leq 1.30$		0.35 x V_{CC}		0.35 x V_{CC}		
		$1.40 \leq V_{CC} \leq 1.60$		0.35 x V_{CC}		0.35 x V_{CC}		
		$1.65 \leq V_{CC} \leq 1.95$		0.35 x V_{CC}		0.35 x V_{CC}		
		$2.30 \leq V_{CC} \leq 2.70$		0.7		0.7		
	$3.00 \leq V_{CC} \leq 3.60$		0.9		0.9			
V_{OH}	HIGH Level Output Voltage	0.90	$V_{CC} - 0.1$		$V_{CC} - 0.1$		V	$I_{OH} = -20 \mu A$
		$1.10 \leq V_{CC} \leq 1.30$	$V_{CC} - 0.1$		$V_{CC} - 0.1$			
		$1.40 \leq V_{CC} \leq 1.60$	$V_{CC} - 0.1$		$V_{CC} - 0.1$			
		$1.65 \leq V_{CC} \leq 1.95$	$V_{CC} - 0.1$		$V_{CC} - 0.1$			
		$2.30 \leq V_{CC} \leq 2.70$	$V_{CC} - 0.1$		$V_{CC} - 0.1$			
		$3.00 \leq V_{CC} \leq 3.60$	$V_{CC} - 0.1$		$V_{CC} - 0.1$			
		$1.10 \leq V_{CC} \leq 1.30$	0.75 x V_{CC}		0.70 x V_{CC}			
		$1.40 \leq V_{CC} \leq 1.60$	1.70		0.99			
		$1.65 \leq V_{CC} \leq 1.95$	1.24		1.22			
		$2.30 \leq V_{CC} \leq 2.70$	1.95		1.87			
	$3.00 \leq V_{CC} \leq 3.60$	2.61		2.55				

DC Electrical Characteristics (Continued)

Symbol	Parameter	V _{CC} (V)	T _A = +25°C		T _A = -40°C to +85°C		Units	Conditions	
			Min	Max	Min	Max			
V _{OL}	LOW Level	0.90		0.1		0.1			
	Output Voltage	1.10 ≤ V _{CC} ≤ 1.30		0.1		0.1	V	I _{OL} = 20 μA	
		1.40 ≤ V _{CC} ≤ 1.60		0.1		0.1			
		1.65 ≤ V _{CC} ≤ 1.95		0.1		0.1			
		2.30 ≤ V _{CC} ≤ 2.70		0.1		0.1			
		3.00 ≤ V _{CC} ≤ 3.60		0.1		0.1			
		1.10 ≤ V _{CC} ≤ 1.30		0.30 x V _{CC}		0.30 x V _{CC}			I _{OL} = 0.5 mA
		1.40 ≤ V _{CC} ≤ 1.60		0.31		0.37			I _{OL} = 1.0 mA
		1.65 ≤ V _{CC} ≤ 1.95		0.31		0.35			I _{OL} = 1.5 mA
		2.30 ≤ V _{CC} ≤ 2.70		0.31		0.33			I _{OL} = 2.1 mA
	3.00 ≤ V _{CC} ≤ 3.60		0.31		0.33	I _{OL} = 2.6 mA			
I _{IN}	Input Leakage Current	0.90 to 3.60		±0.1		±0.5	μA	0 ≤ V _I ≤ 3.6V	
I _{OZ}	3-STATE Output Leakage	0.90 to 3.60		±0.5		±0.5	μA	V _I = V _{IH} or V _{IL} 0 ≤ V _O ≤ 3.6V	
I _{OFF}	Power Off Leakage Current	0		0.5		0.5	μA	0 ≤ (V _I , V _O) ≤ 3.6V	
I _{CC}	Quiescent Supply Current	0.90 to 3.60		0.9		0.9	μA	V _I = V _{CC} or GND	

AC Electrical Characteristics

Symbol	Parameter	V _{CC} (V)	T _A = +25°C			T _A = -40°C to +85°C		Units	Conditions	Figure Number
			Min	Typ	Max	Min	Max			
t _{PHL} , t _{PLH}	Propagation Delay	0.90		26.0				ns	C _L = 10 pF R _L = 1 MΩ	Figures 1, 2
		1.10 ≤ V _{CC} ≤ 1.30	4.0	10.0	19.1	3.5	39.6			
		1.40 ≤ V _{CC} ≤ 1.60	2.0	6.0	11.2	1.5	14.5			
		1.65 ≤ V _{CC} ≤ 1.95	1.5	5.0	8.6	1.0	11.6			
		2.30 ≤ V _{CC} ≤ 2.70	1.0	4.0	6.3	0.8	8.2			
	3.00 ≤ V _{CC} ≤ 3.60	1.0	3.0	5.3	0.5	7.2				
t _{PZH} , t _{PZL}	Output Enable Time	0.90		29.0				ns	C _L = 10 pF R _U = 500Ω R _D = 5000Ω S ₁ = GND for t _{PZH} S ₁ = V _I for t _{PZL}	Figures 1, 2
		1.10 ≤ V _{CC} ≤ 1.30	4.0	8.0	17.5	3.5	40.4			
		1.40 ≤ V _{CC} ≤ 1.60	2.0	6.0	11.9	1.5	14.8			
		1.65 ≤ V _{CC} ≤ 1.95	1.5	5.0	9.7	1.0	12.3			
		2.30 ≤ V _{CC} ≤ 2.70	1.0	4.0	7.7	0.8	10.5			
	3.00 ≤ V _{CC} ≤ 3.60	1.0	3.0	6.9	0.5	8.6				
t _{PHZ} , t _{PLZ}	Output Disable Time	0.90		28.0				ns	C _L = 10 pF R _U = 500Ω R _D = 5000Ω S ₁ = GND for t _{PHZ} S ₁ = V _I for t _{PLZ}	Figures 1, 2
		1.10 ≤ V _{CC} ≤ 1.30	4.0	8.0	20.5	3.5	42.0			
		1.40 ≤ V _{CC} ≤ 1.60	2.0	6.0	15.3	1.5	18.0			
		1.65 ≤ V _{CC} ≤ 1.95	1.5	5.0	14.7	1.0	17.8			
		2.30 ≤ V _{CC} ≤ 2.70	1.0	4.0	13.7	0.8	15.0			
	3.00 ≤ V _{CC} ≤ 3.60	1.0	3.0	13.5	0.5	14.8				
t _{PHL} , t _{PLH}	Propagation Delay	0.90		28.0				ns	C _L = 15 pF R _L = 1 MΩ	Figures 1, 2
		1.10 ≤ V _{CC} ≤ 1.30	5.0	10.0	20.5	4.5	42.5			
		1.40 ≤ V _{CC} ≤ 1.60	3.0	7.0	11.8	2.5	15.4			
		1.65 ≤ V _{CC} ≤ 1.95	2.0	5.0	9.1	2.0	12.2			
		2.30 ≤ V _{CC} ≤ 2.70	1.5	4.0	6.6	1.0	8.6			
	3.00 ≤ V _{CC} ≤ 3.60	1.0	3.0	5.6	0.5	7.5				
t _{PZH} , t _{PZL}	Output Enable Time	0.90		31.0				ns	C _L = 15 pF R _U = 5000Ω R _D = 5000Ω S ₁ = GND for t _{PZH} S ₁ = V _I for t _{PZL}	Figures 1, 2
		1.10 ≤ V _{CC} ≤ 1.30	5.0	11.0	18.2	4.5	43.3			
		1.40 ≤ V _{CC} ≤ 1.60	3.0	7.0	12.5	2.5	15.5			
		1.65 ≤ V _{CC} ≤ 1.95	2.0	5.0	10.2	2.0	12.9			
		2.30 ≤ V _{CC} ≤ 2.70	1.5	4.0	8.0	1.0	9.9			
	3.00 ≤ V _{CC} ≤ 3.60	1.0	3.0	7.2	0.5	8.9				

AC Electrical Characteristics (Continued)										
Symbol	Parameter	V _{CC} (V)	T _A = +25°C			T _A = -40°C to +85°C		Units	Conditions	Figure Number
			Min	Typ	Max	Min	Max			
t _{PHZ} , t _{PLZ}	Output Disable Time	0.90 1.10 ≤ V _{CC} ≤ 1.30 1.40 ≤ V _{CC} ≤ 1.60 1.65 ≤ V _{CC} ≤ 1.95 2.30 ≤ V _{CC} ≤ 2.70 3.00 ≤ V _{CC} ≤ 3.60	5.0 3.0 2.0 1.5 1.0	30.0 11.0 7.0 5.0 4.0 3.0	21.6 15.9 15.2 14.1 13.9	4.5 2.5 2.0 1.0 0.5	44.9 18.8 18.2 15.4 15.1	ns	C _L = 15 pF R _U = 5000Ω R _D = 5000Ω S ₁ = GND for t _{PHZ} S ₁ = V _I for t _{PLZ}	Figures 1, 2
t _{PHL} , t _{PLH}	Propagation Delay	0.90 1.10 ≤ V _{CC} ≤ 1.30 1.40 ≤ V _{CC} ≤ 1.60 1.65 ≤ V _{CC} ≤ 1.95 2.30 ≤ V _{CC} ≤ 2.70 3.00 ≤ V _{CC} ≤ 3.60	5.5 4.0 2.0 1.0 0.8	34.0 12.0 8.0 6.0 5.0 4.0	23.4 13.8 10.6 7.6 6.4	5.0 3.0 2.0 1.0 0.5	51.1 17.7 14.0 9.9 8.9	ns	C _L = 30 pF R _L = 1 MΩ	Figures 1, 2
t _{PZH} , t _{PZL}	Output Enable Time	0.90 1.10 ≤ V _{CC} ≤ 1.30 1.40 ≤ V _{CC} ≤ 1.60 1.65 ≤ V _{CC} ≤ 1.95 2.30 ≤ V _{CC} ≤ 2.70 3.00 ≤ V _{CC} ≤ 3.60	6.0 4.0 2.0 1.0 0.8	37.0 13.0 8.0 6.0 5.0 4.0	24.4 14.5 11.7 9.1 8.1	5.0 3.0 2.0 1.0 0.5	51.9 17.9 14.7 11.1 10.1	ns	C _L = 30 pF R _U = 5000Ω R _D = 5000Ω S ₁ = GND for t _{PZH} S ₁ = V _I for t _{PZL}	Figures 1, 2
t _{PHZ} , t _{PLZ}	Output Disable Time	0.90 1.10 ≤ V _{CC} ≤ 1.30 1.40 ≤ V _{CC} ≤ 1.60 1.65 ≤ V _{CC} ≤ 1.95 2.30 ≤ V _{CC} ≤ 2.70 3.00 ≤ V _{CC} ≤ 3.60	6.0 4.0 2.0 1.0 0.8	36.0 13.0 8.0 6.0 5.0 4.0	24.8 17.1 16.5 15.2 14.8	5.0 3.0 2.0 1.0 0.5	53.5 21.1 20.5 16.7 16.3	ns	C _L = 30 pF R _U = 5000Ω R _D = 5000Ω S ₁ = GND for t _{PHZ} S ₁ = V _I for t _{PLZ}	Figures 1, 2
C _{IN}	Input Capacitance	0		2.0				pF		
C _{OUT}	Output Capacitance	0		4.0				pF		
C _{PD}	Power Dissipation Capacitance	0.9 to 3.60		10.0				pF	V _I = V _O or V _{CC} , f = 10 MHz	

AC Loading and Waveforms

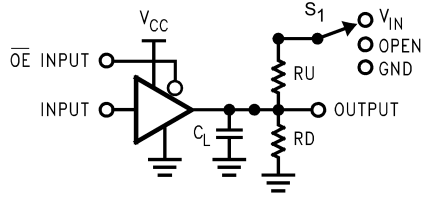

C_L includes load and stray capacitance
 Input PRR = 1.0 MHz; $t_w = 500$ ns

FIGURE 1. AC Test Circuit

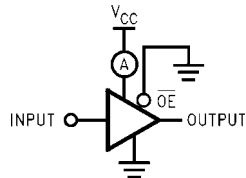

Input = AC Waveform; $t_r = t_f = 1.8$ ns;
 PRR = 10 MHz; Duty Cycle = 50%

FIGURE 2. I_{CCD} Test Circuit

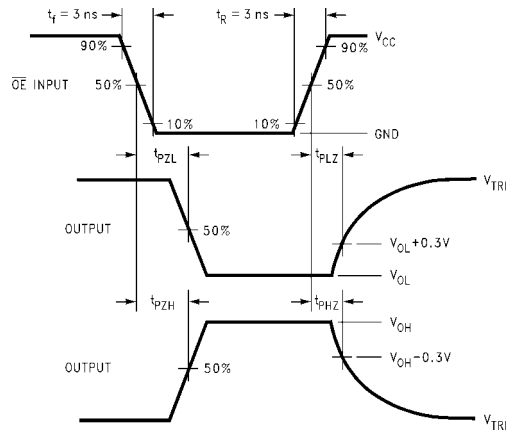
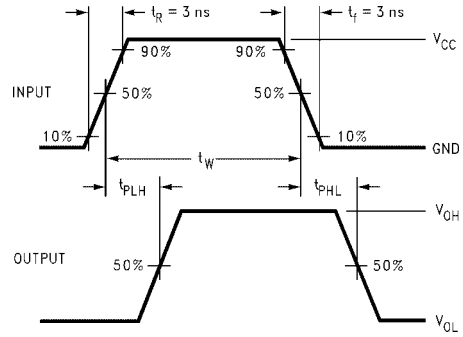
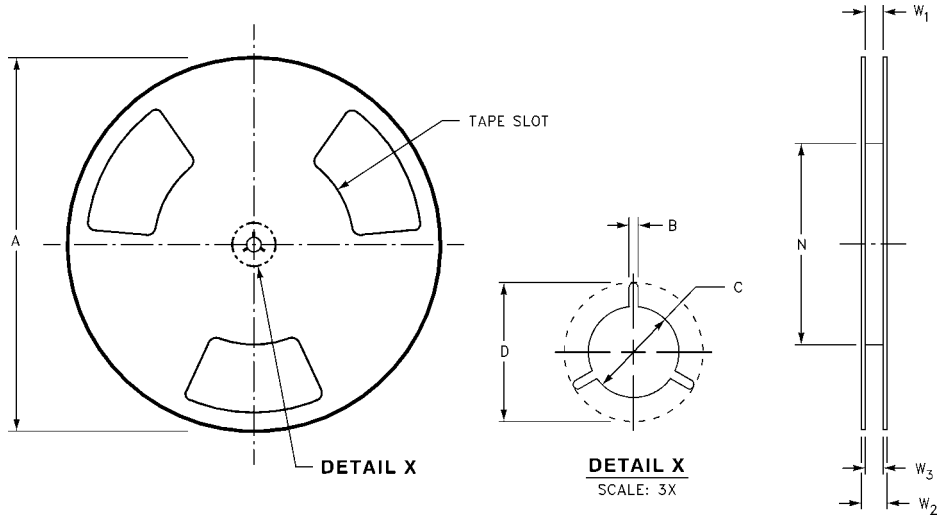

FIGURE 3. AC Waveforms

Symbol	V_{CC}					
	3.3V ± 0.3V	2.5V ± 0.2V	1.8V ± 0.15V	1.5V ± 0.10V	1.2V ± 0.10V	0.9V
V_{mi}	1.5V	$V_{CC}/2$	$V_{CC}/2$	$V_{CC}/2$	$V_{CC}/2$	$V_{CC}/2$
V_{mo}	0.3V	0.15V	0.15V	0.10V	0.10V	0.10V

Tape and Reel Specification (Continued)

REEL DIMENSIONS inches (millimeters)



Tape Size	A	B	C	D	N	W1	W2	W3
8 mm	7.0 (177.8)	0.059 (1.50)	0.512 (13.00)	0.795 (20.20)	2.165 (55.00)	$0.331 + 0.059/-0.000$ ($8.40 + 1.50/-0.00$)	0.567 (14.40)	$W1 + 0.078/-0.039$ ($W1 + 2.00/-1.00$)

Physical Dimensions inches (millimeters) unless otherwise noted

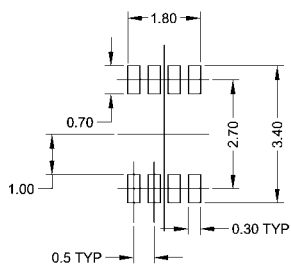
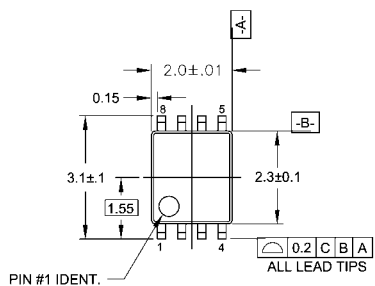

LAND PATTERN RECOMMENDATION

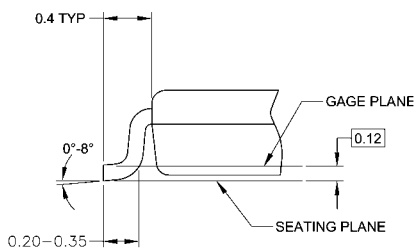
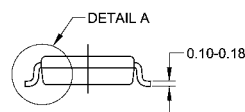
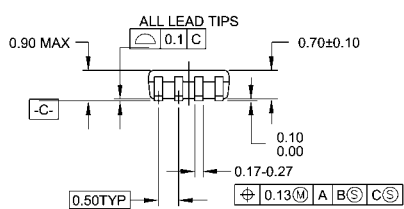

DETAIL A

NOTES:

- A. CONFORMS TO JEDEC REGISTRATION MO-187
- B. DIMENSIONS ARE IN MILLIMETERS.
- C. DIMENSIONS ARE EXCLUSIVE OF BURRS, MOLD FLASH, AND TIE BAR EXTRUSIONS.
- D. DIMENSIONS AND TOLERANCES PER ANSI Y14.5M, 1982.

MAB08AREVC

**8-Lead US8, JEDEC MO-187, Variation CA 3.1mm Wide
Package Number MAB08A**

Physical Dimensions inches (millimeters) unless otherwise noted (Continued)

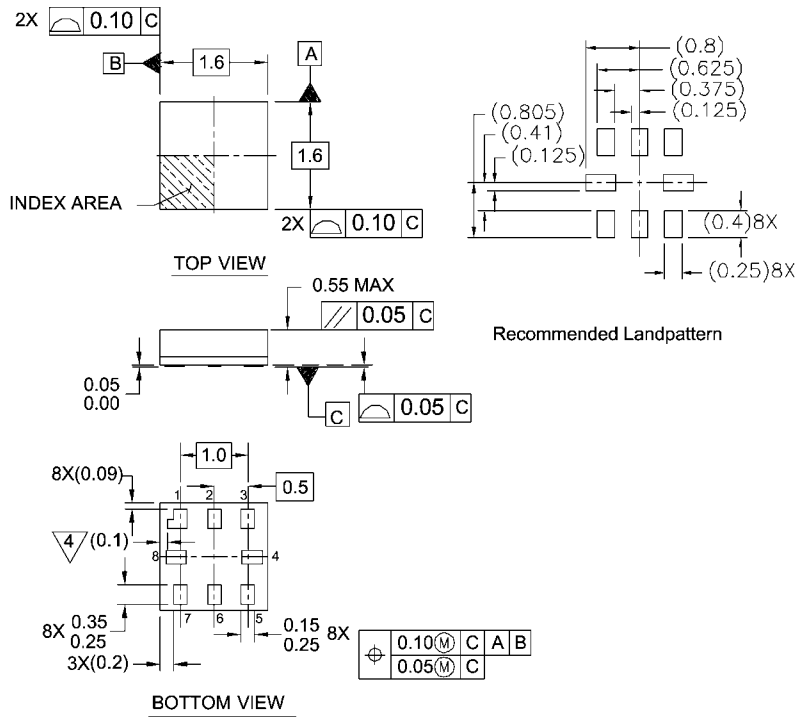

Notes:

1. PACKAGE CONFORMS TO JEDEC MO-255 VARIATION UAAD
2. DIMENSIONS ARE IN MILLIMETERS
3. DRAWING CONFORMS TO ASME Y.14M-1994
4. PIN 1 FLAG, END OF PACKAGE OFFSET.

MAC08AREVC

**Pb-Free 8-Lead MicroPak, 1.6 mm Wide
Package Number MAC08A**

Fairchild does not assume any responsibility for use of any circuitry described, no circuit patent licenses are implied and Fairchild reserves the right at any time without notice to change said circuitry and specifications.

LIFE SUPPORT POLICY

FAIRCHILD'S PRODUCTS ARE NOT AUTHORIZED FOR USE AS CRITICAL COMPONENTS IN LIFE SUPPORT DEVICES OR SYSTEMS WITHOUT THE EXPRESS WRITTEN APPROVAL OF THE PRESIDENT OF FAIRCHILD SEMICONDUCTOR CORPORATION. As used herein:

1. Life support devices or systems are devices or systems which, (a) are intended for surgical implant into the body, or (b) support or sustain life, and (c) whose failure to perform when properly used in accordance with instructions for use provided in the labeling, can be reasonably expected to result in a significant injury to the user.
2. A critical component in any component of a life support device or system whose failure to perform can be reasonably expected to cause the failure of the life support device or system, or to affect its safety or effectiveness.

www.fairchildsemi.com

Looking for pricing, stock, or lifecycle information?

Click below to explore more details on WIN SOURCE:

-  [View NC7WP240L8X on WIN SOURCE](#)
-  [Fairchild/ON Semiconductor Information](#)

Optimize Your Supply Chain with WIN SOURCE Solutions

-  Global Sourcing Solution
-  Obsolete Management
-  Cost Control Management
-  Shortage Management
-  Alternative Solution
-  Excess Inventory Management