



# NCP1501

## Dual Mode PWM/Linear Buck Converter

The NCP1501 is a dual mode regulator that operates either as a PWM Buck Converter or as a Low Drop Out Linear Regulator. If a synchronization signal is present, the NCP1501 operates as a current mode PWM converter with synchronous rectification. The synchronization signal allows the user to control the location of the spurious frequency noise generated by a PWM converter. Linear mode is active when a synchronization signal is not present. The NCP1501 configuration allows an efficient high power operation and low noise during system sleep modes.

### Features

- Synchronous Rectification for Higher Efficiency in PWM Mode
- Linear Mode Operation for Low Noise Output at Low Loads
- Integrated MOSFETs and Feedback Circuits
- Cycle-by-Cycle Peak Current Limit of 800 mA (typ)
- Automatic Switching Between PWM and Linear Mode
- Operating Frequency Range of 500 to 1000 kHz
- Optimized for Ceramic Capacitors and Low Profile Inductors
- Thermal Limit Protection
- Built-in Slope Compensation for Current Mode PWM Converter
- Fixed Output Voltages of 1.05 V, 1.35 V, 1.57 V, 1.8 V
- Shutdown Current Consumption of 0.2  $\mu$ A
- Internal Soft Start
- Transistor Count: 3500
- Pb-Free Package is Available

### Typical Applications

- Cellular Phones
- PDAs
- Pagers
- Supplies for DSP Cores
- Portable Applications

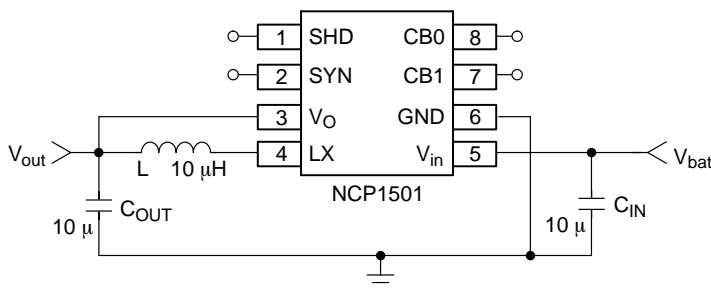

Figure 1. Typical Applications Circuit



ON Semiconductor®

<http://onsemi.com>

### MARKING DIAGRAM



1501 = Device Code  
 A = Assembly Location  
 Y = Year  
 W = Work Week

### PIN CONNECTIONS

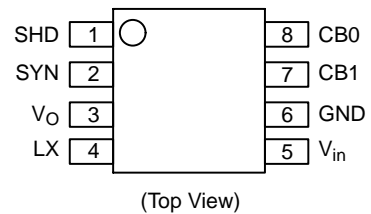

### ORDERING INFORMATION

| Device       | Package          | Shipping†        |
|--------------|------------------|------------------|
| NCP1501DMR2  | Micro8           | 4000/Tape & Reel |
| NCP1501DMR2G | Micro8 (Pb-Free) | 4000/Tape & Reel |

†For information on tape and reel specifications, including part orientation and tape sizes, please refer to our Tape and Reel Packaging Specifications Brochure, BRD8011/D.

# NCP1501

## PIN FUNCTION DESCRIPTIONS

| Pin # | Symbol          | Pin Description  |
|-------|-----------------|--|
| 1     | SHD             | Enable Pin for the NCP1501. This pin is active high. Internal pull down resistor forces the part off if the pin is not connected on the board.   |
| 2     | SYN             | External Synchronization Signal Pin. The device will operate in PWM mode if a clock signal is present. The pin must be pulled low to enter LDO mode. Internal pull down resistor on pin. |
| 3     | V <sub>O</sub>  | Feedback for the NCP1501. An internal MOSFET is connected across V <sub>O</sub> and LX for LDO mode.   |
| 4     | LX              | Connection for the pass devices to the inductor.   |
| 5     | V <sub>in</sub> | Input voltage to the NCP1501.  |
| 6     | GND             | Ground Connection for the device.  |
| 7     | CB1             | Voltage Selection Bit. Internal pull up resistor on pin.   |
| 8     | CB0             | Voltage Selection Bit. Internal pull down resistor on pin.   |

## MAXIMUM RATINGS

| Rating                               | Symbol           | Value   | Unit |
|--------------------------------------|------------------|---|------|
| Maximum Voltage All Pins             | V <sub>max</sub> | 5.5   | V    |
| Maximum operating Voltage All Pins   | V <sub>max</sub> | 5.2   | V    |
| Thermal Resistance, Junction-to-Air  | R <sub>θJA</sub> | 240   | °C/W |
| Operating Ambient Temperature Range  | T <sub>A</sub>   | -30 to +85  | °C   |
| ESD Withstand Voltage                | V <sub>ESD</sub> | > 2500<br>> 100                                     | V    |
|                                      |                  | Human Body Model (Note 1)<br>Machine Model (Note 2) |      |
| Moisture Sensitivity                 | MSL              | Level 1   |      |
| Storage Temperature Range            | T <sub>stg</sub> | -55 to +150   | °C   |
| Junction Operating Temperature Range | T <sub>J</sub>   | -30 to +125   | °C   |

Maximum ratings are those values beyond which device damage can occur. Maximum ratings applied to the device are individual stress limit values (not normal operating conditions) and are not valid simultaneously. If these limits are exceeded, device functional operation is not implied, damage may occur and reliability may be affected.

1. Tested to EIA/JESD22-A114-A
2. Tested to EIA/JESD22-A115-A

**ELECTRICAL CHARACTERISTICS** (V<sub>in</sub> = 3.6 V, V<sub>O</sub> = 1.57 V, T<sub>A</sub> = 25°C, F<sub>syn</sub> = 600 kHz 50% Duty Cycle square wave for PWM mode; T<sub>A</sub> = -30 to 85°C for Min/Max values, unless otherwise noted.)

| Characteristic | Symbol | Min | Typ | Max | Unit |
|----------------|--------|-----|-----|-----|------|
|----------------|--------|-----|-----|-----|------|

### V<sub>CC</sub> Pin

|  |                    |     |     |     |    |
|--|--------------------|-----|-----|-----|----|
| Quiescent Current of Switching Mode, I <sub>out</sub> = 0 mA | I <sub>q</sub> PWM | -   | 124 | 500 | μA |
| Quiescent Current of LDO Mode, I <sub>out</sub> = 0 mA       | I <sub>q</sub> LDO | -   | 32  | 65  | μA |
| Quiescent Current, SHD Low                                   | I <sub>q</sub> Off | -   | 0.2 | 1.0 | μA |
| Input Voltage Range  | V <sub>in</sub>    | 2.7 | -   | 5.2 | V  |

### Sync Pin

|   |                         |      |       |                      |     |
|---|-------------------------|------|-------|----------------------|-----|
| Input Voltage                                     | V <sub>sync</sub>       | -0.3 | -     | V <sub>CC</sub> +0.3 | V   |
| Frequency Operational Range                       | F <sub>sync</sub>       | 500  | -     | 1000                 | kHz |
| Minimum Synchronization Pulse Width               | DC <sub>sync(min)</sub> | -    | 30    | -                    | %   |
| Maximum Synchronization Pulse Width               | DC <sub>sync(max)</sub> | -    | 70    | -                    | %   |
| SYNC "H" Voltage Threshold                        | V <sub>sync(H)</sub>    | -    | 920   | 1200                 | mV  |
| SYNC "L" Voltage Threshold                        | V <sub>sync(L)</sub>    | 400  | 830   | -                    | mV  |
| SYNC "H" Input Current, V <sub>sync</sub> = 3.6 V | I <sub>sync(H)</sub>    | -    | 1.8   | -                    | μA  |
| SYNC "L" Input Current, V <sub>sync</sub> = 0 V   | I <sub>sync(L)</sub>    | -0.5 | 0.005 | -                    | μA  |

# NCP1501

**ELECTRICAL CHARACTERISTICS (continued)** ( $V_{in} = 3.6\text{ V}$ ,  $V_O = 1.57\text{ V}$ ,  $T_A = 25^\circ\text{C}$ ,  $F_{syn} = 600\text{ kHz}$  50% Duty Cycle square wave for PWM mode;  $T_A = -30$  to  $85^\circ\text{C}$  for Min/Max values, unless otherwise noted.)

| Characteristic | Symbol | Min | Typ | Max | Unit |
|----------------|--------|-----|-----|-----|------|
|----------------|--------|-----|-----|-----|------|

## Output Level Selection Pins

|   |             |      |     |              |               |
|---|-------------|------|-----|--------------|---------------|
| Input Voltage                                 | $V_{CB}$    | -0.3 | -   | $V_{CC}+0.3$ | V             |
| CB0,1 "H" Voltage Threshold                   | $V_{CB(H)}$ | -    | 910 | 1200         | mV            |
| CB0,1 "L" Voltage Threshold                   | $V_{CB(L)}$ | 400  | 850 | -            | mV            |
| CB0,1 "H" Input Current, $CBx = 3.6\text{ V}$ | $I_{CB(H)}$ | -    | 1.8 | -            | $\mu\text{A}$ |
| CB0,1 "L" Input Current, $CBx = 0\text{ V}$   | $I_{CB(L)}$ | -0.5 | 0   | -            | $\mu\text{A}$ |

## Shutdown Pin

|   |              |      |     |              |               |
|---|--------------|------|-----|--------------|---------------|
| Input Voltage                               | $V_{SHD}$    | -0.3 | -   | $V_{CC}+0.3$ | V             |
| SHD "H" Voltage Threshold                   | $V_{SHD(H)}$ | -    | 920 | 1200         | mV            |
| SHD "L" Voltage Threshold                   | $V_{SHD(L)}$ | 400  | 850 | -            | mV            |
| SHD "H" Input Current, $SHD = 3.6\text{ V}$ | $I_{SHD(H)}$ | -    | 1.8 | -            | $\mu\text{A}$ |
| SHD "L" Input Current, $SHD = 0\text{ V}$   | $I_{SHD(L)}$ | -0.5 | 0   | -            | $\mu\text{A}$ |

## Feedback Pin

|  |          |      |     |              |               |
|--|----------|------|-----|--------------|---------------|
| Input Voltage                          | $V_{fb}$ | -0.3 | -   | $V_{CC}+0.3$ | V             |
| Input Current, $V_{fb} = 1.8\text{ V}$ | $I_{fb}$ | -    | 8.5 | -            | $\mu\text{A}$ |

## PWM Mode Characteristics

|   |               |                                  |                                  |                                  |                  |
|---|---------------|----------------------------------|----------------------------------|----------------------------------|------------------|
| Switching P-FET Current Limit   | $I_{lim}$     | -                                | 800                              | -                                | mA               |
| Duty Cycle  | DC            | -                                | -                                | 100                              | %                |
| Minimum On Time   | $T_{on(min)}$ | -                                | 100                              | -                                | nsec             |
| $R_{DS(on)}$ Switching<br>N-FET<br>P-FET  | $R_{DS(on)}$  | -<br>-                           | 0.7<br>0.6                       | -<br>-                           | Ohms             |
| Switching P-FET and N-FET Leakage Current   | $I_{leak}$    | -                                | 0.01                             | 10                               | $\mu\text{A}$    |
| Output Over Voltage Threshold   | $V_O$         | -                                | 3.0                              | -                                | %                |
| Output Voltage Accuracy, $V_{out(set)} = 1.05\text{ V}$ $CB0 = L$ , $CB1 = L$<br>$V_{out(set)} = 1.35\text{ V}$ $CB0 = L$ , $CB1 = H$<br>$V_{out(set)} = 1.57\text{ V}$ $CB0 = H$ , $CB1 = H$<br>$V_{out(set)} = 1.80\text{ V}$ $CB0 = H$ $CB1 = L$ | $V_{out}$     | 1.018<br>1.309<br>1.523<br>1.740 | 1.050<br>1.350<br>1.570<br>1.800 | 1.082<br>1.391<br>1.617<br>1.860 | V                |
| Load Transient Response, 10 to 100 mA Load Step   | $V_{out}$     | -                                | 40                               | -                                | mV               |
| Line Transient Response, $I_{out} = 100\text{ mA}$ , 3.0 to 3.6 $V_{in}$ Line Step  | $V_{out}$     | -                                | $\pm 5$                          | -                                | mV <sub>pp</sub> |

## LDO Mode Characteristics

|   |                    |                                  |                                  |                                  |      |
|---|--------------------|----------------------------------|----------------------------------|----------------------------------|------|
| $R_{DS(on)}$ LDO FET (Inductor Switch), LX to $V_{out}$   | $R_{DS(on)}$       | -                                | 7.0                              | -                                | Ohms |
| Dropout Voltage (Limited by $V_{in(min)} = 2.5\text{ V}$ and $V_{out(max)} = 1.8\text{ V}$ )  | $V_{in} - V_{out}$ | -                                | 0.7                              | -                                | V    |
| Output Voltage Accuracy, $V_{out(set)} = 1.05\text{ V}$ $CB0 = L$ , $CB1 = L$<br>$V_{out(set)} = 1.35\text{ V}$ $CB0 = L$ , $CB1 = H$<br>$V_{out(set)} = 1.57\text{ V}$ $CB0 = H$ , $CB1 = H$<br>$V_{out(set)} = 1.80\text{ V}$ $CB0 = H$ $CB1 = L$ | $V_{out}$          | 1.018<br>1.309<br>1.523<br>1.740 | 1.050<br>1.350<br>1.570<br>1.800 | 1.082<br>1.391<br>1.617<br>1.860 | V    |

## Thermal Shutdown

|                  |                    |   |     |   |                  |
|------------------|--------------------|---|-----|---|------------------|
| Thermal Shutdown | TSD                | - | 160 | - | $^\circ\text{C}$ |
| Hysteresis       | TSD <sub>hys</sub> | - | 25  | - | $^\circ\text{C}$ |

# NCP1501

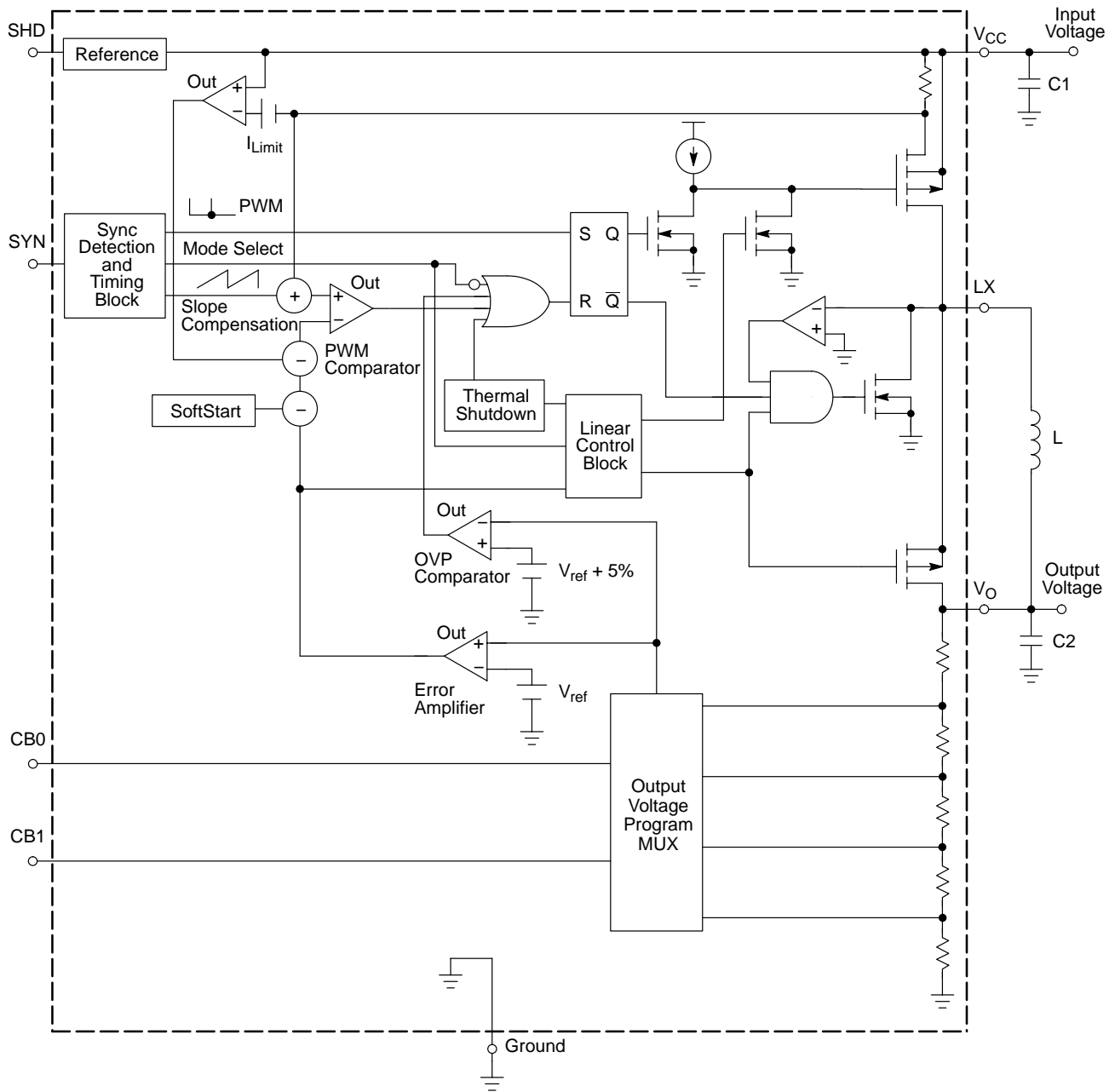

| Component | Value             | Manufacturer  |
|-----------|-------------------|---|
| C1, C2    | 10 $\mu$ F, 6.3 V | TDK, C2012X5R0J106M (0805 size)   |
| L         | 10 $\mu$ H        | TDK, LLF4017-100 ( $I_{out} = 300$ mA)<br>Coilcraft, LPO4812-103MX ( $I_{out} = 300$ mA)<br>Coilcraft, 0805PS-103M ( $I_{out} = 150$ mA)<br>TDK, NLC252018T-100 ( $I_{out} = 100$ mA) |

**Figure 2. Typical Circuit with the Internal Schematic**

# NCP1501

## DETAILED OPERATING DESCRIPTION

The Buck regulator is a synchronous rectifier PWM regulator with integrated MOSFETs. This regulator has an LDO function for low power modes to conserve power and lower ripple voltage associated with PFM mode. The NCP1501 does not contain an internal oscillator for the switching mode. The Dual PWM/LDO mode is an exclusive Patent Pending circuit.

The PWM clock is generated via an external clock signal on the Synchronization pin. The operating frequency range for the PWM is 500 kHz to 1000 kHz. The output current of the PWM is typically 100 mA with a guarantee of over 300 mA for the 2.7 to 5.2 input voltage range.

If a synchronization pulse is not present, the NCP1501 changes into the LDO mode. The LDO function assures the user of an extremely low output ripple voltage and greatly reduced quiescent current when the users system is in a sleep mode. Internally to the NCP1501, the Synchronization pin

has a pull down resistor to force the part into LDO mode when a clock signal is not present. To place the NCP1501 in LDO mode, the user must set the Synchronization pin low. The LDO mode guarantees an output in excess of 50 mA.

Pins CB0 and CB1 control the output voltage selection. The four voltages are 1.05 V, 1.35 V, 1.57 V, 1.8 V. CB0 contains a pull down resistor and CB1 contains a pull up resistor internal to the NCP1501. The resistors force the output of the converter to 1.35 V if the pins are floating connections to the external circuit.

The Shutdown Pin enables the operation of the device. The Shutdown Pin has an internal pull down resistor to force the NCP1501 into the off mode if this pin is floating due to the external circuit. During Startup, the NCP1501 has a soft start function to limit fast  $dV/dt$  and eliminate overshoot on the output.

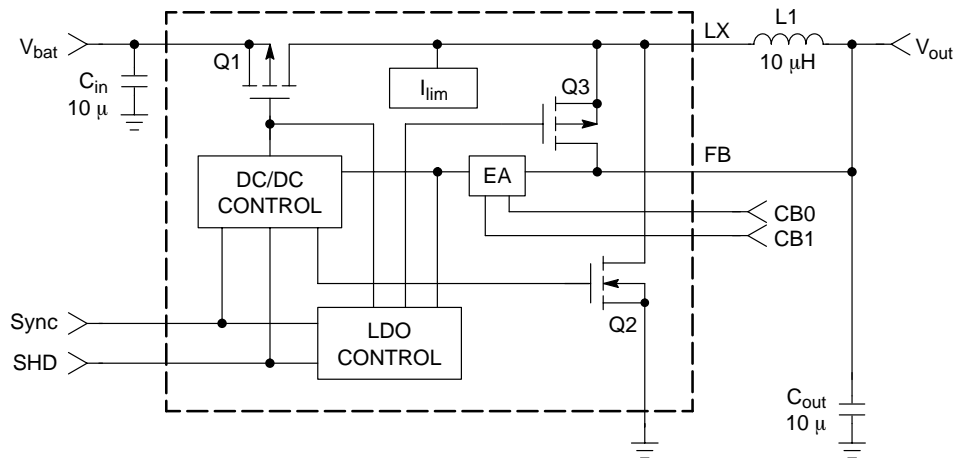

Figure 3. Block Diagram and Circuit Schematic of the NCP1501

The external components required are an input and an output 10 0 μF ceramic capacitor and a 10 μH inductor.

### PWM Mode

During normal operation, a synchronization pulse acts as the clock for the DC/DC controller. The rising edge of the clock pulls the gate of Q1 low allowing the inductor to charge. When the current through Q1 reaches either the current limit or feedback voltage reaches its limit, Q1 will turn off and Q2 will turn on. Q2 replaces the free wheeling diode typically associated with Buck Converters. Q2 will turn off when either a rising edge sync pulse is present or all the stored energy is depleted from the inductor. Q3 remains off during this mode.

The output voltage accuracy in the PWM mode is well within 3% of the nominal set value. An over voltage protection circuit is present in the PWM mode to limit the positive voltage spike due to fast load transient conditions. The PWM also has the ability to go to 100% duty cycle for transient conditions and low input to output voltage differentials.

In PWM mode, each switching cycle has a guaranteed on-time of 100 ns. The NCP1501 has two protection circuits that can eliminate the cycle. When tripped, the over voltage protection or the thermal shutdown overrides the gate drive of the high side MOSFET.

# NCP1501

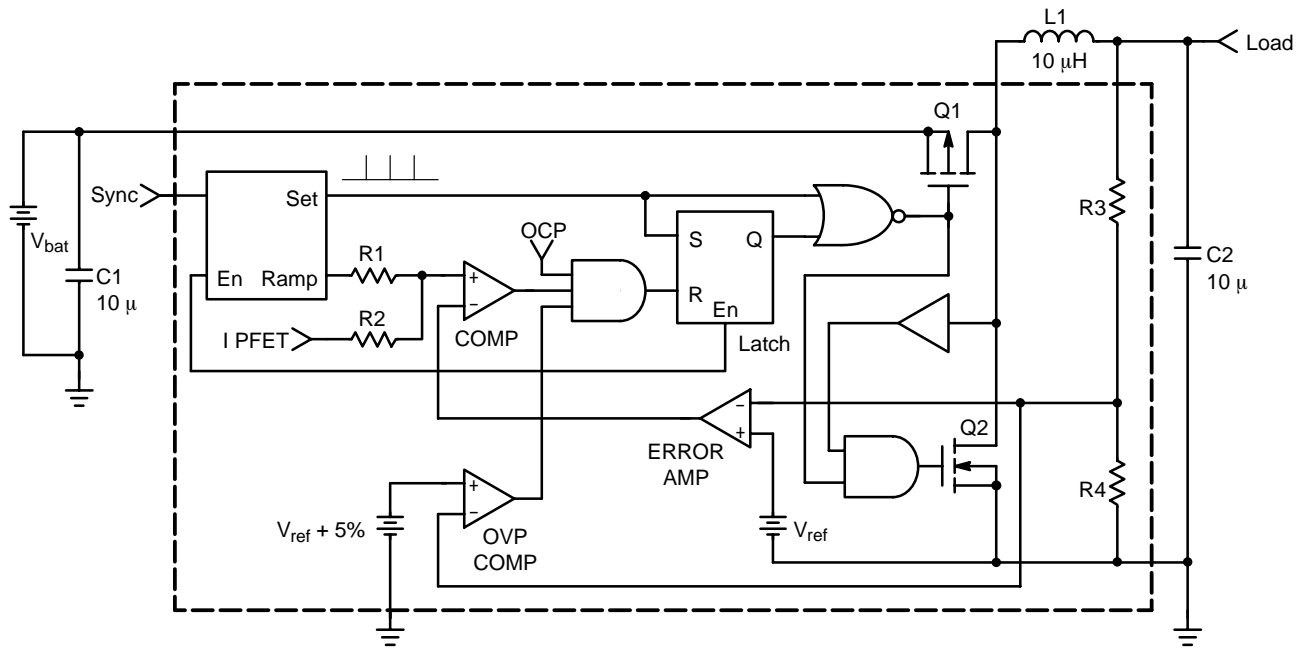

Figure 4. PWM Circuit Schematic

## LDO Mode

When the synchronization pulse is not present, the NCP1501 operates as an LDO. The DC/DC Control Circuitry will relinquish control of Q1 and turn off Q2. The

LDO Control Circuitry will turn on Q3 as a bypass circuit to the inductor. Q1 is the controlling pass device of the LDO that regulates the input to output voltage dropout. The LDO can source an output current in excess of 50 mA.

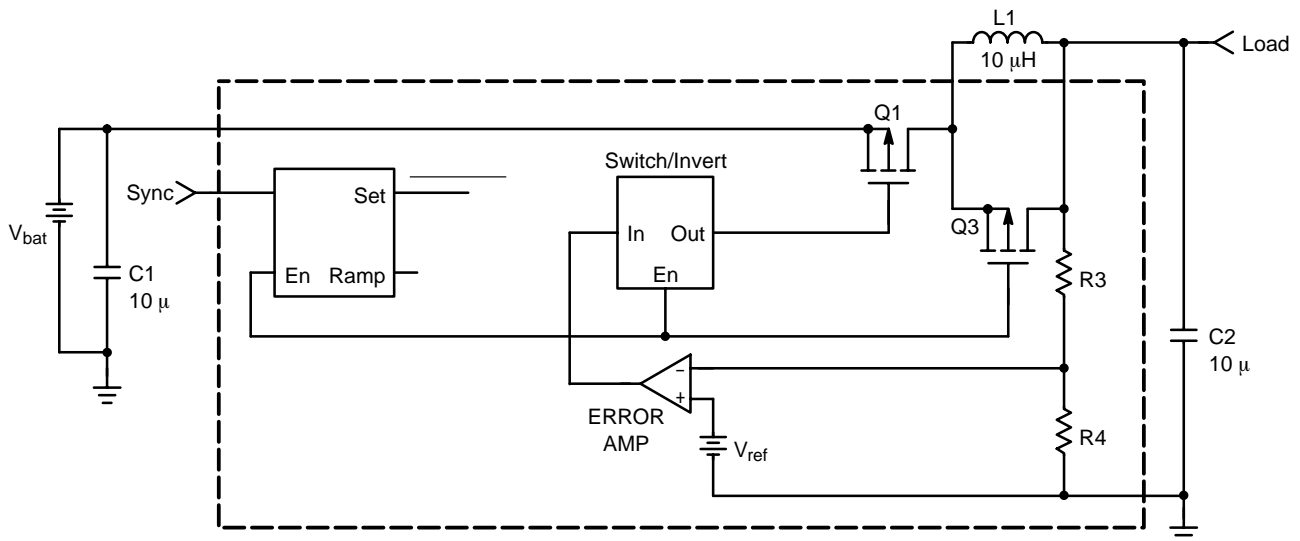

Figure 5. LDO Circuit Schematic

# NCP1501

## Voltage Output Selection

The output voltage selection is accomplished via two external pins: CB0 and CB1. If CB0 and CB1 pins are left floating by the external circuit, the output voltage will default to 1.35 V. The corresponding voltages are as follows.

|     |     | NCP1501              |  |
|-----|-----|----------------------|--|
| CB0 | CB1 | V <sub>out</sub> (V) |  |
| 0   | 0   | 1.05                 |  |
| 0   | 1   | 1.35                 |  |
| 1   | 1   | 1.57                 |  |
| 1   | 0   | 1.80                 |  |

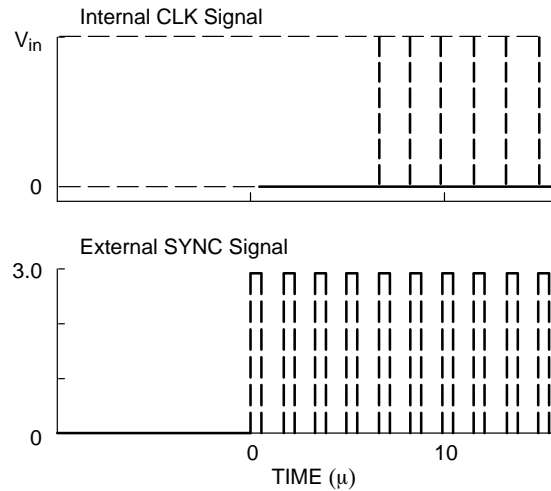

Figure 6. Transition Waveforms from LDO to PWM Mode

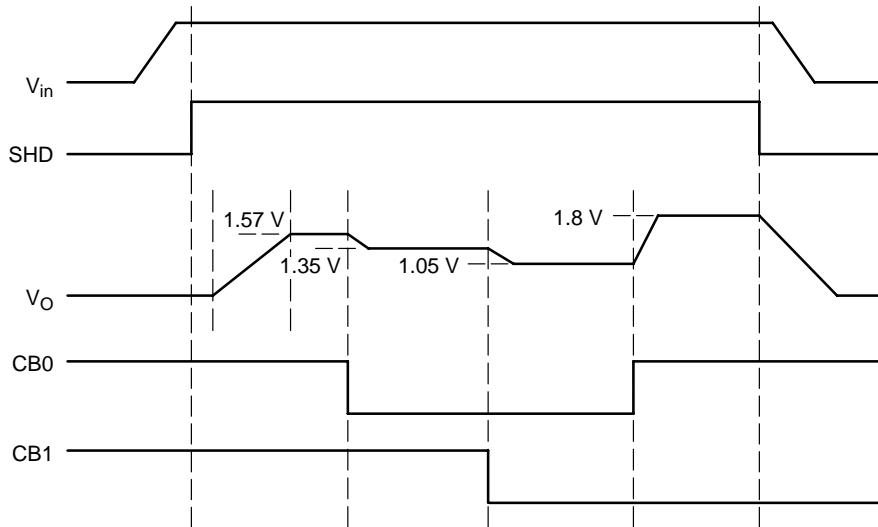

Figure 7. Power Up and Power Down Sequence

## Thermal Shutdown

Internal Thermal Shutdown circuitry is provided to protect the integrated circuit in the event that the maximum junction temperature is exceeded. When activated, typically at 160°C, the PWM latch is reset and the linear regulator control circuitry is disabled. The thermal shutdown circuit is designed with 25°C of hysteresis. This means that the

PWM latch and the regulator control circuitry cannot be re-enabled until the die temperature drops by this amount. This feature is provided to prevent catastrophic failures from accidental device overheating. It is not intended as a substitute for proper heatsinking. The NCP1501 is contained in the Micro-8 package.

# NCP1501

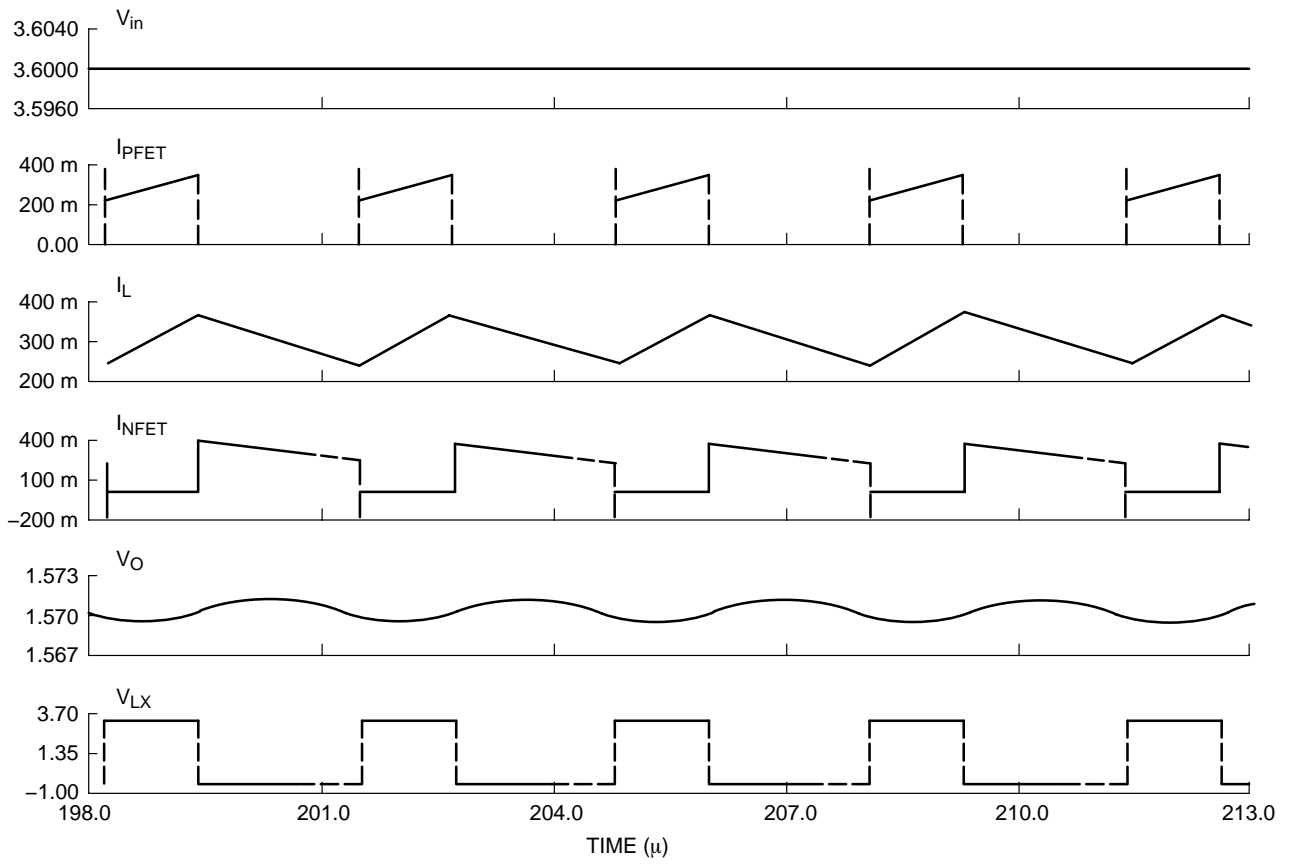

Figure 8. Waveforms During Normal Operation

# NCP1501

## APPLICATIONS INFORMATION

NCP1501 is a dual mode PWM or LDO step down converter. This dual mode takes advantage of the best of each mode. There are three required external components: an input and output capacitor and an inductor.

The PWM mode allows high efficiency for larger loads. A typical efficiency for an input of 3.6 V and an output of 1.8 V and 100 mA is over 90%. Low  $R_{DSon}$  and synchronous rectification contained within the device contributes to the very high efficiency. As with other synchronous rectification devices, the NCP1501 does not require an external diode to supplement the NFET during switching on or off. A synchronization pin allows the user to define the frequency noise spikes of the PWM. The duty cycle of the synchronization signal must be within the range

of 30% to 70%. The rising edge of the signal from the synchronization pin acts as the oscillator signal to set the latch and reset the ramp compensation signal. An Over Voltage Protection circuit ensures the output will respond properly to fast transients from large to small loads. The NCP1501 allows the PWM mode to enter a 100% duty cycle for fast load transient conditions and low input to output voltage differentials.

The LDO mode is effective during low load conditions by lowering the quiescent current and reducing the output ripple voltage associated with PWM converters entering PFM mode. NCP1501 enters the LDO mode when a synchronization signal is not present. It is recommended to pull the synchronization signal low for LDO mode.

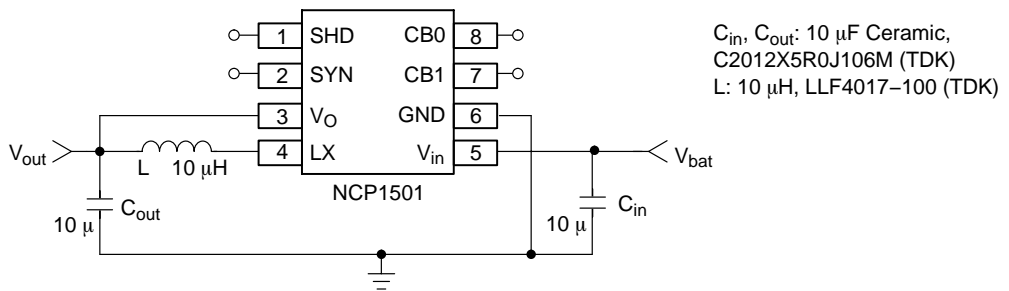

Figure 9. Typical Operating Schematic

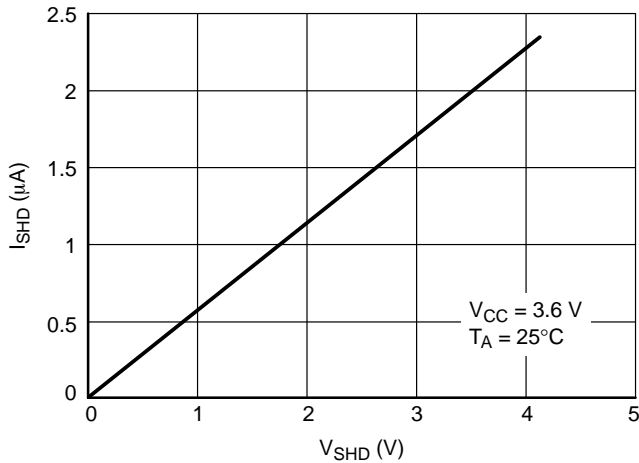

Figure 10. Input Current versus Voltage for the Shutdown Pin

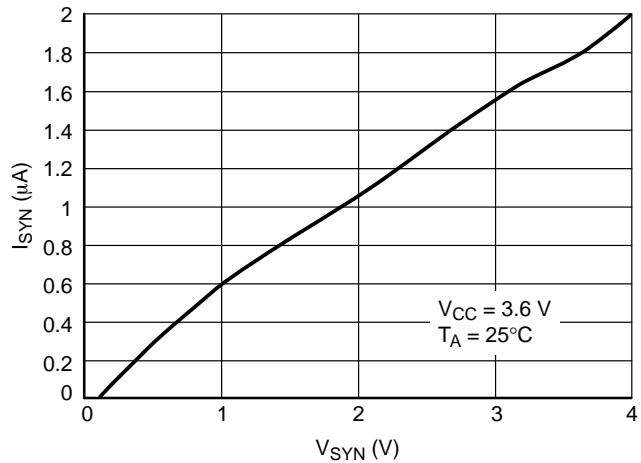

Figure 11. Input Current versus Voltage for the Synchronization Pin

# NCP1501

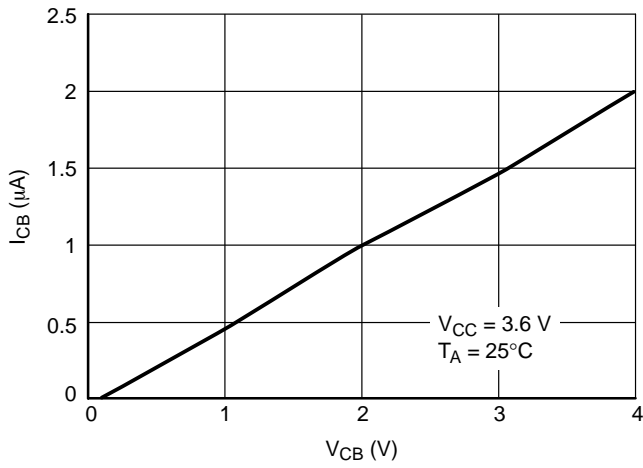

Figure 12. Input Current versus Voltage for the CB Pins

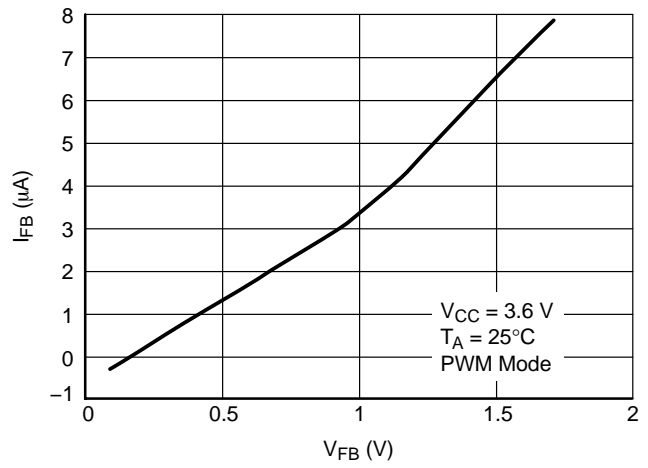

Figure 13. Input Current versus Voltage for the Feedback Pin

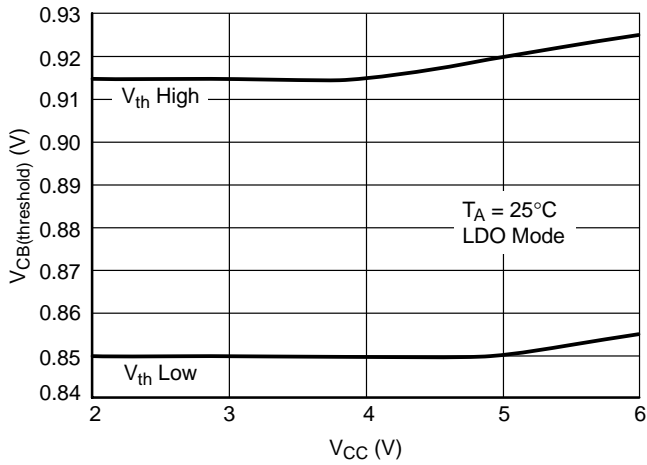

Figure 14. V<sub>CC</sub> Input Voltage versus CB Threshold

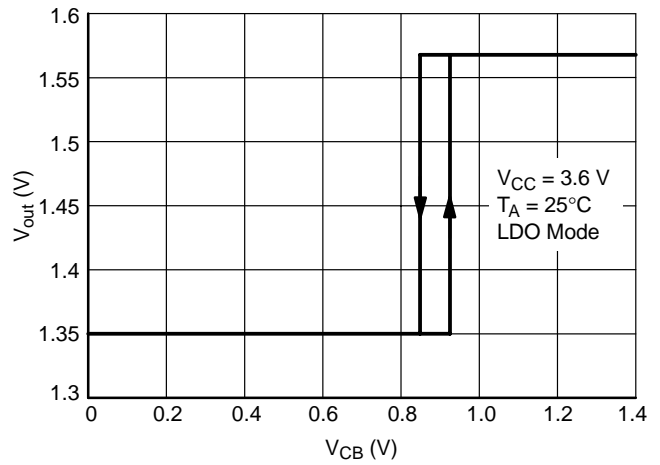

Figure 15. Transition Level of CB Pins

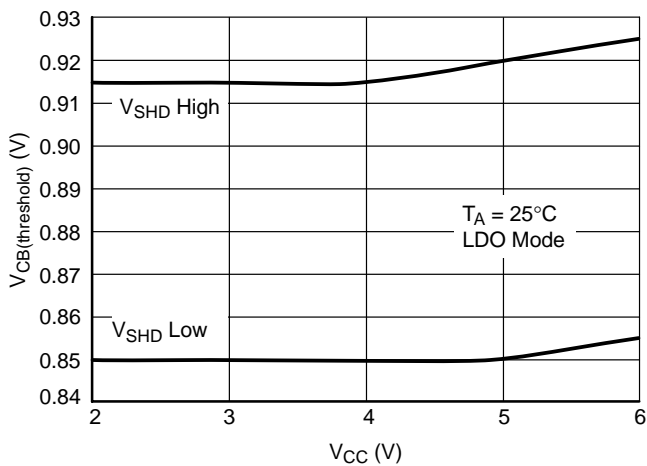

Figure 16. Input Voltage versus Shutdown Voltage

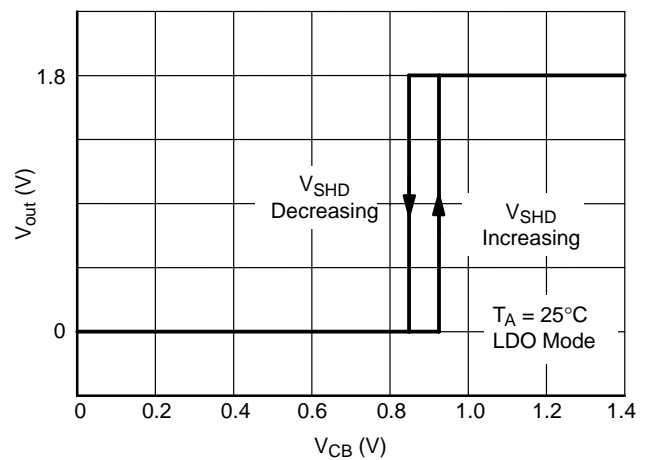

Figure 17. Output Voltage versus Shutdown Pin Voltage

# NCP1501

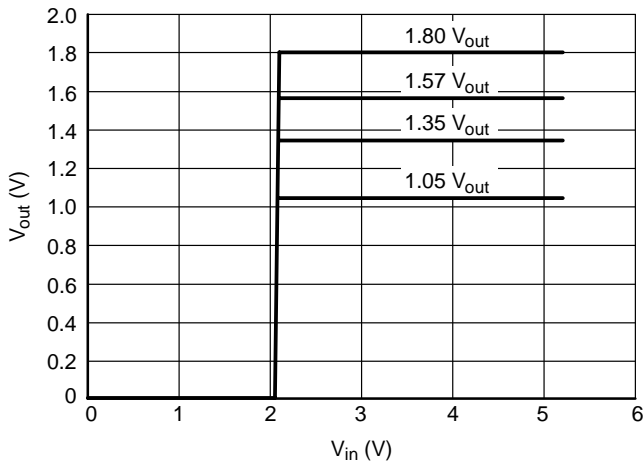

Figure 18. Output Voltage versus PWM Input Voltage

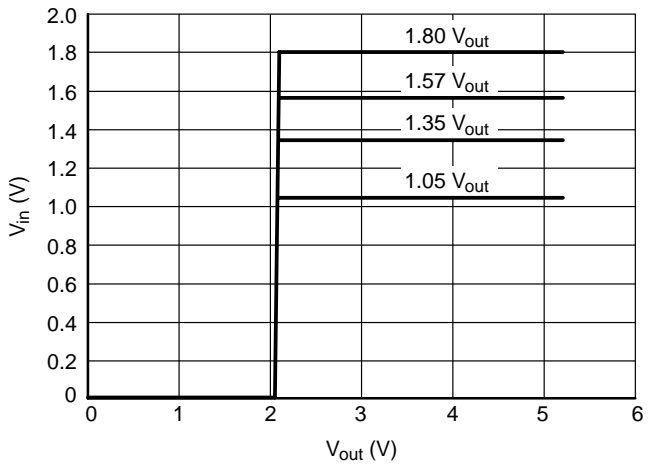

Figure 19. Input Voltage versus Output Voltage

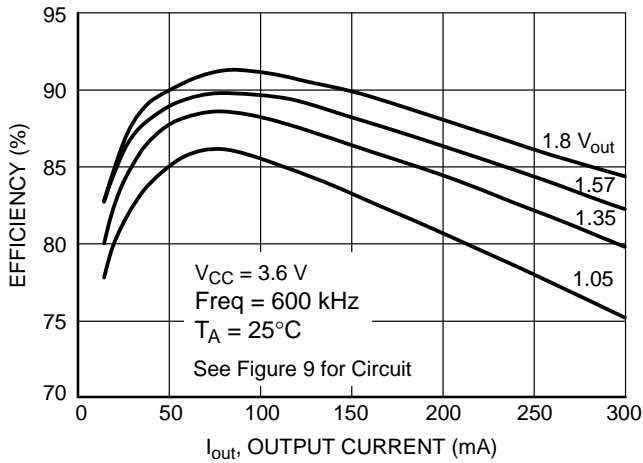

Figure 20. Efficiency versus Output Current

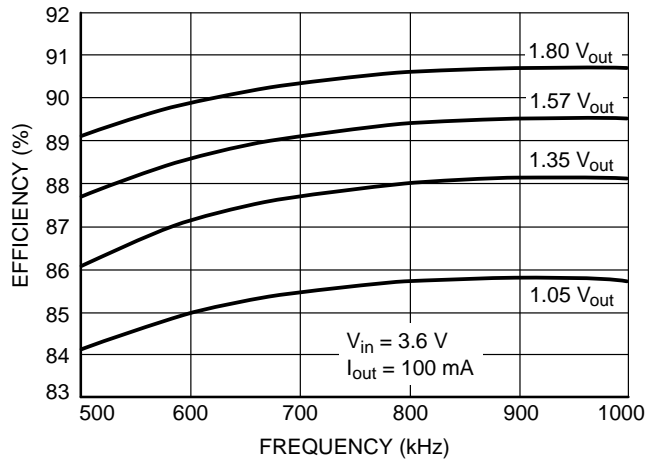

Figure 21. Efficiency versus Frequency

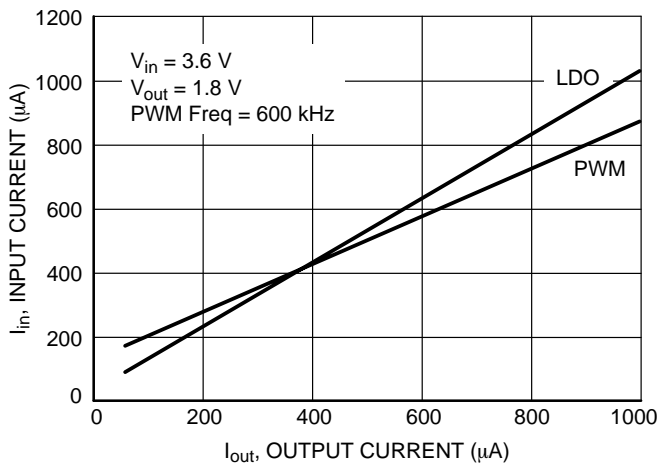

Figure 22. Input Current versus Output Current Comparison for PWM and LDO Mode

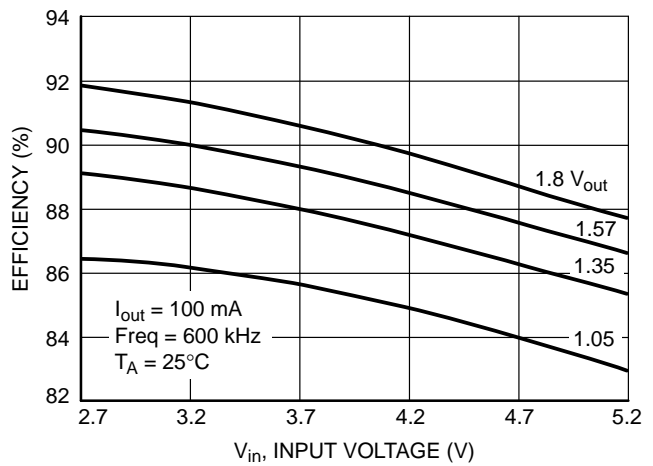

Figure 23. Efficiency versus Input Voltage

# NCP1501

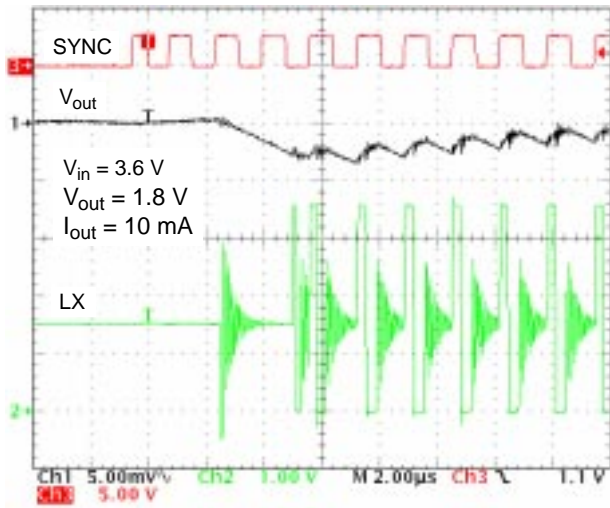

Figure 24. Transition from LDO to PWM Mode

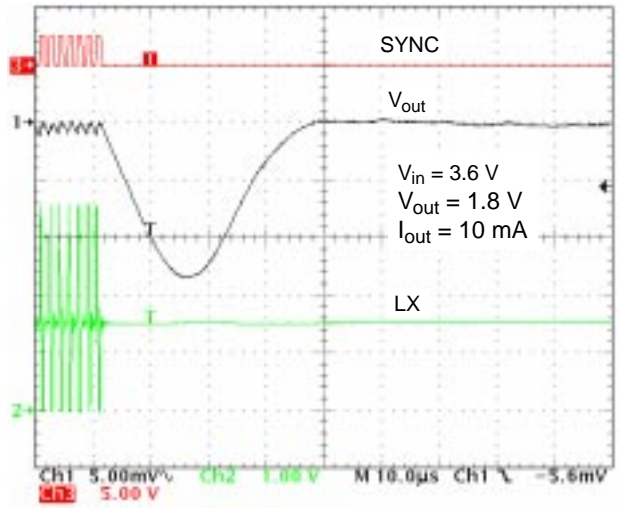

Figure 25. Transition from PWM to LDO Mode

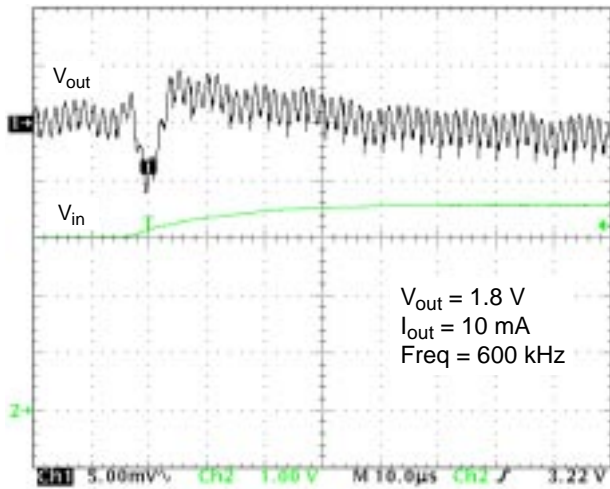

Figure 26. Line Transient from 3.0 to 3.6 V

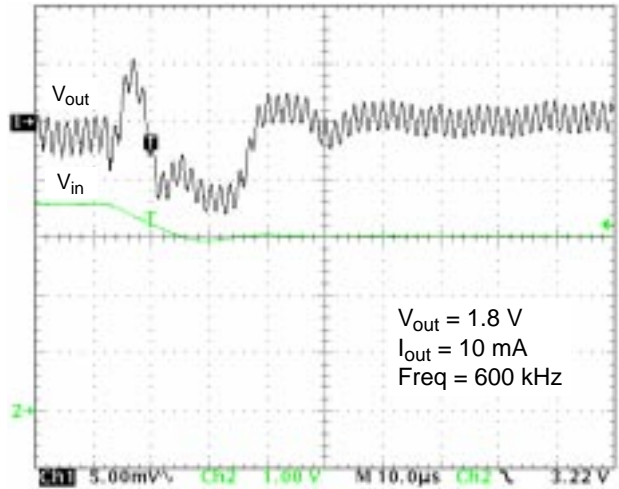

Figure 27. Line Transient from 3.6 to 3.0 V

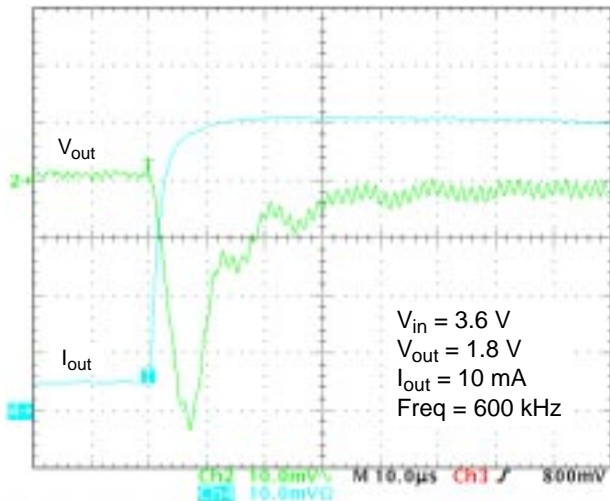

Figure 28. Load Transient from 10 to 100 mA

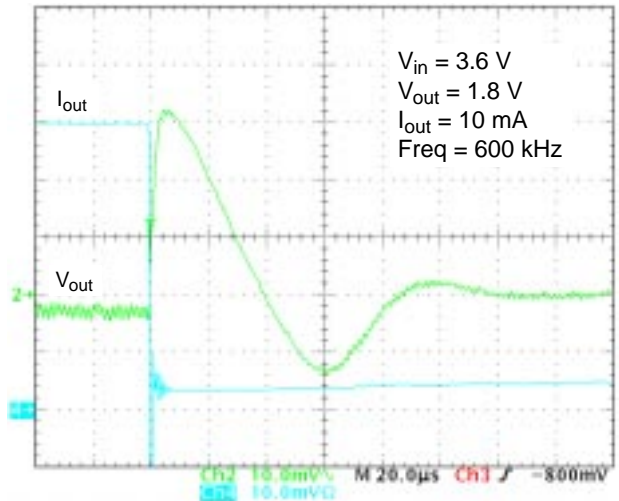

Figure 29. Load Transient from 100 to 10 mA

# NCP1501

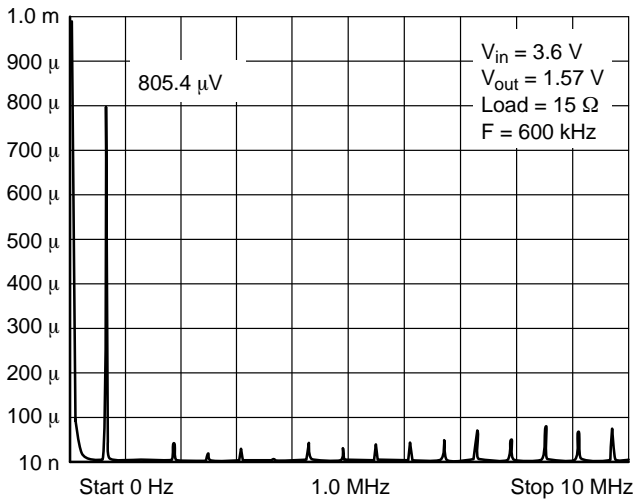

Figure 30.  $V_{rms}$  versus Frequency

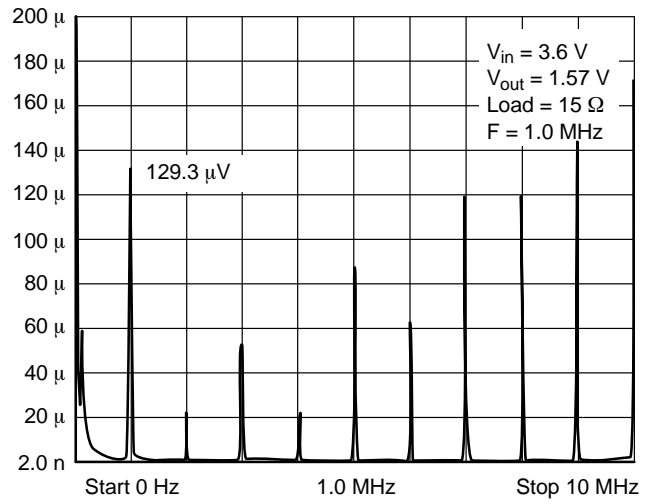

Figure 31.  $V_{rms}$  versus Frequency

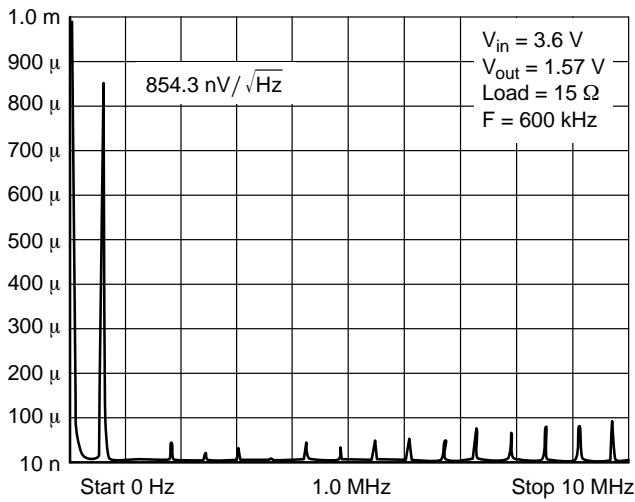

Figure 32. Noise versus Frequency

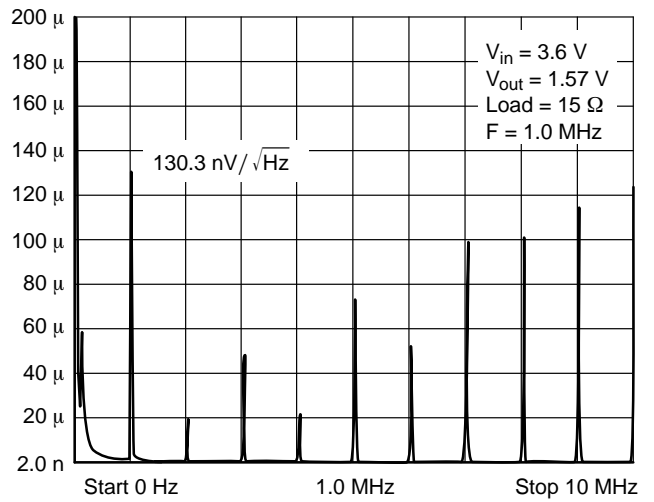
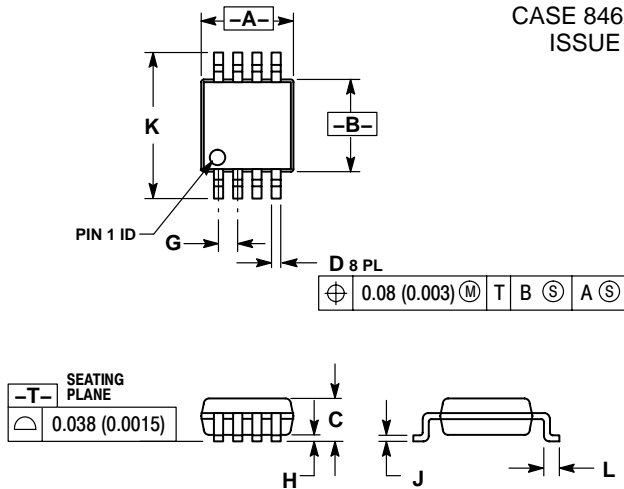

Figure 33.  $V_{RMS}$  versus Frequency

# NCP1501

## PACKAGE DIMENSIONS

**Micro8  
(MSOP-8)  
DM SUFFIX  
CASE 846A-02  
ISSUE F**



### NOTES:

1. DIMENSIONING AND TOLERANCING PER ANSI Y14.5M, 1982.
2. CONTROLLING DIMENSION: MILLIMETER.
3. DIMENSION A DOES NOT INCLUDE MOLD FLASH, PROTRUSIONS OR GATE BURRS. MOLD FLASH, PROTRUSIONS OR GATE BURRS SHALL NOT EXCEED 0.15 (0.006) PER SIDE.
4. DIMENSION B DOES NOT INCLUDE INTERLEAD FLASH OR PROTRUSION. INTERLEAD FLASH OR PROTRUSION SHALL NOT EXCEED 0.25 (0.010) PER SIDE.
5. 846A-01 OBSOLETE, NEW STANDARD 846A-02.

| DIM | MILLIMETERS |      | INCHES    |       |
|-----|-------------|------|-----------|-------|
|     | MIN         | MAX  | MIN       | MAX   |
| A   | 2.90        | 3.10 | 0.114     | 0.122 |
| B   | 2.90        | 3.10 | 0.114     | 0.122 |
| C   | ---         | 1.10 | ---       | 0.043 |
| D   | 0.25        | 0.40 | 0.010     | 0.016 |
| G   | 0.65 BSC    |      | 0.026 BSC |       |
| H   | 0.05        | 0.15 | 0.002     | 0.006 |
| J   | 0.13        | 0.23 | 0.005     | 0.009 |
| K   | 4.75        | 5.05 | 0.187     | 0.199 |
| L   | 0.40        | 0.70 | 0.016     | 0.028 |

### SOLDERING FOOTPRINT\*

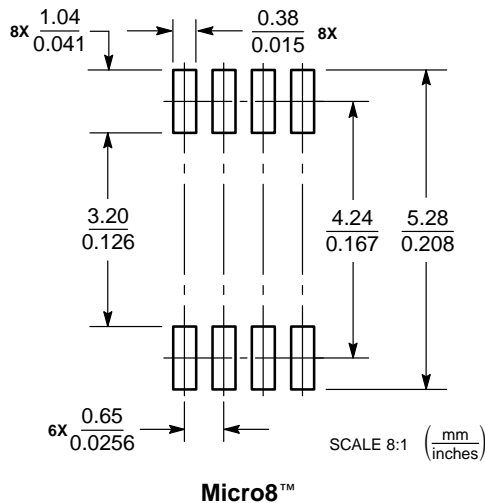

Micro8™

\*For additional information on our Pb-Free strategy and soldering details, please download the ON Semiconductor Soldering and Mounting Techniques Reference Manual, SOLDERRM/D.

Micro8 is a trademark of International Rectifier.

ON Semiconductor and  are registered trademarks of Semiconductor Components Industries, LLC (SCILLC). SCILLC reserves the right to make changes without further notice to any products herein. SCILLC makes no warranty, representation or guarantee regarding the suitability of its products for any particular purpose, nor does SCILLC assume any liability arising out of the application or use of any product or circuit, and specifically disclaims any and all liability, including without limitation special, consequential or incidental damages. "Typical" parameters which may be provided in SCILLC data sheets and/or specifications can and do vary in different applications and actual performance may vary over time. All operating parameters, including "Typicals" must be validated for each customer application by customer's technical experts. SCILLC does not convey any license under its patent rights nor the rights of others. SCILLC products are not designed, intended, or authorized for use as components in systems intended for surgical implant into the body, or other applications intended to support or sustain life, or for any other application in which the failure of the SCILLC product could create a situation where personal injury or death may occur. Should Buyer purchase or use SCILLC products for any such unintended or unauthorized application, Buyer shall indemnify and hold SCILLC and its officers, employees, subsidiaries, affiliates, and distributors harmless against all claims, costs, damages, and expenses, and reasonable attorney fees arising out of, directly or indirectly, any claim of personal injury or death associated with such unintended or unauthorized use, even if such claim alleges that SCILLC was negligent regarding the design or manufacture of the part. SCILLC is an Equal Opportunity/Affirmative Action Employer. This literature is subject to all applicable copyright laws and is not for resale in any manner.

### PUBLICATION ORDERING INFORMATION

**LITERATURE FULFILLMENT:**  
Literature Distribution Center for ON Semiconductor  
P.O. Box 5163, Denver, Colorado 80217 USA  
**Phone:** 303-675-2175 or 800-344-3860 Toll Free USA/Canada  
**Fax:** 303-675-2176 or 800-344-3867 Toll Free USA/Canada  
**Email:** orderlit@onsemi.com

**N. American Technical Support:** 800-282-9855 Toll Free  
USA/Canada

**Japan:** ON Semiconductor, Japan Customer Focus Center  
2-9-1 Kamimeguro, Meguro-ku, Tokyo, Japan 153-0051  
**Phone:** 81-3-5773-3850

**ON Semiconductor Website:** <http://onsemi.com>

**Order Literature:** <http://www.onsemi.com/litorder>

For additional information, please contact your local Sales Representative.

## Looking for pricing, stock, or lifecycle information?

Click below to explore more details on WIN SOURCE:

 [View NCP1501DMR2G on WIN SOURCE](#)

 [ON Semiconductor](#) Information

## Optimize Your Supply Chain with WIN SOURCE Solutions

-  Global Sourcing Solution
-  Obsolete Management
-  Cost Control Management
-  Shortage Management
-  Alternative Solution
-  Excess Inventory Management