



**THE DATASHEET OF
NCP3335AMNADJR2G**



NCP3335A

Ultra High Accuracy, Low Iq, 500 mA Low Dropout Regulator

The NCP3335A is a high performance, low dropout regulator with accuracy of $\pm 0.9\%$ over line and load. This device features ultra-low quiescent current and noise which encompasses all necessary characteristics demanded by today's consumer electronics. This unique device is guaranteed to be stable without a minimum load current requirement and stable with any type of capacitor as small as 1.0 μF . The NCP3335A also comes equipped with sense and noise reduction pins to increase the overall utility of the device and offers reverse bias protection.

Features

- High Accuracy Over Line and Load ($\pm 0.9\%$ at 25°C)
- Ultra-Low Dropout Voltage at Full Load (260 mV typ.)
- No Minimum Output Current Required for Stability
- Low Noise (31 μVrms w/10 nF C_{nr} and 51 μVrms w/out C_{nr})
- Low Shutdown Current (0.07 μA)
- Reverse Bias Protected
- 2.6 V to 12 V Supply Range
- Thermal Shutdown Protection
- Current Limitation
- Requires Only 1.0 μF Output Capacitance for Stability
- Stable with Any Type of Capacitor (including MLCC)
- Available in 1.5 V, 1.8 V, 2.5 V, 2.8 V, 2.85 V, 3.0 V, 3.3 V, 5.0 V and Adjustable Output Voltages
- These are Pb-Free Devices

Applications

- PCMCIA Card
- Cellular Phones
- Camcoders and Cameras
- Networking Systems, DSL/Cable Modems
- Cable Set-Top Box
- MP3/CD Players
- DSP Supply
- Displays and Monitors



ON Semiconductor®

<http://onsemi.com>



Micro8™
DM SUFFIX
CASE 846A



DFN10
MN SUFFIX
CASE 485C

MARKING DIAGRAMS

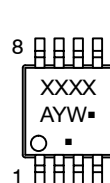

Fixed Version

Pin 1, 2. V_{out}
3. Sense
4. GND
5. NR
6. \overline{SD}
7, 8. V_{in}

Adj Version

Pin 1, 2. V_{out}
3. Adj
4. GND
5. NR
6. \overline{SD}
7, 8. V_{in}

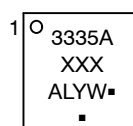

Fixed Version

Pin 1, 2. V_{out}
3. Sense
4. GND
5, 6. NC
7. NR
8. \overline{SD}
9, 10. V_{in}

Adj Version

Pin 1, 2. V_{out}
3. Adj
4. GND
5, 6. NC
7. NR
8. \overline{SD}
9, 10. V_{in}

XXX = Specific Device Marking

A = Assembly Location

L = Wafer Lot

Y = Year

W = Work Week

▪ = Pb-Free Package

(Note: Microdot may be in either location)

ORDERING INFORMATION

See detailed ordering, marking and shipping information in the package dimensions section on page 19 of this data sheet.

NCP3335A

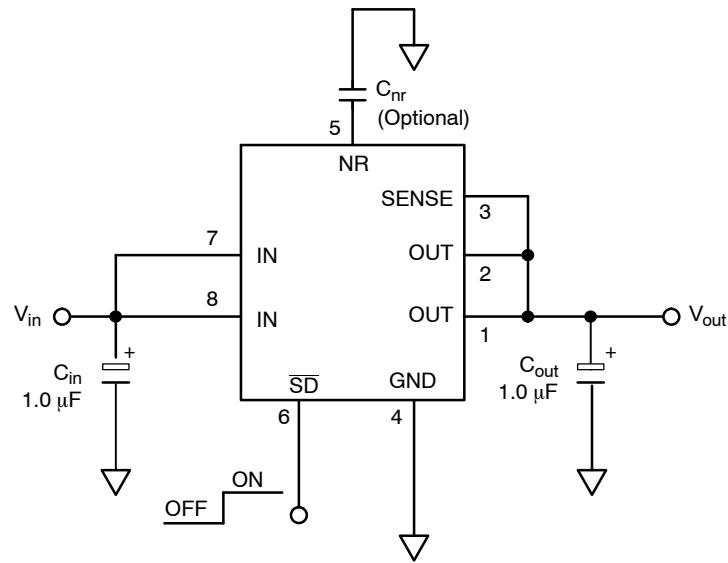

Figure 1. Typical Fixed Version Application Schematic (Micro8 Package)

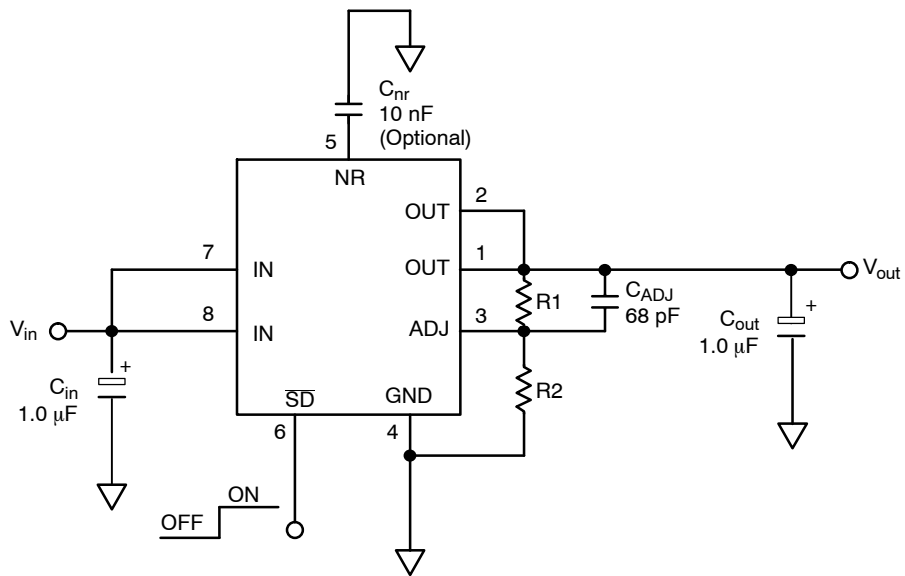

Figure 2. Typical Adjustable Version Application Schematic (Micro8 Package)

NCP3335A

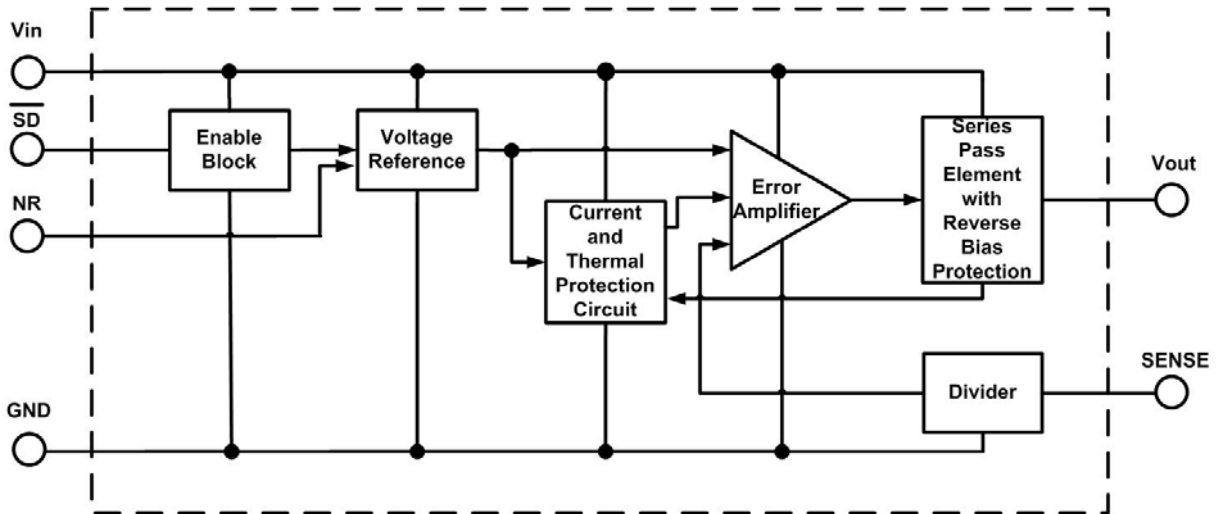

Figure 3. Block Diagram, Fixed Output Version

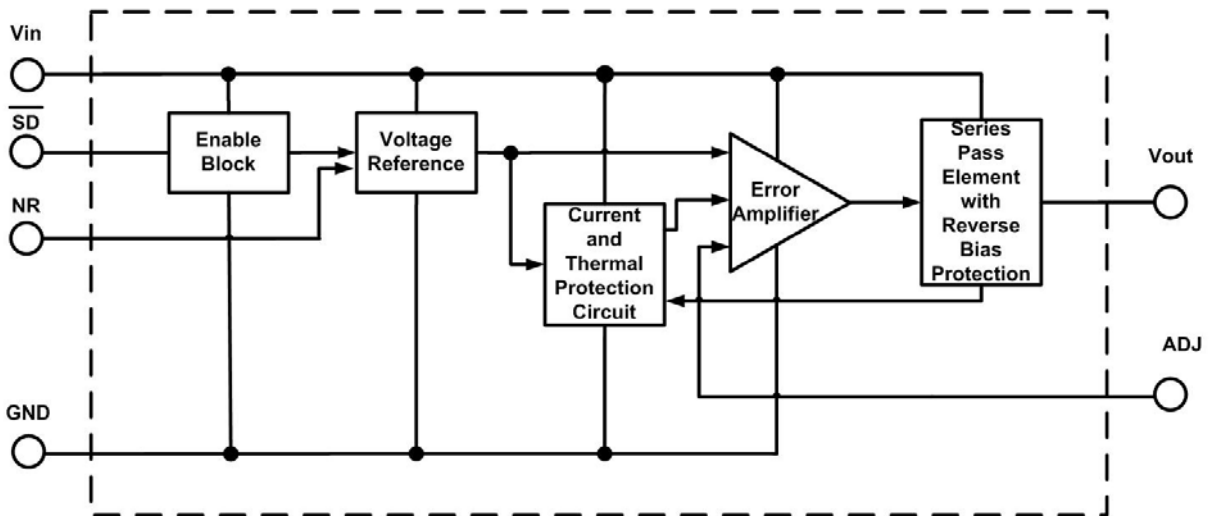

Figure 4. Block Diagram, Adjustable Output Version

NCP3335A

PIN FUNCTION DESCRIPTION

Fixed Version

Micro8 Pin No.	DFN10 Pin No.	Pin Name	Description
1, 2	1, 2	V _{out}	Regulated output voltage. Bypass to ground with C _{out} ≥ 1.0 μF.
3	3	SENSE	For output voltage sensing, connect to Pins 1 and 2.
4	4	GND	Power Supply Ground
5	7	NR	Noise Reduction Pin. This is an optional pin used to further reduce noise.
6	8	SD	Shutdown pin. When not in use, this pin should be connected to the input pin.
7, 8	9, 10	V _{in}	Power Supply Input Voltage
-	5, 6	NC	Not Connected
-	EPAD	EPAD	Exposed thermal pad should be connected to ground.

Adjustable Version

1, 2	1, 2	V _{out}	Regulated output voltage. Bypass to ground with C _{out} ≥ 1.0 μF.
3	3	Adj	Adjustable pin; reference voltage = 1.25 V.
4	4	GND	Power Supply Ground
5	7	NR	Noise Reduction Pin. This is an optional pin used to further reduce noise.
6	8	SD	Shutdown pin. When not in use, this pin should be connected to the input pin.
7, 8	9, 10	V _{in}	Power Supply Input Voltage
-	5, 6	NC	Not Connected
-	EPAD	EPAD	Exposed thermal pad should be connected to ground.

MAXIMUM RATINGS

Rating	Symbol	Value	Unit
Input Voltage	V _{in}	-0.3 to +16	V
Output Voltage	V _{out}	-0.3 to V _{in} +0.3 or 10 V*	V
Shutdown Pin Voltage	V _{sh}	-0.3 to +16	V
Junction Temperature Range	T _J	-40 to +150	°C
Storage Temperature Range	T _{stg}	-50 to +150	°C

Stresses exceeding Maximum Ratings may damage the device. Maximum Ratings are stress ratings only. Functional operation above the Recommended Operating Conditions is not implied. Extended exposure to stresses above the Recommended Operating Conditions may affect device reliability.

NOTE: This device series contains ESD protection and exceeds the following tests:

Human Body Model (HBM) JESD 22-A114-B

Machine Model (MM) JESD 22-A115-A

*Which ever is less. Reverse bias protection feature valid only if V_{out} - V_{in} ≤ 7 V.

THERMAL CHARACTERISTICS

Characteristic	Test Conditions (Typical Value)		Unit
	Min Pad Board (Note 1)	1" Pad Board (Note 1)	
Micro 8			
Junction-to-Air, θ _{JA}	264	174	°C/W
Junction-to-Pin, ψ _{JL2}	110	100	°C/W
10 Lead DFN EPad			
Junction-to-Air, θ _{JA}	215	66	°C/W
Junction-to-Pin, ψ _{JL2}	55	17	°C/W

1. As mounted on a 35 x 35 x 1.5 mm FR4 Substrate, with a single layer of a specified copper area of 2 oz (0.07 mm thick) copper traces and heat spreading area. JEDEC 51 specifications for a low and high conductivity test board recommend a 2 oz copper thickness. Test conditions are under natural convection or zero air flow.

NCP3335A

ELECTRICAL CHARACTERISTICS – 5.0 V ($V_{out} = 5.0$ V typical, $V_{in} = 5.4$ V, $T_A = -40^{\circ}\text{C}$ to $+85^{\circ}\text{C}$, unless otherwise noted, Note 2.)

Characteristic	Symbol	Min	Typ	Max	Unit
Output Voltage (Accuracy) $V_{in} = 5.4$ V to 9.0 V, $I_{load} = 0.1$ mA to 500 mA, $T_A = 25^{\circ}\text{C}$	V_{out}	-0.9% 4.955	5.0	+0.9% 5.045	V
Output Voltage (Accuracy) $V_{in} = 5.4$ V to 9.0 V, $I_{load} = 0.1$ mA to 500 mA, $T_A = 0^{\circ}\text{C}$ to $+85^{\circ}\text{C}$	V_{out}	-1.4% 4.930	5.0	+1.4% 5.070	V
Output Voltage (Accuracy) $V_{in} = 5.4$ V to 9.0 V, $I_{load} = 0.1$ mA to 500 mA, $T_A = -40^{\circ}\text{C}$ to $+125^{\circ}\text{C}$	V_{out}	-1.5% 4.925	5.0	+1.5% 5.075	V
Line Regulation $V_{in} = 5.4$ V to 12 V, $I_{load} = 0.1$ mA	LineReg		0.04		mV/V
Load Regulation $V_{in} = 5.4$ V, $I_{load} = 0.1$ mA to 500 mA	LoadReg		0.04		mV/mA
Dropout Voltage (See App Note) $I_{load} = 500$ mA $I_{load} = 300$ mA $I_{load} = 50$ mA $I_{load} = 0.1$ mA	V_{DO}			340 230 110 10	mV
Peak Output Current (See Figure 16)	I_{pk}	500	700	830	mA
Short Output Current (See Figure 16)	I_{sc}			930	mA
Thermal Shutdown	T_J		160		$^{\circ}\text{C}$
Ground Current In Regulation $I_{load} = 500$ mA (Note 3) $I_{load} = 300$ mA (Note 3) $I_{load} = 50$ mA $I_{load} = 0.1$ mA In Dropout $V_{in} = 4.9$ V, $I_{load} = 0.1$ mA In Shutdown $S_D = 0$ V	I_{GND} I_{GNDsh}		9.0 4.6 0.8 – – 0.07	14 7.5 2.5 190 500 1.0	mA μA
Output Noise $C_{nr} = 0$ nF, $I_{load} = 500$ mA, $f = 10$ Hz to 100 kHz, $C_{out} = 10$ μF $C_{nr} = 10$ nF, $I_{load} = 500$ mA, $f = 10$ Hz to 100 kHz, $C_{out} = 10$ μF	V_{noise}		93 58		μVrms μVrms
Shutdown Threshold Voltage ON Threshold Voltage OFF		2.0		0.4	V V
S_D Input Current, $V_{SD} = 0$ V to 0.4 V or $V_{SD} = 2.0$ V to V_{in}	I_{SD}		0.07	1.0	μA
Output Current In Shutdown Mode, $V_{out} = 0$ V	I_{OSD}		0.07	1.0	μA
Reverse Bias Protection, Current Flowing from the Output Pin to GND ($V_{in} = 0$ V, $V_{out_forced} = 5.0$ V)	I_{OUTR}		10		μA

- Performance guaranteed over the operating temperature range by design and/or characterization, production tested at $T_J = T_A = 25^{\circ}\text{C}$. Low duty cycle pulse techniques are used during testing to maintain the junction temperature as close to ambient as possible.
- T_A must be greater than 0°C .

NCP3335A

ELECTRICAL CHARACTERISTICS – 3.3 V ($V_{out} = 3.3$ V typical, $V_{in} = 3.7$ V, $T_A = -40^{\circ}\text{C}$ to $+85^{\circ}\text{C}$, unless otherwise noted, Note 4.)

Characteristic	Symbol	Min	Typ	Max	Unit
Output Voltage (Accuracy) $V_{in} = 3.7$ V to 7.3 V, $I_{load} = 0.1$ mA to 500 mA, $T_A = 25^{\circ}\text{C}$	V_{out}	-0.9% 3.270	3.3	+0.9% 3.330	V
Output Voltage (Accuracy) $V_{in} = 3.7$ V to 7.3 V, $I_{load} = 0.1$ mA to 500 mA, $T_A = 0^{\circ}\text{C}$ to $+85^{\circ}\text{C}$	V_{out}	-1.4% 3.254	3.3	+1.4% 3.346	V
Output Voltage (Accuracy) $V_{in} = 3.7$ V to 7.3 V, $I_{load} = 0.1$ mA to 500 mA, $T_A = -40^{\circ}\text{C}$ to $+125^{\circ}\text{C}$	V_{out}	-1.5% 3.250	3.3	+1.5% 3.350	V
Line Regulation $V_{in} = 3.7$ V to 12 V, $I_{load} = 0.1$ mA	LineReg		0.04		mV/V
Load Regulation $V_{in} = 3.7$ V, $I_{load} = 0.1$ mA to 500 mA	LoadReg		0.04		mV/mA
Dropout Voltage (See App Note) $I_{load} = 500$ mA $I_{load} = 300$ mA $I_{load} = 50$ mA $I_{load} = 0.1$ mA	V_{DO}			340 230 110 10	mV
Peak Output Current (See Figure 16)	I_{pk}	500	700	800	mA
Short Output Current (See Figure 16)	I_{sc}			900	mA
Thermal Shutdown	T_J		160		$^{\circ}\text{C}$
Ground Current In Regulation $I_{load} = 500$ mA (Note 5) $I_{load} = 300$ mA $I_{load} = 50$ mA $I_{load} = 0.1$ mA In Dropout $V_{in} = 3.2$ V, $I_{load} = 0.1$ mA In Shutdown $S_D = 0$ V	I_{GND} I_{GNDsh}		9.0 4.6 0.8 – – 0.07	14 7.5 2.5 190 500 1.0	mA μA
Output Noise $C_{nr} = 0$ nF, $I_{load} = 500$ mA, $f = 10$ Hz to 100 kHz, $C_{out} = 10$ μF $C_{nr} = 10$ nF, $I_{load} = 500$ mA, $f = 10$ Hz to 100 kHz, $C_{out} = 10$ μF	V_{noise}		69 46		μVrms μVrms
Shutdown Threshold Voltage ON Threshold Voltage OFF		2.0		0.4	V V
S_D Input Current, $V_{SD} = 0$ V to 0.4 V or $V_{SD} = 2.0$ V to V_{in}	I_{SD}		0.07	1.0	μA
Output Current In Shutdown Mode, $V_{out} = 0$ V	I_{OSD}		0.07	1.0	μA
Reverse Bias Protection, Current Flowing from the Output Pin to GND ($V_{in} = 0$ V, $V_{out_forced} = 3.3$ V)	I_{OUTR}		10		μA

- Performance guaranteed over the operating temperature range by design and/or characterization, production tested at $T_J = T_A = 25^{\circ}\text{C}$. Low duty cycle pulse techniques are used during testing to maintain the junction temperature as close to ambient as possible.
- T_A must be greater than 0°C .

NCP3335A

ELECTRICAL CHARACTERISTICS – 3.0 V ($V_{out} = 3.0$ V typical, $V_{in} = 3.4$ V, $T_A = -40^{\circ}\text{C}$ to $+85^{\circ}\text{C}$, unless otherwise noted, Note 6.)

Characteristic	Symbol	Min	Typ	Max	Unit
Output Voltage (Accuracy) $V_{in} = 3.4$ V to 7.0 V, $I_{load} = 0.1$ mA to 500 mA, $T_A = 25^{\circ}\text{C}$	V_{out}	-0.9% 2.973	3.0	+0.9% 3.027	V
Output Voltage (Accuracy) $V_{in} = 3.4$ V to 7.0 V, $I_{load} = 0.1$ mA to 500 mA, $T_A = 0^{\circ}\text{C}$ to $+85^{\circ}\text{C}$	V_{out}	-1.4% 2.958	3.0	+1.4% 3.042	V
Output Voltage (Accuracy) $V_{in} = 3.4$ V to 7.0 V, $I_{load} = 0.1$ mA to 500 mA, $T_A = -40^{\circ}\text{C}$ to $+125^{\circ}\text{C}$	V_{out}	-1.5% 2.955	3.0	+1.5% 3.045	V
Line Regulation $V_{in} = 3.4$ V to 12 V, $I_{load} = 0.1$ mA	LineReg		0.04		mV/V
Load Regulation $V_{in} = 3.4$ V, $I_{load} = 0.1$ mA to 500 mA	LoadReg		0.04		mV/mA
Dropout Voltage (See App Note) $I_{load} = 500$ mA $I_{load} = 300$ mA $I_{load} = 50$ mA $I_{load} = 0.1$ mA	V_{DO}			340 230 110 10	mV
Peak Output Current (See Figure 16)	I_{pk}	500	700	800	mA
Short Output Current (See Figure 16)	I_{sc}			900	mA
Thermal Shutdown	T_J		160		$^{\circ}\text{C}$
Ground Current In Regulation $I_{load} = 500$ mA (Note 7) $I_{load} = 300$ mA $I_{load} = 50$ mA $I_{load} = 0.1$ mA In Dropout $V_{in} = 2.9$ V, $I_{load} = 0.1$ mA In Shutdown $S_D = 0$ V	I_{GND} I_{GNDsh}		9.0 4.6 0.8 – – 0.07	14 7.5 2.5 190 500 1.0	mA μA
Output Noise $C_{nr} = 0$ nF, $I_{load} = 500$ mA, $f = 10$ Hz to 100 kHz, $C_{out} = 10$ μF $C_{nr} = 10$ nF, $I_{load} = 500$ mA, $f = 10$ Hz to 100 kHz, $C_{out} = 10$ μF	V_{noise}		56 37		μVrms μVrms
Shutdown Threshold Voltage ON Threshold Voltage OFF		2.0		0.4	V V
S_D Input Current, $V_{SD} = 0$ V to 0.4 V or $V_{SD} = 2.0$ V to V_{in}	I_{SD}		0.07	1.0	μA
Output Current In Shutdown Mode, $V_{out} = 0$ V	I_{OSD}		0.07	1.0	μA
Reverse Bias Protection, Current Flowing from the Output Pin to GND ($V_{in} = 0$ V, $V_{out_forced} = 3.0$ V)	I_{OUTR}		10		μA

6. Performance guaranteed over the operating temperature range by design and/or characterization, production tested at $T_J = T_A = 25^{\circ}\text{C}$. Low duty cycle pulse techniques are used during testing to maintain the junction temperature as close to ambient as possible.
7. T_A must be greater than 0°C .

NCP3335A

ELECTRICAL CHARACTERISTICS – 2.85 V ($V_{out} = 2.85$ V typical, $V_{in} = 3.25$ V, $T_A = -40^{\circ}\text{C}$ to $+85^{\circ}\text{C}$, unless otherwise noted, Note 8)

Characteristic	Symbol	Min	Typ	Max	Unit
Output Voltage (Accuracy) $V_{in} = 3.25$ V to 6.85 V, $I_{load} = 0.1$ mA to 500 mA, $T_A = 25^{\circ}\text{C}$	V_{out}	-0.9% 2.824	2.85	+0.9% 2.876	V
Output Voltage (Accuracy) $V_{in} = 3.25$ V to 6.85 V, $I_{load} = 0.1$ mA to 500 mA, $T_A = 0^{\circ}\text{C}$ to $+85^{\circ}\text{C}$	V_{out}	-1.4% 2.810	2.85	+1.4% 2.890	V
Output Voltage (Accuracy) (Note 9) $V_{in} = 3.25$ V to 6.85 V, $I_{load} = 0.1$ mA to 500 mA, $T_A = -40^{\circ}\text{C}$ to $+125^{\circ}\text{C}$	V_{out}	-1.5% 2.807	2.85	+1.5% 2.893	V
Line Regulation $V_{in} = 3.25$ V to 12 V, $I_{load} = 0.1$ mA	LineReg		0.04		mV/V
Load Regulation $V_{in} = 3.25$ V, $I_{load} = 0.1$ mA to 500 mA	LoadReg		0.04		mV/mA
Dropout Voltage (See App Note) $I_{load} = 500$ mA $I_{load} = 300$ mA $I_{load} = 50$ mA $I_{load} = 0.1$ mA	V_{DO}			340 230 110 10	mV
Peak Output Current (See Figure 16)	I_{pk}	500	700	800	mA
Short Output Current (See Figure 16)	I_{sc}			900	mA
Thermal Shutdown	T_J		160		$^{\circ}\text{C}$
Ground Current In Regulation $I_{load} = 500$ mA (Note 10) $I_{load} = 300$ mA $I_{load} = 50$ mA $I_{load} = 0.1$ mA In Dropout $V_{in} = 2.75$ V, $I_{load} = 0.1$ mA In Shutdown $S_D = 0$ V	I_{GND}		9.0 4.6 0.8 –	14 7.5 2.5 190	mA μA
Output Noise $C_{nr} = 0$ nF, $I_{load} = 500$ mA, $f = 10$ Hz to 100 kHz, $C_{out} = 10$ μF $C_{nr} = 10$ nF, $I_{load} = 500$ mA, $f = 10$ Hz to 100 kHz, $C_{out} = 10$ μF	V_{noise}		61 40		μVrms μVrms
Shutdown Threshold Voltage ON Threshold Voltage OFF		2.0		0.4	V V
S_D Input Current, $V_{SD} = 0$ V to 0.4 V or $V_{SD} = 2.0$ V to V_{in}	I_{SD}		0.07	1.0	μA
Output Current In Shutdown Mode, $V_{out} = 0$ V	I_{OSD}		0.07	1.0	μA
Reverse Bias Protection, Current Flowing from the Output Pin to GND ($V_{in} = 0$ V, $V_{out_forced} = 2.85$ V)	I_{OUTR}		10		μA

8. Performance guaranteed over the operating temperature range by design and/or characterization, production tested at $T_J = T_A = 25^{\circ}\text{C}$. Low duty cycle pulse techniques are used during testing to maintain the junction temperature as close to ambient as possible.
9. For output current capability for $T_A < 0^{\circ}\text{C}$, please refer to Figure 18.
10. T_A must be greater than 0°C .

NCP3335A

ELECTRICAL CHARACTERISTICS – 2.8 V ($V_{out} = 2.8$ V typical, $V_{in} = 3.2$ V, $T_A = -40^\circ\text{C}$ to $+85^\circ\text{C}$, unless otherwise noted, Note 11.)

Characteristic	Symbol	Min	Typ	Max	Unit
Output Voltage (Accuracy) $V_{in} = 3.2$ V to 6.8 V, $I_{load} = 0.1$ mA to 500 mA, $T_A = 25^\circ\text{C}$	V_{out}	-0.9% 2.774	2.8	+0.9% 2.826	V
Output Voltage (Accuracy) $V_{in} = 3.2$ V to 6.8 V, $I_{load} = 0.1$ mA to 500 mA, $T_A = 0^\circ\text{C}$ to $+85^\circ\text{C}$	V_{out}	-1.4% 2.760	2.8	+1.4% 2.840	V
Output Voltage (Accuracy) (Note 12) $V_{in} = 3.2$ V to 6.8 V, $I_{load} = 0.1$ mA to 500 mA, $T_A = -40^\circ\text{C}$ to $+125^\circ\text{C}$	V_{out}	-1.5% 2.758	2.8	+1.5% 2.842	V
Line Regulation $V_{in} = 3.2$ V to 12 V, $I_{load} = 0.1$ mA	LineReg		0.04		mV/V
Load Regulation $V_{in} = 3.2$ V, $I_{load} = 0.1$ mA to 500 mA	LoadReg		0.04		mV/mA
Dropout Voltage (See App Note) $I_{load} = 500$ mA $I_{load} = 300$ mA $I_{load} = 50$ mA $I_{load} = 0.1$ mA	V_{DO}			340 230 110 10	mV
Peak Output Current (See Figure 16)	I_{pk}	500	700	800	mA
Short Output Current (See Figure 16)	I_{sc}			900	mA
Thermal Shutdown	T_J		160		$^\circ\text{C}$
Ground Current In Regulation $I_{load} = 500$ mA (Note 13) $I_{load} = 300$ mA (Note 13) $I_{load} = 50$ mA $I_{load} = 0.1$ mA In Dropout $V_{in} = 2.7$ V, $I_{load} = 0.1$ mA In Shutdown $S_D = 0$ V	I_{GND}		9.0 4.6 0.8 –	14 7.5 2.5 190	mA μA
Output Noise $C_{nr} = 0$ nF, $I_{load} = 500$ mA, $f = 10$ Hz to 100 kHz, $C_{out} = 10$ μF $C_{nr} = 10$ nF, $I_{load} = 500$ mA, $f = 10$ Hz to 100 kHz, $C_{out} = 10$ μF	V_{noise}		52 36		μVrms μVrms
Shutdown Threshold Voltage ON Threshold Voltage OFF		2.0		0.4	V V
S_D Input Current, $V_{SD} = 0$ V to 0.4 V or $V_{SD} = 2.0$ V to V_{in}	I_{SD}		0.07	1.0	μA
Output Current In Shutdown Mode, $V_{out} = 0$ V	I_{OSD}		0.07	1.0	μA
Reverse Bias Protection, Current Flowing from the Output Pin to GND ($V_{in} = 0$ V, $V_{out_forced} = 2.8$ V)	I_{OUTR}		10		μA

11. Performance guaranteed over the operating temperature range by design and/or characterization, production tested at $T_J = T_A = 25^\circ\text{C}$. Low duty cycle pulse techniques are used during testing to maintain the junction temperature as close to ambient as possible.

12. For output current capability for $T_A < 0^\circ\text{C}$, please refer to Figure 19.

13. T_A must be greater than 0°C .

NCP3335A

ELECTRICAL CHARACTERISTICS – 2.5 V ($V_{out} = 2.5$ V typical, $V_{in} = 2.9$ V, $T_A = -40^{\circ}\text{C}$ to $+85^{\circ}\text{C}$, unless otherwise noted, Note 14.)

Characteristic	Symbol	Min	Typ	Max	Unit
Output Voltage (Accuracy) $V_{in} = 2.9$ V to 6.5 V, $I_{load} = 0.1$ mA to 500 mA, $T_A = 25^{\circ}\text{C}$	V_{out}	-0.9% 2.477	2.5	+0.9% 2.523	V
Output Voltage (Accuracy) $V_{in} = 2.9$ V to 6.5 V, $I_{load} = 0.1$ mA to 500 mA, $T_A = 0^{\circ}\text{C}$ to $+85^{\circ}\text{C}$	V_{out}	-1.4% 2.465	2.5	+1.4% 2.535	V
Output Voltage (Accuracy), (Note 15) $V_{in} = 2.9$ V to 6.5 V, $I_{load} = 0.1$ mA to 500 mA, $T_A = -40^{\circ}\text{C}$ to $+125^{\circ}\text{C}$	V_{out}	-1.5% 2.462	2.5	+1.5% 2.538	V
Line Regulation $V_{in} = 2.9$ V to 12 V, $I_{load} = 0.1$ mA	LineReg		0.04		mV/V
Load Regulation $V_{in} = 2.9$ V, $I_{load} = 0.1$ mA to 500 mA	LoadReg		0.04		mV/mA
Dropout Voltage (See App Note) $I_{load} = 500$ mA (Note 16) $I_{load} = 300$ mA (Note 16) $I_{load} = 50$ mA $I_{load} = 0.1$ mA	V_{DO}			340 230 110 10	mV
Peak Output Current (See Figure 16)	I_{pk}	500	700	800	mA
Short Output Current (See Figure 16)	I_{sc}			900	mA
Thermal Shutdown	T_J		160		$^{\circ}\text{C}$
Ground Current In Regulation $I_{load} = 500$ mA (Note 16) $I_{load} = 300$ mA (Note 16) $I_{load} = 50$ mA $I_{load} = 0.1$ mA In Dropout $V_{in} = 2.4$ V, $I_{load} = 0.1$ mA In Shutdown $S_D = 0$ V	I_{GND}		9.0 4.6 0.8 –	14 7.5 2.5 190	mA μA
Output Noise $C_{nr} = 0$ nF, $I_{load} = 500$ mA, $f = 10$ Hz to 100 kHz, $C_{out} = 10$ μF $C_{nr} = 10$ nF, $I_{load} = 500$ mA, $f = 10$ Hz to 100 kHz, $C_{out} = 10$ μF	V_{noise}		56 35		μVrms μVrms
Shutdown Threshold Voltage ON Threshold Voltage OFF		2.0		0.4	V V
S_D Input Current, $V_{SD} = 0$ V to 0.4 V or $V_{SD} = 2.0$ V to V_{in}	I_{SD}		0.07	1.0	μA
Output Current In Shutdown Mode, $V_{out} = 0$ V	I_{OSD}		0.07	1.0	μA
Reverse Bias Protection, Current Flowing from the Output Pin to GND ($V_{in} = 0$ V, $V_{out_forced} = 2.5$ V)	I_{OUTR}		10		μA

14. Performance guaranteed over the operating temperature range by design and/or characterization, production tested at $T_J = T_A = 25^{\circ}\text{C}$. Low duty cycle pulse techniques are used during testing to maintain the junction temperature as close to ambient as possible.

15. For output current capability for $T_A < 0^{\circ}\text{C}$, please refer to Figure 20.

16. T_A must be greater than 0°C .

NCP3335A

ELECTRICAL CHARACTERISTICS – 1.8 V ($V_{out} = 1.8$ V typical, $V_{in} = 2.9$ V, $T_A = -40^{\circ}\text{C}$ to $+85^{\circ}\text{C}$, unless otherwise noted, Note 17.)

Characteristic	Symbol	Min	Typ	Max	Unit
Output Voltage (Accuracy) $V_{in} = 2.9$ V to 5.8 V, $I_{load} = 0.1$ mA to 500 mA, $T_A = 25^{\circ}\text{C}$	V_{out}	-0.9% 1.783	1.8	+0.9% 1.817	V
Output Voltage (Accuracy) $V_{in} = 2.9$ V to 5.8 V, $I_{load} = 0.1$ mA to 500 mA, $T_A = 0^{\circ}\text{C}$ to $+85^{\circ}\text{C}$	V_{out}	-1.4% 1.774	1.8	+1.4% 1.826	V
Output Voltage (Accuracy), (Note 18) $V_{in} = 2.9$ V to 5.8 V, $I_{load} = 0.1$ mA to 500 mA, $T_A = -40^{\circ}\text{C}$ to $+125^{\circ}\text{C}$	V_{out}	-1.5% 1.773	1.8	+1.5% 1.827	V
Line Regulation $V_{in} = 2.9$ V to 12 V, $I_{load} = 0.1$ mA	LineReg		0.04		mV/V
Load Regulation $V_{in} = 2.9$ V, $I_{load} = 0.1$ mA to 500 mA	LoadReg		0.04		mV/mA
Dropout Voltage (See App Note) $I_{load} = 500$ mA (Notes 19, 20) $I_{load} = 300$ mA (Notes 19, 20) $I_{load} = 50$ mA (Notes 19, 20)	V_{DO}		620 230 95	1130 1130 1130	mV
Peak Output Current (See Figure 16)	I_{pk}	500	700	830	mA
Short Output Current (See Figure 16)	I_{sc}			900	mA
Thermal Shutdown	T_J		160		$^{\circ}\text{C}$
Ground Current In Regulation $I_{load} = 500$ mA (Note 19) $I_{load} = 300$ mA (Note 19) $I_{load} = 50$ mA $I_{load} = 0.1$ mA In Dropout $V_{in} = 2.2$ V, $I_{load} = 0.1$ mA In Shutdown $S_D = 0$ V	I_{GND} I_{GNDsh}		9.0 4.6 0.8 –	14 7.5 2.5 190 500	mA μA
Output Noise $C_{nr} = 0$ nF, $I_{load} = 500$ mA, $f = 10$ Hz to 100 kHz, $C_{out} = 10$ μF $C_{nr} = 10$ nF, $I_{load} = 500$ mA, $f = 10$ Hz to 100 kHz, $C_{out} = 10$ μF	V_{noise}		52 33		μV_{rms} μV_{rms}
Shutdown Threshold Voltage ON Threshold Voltage OFF		2.0		0.4	V V
S_D Input Current, $V_{SD} = 0$ V to 0.4 V or $V_{SD} = 2.0$ V to V_{in}	I_{SD}		0.07	1.0	μA
Output Current In Shutdown Mode, $V_{out} = 0$ V	I_{OSD}		0.07	1.0	μA
Reverse Bias Protection, Current Flowing from the Output Pin to GND ($V_{in} = 0$ V, $V_{out_forced} = 1.8$ V)	I_{OUTR}		10		μA

17. Performance guaranteed over the operating temperature range by design and/or characterization, production tested at $T_J = T_A = 25^{\circ}\text{C}$. Low duty cycle pulse techniques are used during testing to maintain the junction temperature as close to ambient as possible.

18. For output current capability for $T_A < 0^{\circ}\text{C}$, please refer to Figure 21.

19. T_A must be greater than 0°C .

20. Maximum dropout voltage is limited by minimum input voltage $V_{in} = 2.9$ V recommended for guaranteed operation.

NCP3335A

ELECTRICAL CHARACTERISTICS – 1.5 V ($V_{out} = 1.5$ V typical, $V_{in} = 2.9$ V, $T_A = -40^{\circ}\text{C}$ to $+85^{\circ}\text{C}$, unless otherwise noted, Note 21.)

Characteristic	Symbol	Min	Typ	Max	Unit
Output Voltage (Accuracy) $V_{in} = 2.9$ V to 5.5 V, $I_{load} = 0.1$ mA to 500 mA, $T_A = 25^{\circ}\text{C}$	V_{out}	-0.9% 1.486	1.5	+0.9% 1.514	V
Output Voltage (Accuracy) $V_{in} = 2.9$ V to 5.5 V, $I_{load} = 0.1$ mA to 500 mA, $T_A = 0^{\circ}\text{C}$ to $+85^{\circ}\text{C}$	V_{out}	-1.4% 1.479	1.5	+1.4% 1.521	V
Output Voltage (Accuracy), (Note 22) $V_{in} = 2.9$ V to 5.5 V, $I_{load} = 0.1$ mA to 500 mA, $T_A = -40^{\circ}\text{C}$ to $+125^{\circ}\text{C}$	V_{out}	-1.5% 1.477	1.5	+1.5% 1.523	V
Line Regulation $V_{in} = 2.9$ V to 12 V, $I_{load} = 0.1$ mA	LineReg		0.04		mV/V
Load Regulation $V_{in} = 2.9$ V, $I_{load} = 0.1$ mA to 500 mA	LoadReg		0.04		mV/mA
Dropout Voltage (See App Note) $I_{load} = 500$ mA (Notes 23, 24) $I_{load} = 300$ mA (Notes 23, 24) $I_{load} = 50$ mA (Notes 23, 24)	V_{DO}		940 500 350	1430 1430 1430	mV
Peak Output Current (See Figure 16)	I_{pk}	500	700	860	mA
Short Output Current (See Figure 16)	I_{sc}			900	mA
Thermal Shutdown	T_J		160		$^{\circ}\text{C}$
Ground Current In Regulation $I_{load} = 500$ mA (Note 23) $I_{load} = 300$ mA (Note 23) $I_{load} = 50$ mA $I_{load} = 0.1$ mA In Dropout $V_{in} = 2.2$ V, $I_{load} = 0.1$ mA In Shutdown $S_D = 0$ V	I_{GND}		9.0 4.6 0.8 –	14 7.5 2.5 190	mA μA
Output Noise $C_{nr} = 0$ nF, $I_{load} = 500$ mA, $f = 10$ Hz to 100 kHz, $C_{out} = 10$ μF $C_{nr} = 10$ nF, $I_{load} = 500$ mA, $f = 10$ Hz to 100 kHz, $C_{out} = 10$ μF	V_{noise}		51 31		μV_{rms} μV_{rms}
Shutdown Threshold Voltage ON Threshold Voltage OFF		2.0		0.4	V V
S_D Input Current, $V_{SD} = 0$ V to 0.4 V or $V_{SD} = 2.0$ V to V_{in}	I_{SD}		0.07	1.0	μA
Output Current In Shutdown Mode, $V_{out} = 0$ V	I_{OSD}		0.07	1.0	μA
Reverse Bias Protection, Current Flowing from the Output Pin to GND ($V_{in} = 0$ V, $V_{out_forced} = 1.5$ V)	I_{OUTR}		10		μA

21. Performance guaranteed over the operating temperature range by design and/or characterization, production tested at $T_J = T_A = 25^{\circ}\text{C}$. Low duty cycle pulse techniques are used during testing to maintain the junction temperature as close to ambient as possible.

22. For output current capability for $T_A < 0^{\circ}\text{C}$, please refer to Figure 22.

23. T_A must be greater than 0°C .

24. Maximum dropout voltage is limited by minimum input voltage $V_{in} = 2.9$ V recommended for guaranteed operation.

NCP3335A

ELECTRICAL CHARACTERISTICS – Adjustable ($V_{out} = 1.25\text{ V}$ typical, $V_{in} = 2.9\text{ V}$, $T_A = -40^\circ\text{C}$ to $+85^\circ\text{C}$, unless otherwise noted, Note 25)

Characteristic	Symbol	Min	Typ	Max	Unit
Reference Voltage (Accuracy) $V_{in} = 2.9\text{ V}$ to $V_{out} + 4.0\text{ V}$, $I_{load} = 0.1\text{ mA}$ to 500 mA , $T_A = 25^\circ\text{C}$	V_{ref}	-0.9% 1.239	1.25	+0.9% 1.261	V
Reference Voltage (Accuracy) $V_{in} = 2.9\text{ V}$ to $V_{out} + 4.0\text{ V}$, $I_{load} = 0.1\text{ mA}$ to 500 mA , $T_A = 0^\circ\text{C}$ to $+85^\circ\text{C}$	V_{ref}	-1.4% 1.233	1.25	+1.4% 1.268	V
Reference Voltage (Accuracy) (Note 26) $V_{in} = 2.9\text{ V}$ to $V_{out} + 4.0\text{ V}$, $I_{load} = 0.1\text{ mA}$ to 500 mA , $T_A = -40^\circ\text{C}$ to $+125^\circ\text{C}$	V_{ref}	-1.5% 1.231	1.25	+1.5% 1.269	V
Line Regulation $V_{in} = 2.9\text{ V}$ to 12 V , $I_{load} = 0.1\text{ mA}$	LineReg		0.04		mV/V
Load Regulation $V_{in} = 2.9\text{ V}$, $I_{load} = 0.1\text{ mA}$ to 500 mA	LoadReg		0.04		mV/mA
Dropout Voltage (See App Note), $V_{out} = 2.5\text{ V}$ to 10 V $I_{load} = 500\text{ mA}$ (Note 27) $I_{load} = 300\text{ mA}$ $I_{load} = 50\text{ mA}$ $I_{load} = 0.1\text{ mA}$	V_{DO}			340 230 110 10	mV
Peak Output Current (Note 27) (See Figure 16)	I_{pk}	500	700	860	mA
Short Output Current (See Figure 16) $V_{out} \leq 3.3\text{ V}$ $V_{out} > 3.3\text{ V}$	I_{sc}			900 990	mA
Thermal Shutdown	T_J		160		$^\circ\text{C}$
Ground Current In Regulation $I_{load} = 500\text{ mA}$ (Note 27) $I_{load} = 300\text{ mA}$ (Note 27) $I_{load} = 50\text{ mA}$ $I_{load} = 0.1\text{ mA}$ In Dropout $V_{in} = V_{out} - 0.1\text{ V}$ or 2.2 V (whichever is higher), $I_{load} = 0.1\text{ mA}$ In Shutdown $S_D = 0\text{ V}$	I_{GND} I_{GNDsh}		9.0 4.6 0.8 – – 0.07	14 7.5 2.5 190 500 1.0	mA μA
Output Noise $C_{nr} = 0\text{ nF}$, $I_{load} = 500\text{ mA}$, $f = 10\text{ Hz}$ to 100 kHz , $C_{out} = 10\text{ }\mu\text{F}$ $C_{nr} = 10\text{ nF}$, $I_{load} = 500\text{ mA}$, $f = 10\text{ Hz}$ to 100 kHz , $C_{out} = 10\text{ }\mu\text{F}$	V_{noise}		38 26		μVrms μVrms
Shutdown Threshold Voltage ON Threshold Voltage OFF		2.0		0.4	V V
S_D Input Current, $V_{SD} = 0\text{ V}$ to 0.4 V or $V_{SD} = 2.0\text{ V}$ to V_{in} $V_{in} \leq 5.4\text{ V}$ $V_{in} > 5.4\text{ V}$	I_{SD}		0.07	1.0 5.0	μA
Output Current In Shutdown Mode, $V_{out} = 0\text{ V}$	I_{OSD}		0.07	1.0	μA
Reverse Bias Protection, Current Flowing from the Output Pin to GND ($V_{in} = 0\text{ V}$, $V_{out_forced} = V_{out}(\text{nom}) \leq 7\text{ V}$) (Note 28)	I_{OUTR}		1.0		μA

25. Performance guaranteed over the operating temperature range by design and/or characterization, production tested at $T_J = T_A = 25^\circ\text{C}$. Low duty cycle pulse techniques are used during testing to maintain the junction temperature as close to ambient as possible.

26. For output current capability for $T_A < 0^\circ\text{C}$, please refer to Figures 18 to 22.

27. T_A must be greater than 0°C .

28. Reverse bias protection feature valid only if $V_{out} - V_{in} \leq 7\text{ V}$.

NCP3335A

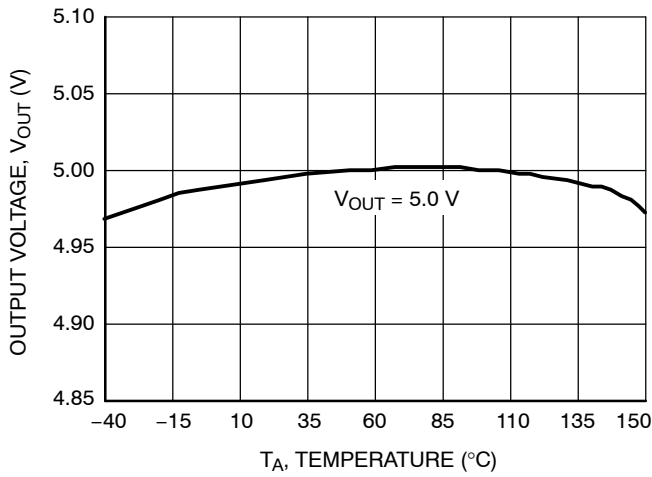

Figure 5. Output Voltage vs. Temperature
5.0 V Version

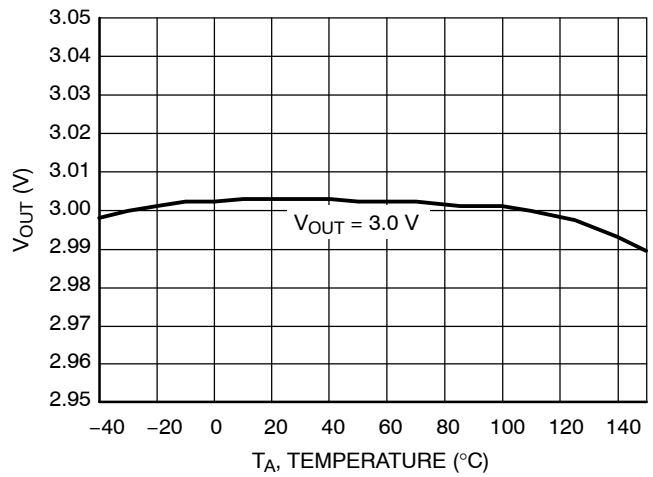

Figure 6. Output Voltage vs. Temperature
3.0 V Version

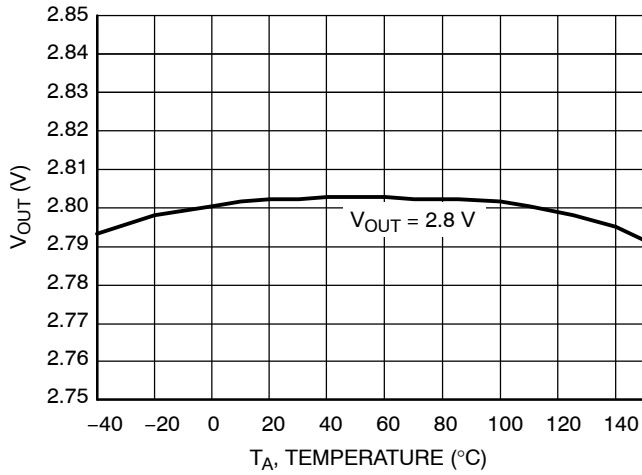

Figure 7. Output Voltage vs. Temperature
2.8 V Version

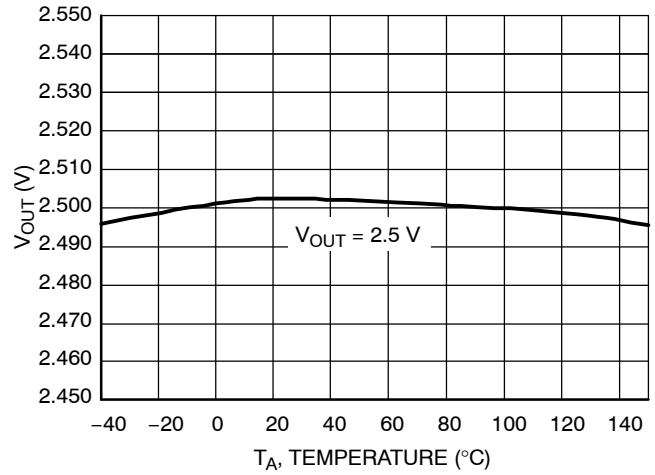

Figure 8. Output Voltage vs. Temperature
2.5 V Version

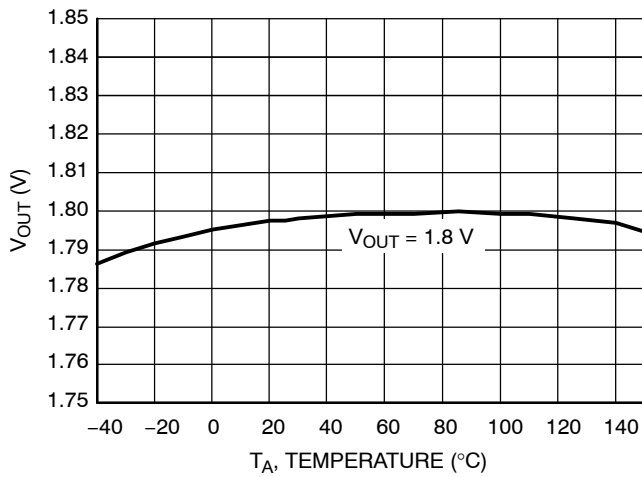

Figure 9. Output Voltage vs. Temperature
1.8 V Version

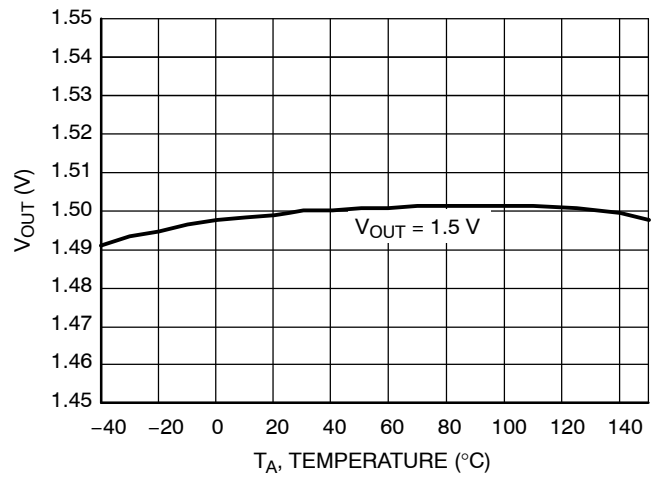
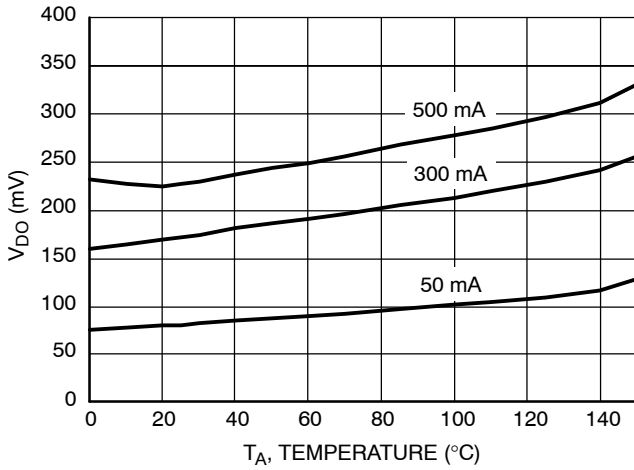
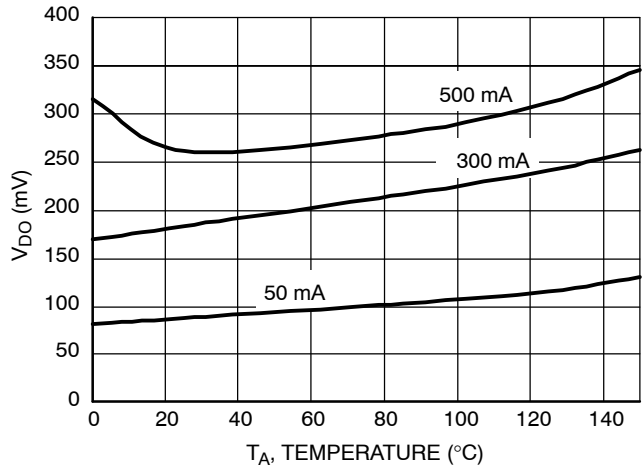

Figure 10. Output Voltage vs. Temperature
1.5 V Version

NCP3335A



**Figure 11. Dropout Voltage vs. Temperature
2.8 V Version**



**Figure 12. Dropout Voltage vs. Temperature
2.5 V Version**

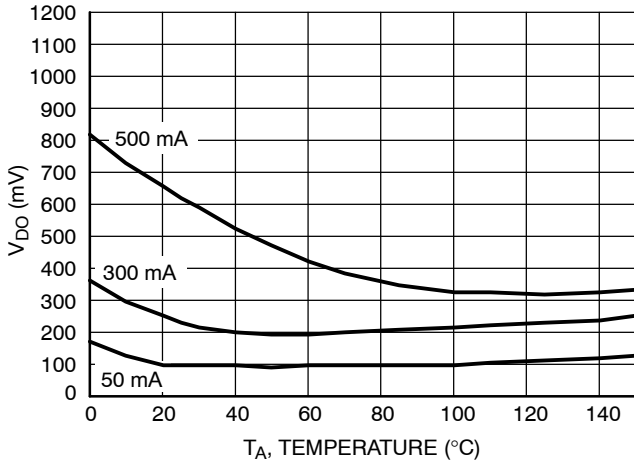

**Figure 13. Dropout Voltage vs. Temperature
1.8 V Version**

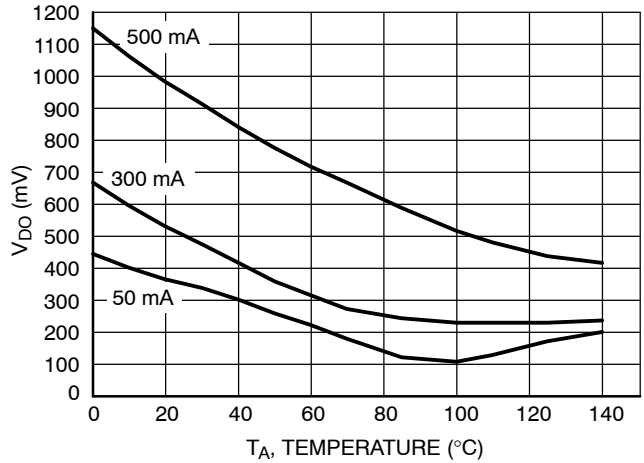

**Figure 14. Dropout Voltage vs. Temperature
1.5 V Version**

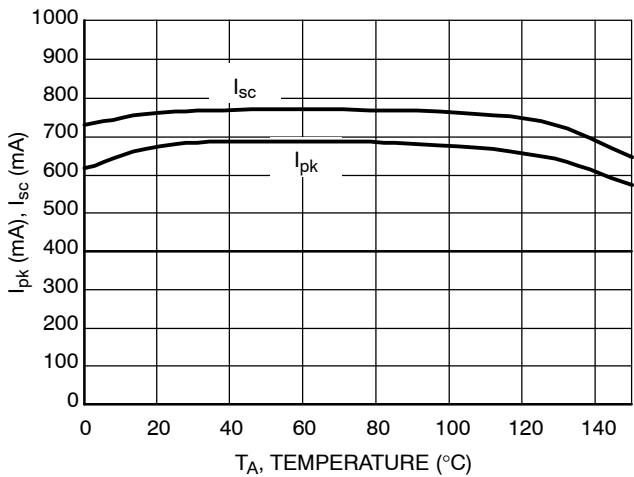

**Figure 15. Peak and Short Current
vs. Temperature**

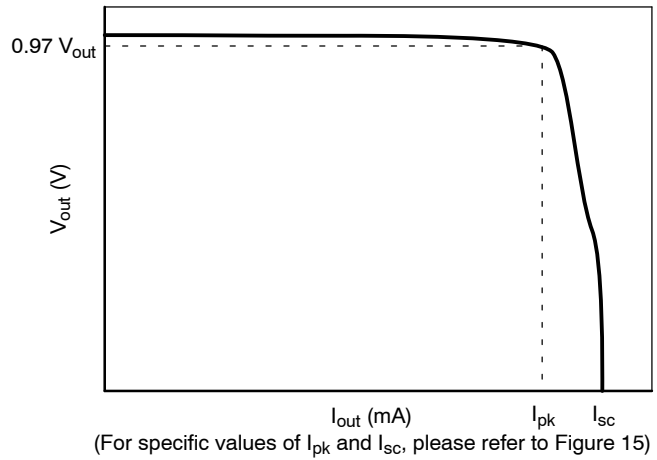

Figure 16. Output Voltage vs. Output Current
(For specific values of I_{pk} and I_{sc} , please refer to Figure 15)

NCP3335A

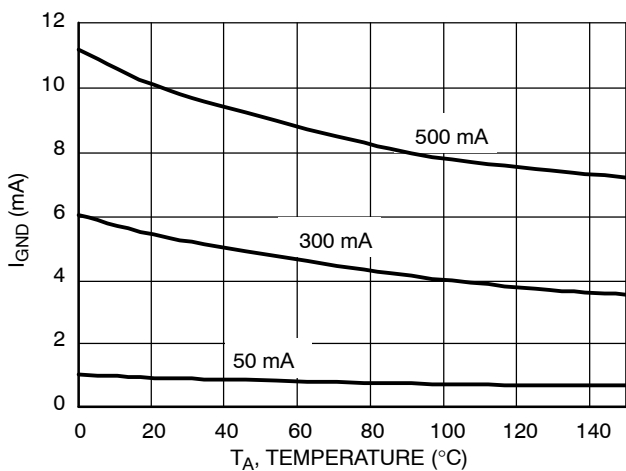

Figure 17. Ground Current vs. Temperature

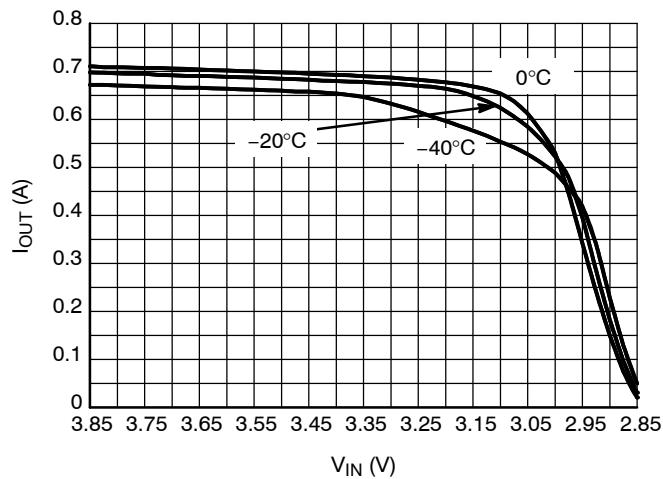

Figure 18. Output Current Capability for the 2.85 V Version

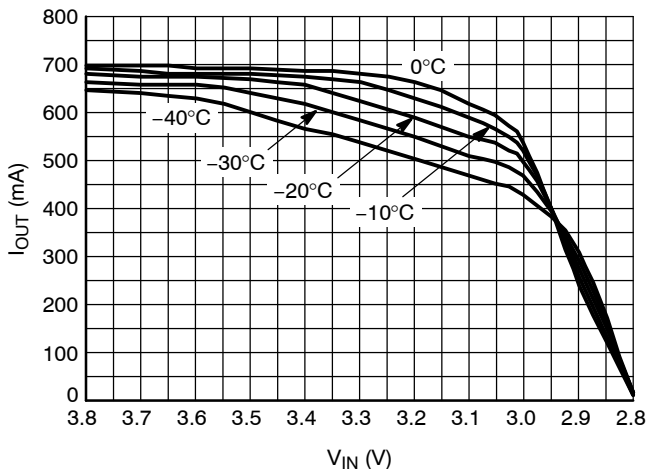

Figure 19. Output Current Capability for the 2.8 V Version

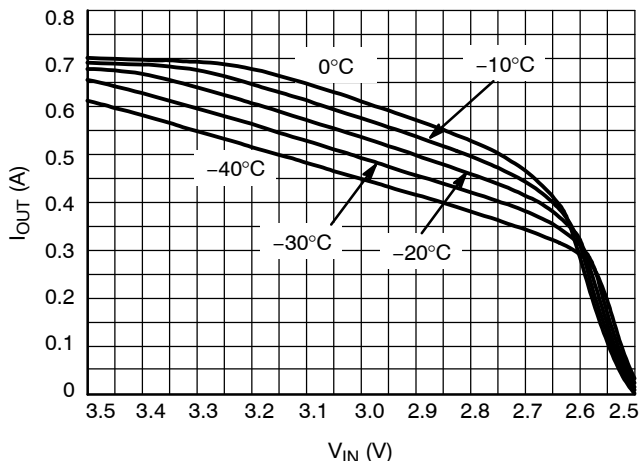

Figure 20. Output Current Capability for the 2.5 V Version

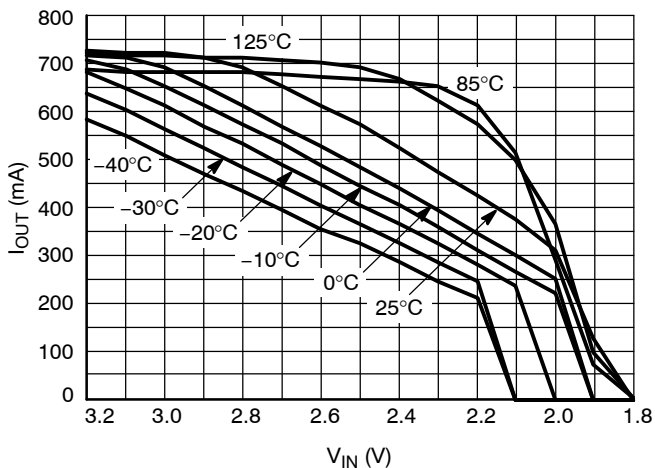

Figure 21. Output Current Capability for the 1.8 V Version

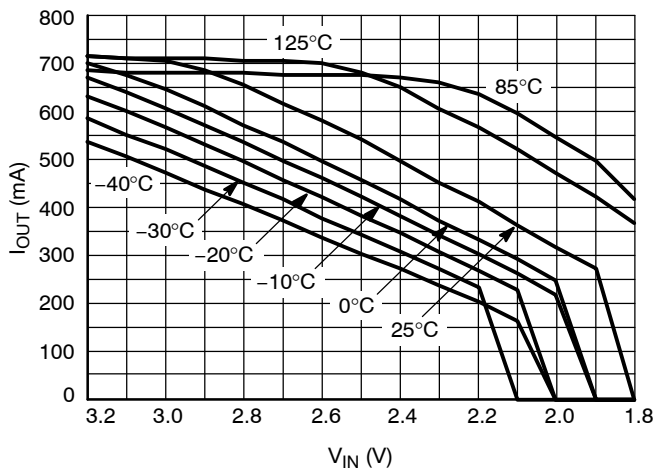

Figure 22. Output Current Capability for the 1.5 V Version

NCP3335A

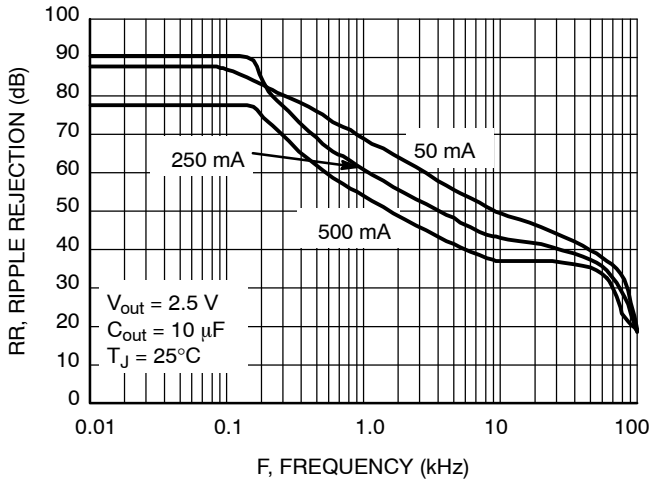

Figure 23. Ripple Rejection vs. Frequency

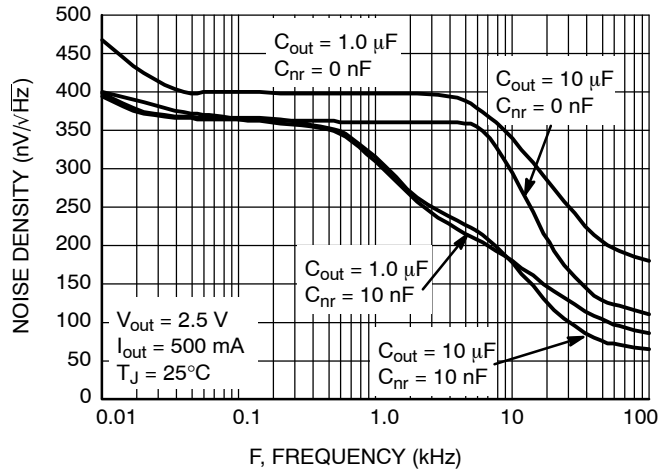

Figure 24. Output Noise Density

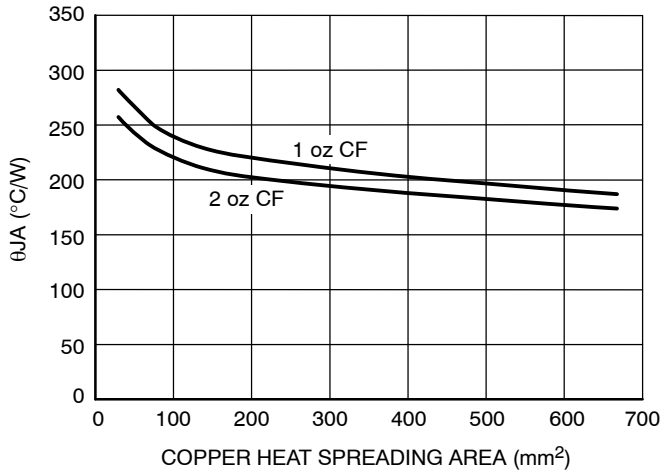

Figure 25. Micro 8 Self Heating Thermal Characteristic as a Function of Copper Area on the PCB

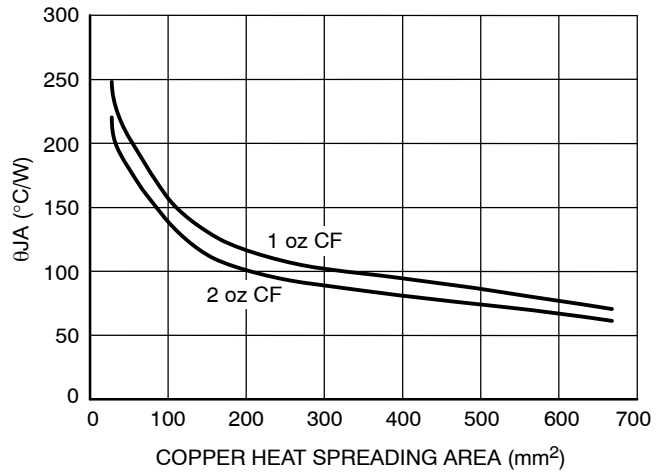

Figure 26. DFN 10 Self Heating Thermal Characteristic as a Function of Copper Area on the PCB

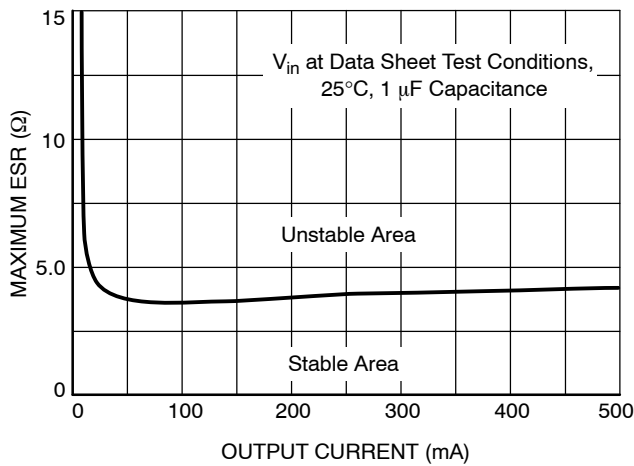

Figure 27. Stability with ESR vs. I_{out}

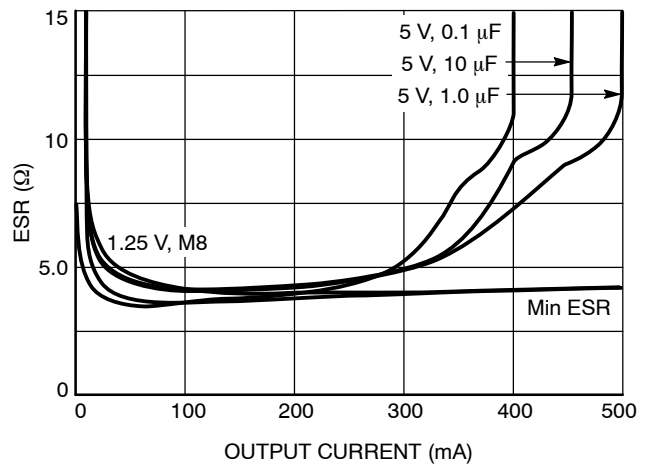

Figure 28. Output Current vs. ESR

NOTE: Typical characteristics were measured with the same conditions as electrical characteristics.

APPLICATIONS INFORMATION

Reverse Bias Protection

Reverse bias is a condition caused when the input voltage goes to zero, but the output voltage is kept high either by a large output capacitor or another source in the application which feeds the output pin.

Normally in a bipolar LDO all the current will flow from the output pin to input pin through the PN junction with limited current capability and with the potential to destroy the IC.

Due to an improved architecture, the NCP3335A can withstand up to 7.0 V on the output pin with virtually no current flowing from output pin to input pin, and only negligible amount of current (tens of μA) flowing from the output pin to ground for infinite duration.

Input Capacitor

An input capacitor of at least 1.0 μF , any type, is recommended to improve the transient response of the regulator and/or if the regulator is located more than a few inches from the power source. It will also reduce the circuit's sensitivity to the input line impedance at high frequencies. The capacitor should be mounted with the shortest possible track length directly across the regular's input terminals.

Output Capacitor

The NCP3335A remains stable with any type of capacitor as long as it fulfills its 1.0 μF requirement. There are no constraints on the minimum ESR and it will remain stable up to an ESR of 5.0 Ω . Larger capacitor values will improve the noise rejection and load transient response.

Noise Reduction Pin

Output noise can be greatly reduced by connecting a 10 nF capacitor (C_{nr}) between the noise reduction pin and ground (see Figure 1). In applications where very low noise is not required, the noise reduction pin can be left unconnected.

For the adjustable version, in addition to the 10 nF C_{nr} , a 68 pF capacitor connected in parallel with R1 (see Figure 2)

is recommended to further reduce output noise and improve stability.

Adjustable Operation

The output voltage can be set by using a resistor divider as shown in Figure 2 with a range of 1.25 to 10 V. The appropriate resistor divider can be found by solving the equation below. The recommended current through the resistor divider is from 10 μA to 100 μA . This can be accomplished by selecting resistors in the $\text{k}\Omega$ range. As result, the $I_{adj} * R2$ becomes negligible in the equation and can be ignored.

$$V_{out} = 1.25 * \left(1 + \frac{R1}{R2}\right) + I_{adj} * R2 \quad (\text{eq. 1})$$

Example:

For $V_{out} = 2.9 \text{ V}$, can use $R1 = 36 \text{ k}\Omega$ and $R2 = 27 \text{ k}\Omega$.

$$1.25 * \left(1 + \frac{36 \text{ k}\Omega}{27 \text{ k}\Omega}\right) = 2.91 \text{ V} \quad (\text{eq. 2})$$

Dropout Voltage

The voltage dropout is measured at 97% of the nominal output voltage.

Thermal Considerations

Internal thermal limiting circuitry is provided to protect the integrated circuit in the event that the maximum junction temperature is exceeded. This feature provides protection from a catastrophic device failure due to accidental overheating. This protection feature is not intended to be used as a substitute to heat sinking. The maximum power that can be dissipated, can be calculated with the equation below:

$$P_D = \frac{T_{J(max)} - T_A}{R_{\theta JA}} \quad (\text{eq. 3})$$

For improved thermal performance, contact the factory for the DFN package option. The DFN package includes an exposed metal pad that is specifically designed to reduce the junction to air thermal resistance, $R_{\theta JA}$.

NCP3335A

ORDERING INFORMATION

Device	Nominal Output Voltage	Marking	Package	Shipping†
NCP3335ADM150R2G	1.5 V	LKI	Micro8 (Pb-Free)	4000 / Tape & Reel
NCP3335ADM180R2G	1.8 V	LKJ	Micro8 (Pb-Free)	4000 / Tape & Reel
NCP3335ADM250R2G	2.5 V	LIQ	Micro8 (Pb-Free)	4000 / Tape & Reel
NCP3335ADM280R2G	2.8 V	LKK	Micro8 (Pb-Free)	4000 / Tape & Reel
NCP3335ADM285R2G	2.85 V	LIR	Micro8 (Pb-Free)	4000 / Tape & Reel
NCP3335ADM300R2G	3.0 V	LKL	Micro8 (Pb-Free)	4000 / Tape & Reel
NCP3335ADM330R2G	3.3 V	LIS	Micro8 (Pb-Free)	4000 / Tape & Reel
NCP3335ADM500R2G	5.0 V	LIT	Micro8 (Pb-Free)	4000 / Tape & Reel
NCP3335ADMADJR2G	Adj.	LIO	Micro8 (Pb-Free)	4000 / Tape & Reel
NCP3335AMN150R2G	1.5 V	15	DFN10 (Pb-Free)	3000 / Tape & Reel
NCP3335AMN180R2G	1.8 V	18	DFN10 (Pb-Free)	3000 / Tape & Reel
NCP3335AMN250R2G	2.5 V	25	DFN10 (Pb-Free)	3000 / Tape & Reel
NCP3335AMN280R2G	2.8 V	28	DFN10 (Pb-Free)	3000 / Tape & Reel
NCP3335AMN285R2G	2.85 V	285	DFN10 (Pb-Free)	3000 / Tape & Reel
NCP3335AMN300R2G	3.0 V	30	DFN10 (Pb-Free)	3000 / Tape & Reel
NCP3335AMN330R2G	3.3 V	33	DFN10 (Pb-Free)	3000 / Tape & Reel
NCP3335AMN500R2G	5.0 V	50	DFN10 (Pb-Free)	3000 / Tape & Reel
NCP3335AMNADJR2G	Adj.	ADJ	DFN10 (Pb-Free)	3000 / Tape & Reel

†For information on tape and reel specifications, including part orientation and tape sizes, please refer to our Tape and Reel Packaging Specifications Brochure, BRD8011/D.

*Please contact factory for other voltage options.

NCP3335A

PACKAGE DIMENSIONS

Micro8
CASE 846A-02
ISSUE H

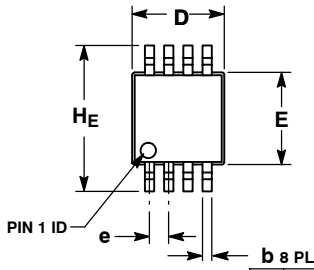

\oplus	0.08 (0.003)	M	T	B	S	A	S
----------	--------------	---	---	---	---	---	---

NOTES:

1. DIMENSIONING AND TOLERANCING PER ANSI Y14.5M, 1982.
2. CONTROLLING DIMENSION: MILLIMETER.
3. DIMENSION A DOES NOT INCLUDE MOLD FLASH, PROTRUSIONS OR GATE BURRS. MOLD FLASH, PROTRUSIONS OR GATE BURRS SHALL NOT EXCEED 0.15 (0.006) PER SIDE.
4. DIMENSION B DOES NOT INCLUDE INTERLEAD FLASH OR PROTRUSION. INTERLEAD FLASH OR PROTRUSION SHALL NOT EXCEED 0.25 (0.010) PER SIDE.
5. 846A-01 OBSOLETE, NEW STANDARD 846A-02.

DIM	MILLIMETERS			INCHES		
	MIN	NOM	MAX	MIN	NOM	MAX
A	--	--	1.10	--	--	0.043
A1	0.05	0.08	0.15	0.002	0.003	0.006
b	0.25	0.33	0.40	0.010	0.013	0.016
c	0.13	0.18	0.23	0.005	0.007	0.009
D	2.90	3.00	3.10	0.114	0.118	0.122
E	2.90	3.00	3.10	0.114	0.118	0.122
e	0.65 BSC			0.026 BSC		
L	0.40	0.55	0.70	0.016	0.021	0.028
HE	4.75	4.90	5.05	0.187	0.193	0.199

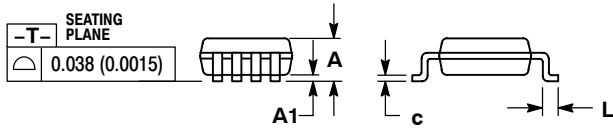

SOLDERING FOOTPRINT*

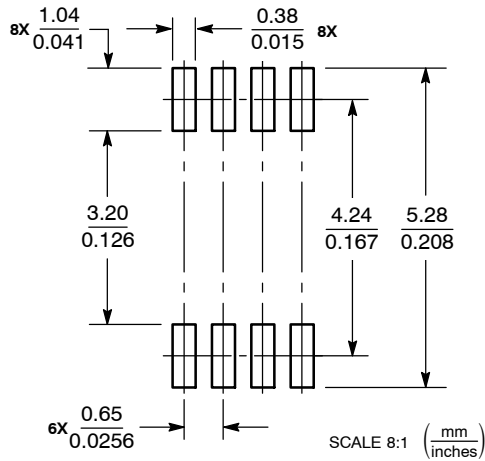

*For additional information on our Pb-Free strategy and soldering details, please download the ON Semiconductor Soldering and Mounting Techniques Reference Manual, SOLDERRM/D.

NCP3335A

PACKAGE DIMENSIONS

DFN10, 3x3, 0.5P
CASE 485C
ISSUE C

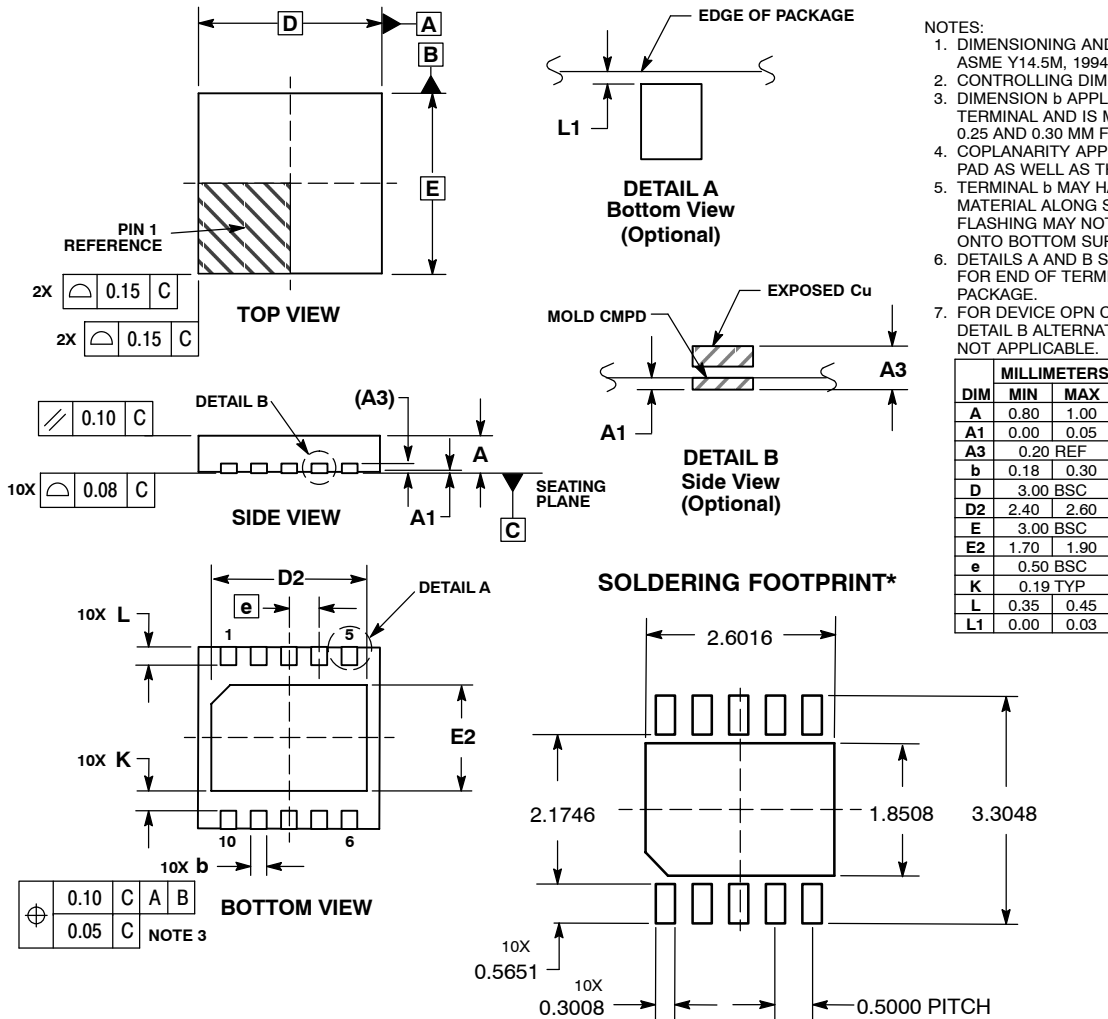

NOTES:

- DIMENSIONING AND TOLERANCING PER ASME Y14.5M, 1994.
- CONTROLLING DIMENSION: MILLIMETERS.
- DIMENSION b APPLIES TO PLATED TERMINAL AND IS MEASURED BETWEEN 0.25 AND 0.30 MM FROM TERMINAL.
- COPLANARITY APPLIES TO THE EXPOSED PAD AS WELL AS THE TERMINALS.
- TERMINAL b MAY HAVE MOLD COMPOUND MATERIAL ALONG SIDE EDGE. MOLD FLASHING MAY NOT EXCEED 30 MICRONS ONTO BOTTOM SURFACE OF TERMINAL b.
- DETAILS A AND B SHOW OPTIONAL VIEWS FOR END OF TERMINAL LEAD AT EDGE OF PACKAGE.
- FOR DEVICE OPN CONTAINING W OPTION, DETAIL B ALTERNATE CONSTRUCTION IS NOT APPLICABLE.

DIMENSIONS: MILLIMETERS
*For additional information on our Pb-Free strategy and soldering details, please download the ON Semiconductor Soldering and Mounting Techniques Reference Manual, SOLDERRM/D.

Micro8 is a trademark of International Rectifier.

ON Semiconductor and are registered trademarks of Semiconductor Components Industries, LLC (SCILLC). SCILLC owns the rights to a number of patents, trademarks, copyrights, trade secrets, and other intellectual property. A listing of SCILLC's product/patent coverage may be accessed at www.onsemi.com/site/pdf/Patent-Marking.pdf. SCILLC reserves the right to make changes without further notice to any products herein. SCILLC makes no warranty, representation or guarantee regarding the suitability of its products for any particular purpose, nor does SCILLC assume any liability arising out of the application or use of any product or circuit, and specifically disclaims any and all liability, including without limitation special, consequential or incidental damages. "Typical" parameters which may be provided in SCILLC data sheets and/or specifications can and do vary in different applications and actual performance may vary over time. All operating parameters, including "Typicals" must be validated for each customer application by customer's technical experts. SCILLC does not convey any license under its patent rights nor the rights of others. SCILLC products are not designed, intended, or authorized for use as components in systems intended for surgical implant into the body, or other applications intended to support or sustain life, or for any other application in which the failure of the SCILLC product could create a situation where personal injury or death may occur. Should Buyer purchase or use SCILLC products for any such unintended or unauthorized application, Buyer shall indemnify and hold SCILLC and its officers, employees, subsidiaries, affiliates, and distributors harmless against all claims, costs, damages, and expenses, and reasonable attorney fees arising out of, directly or indirectly, any claim of personal injury or death associated with such unintended or unauthorized use, even if such claim alleges that SCILLC was negligent regarding the design or manufacture of the part. SCILLC is an Equal Opportunity/Affirmative Action Employer. This literature is subject to all applicable copyright laws and is not for resale in any manner.

PUBLICATION ORDERING INFORMATION

LITERATURE FULFILLMENT:
Literature Distribution Center for ON Semiconductor
P.O. Box 5163, Denver, Colorado 80217 USA
Phone: 303-675-2175 or 800-344-3860 Toll Free USA/Canada
Fax: 303-675-2176 or 800-344-3867 Toll Free USA/Canada
Email: orderlit@onsemi.com

N. American Technical Support: 800-282-9855 Toll Free
USA/Canada
Europe, Middle East and Africa Technical Support:
Phone: 421 33 790 2910
Japan Customer Focus Center
Phone: 81-3-5817-1050

ON Semiconductor Website: www.onsemi.com
Order Literature: <http://www.onsemi.com/orderlit>

For additional information, please contact your local Sales Representative

Looking for pricing, stock, or lifecycle information?

Click below to explore more details on WIN SOURCE:

 [View NCP3335AMNADJR2G on WIN SOURCE](#)

 [ON Semiconductor](#) Information

Optimize Your Supply Chain with WIN SOURCE Solutions

-  Global Sourcing Solution
-  Obsolete Management
-  Cost Control Management
-  Shortage Management
-  Alternative Solution
-  Excess Inventory Management