



**THE DATASHEET OF  
NCP583SQ18T1G**



# NCP583

## Ultra-Low Iq 150 mA CMOS LDO Regulator with Enable

The NCP583 series of low dropout regulators are designed for portable battery powered applications which require precise output voltage accuracy and low quiescent current. These devices feature an enable function which lowers current consumption significantly and are offered in two small packages; SC-82AB and the SOT-563.

A 1.0  $\mu$ F ceramic capacitor is the recommended value to be used with these devices on the output pin.

### Features

- Ultra-Low Dropout Voltage of 250 mV at 150 mA
- Excellent Line Regulation of 0.05%/V
- Excellent Load Regulation of 20 mV
- High Output Voltage Accuracy of  $\pm 2\%$
- Ultra-Low Iq Current of 1.0  $\mu$ A
- Very Low Shutdown Current of 0.1  $\mu$ A
- Wide Output Voltage Range of 1.5 V to 3.3 V
- Low Temperature Drift Coefficient on the Output Voltage of  $\pm 100$  ppm/ $^{\circ}$ C
- Fold Back Protection Circuit
- Input Voltage up to 6.5 V
- These are Pb-Free Devices

### Typical Applications

- Portable Equipment
- Hand-Held Instrumentation
- Camcorders and Cameras

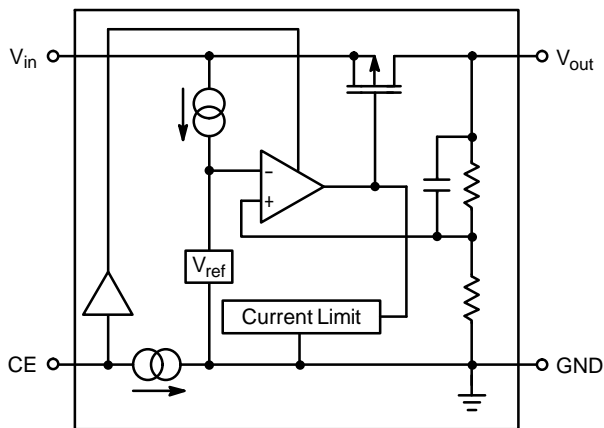

Figure 1. Simplified Block Diagram



ON Semiconductor®

[www.onsemi.com](http://www.onsemi.com)

### MARKING DIAGRAMS

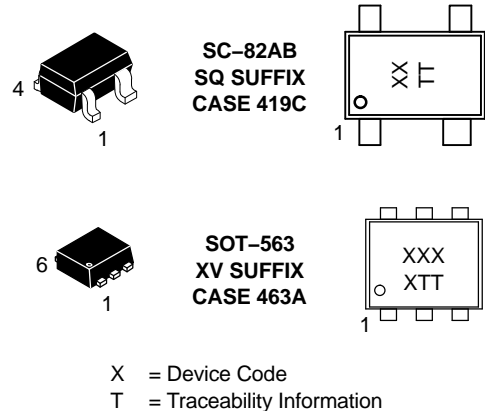

### ORDERING INFORMATION

See detailed ordering and shipping information in the package dimensions section on page 8 of this data sheet.

# NCP583

## PIN FUNCTION DESCRIPTION

| SOT-563 Pin | SC-82AB Pin | Symbol    | Description                 |
|-------------|-------------|-----------|-----------------------------|
| 1           | 4           | $V_{in}$  | Power supply input voltage. |
| 2           | 2           | GND       | Power supply ground.        |
| 3           | 3           | $V_{out}$ | Regulated output voltage.   |
| 4           | –           | NC        | No connect.                 |
| 5           | –           | GND       | Power supply ground.        |
| 6           | 1           | CE        | Chip enable pin.            |

## MAXIMUM RATINGS

| Rating   | Symbol          | Value                  | Unit |
|--|-----------------|------------------------|------|
| Input Voltage  | $V_{in}$        | 6.5                    | V    |
| Input Voltage (CE Pin)   | $V_{CE}$        | 6.5                    | V    |
| Output Voltage   | $V_{out}$       | -0.3 to $V_{in} + 0.3$ | V    |
| Output Current   | $I_{out}$       | 180                    | mA   |
| Thermal Junction Resistance<br>SC-82AB<br>SOT-563                | $R_{\theta JA}$ | 263<br>200             | °C/W |
| ESD Capability, Human Body Model, C = 100 pF, R = 1.5 k $\Omega$ | $ESD_{HBM}$     | 2000                   | V    |
| ESD Capability, Machine Model, C = 200 pF, R = 0 $\Omega$        | $ESD_{MM}$      | 200                    | V    |
| Operating Ambient Temperature Range                              | $T_A$           | -40 to +85             | °C   |
| Maximum Junction Temperature                                     | $T_{J(max)}$    | 125                    | °C   |
| Storage Temperature Range  | $T_{stg}$       | -55 to +150            | °C   |

Stresses exceeding those listed in the Maximum Ratings table may damage the device. If any of these limits are exceeded, device functionality should not be assumed, damage may occur and reliability may be affected.

## ELECTRICAL CHARACTERISTICS ( $V_{in} = V_{out} + 1.0$ V, $T_A = -40^\circ\text{C}$ to $+85^\circ\text{C}$ , unless otherwise noted.)

| Characteristic  | Symbol                           | Min                   | Typ                          | Max                          | Unit          |
|---|----------------------------------|-----------------------|------------------------------|------------------------------|---------------|
| Input Voltage   | $V_{in}$                         | 1.7                   | –                            | 6.0                          | V             |
| Output Voltage ( $1.0 \mu\text{A} \leq I_{out} \leq 30$ mA)   | $V_{out}$                        | $V_{out} \times 0.98$ | –                            | $V_{out} \times 1.02$        | V             |
| Line Regulation ( $I_{out} = 30$ mA)<br>( $V_{out} + 0.5$ V $\leq V_{in} \leq 6.0$ V)   | $Reg_{line}$                     | –                     | 0.05                         | 0.20                         | %/V           |
| Load Regulation ( $1.0 \mu\text{A} \leq I_{out} \leq 150$ mA)   | $Reg_{load}$                     | –                     | 20                           | 40                           | mV            |
| Dropout Voltage ( $I_{out} = 150$ mA)<br>$V_{out} = 1.5$ V<br>$1.7$ V $\leq V_{out} \leq 1.9$ V<br>$2.1$ V $\leq V_{out} \leq 2.7$ V<br>$2.8$ V $\leq V_{out} \leq 3.3$ V | $V_{DO}$                         | –                     | 0.60<br>0.50<br>0.35<br>0.25 | 0.90<br>0.75<br>0.55<br>0.40 | V             |
| Quiescent Current ( $I_{out} = 0$ mA)   | $I_q$                            | –                     | 1.0                          | 1.5                          | $\mu\text{A}$ |
| Output Current  | $I_{out}$                        | 150                   | –                            | –                            | mA            |
| Shutdown Current ( $V_{CE} = \text{Gnd}$ )  | $I_{SD}$                         | –                     | 0.1                          | 1.0                          | $\mu\text{A}$ |
| Output Short Circuit Current ( $V_{out} = 0$ )  | $I_{lim}$                        | –                     | 40                           | –                            | mA            |
| Enable Input Threshold Voltage – High<br>– Low  | $V_{th_{enh}}$<br>$V_{th_{enl}}$ | 1.2<br>0              | –<br>–                       | 6.0<br>0.3                   | V             |
| Output Voltage Temperature Coefficient<br>( $I_{out} = 30$ mA, $-40^\circ\text{C} \leq T_A \leq 85^\circ\text{C}$ )   | $\Delta V_{out}/\Delta T$        | –                     | $\pm 100$                    | –                            | ppm/°C        |

TYPICAL CHARACTERISTICS

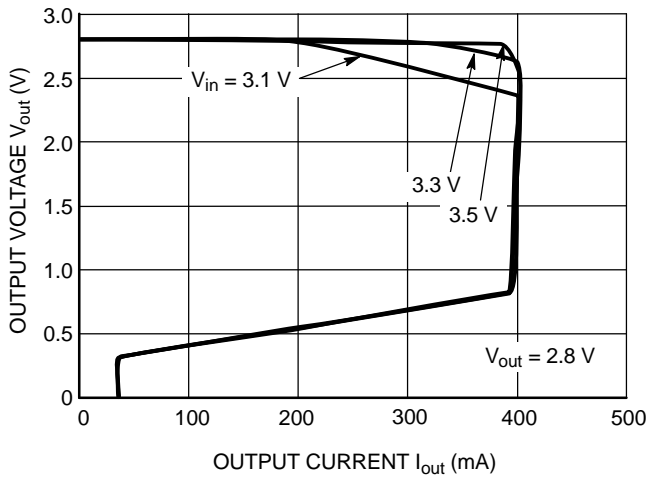

Figure 2. Output Voltage vs. Output Current

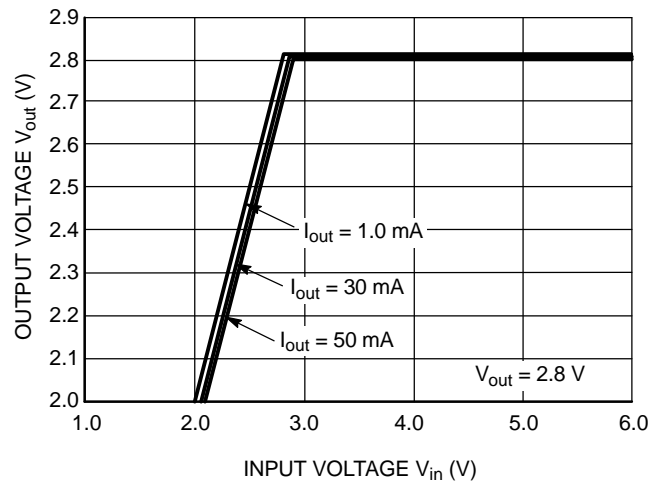

Figure 3. Output Voltage vs. Input Voltage

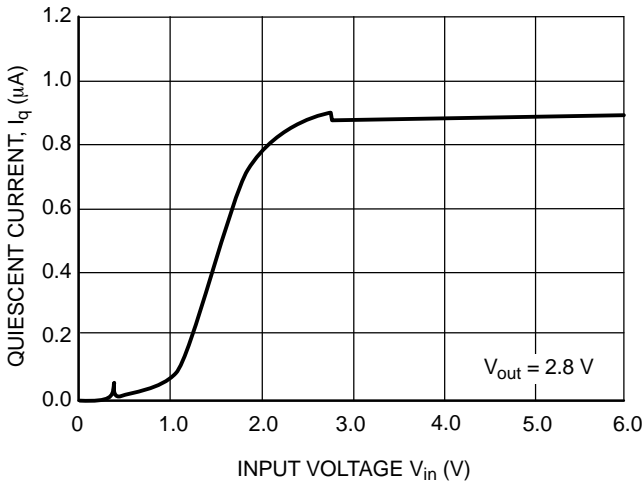

Figure 4. Quiescent Current vs. Input Voltage

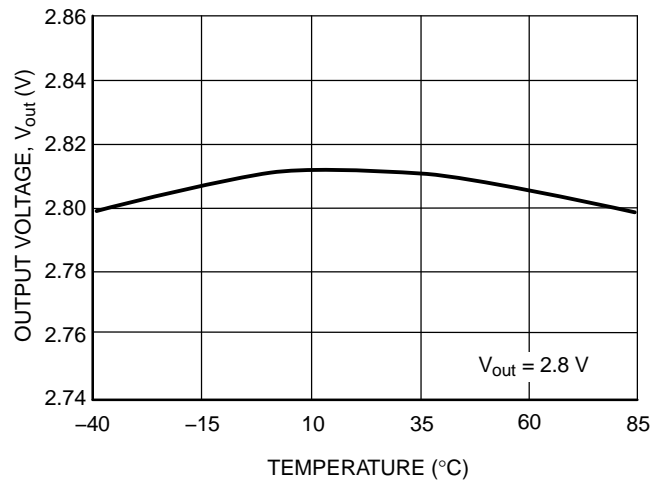

Figure 5. Output Voltage vs. Temperature

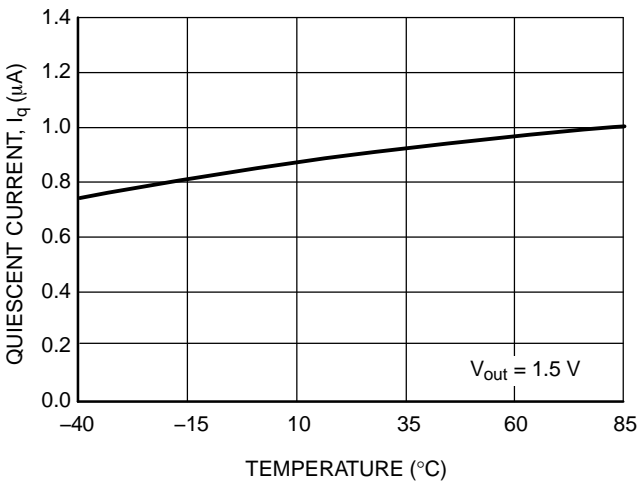

Figure 6. Quiescent Current vs. Temperature

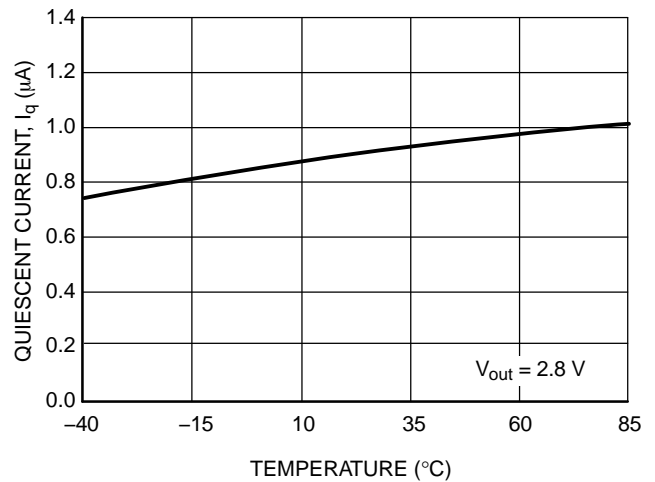

Figure 7. Quiescent Current vs. Temperature

# NCP583

## TYPICAL CHARACTERISTICS

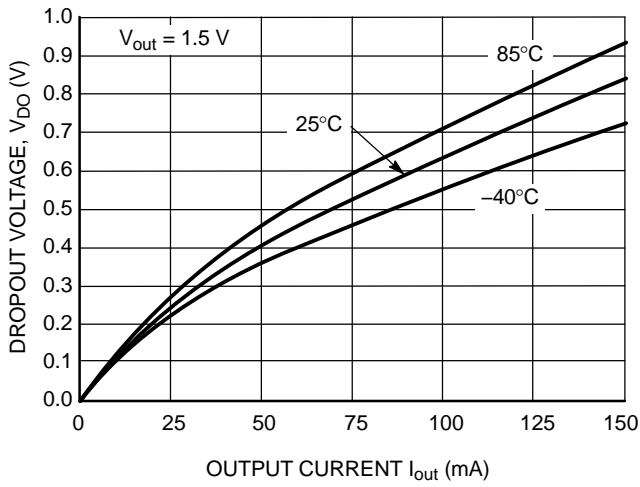

Figure 8. Dropout Voltage vs. Output Current

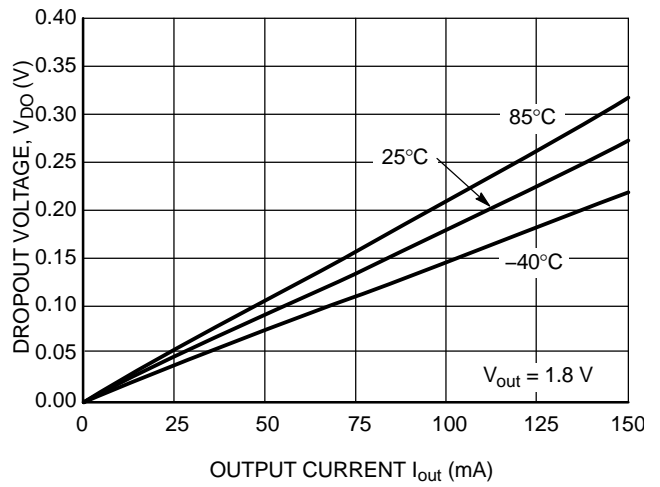

Figure 9. Dropout Voltage vs. Output Current

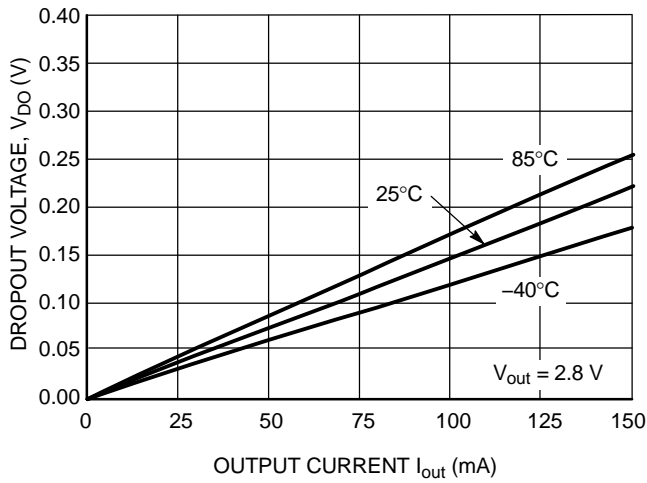

Figure 10. Dropout Voltage vs. Output Current

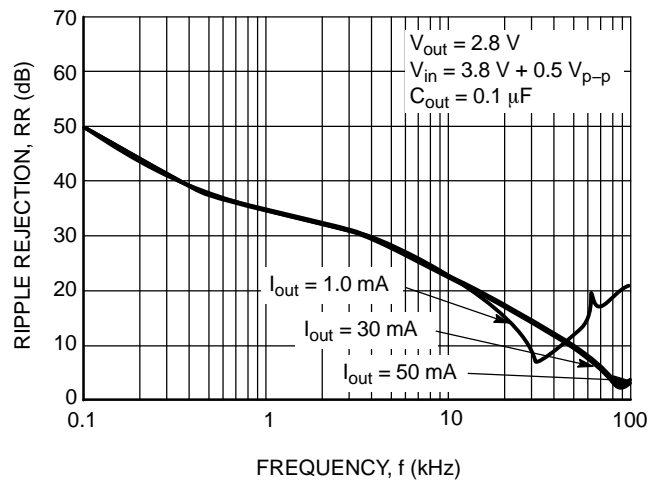

Figure 11. Ripple Rejection vs. Frequency

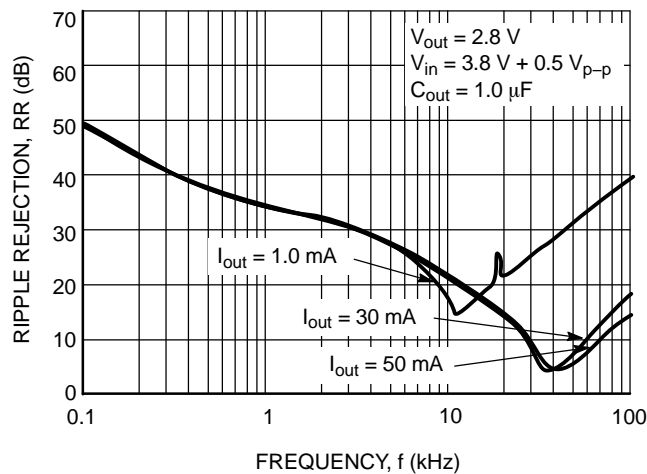
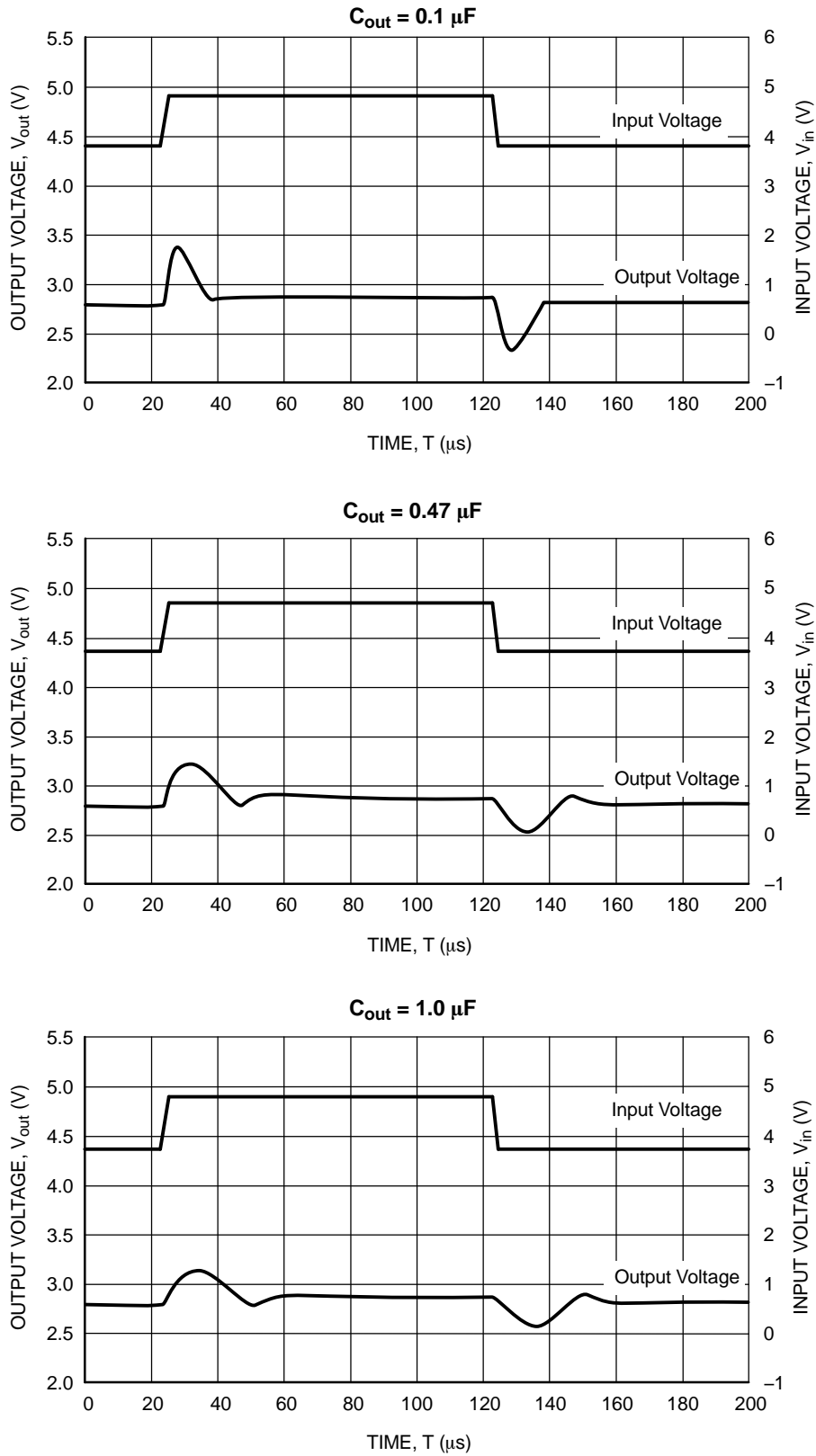

Figure 12. Ripple Rejection vs. Frequency

# NCP583

## TYPICAL CHARACTERISTICS



**Figure 13. Input Transient Response**  
( $V_{out} = 2.8 V$ ,  $I_{out} = 30 mA$ ,  $t_r = t_f = 5.0 \mu s$ ,  $C_{in} = 0$ )

# NCP583

## TYPICAL CHARACTERISTICS

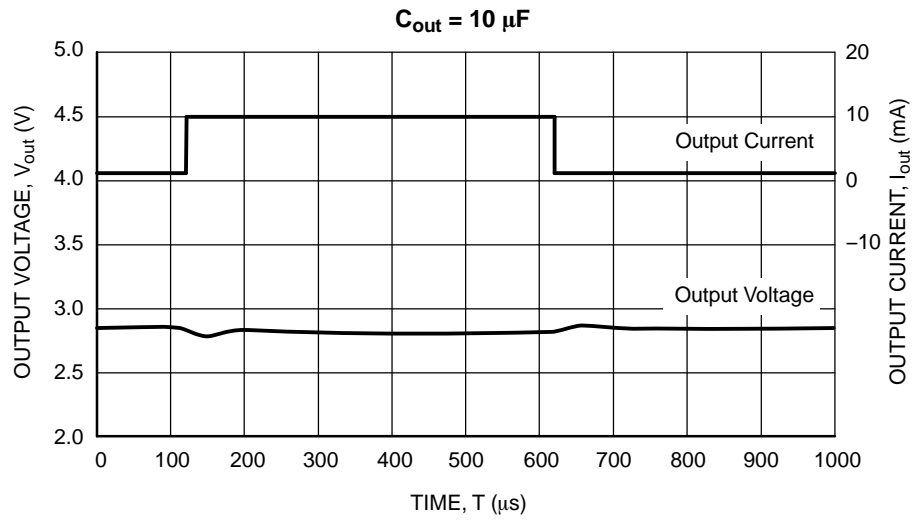
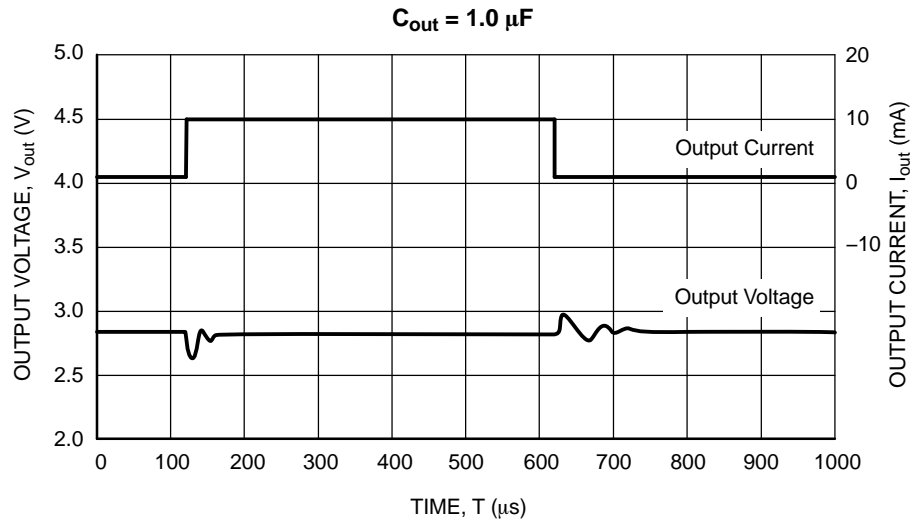

**Figure 14. Load Transient Response**  
( $V_{out} = 2.8$  V,  $t_r = t_f = 5.0 \mu s$ ,  $V_{in} = 3.8$  V)

# NCP583

## TYPICAL CHARACTERISTICS

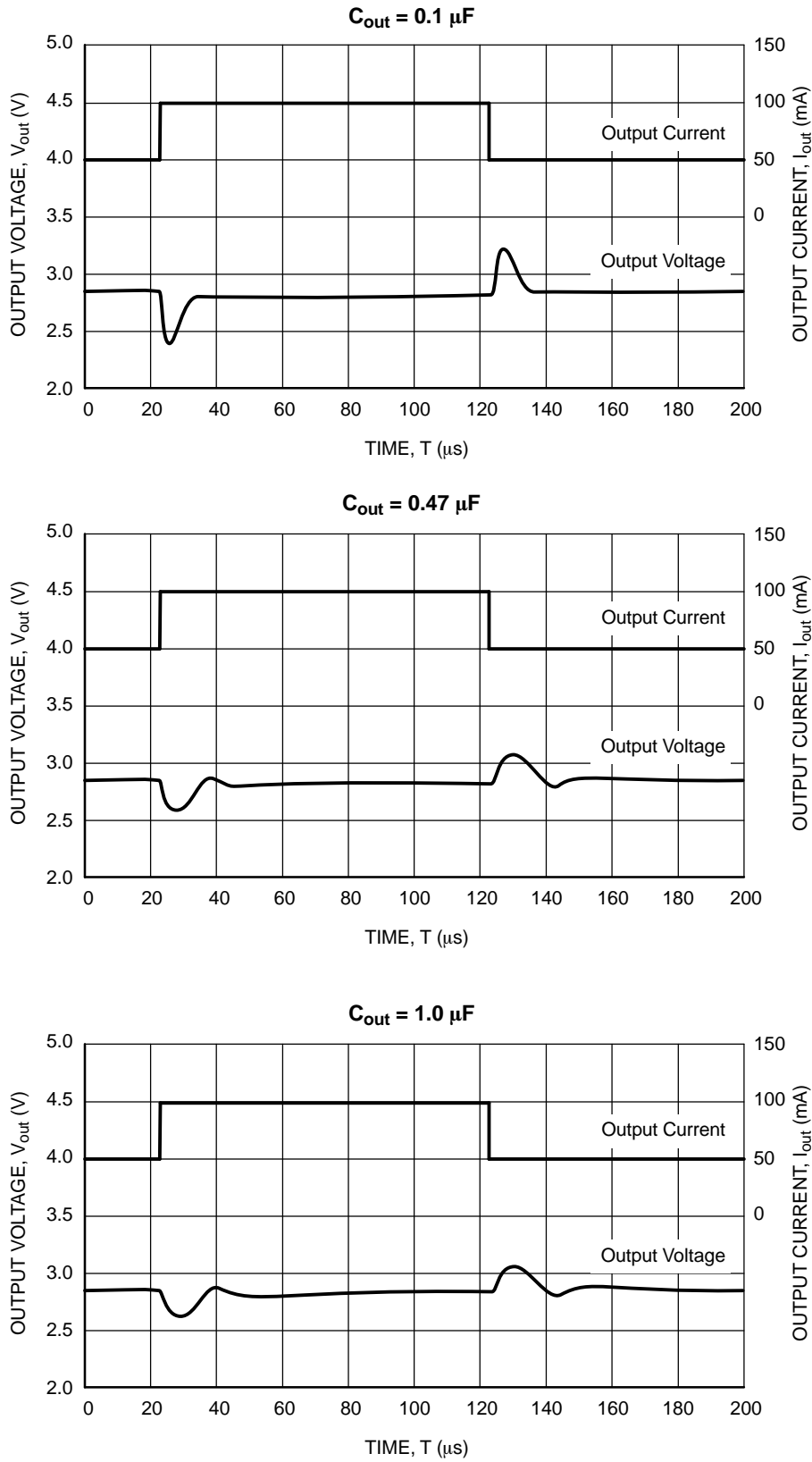

Figure 15. Load Transient Response  
( $V_{\text{out}} = 2.8 \text{ V}$ ,  $t_r = t_f = 5.0 \mu\text{s}$ ,  $V_{\text{in}} = 3.8 \text{ V}$ )

# NCP583

## APPLICATION INFORMATION

### Input Decoupling

A 1.0  $\mu\text{F}$  ceramic capacitor is the recommended value to be connected between  $V_{\text{in}}$  and GND. For PCB layout considerations, the traces of  $V_{\text{in}}$  and GND should be sufficiently wide in order to minimize noise and prevent unstable operation.

### Output Decoupling

It is recommended to use a 0.1  $\mu\text{F}$  ceramic capacitor on the  $V_{\text{out}}$  pin. For better performance, select a capacitor with low Equivalent Series Resistance (ESR). For PCB layout considerations, place the output capacitor close to the output pin and keep the leads short as possible.

## ORDERING INFORMATION

| Device        | Output Type / Features | Nominal Output Voltage | Marking | Package           | Shipping†          |
|---------------|------------------------|------------------------|---------|-------------------|--------------------|
| NCP583SQ15T1G | Active High w/Enable   | 1.5                    | A5      | SC-82AB (Pb-Free) | 3000 / Tape & Reel |
| NCP583SQ18T1G | Active High w/Enable   | 1.8                    | A8      | SC-82AB (Pb-Free) | 3000 / Tape & Reel |
| NCP583SQ25T1G | Active High w/Enable   | 2.5                    | B5      | SC-82AB (Pb-Free) | 3000 / Tape & Reel |
| NCP583SQ27T1G | Active High w/Enable   | 2.7                    | B7      | SC-82AB (Pb-Free) | 3000 / Tape & Reel |
| NCP583SQ28T1G | Active High w/Enable   | 2.8                    | B8      | SC-82AB (Pb-Free) | 3000 / Tape & Reel |
| NCP583SQ30T1G | Active High w/Enable   | 3.0                    | C0      | SC-82AB (Pb-Free) | 3000 / Tape & Reel |
| NCP583SQ33T1G | Active High w/Enable   | 3.3                    | C3      | SC-82AB (Pb-Free) | 3000 / Tape & Reel |
| NCP583XV15T2G | Active High w/Enable   | 1.5                    | G15B    | SOT-563 (Pb-Free) | 4000 / Tape & Reel |
| NCP583XV18T2G | Active High w/Enable   | 1.8                    | G18B    | SOT-563 (Pb-Free) | 4000 / Tape & Reel |
| NCP583XV25T2G | Active High w/Enable   | 2.5                    | G25B    | SOT-563 (Pb-Free) | 4000 / Tape & Reel |
| NCP583XV26T2G | Active High w/Enable   | 2.6                    | G26B    | SOT-563 (Pb-Free) | 4000 / Tape & Reel |
| NCP583XV28T2G | Active High w/Enable   | 2.8                    | G28B    | SOT-563 (Pb-Free) | 4000 / Tape & Reel |
| NCP583XV29T2G | Active High w/Enable   | 2.9                    | G29B    | SOT-563 (Pb-Free) | 4000 / Tape & Reel |
| NCP583XV30T2G | Active High w/Enable   | 3.0                    | G30B    | SOT-563 (Pb-Free) | 4000 / Tape & Reel |
| NCP583XV31T2G | Active High w/Enable   | 3.1                    | G31B    | SOT-563 (Pb-Free) | 4000 / Tape & Reel |
| NCP583XV33T2G | Active High w/Enable   | 3.3                    | G33B    | SOT-563 (Pb-Free) | 4000 / Tape & Reel |

†For information on tape and reel specifications, including part orientation and tape sizes, please refer to our Tape and Reel Packaging Specification Brochure, BRD8011/D.

Other voltages are available. Consult your ON Semiconductor representative.

# NCP583

## PACKAGE DIMENSIONS

SOT-563  
XV SUFFIX  
CASE 463A  
ISSUE G

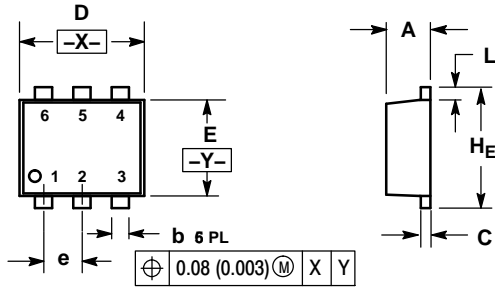

NOTES:

1. DIMENSIONING AND TOLERANCING PER ANSI Y14.5M, 1982.
2. CONTROLLING DIMENSION: MILLIMETERS
3. MAXIMUM LEAD THICKNESS INCLUDES LEAD FINISH THICKNESS. MINIMUM LEAD THICKNESS IS THE MINIMUM THICKNESS OF BASE MATERIAL.

| DIM | MILLIMETERS |      |      | INCHES   |       |       |
|-----|-------------|------|------|----------|-------|-------|
|     | MIN         | NOM  | MAX  | MIN      | NOM   | MAX   |
| A   | 0.50        | 0.55 | 0.60 | 0.020    | 0.021 | 0.023 |
| b   | 0.17        | 0.22 | 0.27 | 0.007    | 0.009 | 0.011 |
| C   | 0.08        | 0.12 | 0.18 | 0.003    | 0.005 | 0.007 |
| D   | 1.50        | 1.60 | 1.70 | 0.059    | 0.062 | 0.066 |
| E   | 1.10        | 1.20 | 1.30 | 0.043    | 0.047 | 0.051 |
| e   | 0.5 BSC     |      |      | 0.02 BSC |       |       |
| L   | 0.10        | 0.20 | 0.30 | 0.004    | 0.008 | 0.012 |
| HE  | 1.50        | 1.60 | 1.70 | 0.059    | 0.062 | 0.066 |

### SOLDERING FOOTPRINT\*

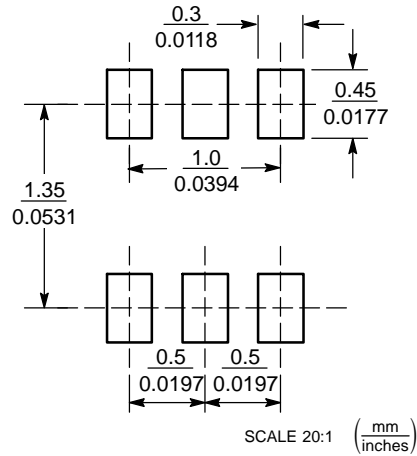

\*For additional information on our Pb-Free strategy and soldering details, please download the ON Semiconductor Soldering and Mounting Techniques Reference Manual, SOLDERRM/D.

# NCP583

## PACKAGE DIMENSIONS

**SC-82AB**  
**SQ SUFFIX**  
 CASE 419C-02  
 ISSUE F

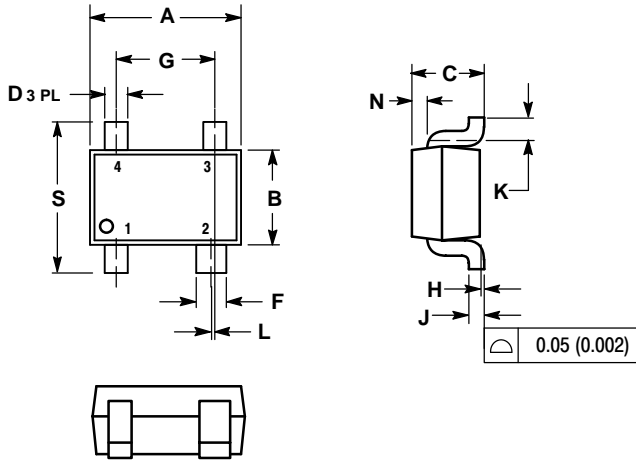

**NOTES:**

1. DIMENSIONING AND TOLERANCING PER ANSI Y14.5M, 1982.
2. CONTROLLING DIMENSION: MILLIMETER.
3. 419C-01 OBSOLETE. NEW STANDARD IS 419C-02.
4. DIMENSIONS A AND B DO NOT INCLUDE MOLD FLASH, PROTRUSIONS, OR GATE BURRS.

| DIM | MILLIMETERS |      | INCHES    |       |
|-----|-------------|------|-----------|-------|
|     | MIN         | MAX  | MIN       | MAX   |
| A   | 1.80        | 2.20 | 0.071     | 0.087 |
| B   | 1.15        | 1.35 | 0.045     | 0.053 |
| C   | 0.80        | 1.10 | 0.031     | 0.043 |
| D   | 0.20        | 0.40 | 0.008     | 0.016 |
| F   | 0.30        | 0.50 | 0.012     | 0.020 |
| G   | 1.10        | 1.50 | 0.043     | 0.059 |
| H   | 0.00        | 0.10 | 0.000     | 0.004 |
| J   | 0.10        | 0.26 | 0.004     | 0.010 |
| K   | 0.10        | ---  | 0.004     | ---   |
| L   | 0.05 BSC    |      | 0.002 BSC |       |
| N   | 0.20 REF    |      | 0.008 REF |       |
| S   | 1.80        | 2.40 | 0.07      | 0.09  |

### SOLDERING FOOTPRINT\*

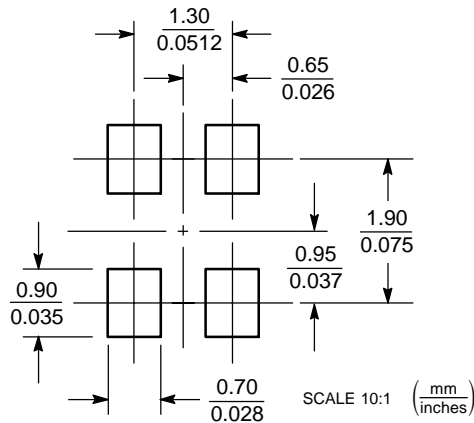

\*For additional information on our Pb-Free strategy and soldering details, please download the ON Semiconductor Soldering and Mounting Techniques Reference Manual, SOLDERRM/D.

ON Semiconductor and the  are registered trademarks of Semiconductor Components Industries, LLC (SCILLC) or its subsidiaries in the United States and/or other countries. SCILLC owns the rights to a number of patents, trademarks, copyrights, trade secrets, and other intellectual property. A listing of SCILLC's product/patent coverage may be accessed at [www.onsemi.com/site/pdf/Patent-Marketing.pdf](http://www.onsemi.com/site/pdf/Patent-Marketing.pdf). SCILLC reserves the right to make changes without further notice to any products herein. SCILLC makes no warranty, representation or guarantee regarding the suitability of its products for any particular purpose, nor does SCILLC assume any liability arising out of the application or use of any product or circuit, and specifically disclaims any and all liability, including without limitation special, consequential or incidental damages. "Typical" parameters which may be provided in SCILLC data sheets and/or specifications can and do vary in different applications and actual performance may vary over time. All operating parameters, including "Typicals" must be validated for each customer application by customer's technical experts. SCILLC does not convey any license under its patent rights nor the rights of others. SCILLC products are not designed, intended, or authorized for use as components in systems intended for surgical implant into the body, or other applications intended to support or sustain life, or for any other application in which the failure of the SCILLC product could create a situation where personal injury or death may occur. Should Buyer purchase or use SCILLC products for any such unintended or unauthorized application, Buyer shall indemnify and hold SCILLC and its officers, employees, subsidiaries, affiliates, and distributors harmless against all claims, costs, damages, and expenses, and reasonable attorney fees arising out of, directly or indirectly, any claim of personal injury or death associated with such unintended or unauthorized use, even if such claim alleges that SCILLC was negligent regarding the design or manufacture of the part. SCILLC is an Equal Opportunity/Affirmative Action Employer. This literature is subject to all applicable copyright laws and is not for resale in any manner.

### PUBLICATION ORDERING INFORMATION

**LITERATURE FULFILLMENT:**  
 Literature Distribution Center for ON Semiconductor  
 19521 E. 32nd Pkwy, Aurora, Colorado 80011 USA  
**Phone:** 303-675-2175 or 800-344-3860 Toll Free USA/Canada  
**Fax:** 303-675-2176 or 800-344-3867 Toll Free USA/Canada  
**Email:** [orderlit@onsemi.com](mailto:orderlit@onsemi.com)

**N. American Technical Support:** 800-282-9855 Toll Free  
 USA/Canada  
**Europe, Middle East and Africa Technical Support:**  
 Phone: 421 33 790 2910  
**Japan Customer Focus Center**  
 Phone: 81-3-5817-1050

**ON Semiconductor Website:** [www.onsemi.com](http://www.onsemi.com)  
**Order Literature:** <http://www.onsemi.com/orderlit>

For additional information, please contact your local Sales Representative

## Looking for pricing, stock, or lifecycle information?

Click below to explore more details on WIN SOURCE:

 [View NCP583SQ18T1G on WIN SOURCE](#)

 [ON Semiconductor](#) Information

## Optimize Your Supply Chain with WIN SOURCE Solutions

-  Global Sourcing Solution
-  Obsolete Management
-  Cost Control Management
-  Shortage Management
-  Alternative Solution
-  Excess Inventory Management