



**THE DATASHEET OF
NCP583XV33T2G**



NCP583

Ultra-Low Iq 150 mA CMOS LDO Regulator with Enable

The NCP583 series of low dropout regulators are designed for portable battery powered applications which require precise output voltage accuracy and low quiescent current. These devices feature an enable function which lowers current consumption significantly and are offered in two small packages; SC-82AB and the SOT-563.

A 1.0 μ F ceramic capacitor is the recommended value to be used with these devices on the output pin.

Features

- Ultra-Low Dropout Voltage of 250 mV at 150 mA
- Excellent Line Regulation of 0.05%/V
- Excellent Load Regulation of 20 mV
- High Output Voltage Accuracy of $\pm 2\%$
- Ultra-Low Iq Current of 1.0 μ A
- Very Low Shutdown Current of 0.1 μ A
- Wide Output Voltage Range of 1.5 V to 3.3 V
- Low Temperature Drift Coefficient on the Output Voltage of ± 100 ppm/ $^{\circ}$ C
- Fold Back Protection Circuit
- Input Voltage up to 6.5 V
- These are Pb-Free Devices

Typical Applications

- Portable Equipment
- Hand-Held Instrumentation
- Camcorders and Cameras

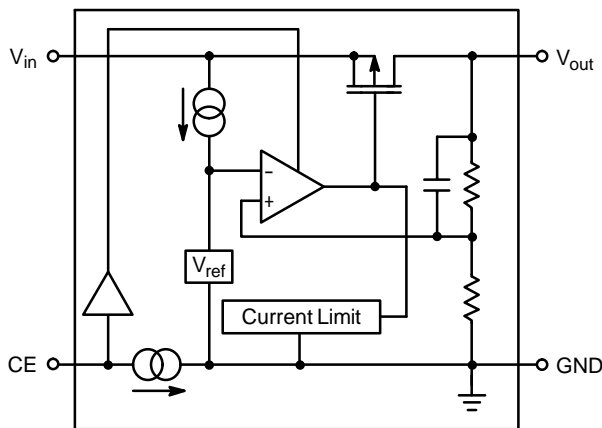

Figure 1. Simplified Block Diagram



ON Semiconductor®

www.onsemi.com

MARKING DIAGRAMS

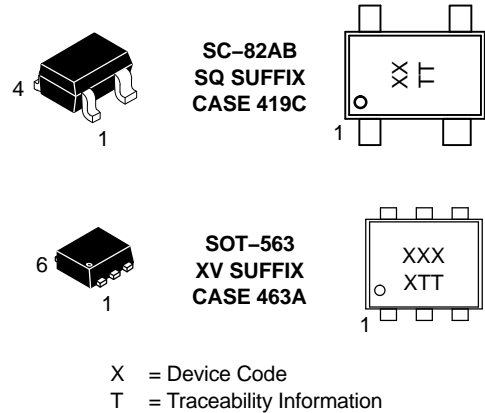

ORDERING INFORMATION

See detailed ordering and shipping information in the package dimensions section on page 8 of this data sheet.

NCP583

PIN FUNCTION DESCRIPTION

SOT-563 Pin	SC-82AB Pin	Symbol	Description
1	4	V_{in}	Power supply input voltage.
2	2	GND	Power supply ground.
3	3	V_{out}	Regulated output voltage.
4	–	NC	No connect.
5	–	GND	Power supply ground.
6	1	CE	Chip enable pin.

MAXIMUM RATINGS

Rating	Symbol	Value	Unit
Input Voltage	V_{in}	6.5	V
Input Voltage (CE Pin)	V_{CE}	6.5	V
Output Voltage	V_{out}	-0.3 to $V_{in} + 0.3$	V
Output Current	I_{out}	180	mA
Thermal Junction Resistance SC-82AB SOT-563	$R_{\theta JA}$	263 200	°C/W
ESD Capability, Human Body Model, C = 100 pF, R = 1.5 k Ω	ESD_{HBM}	2000	V
ESD Capability, Machine Model, C = 200 pF, R = 0 Ω	ESD_{MM}	200	V
Operating Ambient Temperature Range	T_A	-40 to +85	°C
Maximum Junction Temperature	$T_{J(max)}$	125	°C
Storage Temperature Range	T_{stg}	-55 to +150	°C

Stresses exceeding those listed in the Maximum Ratings table may damage the device. If any of these limits are exceeded, device functionality should not be assumed, damage may occur and reliability may be affected.

ELECTRICAL CHARACTERISTICS ($V_{in} = V_{out} + 1.0$ V, $T_A = -40^{\circ}\text{C}$ to $+85^{\circ}\text{C}$, unless otherwise noted.)

Characteristic	Symbol	Min	Typ	Max	Unit
Input Voltage	V_{in}	1.7	–	6.0	V
Output Voltage ($1.0 \mu\text{A} \leq I_{out} \leq 30 \text{ mA}$)	V_{out}	$V_{out} \times 0.98$	–	$V_{out} \times 1.02$	V
Line Regulation ($I_{out} = 30 \text{ mA}$) ($V_{out} + 0.5 \text{ V} \leq V_{in} \leq 6.0 \text{ V}$)	Reg_{line}	–	0.05	0.20	%/V
Load Regulation ($1.0 \mu\text{A} \leq I_{out} \leq 150 \text{ mA}$)	Reg_{load}	–	20	40	mV
Dropout Voltage ($I_{out} = 150 \text{ mA}$) $V_{out} = 1.5 \text{ V}$ $1.7 \text{ V} \leq V_{out} \leq 1.9 \text{ V}$ $2.1 \text{ V} \leq V_{out} \leq 2.7 \text{ V}$ $2.8 \text{ V} \leq V_{out} \leq 3.3 \text{ V}$	V_{DO}	–	0.60 0.50 0.35 0.25	0.90 0.75 0.55 0.40	V
Quiescent Current ($I_{out} = 0 \text{ mA}$)	I_q	–	1.0	1.5	μA
Output Current	I_{out}	150	–	–	mA
Shutdown Current ($V_{CE} = \text{Gnd}$)	I_{SD}	–	0.1	1.0	μA
Output Short Circuit Current ($V_{out} = 0$)	I_{lim}	–	40	–	mA
Enable Input Threshold Voltage – High – Low	$V_{th_{enh}}$ $V_{th_{enl}}$	1.2 0	– –	6.0 0.3	V
Output Voltage Temperature Coefficient ($I_{out} = 30 \text{ mA}$, $-40^{\circ}\text{C} \leq T_A \leq 85^{\circ}\text{C}$)	$\Delta V_{out}/\Delta T$	–	± 100	–	ppm/°C

TYPICAL CHARACTERISTICS

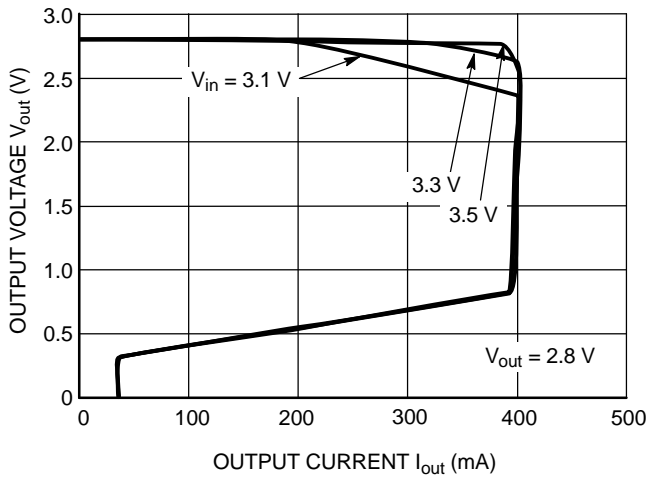

Figure 2. Output Voltage vs. Output Current

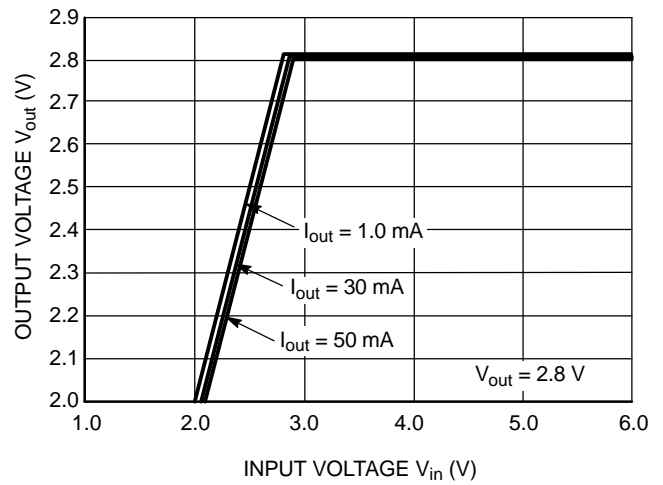

Figure 3. Output Voltage vs. Input Voltage

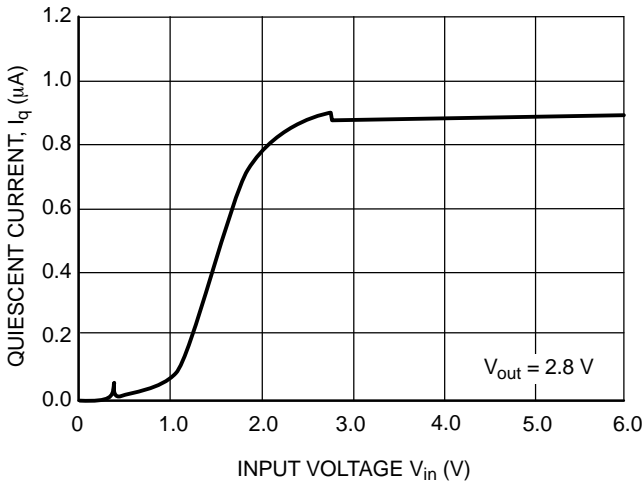

Figure 4. Quiescent Current vs. Input Voltage

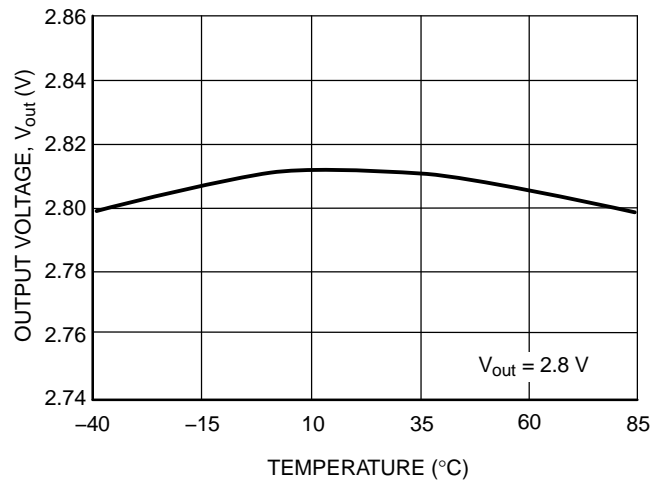

Figure 5. Output Voltage vs. Temperature

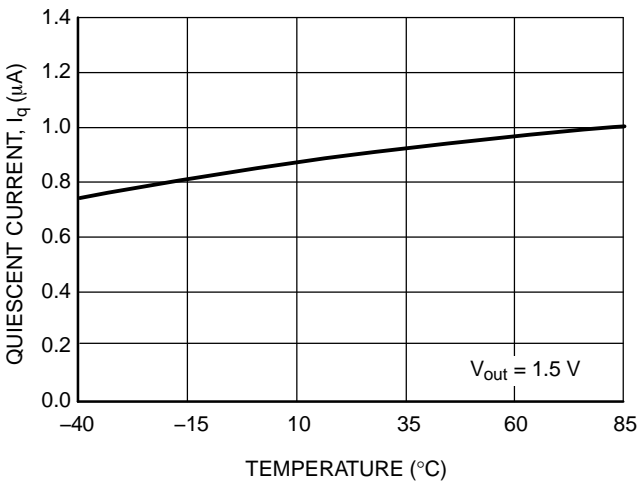

Figure 6. Quiescent Current vs. Temperature

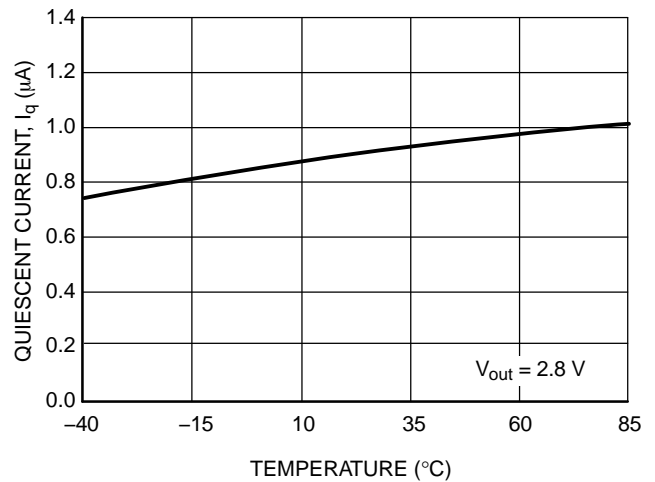

Figure 7. Quiescent Current vs. Temperature

NCP583

TYPICAL CHARACTERISTICS

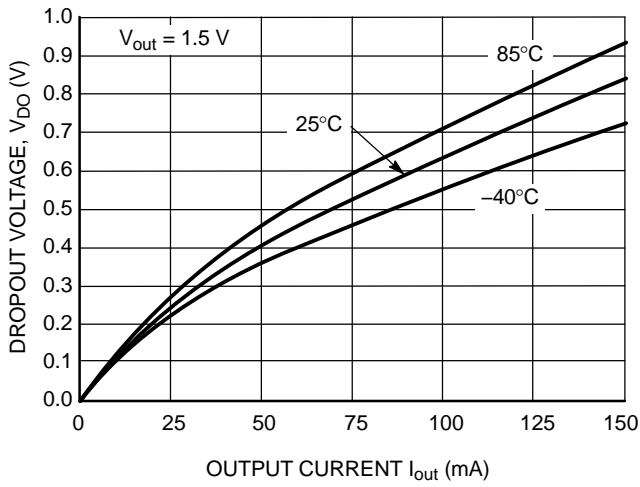

Figure 8. Dropout Voltage vs. Output Current

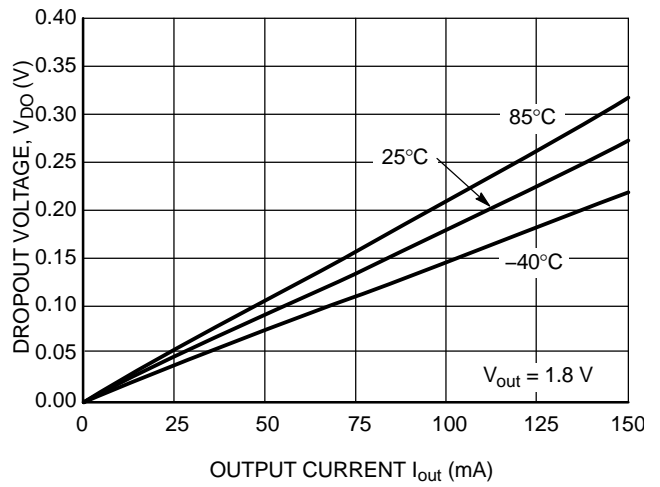

Figure 9. Dropout Voltage vs. Output Current

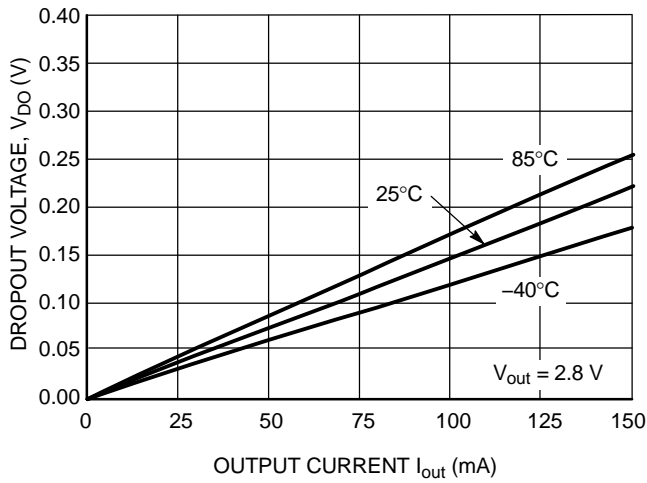

Figure 10. Dropout Voltage vs. Output Current

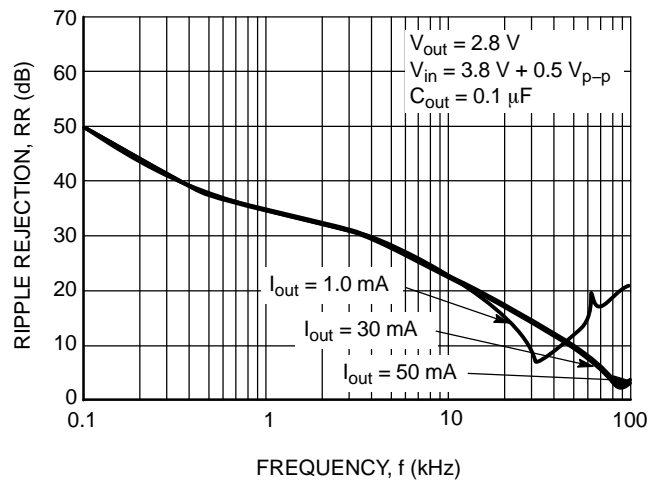

Figure 11. Ripple Rejection vs. Frequency

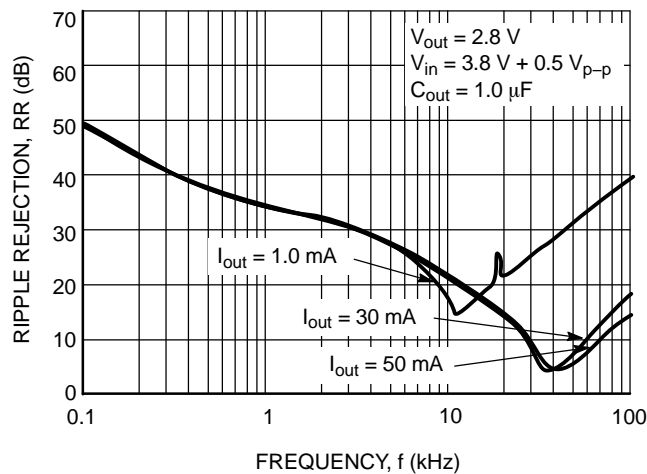

Figure 12. Ripple Rejection vs. Frequency

NCP583

TYPICAL CHARACTERISTICS

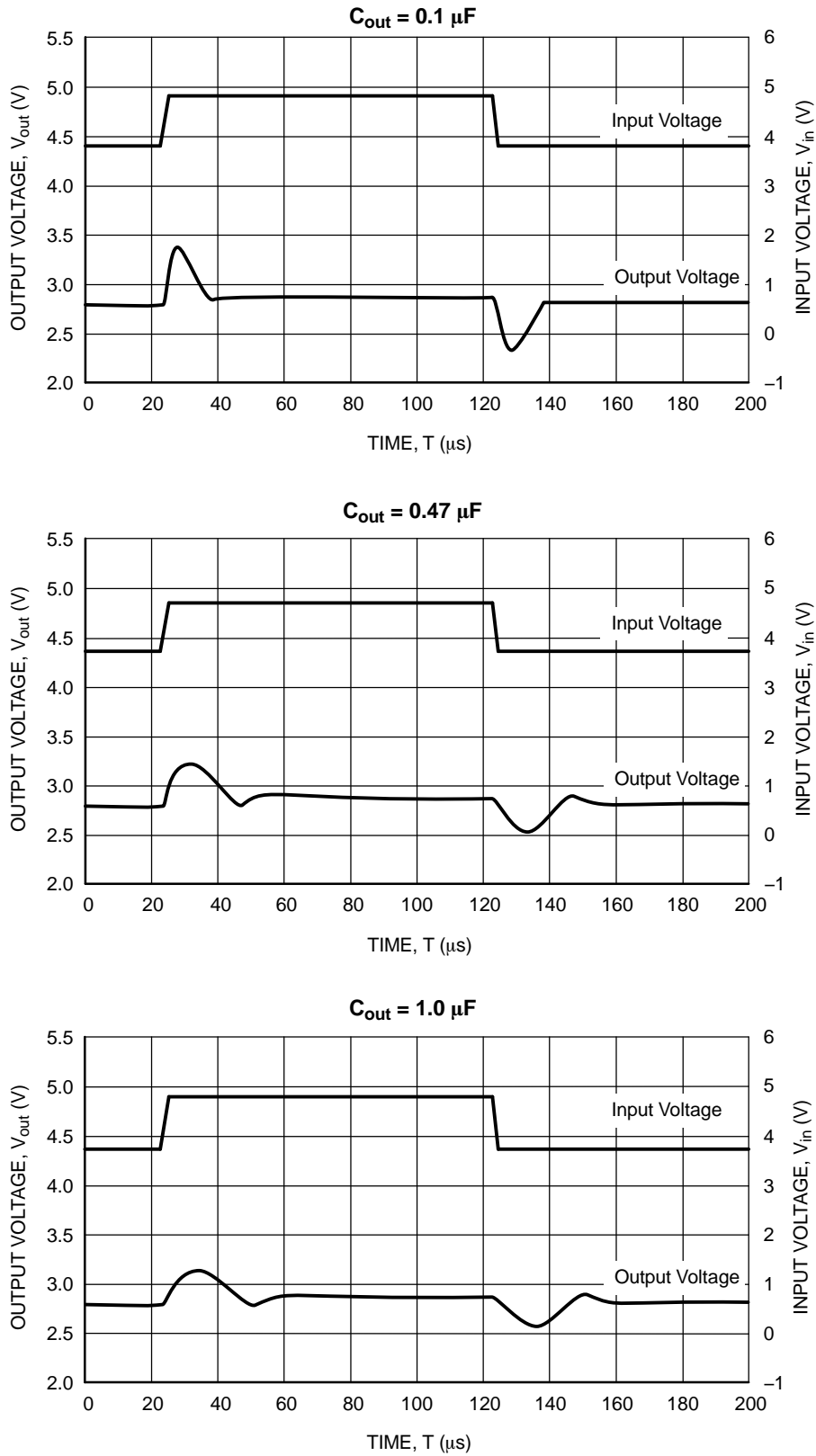

Figure 13. Input Transient Response
($V_{out} = 2.8 V$, $I_{out} = 30 mA$, $t_r = t_f = 5.0 \mu s$, $C_{in} = 0$)

NCP583

TYPICAL CHARACTERISTICS

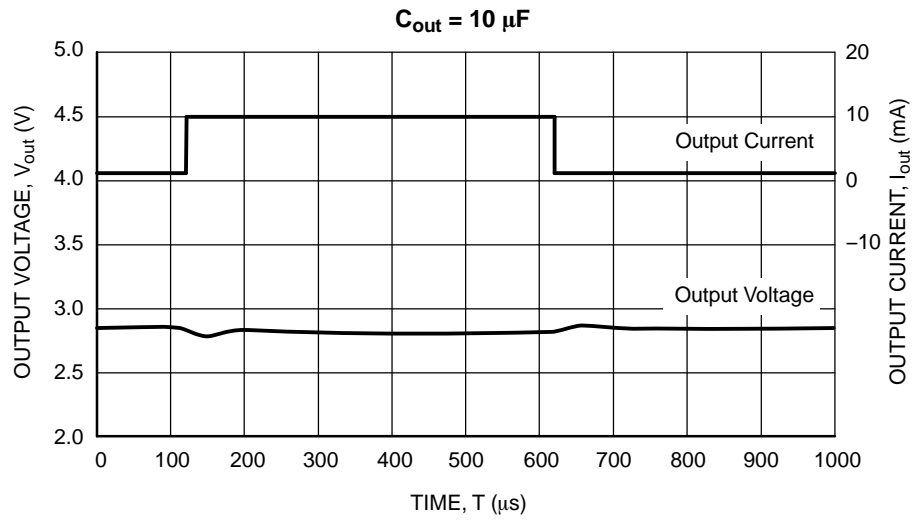
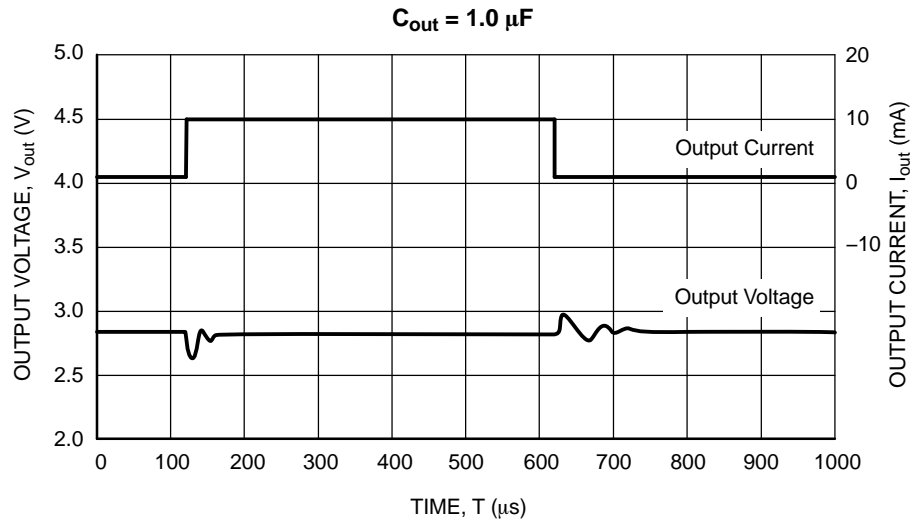

Figure 14. Load Transient Response
($V_{out} = 2.8$ V, $t_r = t_f = 5.0 \mu s$, $V_{in} = 3.8$ V)

NCP583

TYPICAL CHARACTERISTICS

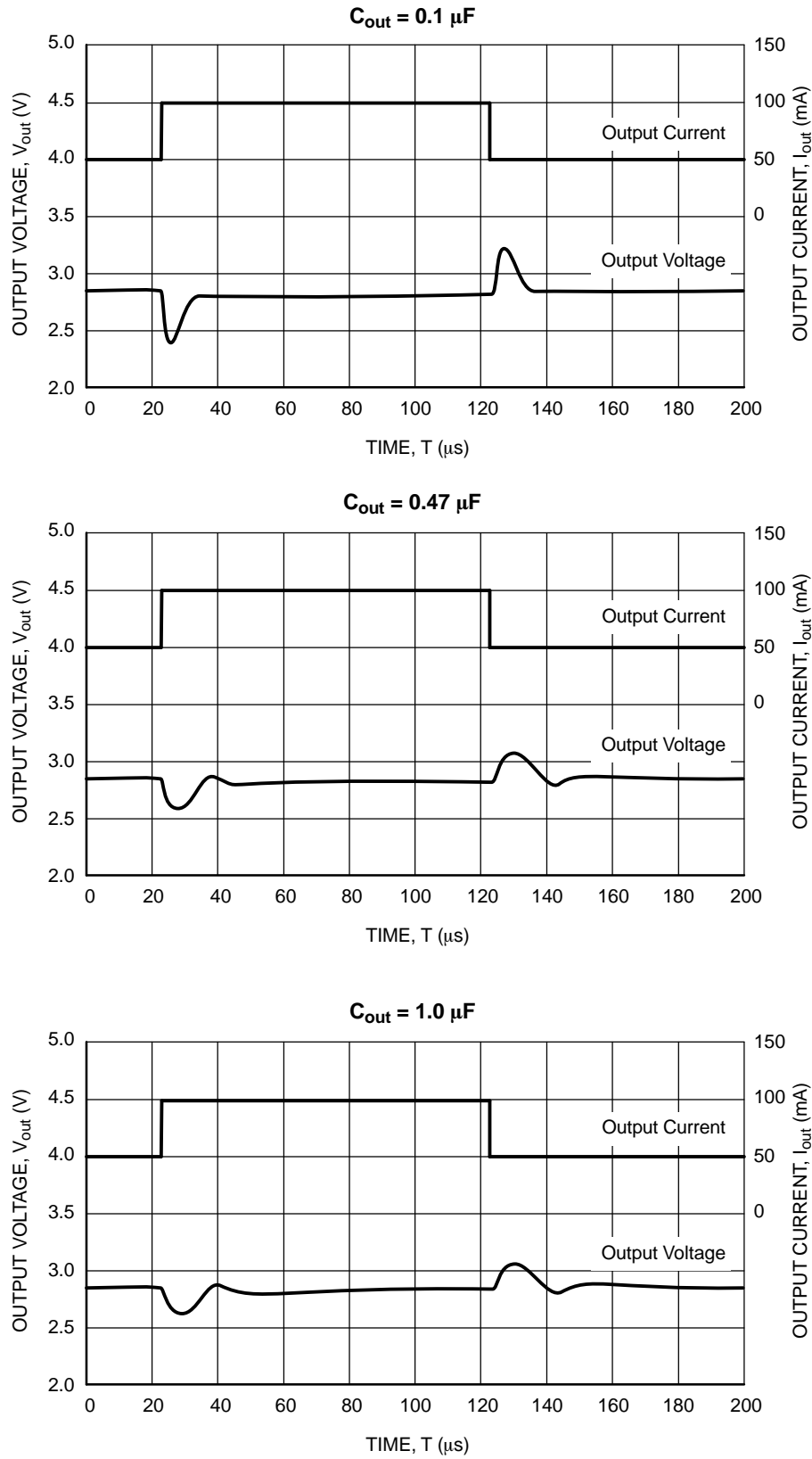

Figure 15. Load Transient Response
($V_{out} = 2.8 V$, $t_r = t_f = 5.0 \mu s$, $V_{in} = 3.8 V$)

NCP583

APPLICATION INFORMATION

Input Decoupling

A 1.0 μF ceramic capacitor is the recommended value to be connected between V_{in} and GND. For PCB layout considerations, the traces of V_{in} and GND should be sufficiently wide in order to minimize noise and prevent unstable operation.

Output Decoupling

It is recommended to use a 0.1 μF ceramic capacitor on the V_{out} pin. For better performance, select a capacitor with low Equivalent Series Resistance (ESR). For PCB layout considerations, place the output capacitor close to the output pin and keep the leads short as possible.

ORDERING INFORMATION

Device	Output Type / Features	Nominal Output Voltage	Marking	Package	Shipping†
NCP583SQ15T1G	Active High w/Enable	1.5	A5	SC-82AB (Pb-Free)	3000 / Tape & Reel
NCP583SQ18T1G	Active High w/Enable	1.8	A8	SC-82AB (Pb-Free)	3000 / Tape & Reel
NCP583SQ25T1G	Active High w/Enable	2.5	B5	SC-82AB (Pb-Free)	3000 / Tape & Reel
NCP583SQ27T1G	Active High w/Enable	2.7	B7	SC-82AB (Pb-Free)	3000 / Tape & Reel
NCP583SQ28T1G	Active High w/Enable	2.8	B8	SC-82AB (Pb-Free)	3000 / Tape & Reel
NCP583SQ30T1G	Active High w/Enable	3.0	C0	SC-82AB (Pb-Free)	3000 / Tape & Reel
NCP583SQ33T1G	Active High w/Enable	3.3	C3	SC-82AB (Pb-Free)	3000 / Tape & Reel
NCP583XV15T2G	Active High w/Enable	1.5	G15B	SOT-563 (Pb-Free)	4000 / Tape & Reel
NCP583XV18T2G	Active High w/Enable	1.8	G18B	SOT-563 (Pb-Free)	4000 / Tape & Reel
NCP583XV25T2G	Active High w/Enable	2.5	G25B	SOT-563 (Pb-Free)	4000 / Tape & Reel
NCP583XV26T2G	Active High w/Enable	2.6	G26B	SOT-563 (Pb-Free)	4000 / Tape & Reel
NCP583XV28T2G	Active High w/Enable	2.8	G28B	SOT-563 (Pb-Free)	4000 / Tape & Reel
NCP583XV29T2G	Active High w/Enable	2.9	G29B	SOT-563 (Pb-Free)	4000 / Tape & Reel
NCP583XV30T2G	Active High w/Enable	3.0	G30B	SOT-563 (Pb-Free)	4000 / Tape & Reel
NCP583XV31T2G	Active High w/Enable	3.1	G31B	SOT-563 (Pb-Free)	4000 / Tape & Reel
NCP583XV33T2G	Active High w/Enable	3.3	G33B	SOT-563 (Pb-Free)	4000 / Tape & Reel

†For information on tape and reel specifications, including part orientation and tape sizes, please refer to our Tape and Reel Packaging Specification Brochure, BRD8011/D.

Other voltages are available. Consult your ON Semiconductor representative.

NCP583

PACKAGE DIMENSIONS

SOT-563
XV SUFFIX
CASE 463A
ISSUE G

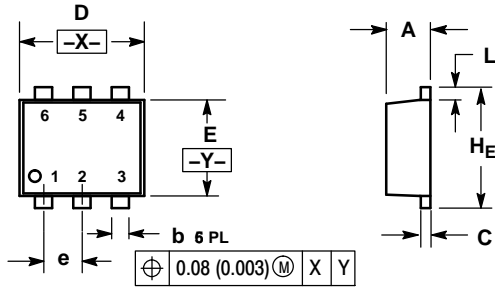

NOTES:

1. DIMENSIONING AND TOLERANCING PER ANSI Y14.5M, 1982.
2. CONTROLLING DIMENSION: MILLIMETERS
3. MAXIMUM LEAD THICKNESS INCLUDES LEAD FINISH THICKNESS. MINIMUM LEAD THICKNESS IS THE MINIMUM THICKNESS OF BASE MATERIAL.

DIM	MILLIMETERS			INCHES		
	MIN	NOM	MAX	MIN	NOM	MAX
A	0.50	0.55	0.60	0.020	0.021	0.023
b	0.17	0.22	0.27	0.007	0.009	0.011
C	0.08	0.12	0.18	0.003	0.005	0.007
D	1.50	1.60	1.70	0.059	0.062	0.066
E	1.10	1.20	1.30	0.043	0.047	0.051
e	0.5 BSC			0.02 BSC		
L	0.10	0.20	0.30	0.004	0.008	0.012
HE	1.50	1.60	1.70	0.059	0.062	0.066

SOLDERING FOOTPRINT*

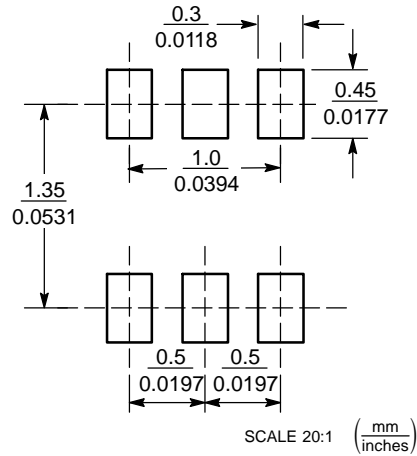

SCALE 20:1 $\left(\frac{\text{mm}}{\text{inches}}\right)$

*For additional information on our Pb-Free strategy and soldering details, please download the ON Semiconductor Soldering and Mounting Techniques Reference Manual, SOLDERRM/D.

NCP583

PACKAGE DIMENSIONS

SC-82AB
SQ SUFFIX
 CASE 419C-02
 ISSUE F

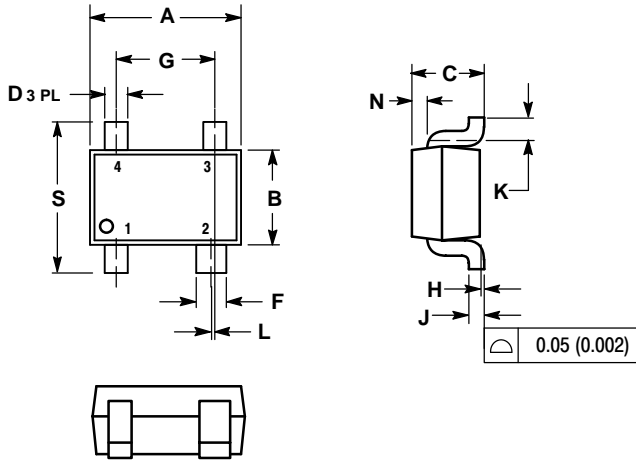

NOTES:

1. DIMENSIONING AND TOLERANCING PER ANSI Y14.5M, 1982.
2. CONTROLLING DIMENSION: MILLIMETER.
3. 419C-01 OBSOLETE. NEW STANDARD IS 419C-02.
4. DIMENSIONS A AND B DO NOT INCLUDE MOLD FLASH, PROTRUSIONS, OR GATE BURRS.

DIM	MILLIMETERS		INCHES	
	MIN	MAX	MIN	MAX
A	1.80	2.20	0.071	0.087
B	1.15	1.35	0.045	0.053
C	0.80	1.10	0.031	0.043
D	0.20	0.40	0.008	0.016
F	0.30	0.50	0.012	0.020
G	1.10	1.50	0.043	0.059
H	0.00	0.10	0.000	0.004
J	0.10	0.26	0.004	0.010
K	0.10	---	0.004	---
L	0.05 BSC		0.002 BSC	
N	0.20 REF		0.008 REF	
S	1.80	2.40	0.07	0.09

SOLDERING FOOTPRINT*

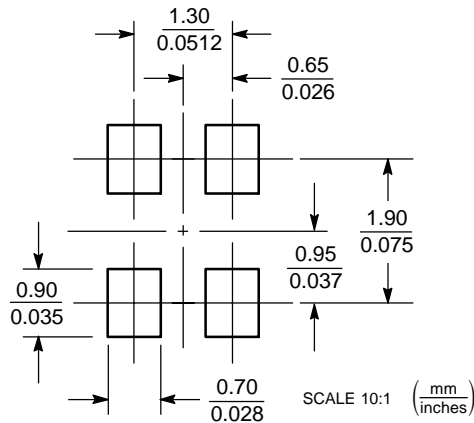

*For additional information on our Pb-Free strategy and soldering details, please download the ON Semiconductor Soldering and Mounting Techniques Reference Manual, SOLDERRM/D.

ON Semiconductor and the are registered trademarks of Semiconductor Components Industries, LLC (SCILLC) or its subsidiaries in the United States and/or other countries. SCILLC owns the rights to a number of patents, trademarks, copyrights, trade secrets, and other intellectual property. A listing of SCILLC's product/patent coverage may be accessed at www.onsemi.com/site/pdf/Patent-Marking.pdf. SCILLC reserves the right to make changes without further notice to any products herein. SCILLC makes no warranty, representation or guarantee regarding the suitability of its products for any particular purpose, nor does SCILLC assume any liability arising out of the application or use of any product or circuit, and specifically disclaims any and all liability, including without limitation special, consequential or incidental damages. "Typical" parameters which may be provided in SCILLC data sheets and/or specifications can and do vary in different applications and actual performance may vary over time. All operating parameters, including "Typicals" must be validated for each customer application by customer's technical experts. SCILLC does not convey any license under its patent rights nor the rights of others. SCILLC products are not designed, intended, or authorized for use as components in systems intended for surgical implant into the body, or other applications intended to support or sustain life, or for any other application in which the failure of the SCILLC product could create a situation where personal injury or death may occur. Should Buyer purchase or use SCILLC products for any such unintended or unauthorized application, Buyer shall indemnify and hold SCILLC and its officers, employees, subsidiaries, affiliates, and distributors harmless against all claims, costs, damages, and expenses, and reasonable attorney fees arising out of, directly or indirectly, any claim of personal injury or death associated with such unintended or unauthorized use, even if such claim alleges that SCILLC was negligent regarding the design or manufacture of the part. SCILLC is an Equal Opportunity/Affirmative Action Employer. This literature is subject to all applicable copyright laws and is not for resale in any manner.

PUBLICATION ORDERING INFORMATION

LITERATURE FULFILLMENT:
 Literature Distribution Center for ON Semiconductor
 19521 E. 32nd Pkwy, Aurora, Colorado 80011 USA
Phone: 303-675-2175 or 800-344-3860 Toll Free USA/Canada
Fax: 303-675-2176 or 800-344-3867 Toll Free USA/Canada
Email: orderlit@onsemi.com

N. American Technical Support: 800-282-9855 Toll Free
 USA/Canada
Europe, Middle East and Africa Technical Support:
 Phone: 421 33 790 2910
Japan Customer Focus Center
 Phone: 81-3-5817-1050

ON Semiconductor Website: www.onsemi.com
Order Literature: <http://www.onsemi.com/orderlit>

For additional information, please contact your local Sales Representative

Looking for pricing, stock, or lifecycle information?

Click below to explore more details on WIN SOURCE:

 [View NCP583XV33T2G on WIN SOURCE](#)

 [ON Semiconductor](#) Information

Optimize Your Supply Chain with WIN SOURCE Solutions

-  Global Sourcing Solution
-  Obsolete Management
-  Cost Control Management
-  Shortage Management
-  Alternative Solution
-  Excess Inventory Management