



**THE DATASHEET OF  
NCP631GD2TR4**



# NCP631

## 3.0 A Linear Voltage Regulator with Soft-Start

The NCP631 is a low dropout positive voltage regulator that is capable of providing a guaranteed output current of 3.0 A with a maximum dropout voltage of 1.25 V at 3.0 A over temperature. The NCP631 is currently offered as a fixed voltage version at 3.47 V. On chip trimming adjusts the reference/output voltage to within  $\pm 1.5\%$  accuracy. The Soft-Start function allows control of start up times. This prevents current spikes at start up due to output capacitor in-rush current. Internal protection features consist of output foldback current limiting, and thermal shutdown. The NCP631 is available in D<sup>2</sup>PAK package.

### Features

- Output Current of 3.0 A
- 1.25 V Maximum Dropout Voltage at 3.0 A Over Temperature
- Voltage on Shutdown Pin is TTL compatible
- Reference/Output Voltage Trimmed to  $\pm 1.5\%$
- Current Limit Protection
- Thermal Shutdown Protection
- 0°C to 125°C Junction Temperature Range
- Pb-Free Packages are Available

### Applications

- Microprocessor Power Supplies
- SMPS Post Regulation
- Battery Chargers
- DSP Power Supplies

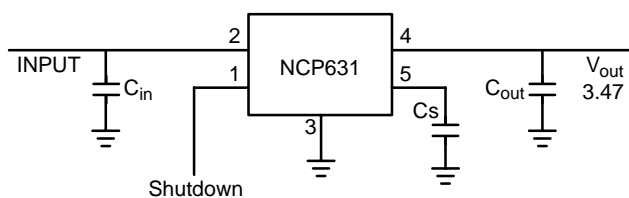
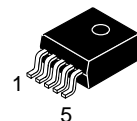

Figure 1. Typical Application Circuit



ON Semiconductor®

<http://onsemi.com>



D<sup>2</sup>PAK  
D2T SUFFIX  
CASE 936A

Tab = Ground  
Pin 1. Shutdown  
2.  $V_{in}$   
3. Ground  
4.  $V_{out}$   
5. Soft-Start

### MARKING DIAGRAM

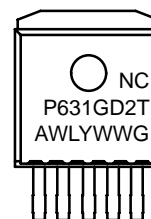

NCP631GD2T = Device Code  
A = Assembly Location  
WL = Wafer Lot  
Y = Year  
WW = Work Week  
G = Pb-Free Package

### ORDERING INFORMATION

Device	Package	Shipping†
NCP631GD2TR4	D <sup>2</sup> PAK	800/Tape & Reel
NCP631GD2TR4G	D <sup>2</sup> PAK (Pb-Free)	800/Tape & Reel
NCP631GD2T	D <sup>2</sup> PAK	50 Units / Tube
NCP631GD2TG	D <sup>2</sup> PAK (Pb-Free)	50 Units / Tube

†For information on tape and reel specifications, including part orientation and tape sizes, please refer to our Tape and Reel Packaging Specifications Brochure, BRD8011/D.

# NCP631

## PIN DESCRIPTION

Pin No.	Symbol	Description
1	Shutdown	This input is used to place the NCP631 into shutdown mode. The NCP631 is active when a voltage greater than 2.0 V is applied. The NCP631 will be placed into a shutdown mode when a voltage less than 0.8 V is applied. If left unused then connect the pin high.
2	$V_{in}$	Positive Power Supply Input Voltage
3, Tab	Ground	Power Supply Ground
4	$V_{out}$	Regulated Output Voltage
5	Soft-Start	Soft-Start capacitor is placed from this pin to ground. Refer to applications information section on Page 6 for proper capacitor selection.

## MAXIMUM RATINGS

Rating	Symbol	Value	Unit
Input Voltage (Note 1)	$V_{in}$	9.0	V
Shutdown Voltage	Enable	-0.3 to 7	V
Output Voltage	$V_{out}$	-0.3 to $V_{in} + 0.3$	V
Power Dissipation and Thermal Characteristics Case 936A (D <sup>2</sup> PAK)			
Power Dissipation (Note 2)	$P_D$	Internally Limited	W
Thermal Resistance, Junction-to-Ambient	$R_{\theta JA}$	45	°C/W
Thermal Resistance, Junction-to-Case	$R_{\theta JC}$	5.0	°C/W
Operating Junction Temperature Range	$T_J$	-40 to 125	°C
Storage Temperature Range	$T_{stg}$	-55 to 150	°C

Stresses exceeding Maximum Ratings may damage the device. Maximum Ratings are stress ratings only. Functional operation above the Recommended Operating Conditions is not implied. Extended exposure to stresses above the Recommended Operating Conditions may affect device reliability.

- This device series contains ESD protection and exceeds the following tests:  
Human Body Model JESD 22-A114-B  
Machine Model JESD 22-A115-A

- The maximum package power dissipation is:

$$PD = \frac{T_J(\max) - T_A}{R_{\theta JA}}$$

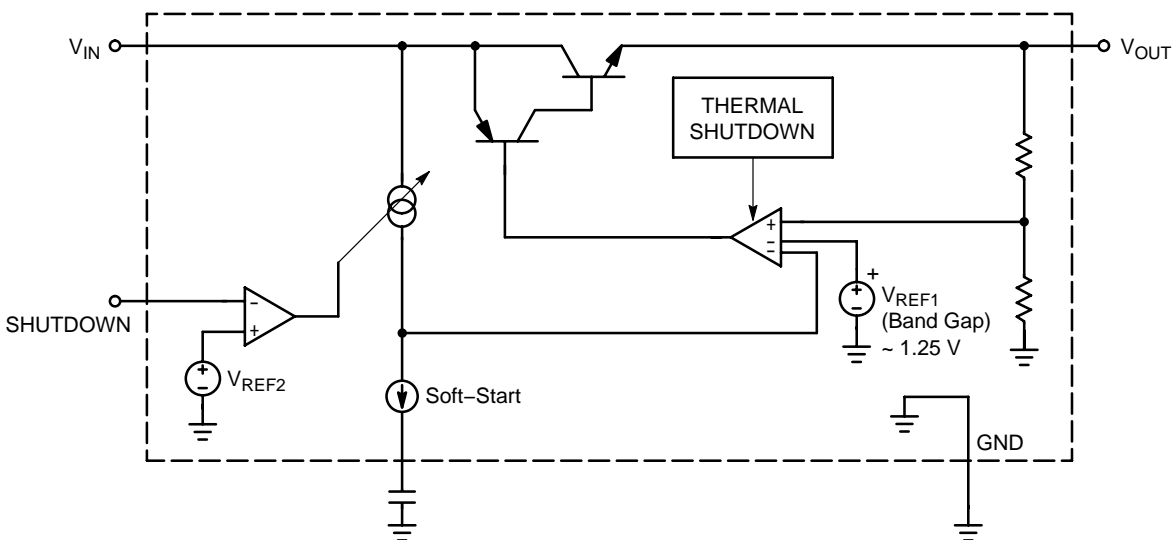

Figure 2. Simplified Block Diagram

# NCP631

**ELECTRICAL CHARACTERISTICS** ( $C_{in} = 68 \mu\text{F}$ ,  $C_{out} = 47 + 470 \mu\text{F}$ ,  $V_{in} = V_{out} + 1.5 \text{ V}$ ,  $I_{out} = 10 \text{ mA}$ , for typical value  $T_J = 25^\circ\text{C}$ , for min and max values  $T_J = 0^\circ\text{C}$  to  $125^\circ\text{C}$  unless otherwise noted.)

Characteristic	Symbol	Min	Typ	Max	Unit
Output Voltage ( $V_{in} = 5.0 \text{ V}$ to $7.0 \text{ V}$ , $I_{out} = 10 \text{ mA}$ to $3.0 \text{ A}$ , $T_J = 25^\circ\text{C}$ ) ( $V_{in} = 5.0 \text{ V}$ to $7.0 \text{ V}$ , $I_{out} = 10 \text{ mA}$ to $3.0 \text{ A}$ , $T_J = 0^\circ\text{C}$ to $125^\circ\text{C}$ )	$V_{adj}$	3.418 3.383	3.470 –	3.522 3.557	V
Line Regulation ( $T_J = 25^\circ\text{C}$ ) (Note 3) ( $V_{in} = V_{out} + 1.5 \text{ V}$ to $7.0 \text{ V}$ ) ( $V_{in} = V_{out} + 1.5 \text{ V}$ to $7.0 \text{ V}$ , $T_J = 0^\circ\text{C}$ to $125^\circ\text{C}$ )	$\text{Reg}_{line}$	– –	0.02 0.06	– –	%
Load Regulation ( $T_J = 25^\circ\text{C}$ ) (Note 3) ( $I_{out} = 10 \text{ mA}$ to $3.0 \text{ A}$ , $T_J = 25^\circ\text{C}$ ) ( $I_{out} = 10 \text{ mA}$ to $3.0 \text{ A}$ , $T_J = 0^\circ\text{C}$ to $125^\circ\text{C}$ )	$\text{Reg}_{load}$	– –	0.01 0.06	– –	%
Dropout Voltage (Measured at $V_{out} - 2\%$ ) ( $I_{out} = 300 \text{ mA}$ ) ( $I_{out} = 3.0 \text{ A}$ )	$V_{in} - V_{out}$	– –	0.75 1.0	1.0 1.25	V
Ground Pin Current in Normal Mode ( $I_{out} = 300 \text{ mA}$ ) ( $I_{out} = 3.0 \text{ A}$ )	$I_{Gnd}$	– –	0.4 1.0	1.0 2.0	mA
Ground Pin Current in Shutdown Mode ( $V_{shutdown} < 0.8$ )	$I_{Gnd}$	–	40	75	$\mu\text{A}$
Peak Output Limit	$I_{out}$	3.0	–	–	A
Internal Current Limitation		–	5.2	–	A
Thermal Shutdown		–	155	–	$^\circ\text{C}$
Shutdown Input Threshold Voltage (Voltage Increasing, Output Turns On, Logic High) (Voltage Decreasing, Output Turns Off, Logic Low)	$V_{th(shutdown)}$	2.0 –	– –	– 0.8	V
Shutdown Input Low Current ( $V_{in} = 0.8 \text{ V}$ ), (Negative Current Flows out of Pin)	$I_{IL}$	–10	–2.0	–	$\mu\text{A}$
Shutdown Input High Current ( $V_{in} = 2.0 \text{ V}$ ), (Negative Current Flows out of Pin)	$I_{IH}$	–10	–2.0	–	$\mu\text{A}$
Ripple Rejection ( $C_{out} = 100 \mu\text{F}$ , $f = 1.0 \text{ kHz}$ )	RR	–	76	–	dB
Soft-Start Pin Current	$I_{SS}$	–	11	–	$\mu\text{A}$

3. Low duty cycle pulse techniques are used during testing to maintain the junction temperature as close to ambient as possible.
4. Line regulation is defined as the change in output voltage for a change in input voltage. Load regulation is defined as the change in output voltage for a change in output load current at a constant temperature. The limits for line and load regulation are contained within the reference voltage specification,  $V_{adj}$ . Typical numbers are included in the specification for line and load regulation.

# NCP631

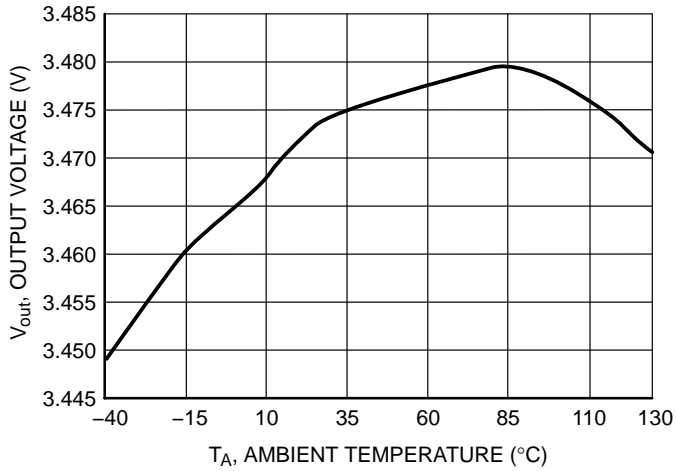

Figure 3. Output Voltage vs. Temperature

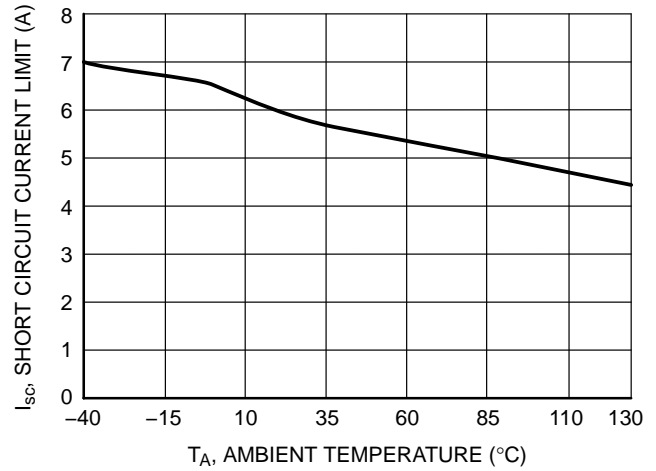

Figure 4. Short Circuit Limit vs. Temperature

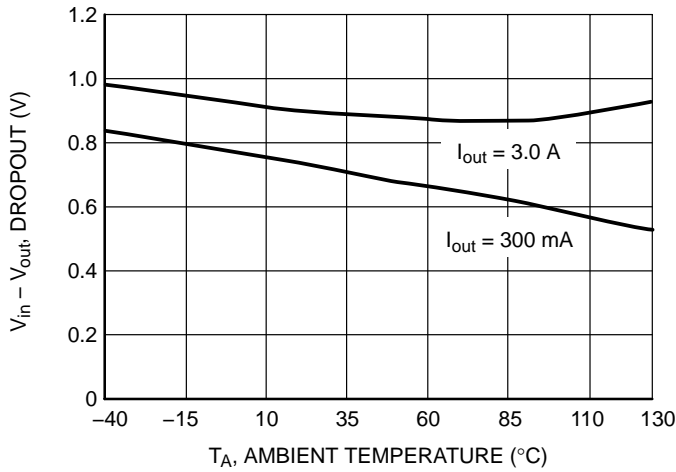

Figure 5. Dropout Voltage vs. Temperature

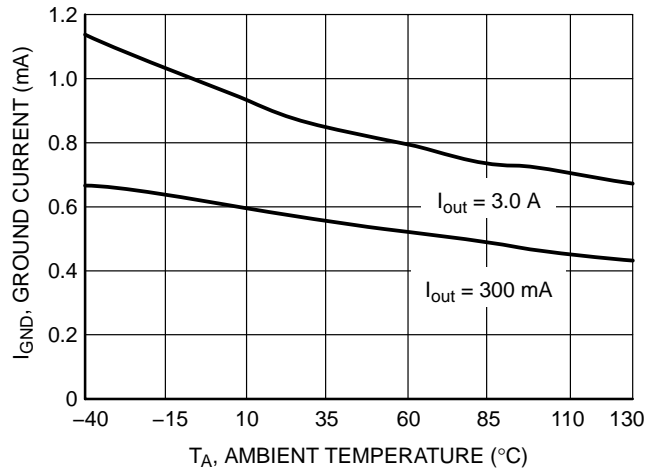

Figure 6. Ground Current vs. Temperature

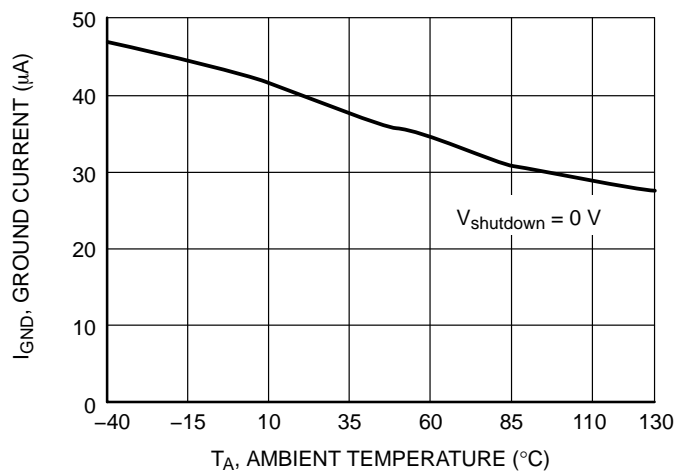

Figure 7. Ground Pin Current in Shutdown Mode vs. Temperature

# NCP631

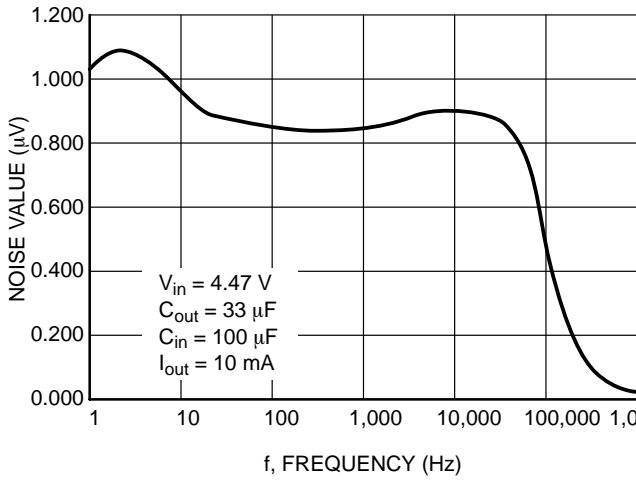

Figure 8. Noise Characterization

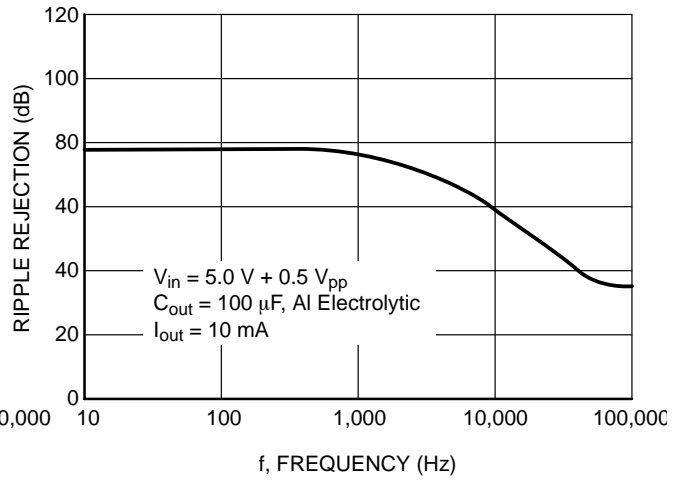

Figure 9. Ripple Rejection vs. Frequency

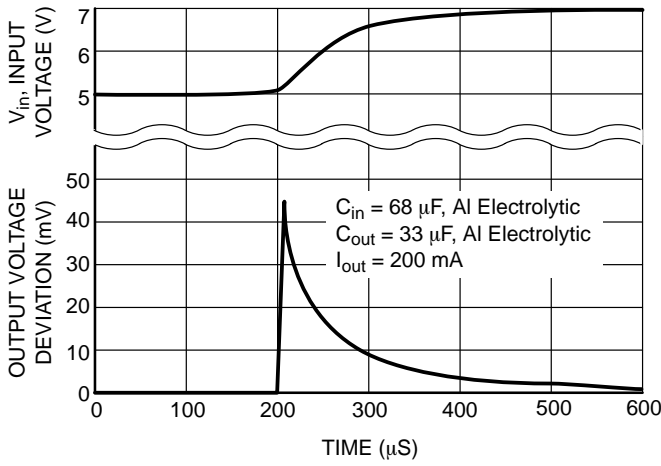

Figure 10. Line Transient

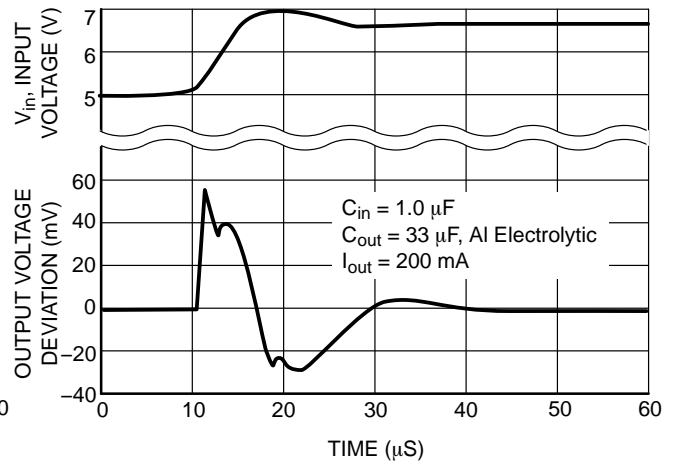

Figure 11. Line Transient

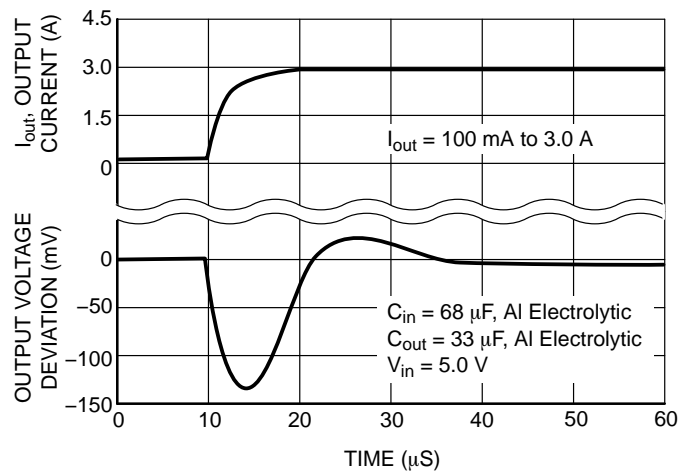

Figure 12. Load Transient

APPLICATIONS INFORMATION

**Input Capacitor**

The minimum capacitance required for stability is a 68  $\mu\text{F}$  aluminum electrolytic or tantalum capacitor. The maximum ESR allowed for stability is 5.0  $\Omega$ . The capacitor should be placed as close as possible to the input of the device.

The placement of a ceramic capacitor in parallel is not recommended due to possible instabilities.

**Output Capacitor**

A minimum output capacitor value of 33  $\mu\text{F}$  is required for stability. The type of capacitor can be aluminum electrolytic or tantalum capacitor. ESR can vary up to a maximum of 2.0  $\Omega$  for stability. The capacitor should be placed as close as possible to the output of the device.

The placement of a ceramic capacitor in parallel is not recommended due to possible instabilities.

**Soft-Start Function**

Slope of the output voltage during startup (Shutdown pin goes from low to high) can be adjusted by value of  $C_s$  capacitor. The basic formula for this function is:

$$\frac{dV}{dt} = \frac{I_{SS}}{C_s} = \frac{I_{out}}{C_{out}} * \frac{V_{ref}}{V_{out}} \quad (\text{eq. 1})$$

Where:

$$\begin{aligned} I_{SS} &= 11 \mu\text{A} \\ C_s &= 10 \text{ nF (typ)} \\ V_{ref} &= 1.2 \text{ V} \\ V_{out} &= 3.47 \text{ V} \end{aligned} \quad (\text{eq. 2})$$

Output current limitation during start-up:

$$I_{out} = \left( \frac{V_{out}}{V_{ref}} \right) * C_{out} * \frac{I_{SS}}{C_s} \quad (\text{eq. 3})$$

An example for  $C_{out} = 500 \mu\text{F}$ ,  $C_s = 10 \text{ nF}$ :

$$I_{out} = \left( \frac{3.47}{1.2} \right) * 500\text{E} - 6 * \frac{11\text{E} - 6}{10\text{E} - 9} = 1.59 \text{ A} \quad (\text{eq. 4})$$

Time when the output voltage will reach target value can be determined by:

$$T_s = V_{ref} * \frac{C_s}{I_{SS}} \quad (\text{eq. 5})$$

An example for  $C_s = 10 \text{ nF}$ :

$$T_s = 1.2 * \frac{10\text{E} - 9}{11\text{E} - 6} = 1.09 \text{ ms} \quad (\text{eq. 6})$$

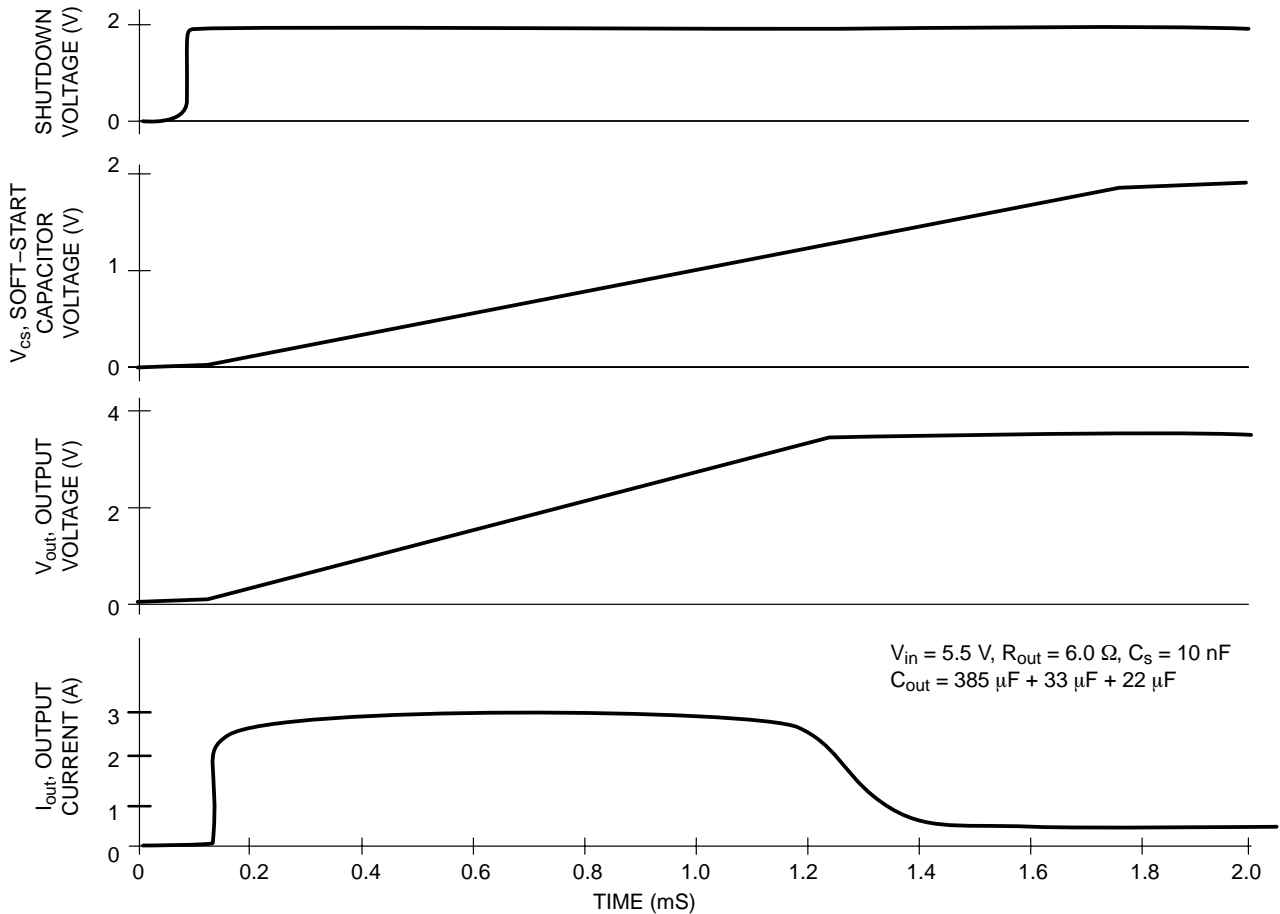

Figure 13. Typical Soft-Start Condition

# NCP631

## Reverse Current

Some situations might occur where the output pin is raised to a voltage while the input pin is at zero volts. This situation will not damage the device.

If the output voltage is raised to a higher voltage than the input voltage a diode is recommended from output to input with the anode connect to the output pin.

## Thermal Considerations

This series contains an internal thermal limiting circuit that is designed to protect the regulator in the event that the maximum junction temperature is exceeded. When activated, typically at 155°C, the regulator output switches off and then back on as the die cools. As a result, if the device is continuously operated in an overheated condition, the output will appear to be oscillating. This feature provides protection from a catastrophic device failure due to accidental overheating. It is not intended to be used as a

substitute for proper heatsinking. The maximum device power dissipation can be calculated by:

$$P_D = \frac{T_{J(max)} - T_A}{R_{\theta JA}} \quad (\text{eq. 7})$$

The devices are available in surface mount D<sup>2</sup>PAK package. The package has an exposed metal tab that is specifically designed to reduce the junction to air thermal resistance, R<sub>θJA</sub>, by utilizing the printed circuit board copper as a heat dissipater. Figure 13 shows typical R<sub>θJA</sub> values that can be obtained from a square pattern using economical single sided 2.0 ounce copper board material. The final product thermal limits should be tested and quantified in order to insure acceptable performance and reliability. The actual R<sub>θJA</sub> can vary considerably from the graphs shown. This will be due to any changes made in the copper aspect ratio of the final layout, adjacent heat sources, and air flow.

## TAPE AND REEL SPECIFICATION

SOP Description	Leads	Package Length	Package Width	Package Thickness	Reel Quantity	Tape Pitch	Tape Width	Vendor P/N
D <sup>2</sup> PAK	5	9.2 mm	10 mm	4.4 mm	800	16 mm	24 mm	DDPAK-B

# NCP631

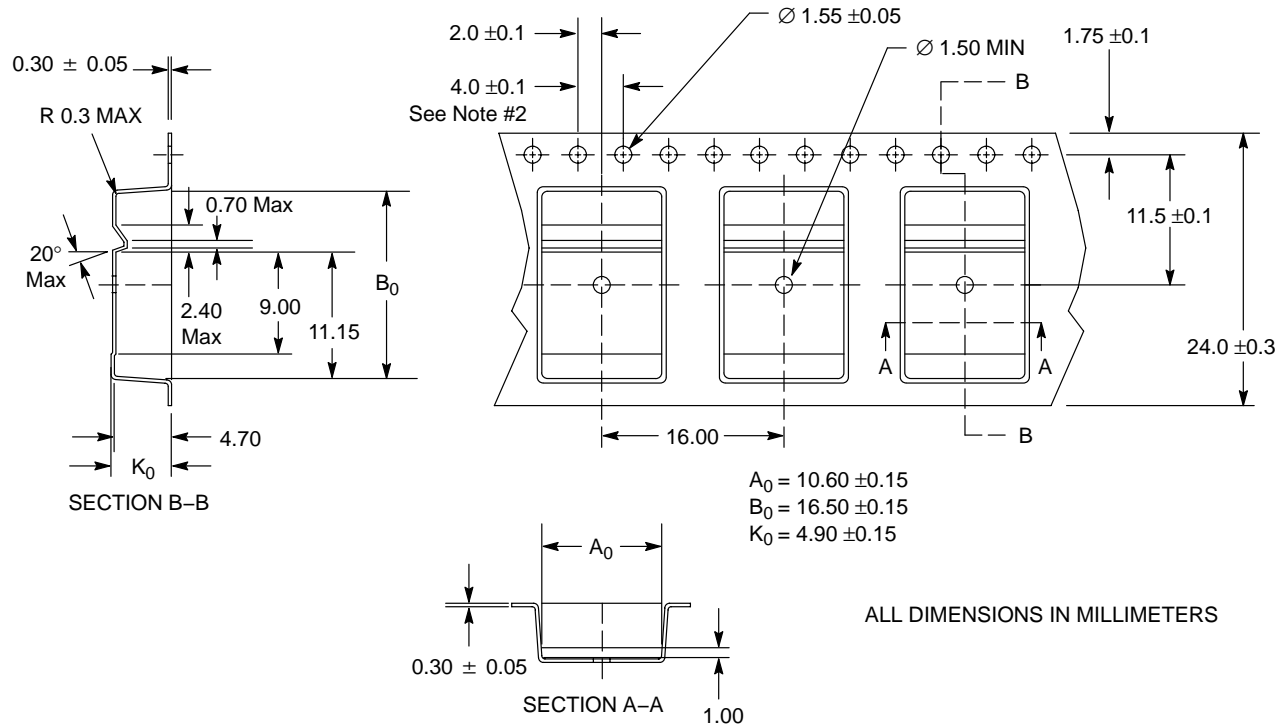

**NOTES:**

1.  $A_0$  &  $B_0$  MEASURED AT 0.3 mm ABOVE BASE OF POCKET
2. 10 PITCHES CUMULATIVE TOTAL  $\pm 0.2$  mm

**Figure 14. Package Carrier Dimensions**

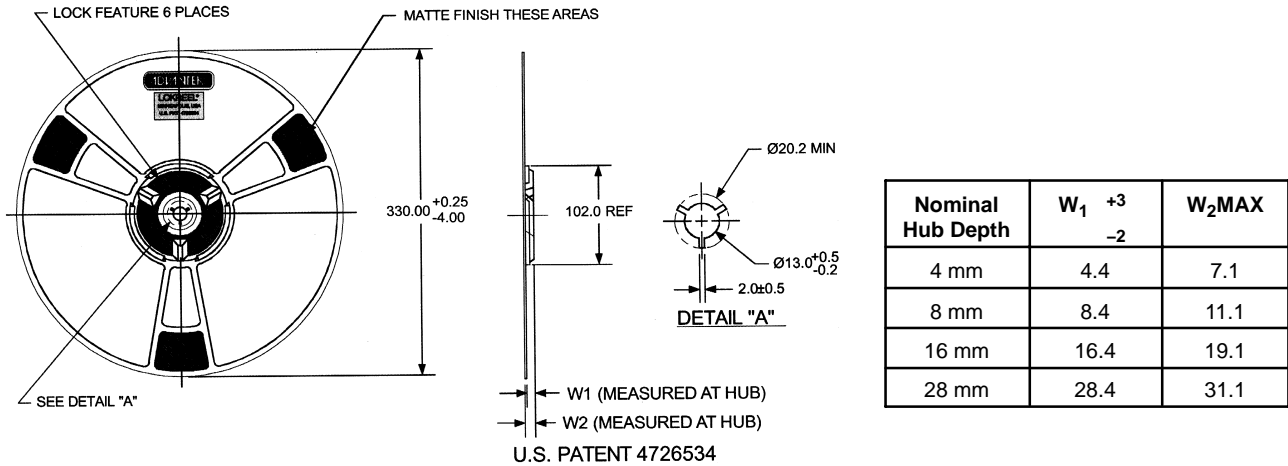
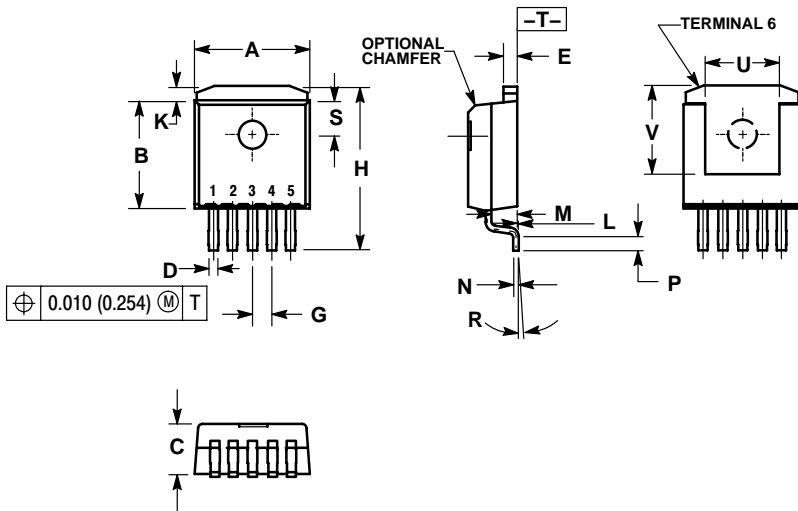

**Figure 15. Reel Dimensions**

# NCP631

## PACKAGE DIMENSIONS

### D<sup>2</sup>PAK 5 CASE 936A-02 ISSUE C



#### NOTES:

1. DIMENSIONING AND TOLERANCING PER ANSI Y14.5M, 1982.
2. CONTROLLING DIMENSION: INCH.
3. TAB CONTOUR OPTIONAL WITHIN DIMENSIONS A AND K.
4. DIMENSIONS U AND V ESTABLISH A MINIMUM MOUNTING SURFACE FOR TERMINAL 6.
5. DIMENSIONS A AND B DO NOT INCLUDE MOLD FLASH OR GATE PROTRUSIONS. MOLD FLASH AND GATE PROTRUSIONS NOT TO EXCEED 0.025 (0.635) MAXIMUM.

DIM	INCHES		MILLIMETERS	
	MIN	MAX	MIN	MAX
A	0.386	0.403	9.804	10.236
B	0.356	0.368	9.042	9.347
C	0.170	0.180	4.318	4.572
D	0.026	0.036	0.660	0.914
E	0.045	0.055	1.143	1.397
G	0.067 BSC		1.702 BSC	
H	0.539	0.579	13.691	14.707
K	0.050 REF		1.270 REF	
L	0.000	0.010	0.000	0.254
M	0.088	0.102	2.235	2.591
N	0.018	0.026	0.457	0.660
P	0.058	0.078	1.473	1.981
R	5° REF		5° REF	
S	0.116 REF		2.946 REF	
U	0.200 MIN		5.080 MIN	
V	0.250 MIN		6.350 MIN	

#### SOLDERING FOOTPRINT\*

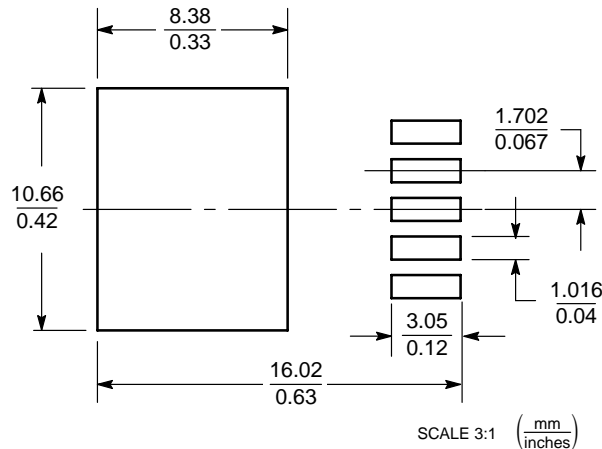

\*For additional information on our Pb-Free strategy and soldering details, please download the ON Semiconductor Soldering and Mounting Techniques Reference Manual, SOLDERRM/D.

ON Semiconductor and are registered trademarks of Semiconductor Components Industries, LLC (SCILLC). SCILLC reserves the right to make changes without further notice to any products herein. SCILLC makes no warranty, representation or guarantee regarding the suitability of its products for any particular purpose, nor does SCILLC assume any liability arising out of the application or use of any product or circuit, and specifically disclaims any and all liability, including without limitation special, consequential or incidental damages. "Typical" parameters which may be provided in SCILLC data sheets and/or specifications can and do vary in different applications and actual performance may vary over time. All operating parameters, including "Typicals" must be validated for each customer application by customer's technical experts. SCILLC does not convey any license under its patent rights nor the rights of others. SCILLC products are not designed, intended, or authorized for use as components in systems intended for surgical implant into the body, or other applications intended to support or sustain life, or for any other application in which the failure of the SCILLC product could create a situation where personal injury or death may occur. Should Buyer purchase or use SCILLC products for any such unintended or unauthorized application, Buyer shall indemnify and hold SCILLC and its officers, employees, subsidiaries, affiliates, and distributors harmless against all claims, costs, damages, and expenses, and reasonable attorney fees arising out of, directly or indirectly, any claim of personal injury or death associated with such unintended or unauthorized use, even if such claim alleges that SCILLC was negligent regarding the design or manufacture of the part. SCILLC is an Equal Opportunity/Affirmative Action Employer. This literature is subject to all applicable copyright laws and is not for resale in any manner.

#### PUBLICATION ORDERING INFORMATION

**LITERATURE FULFILLMENT:**  
Literature Distribution Center for ON Semiconductor  
P.O. Box 61312, Phoenix, Arizona 85082-1312 USA  
**Phone:** 480-829-7710 or 800-344-3860 Toll Free USA/Canada  
**Fax:** 480-829-7709 or 800-344-3867 Toll Free USA/Canada  
**Email:** orderlit@onsemi.com

**N. American Technical Support:** 800-282-9855 Toll Free  
USA/Canada

**Japan:** ON Semiconductor, Japan Customer Focus Center  
2-9-1 Kamimeguro, Meguro-ku, Tokyo, Japan 153-0051  
**Phone:** 81-3-5773-3850



**ON Semiconductor Website:** <http://onsemi.com>

**Order Literature:** <http://www.onsemi.com/litorder>

For additional information, please contact your local Sales Representative.

## Looking for pricing, stock, or lifecycle information?

Click below to explore more details on WIN SOURCE:

-  [View NCP631GD2TR4 on WIN SOURCE](#)
-  [ON Semiconductor](#) Information

## Optimize Your Supply Chain with WIN SOURCE Solutions

-  Global Sourcing Solution
-  Obsolete Management
-  Cost Control Management
-  Shortage Management
-  Alternative Solution
-  Excess Inventory Management