



THE DATASHEET OF NCP706MX21TAG



NCP706

1 A, 1% Precision Very Low Dropout Voltage Regulator with Enable

The NCP706 is a Very Low Dropout Regulator which provides up to 1 A of load current and maintains excellent output voltage accuracy of 1% including line, load and temperature variations. The operating input voltage range from 2.4 V up to 5.5 V makes this device suitable for Li-ion battery powered products as well as post-regulation applications. The product is available in 2.1 V, 2.2 V, 2.95 V, 3.0 V and 3.3 V fixed output voltage options. NCP706 is fully protected against overheating and output short circuit.

Very small 8-pin XDFN8 1.6 x 1.2, 04P package makes the device especially suitable for space constrained portable applications such as tablets and smartphones.

Features

- Operating Input Voltage Range: 2.4 V to 5.5 V
- Fixed Output Voltage Options: 2.1 V, 2.2 V, 2.95 V, 3.0 V and 3.3 V
Other Output Voltage Options Available on Request.
- Low Quiescent Current of Typ. 200 μ A
- Very Low Dropout: 155 mV Max. at $I_{OUT} = 1$ A
- $\pm 1\%$ Accuracy Over Load/Line/Temperature
- High PSRR: 60 dB at 1 kHz
- Internal Soft-Start to Limit the Inrush Current
- Thermal Shutdown and Current Limit Protections
- Stable with a 4.7 μ F Ceramic Output Capacitor
- Available in XDFN8 1.6 x 1.2, 04P 8-pin Package
- These are Pb-Free Devices

Typical Applications

- Tablets, Smartphones,
- Wireless Handsets, Portable Media Players
- Portable Medical Equipment
- Other Battery Powered Applications

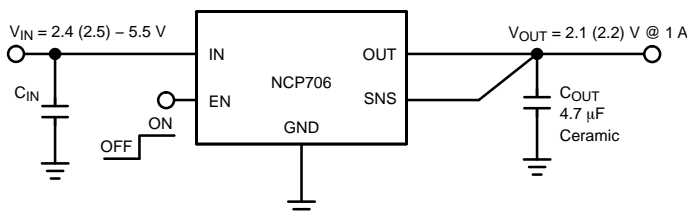

Figure 1. Typical Application Schematic



ON Semiconductor®

www.onsemi.com



XDFN8
CASE 711AS

MARKING DIAGRAM

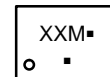

XX = Specific Device Code
M = Date Code
▪ = Pb-Free Package

(Note: Microdot may be in either location)

PIN CONNECTION

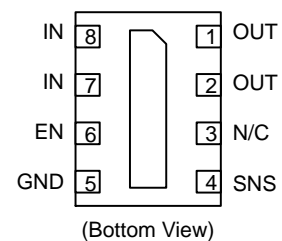
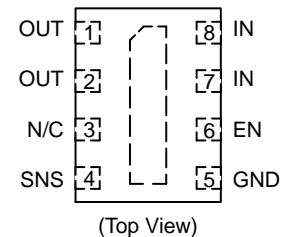

ORDERING INFORMATION

See detailed ordering, marking and shipping information on page 15 of this data sheet.

NCP706

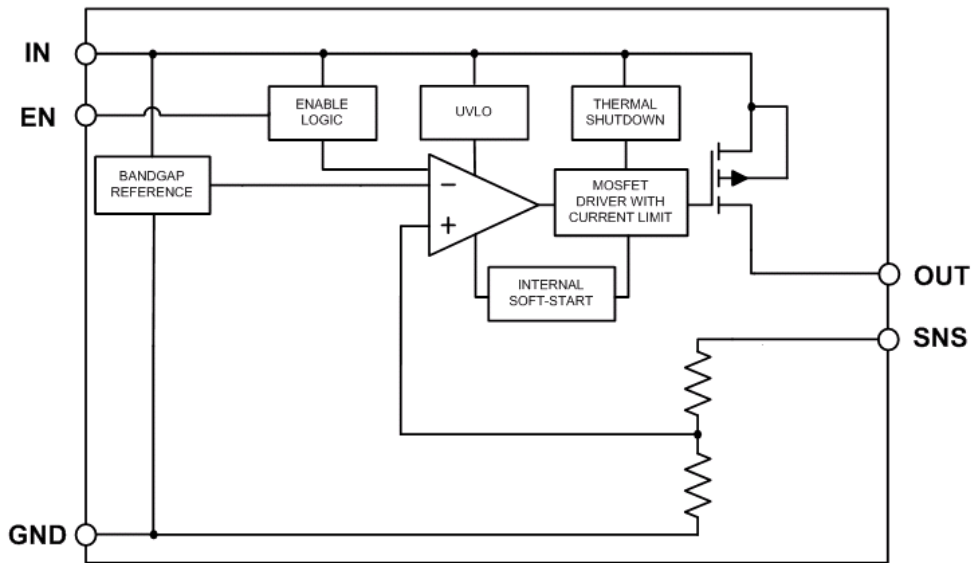

Figure 2. Simplified Internal Schematic Block Diagram

PIN FUNCTION DESCRIPTION

| Pin No. XDFN8 | Pin Name | Description |
|------------------|-------------|--|
| 1 | OUT | Regulated output voltage. A minimum 4.7 μ F ceramic capacitor is needed from this pin to ground to assure stability. |
| 2 | OUT | |
| 3 | N/C | Not connected. This pin can be tied to ground to improve thermal dissipation. |
| 4 | SNS | Remote sense connection. This pin should be connected to the output voltage rail. |
| 5 | GND | Power supply ground. |
| 6 | EN | Enable pin. Driving EN over 0.9 V turns on the regulator. Driving EN below 0.4 V puts the regulator into shutdown mode. |
| 7 | IN | Input pin. A small capacitor is needed from this pin to ground to assure stability. |
| 8 | IN | |
| - | Exposed Pad | This pad enhances thermal performance and is electrically connected to GND. It is recommended that the exposed pad is connected to the ground plane on the board or otherwise left open. |

NCP706

ABSOLUTE MAXIMUM RATINGS

| Rating | Symbol | Value | Unit |
|---|--------------|----------------------------|------|
| Input Voltage (Note 1) | V_{IN} | -0.3 V to 6 V | V |
| Output Voltage | V_{OUT} | -0.3 V to $V_{IN} + 0.3$ V | V |
| Enable Input | V_{EN} | -0.3 V to $V_{IN} + 0.3$ V | V |
| Output Short Circuit Duration | t_{SC} | Indefinite | s |
| Maximum Junction Temperature | $T_{J(MAX)}$ | 150 | °C |
| Storage Temperature | T_{STG} | -55 to 150 | °C |
| ESD Capability, Human Body Model (Note 2) | ESD_{HBM} | 2000 | V |
| ESD Capability, Machine Model (Note 2) | ESD_{MM} | 200 | V |

Stresses exceeding those listed in the Maximum Ratings table may damage the device. If any of these limits are exceeded, device functionality should not be assumed, damage may occur and reliability may be affected.

1. Refer to ELECTRICAL CHARACTERISTICS and APPLICATION INFORMATION for Safe Operating Area.
2. This device series incorporates ESD protection and is tested by the following methods:
ESD Human Body Model tested per EIA/JESD22-A114
Latch-up Current Maximum Rating tested per JEDEC standard: JESD78

THERMAL CHARACTERISTICS

| Rating | Symbol | Value | Unit |
|--|-----------------|-------|------|
| Thermal Characteristics, XDFN8 1.6x1.2, 04P Thermal Resistance, Junction-to-Air | $R_{\theta JA}$ | 160 | °C/W |

NCP706

ELECTRICAL CHARACTERISTICS – VOLTAGE VERSION 2.1 V

–40°C ≤ T_J ≤ 125°C; V_{IN} = V_{OUT(NOM)} + 0.3 V or 2.4 V, whichever is greater; I_{OUT} = 10 mA, C_{IN} = C_{OUT} = 4.7 μF, V_{EN} = 0.9 V, unless otherwise noted. Typical values are at T_J = +25°C. (Note 3)

| Parameter | Test Conditions | Symbol | Min | Typ | Max | Unit |
|-------------------------------------|--|----------------------|---------------------------------------|----------------|-------|-------------------|
| Operating Input Voltage | | V _{IN} | 2.4 | | 5.5 | V |
| Undervoltage lock-out | V _{IN} rising | UVLO | 1.2 | 1.6 | 1.9 | V |
| Output Voltage Accuracy | V _{OUT} + 0.3 V ≤ V _{IN} ≤ 4.5 V, I _{OUT} = 0 – 1 A | V _{OUT} | 2.079 | 2.10 | 2.121 | V |
| Line Regulation | V _{OUT} + 0.3 V ≤ V _{IN} ≤ 4.5 V, I _{OUT} = 10 mA | Reg _{LINE} | | 2 | | mV |
| Load Regulation | I _{OUT} = 0 mA to 1 A | Reg _{LOAD} | | 2 | | mV |
| Load Transient | I _{OUT} = 10 mA to 1 A or 10 mA to 1 A in 10 μs, C _{OUT} = 10 μF | Tran _{LOAD} | | ±120 | | mV |
| Dropout voltage (Note 4) | I _{OUT} = 1 A, V _{OUT(nom)} = 2.1 V | V _{DO} | | | 300 | mV |
| Output Current Limit | V _{OUT} = 90% V _{OUT(nom)} | I _{CL} | 1.1 | | | A |
| Quiescent current | I _{OUT} = 0 mA | I _Q | | 180 | 230 | μA |
| Ground current | I _{OUT} = 1 A | I _{GND} | | 200 | | μA |
| Shutdown current | V _{EN} ≤ 0 V, V _{IN} = 2.0 to 5.5 V | | | 0.1 | 1 | μA |
| Reverse Leakage Current in Shutdown | V _{IN} = 5.5 V, V _{OUT} = V _{OUT(NOM)} , V _{EN} < 0.4 V | I _{REV} | | 1.5 | 5 | μA |
| EN Pin High Threshold | V _{EN} Voltage increasing | V _{EN_HI} | 0.9 | | | V |
| EN Pin Low Threshold | V _{EN} Voltage decreasing | V _{EN_LO} | | | 0.4 | V |
| EN Pin Input Current | V _{EN} = 5.5 V | I _{EN} | | 100 | 500 | nA |
| Turn-on Time | C _{OUT} = 4.7 μF, from assertion EN pin to 98% V _{out(nom)} | t _{ON} | | 200 | | μs |
| Power Supply Rejection Ratio | V _{IN} = 2.6 V, V _{OUT} = 2.1 V I _{OUT} = 0.5 A | PSRR | f = 100 Hz f = 1 kHz f = 10 kHz | 60 60 40 | | dB |
| Output Noise Voltage | V _{OUT} = 2.1 V, V _{IN} = 2.6 V, I _{OUT} = 0.5 A f = 100 Hz to 100 kHz | V _{NOISE} | | 280 | | μV _{rms} |
| Thermal Shutdown Temperature | Temperature increasing from T _J = +25°C | T _{SD} | | 160 | | °C |
| Thermal Shutdown Hysteresis | Temperature falling from T _{SD} | T _{SDH} | – | 20 | – | °C |

3. Performance guaranteed over the indicated operating temperature range by design and/or characterization production tested at T_J = T_A = 25°C. Low duty cycle pulse techniques are used during testing to maintain the junction temperature as close to ambient as possible.
4. Characterized when V_{OUT} falls 100 mV below the regulated voltage at V_{IN} = V_{OUT(NOM)} + 0.3 V.

NCP706

ELECTRICAL CHARACTERISTICS – VOLTAGE VERSION 2.2 V

–40°C ≤ T_J ≤ 125°C; V_{IN} = V_{OUT(NOM)} + 0.3 V or 2.5 V, whichever is greater; I_{OUT} = 10 mA, C_{IN} = C_{OUT} = 4.7 μF, V_{EN} = 0.9 V, unless otherwise noted. Typical values are at T_J = +25°C. (Note 5)

| Parameter | Test Conditions | Symbol | Min | Typ | Max | Unit |
|---|--|--|-------|----------------|-------|-------------------|
| Operating Input Voltage | | V _{IN} | 2.5 | | 5.5 | V |
| Undervoltage lock-out | V _{IN} rising | UVLO | 1.2 | 1.6 | 1.9 | V |
| Output Voltage Accuracy | V _{OUT} + 0.3 V ≤ V _{IN} ≤ 4.5 V, I _{OUT} = 0 – 1 A | V _{OUT} | 2.178 | 2.2 | 2.222 | V |
| Line Regulation | V _{OUT} + 0.3 V ≤ V _{IN} ≤ 4.5 V, I _{OUT} = 10 mA | Reg _{LINE} | | 2 | | mV |
| Load Regulation | I _{OUT} = 0 mA to 1 A | Reg _{LOAD} | | 2 | | mV |
| Load Transient | I _{OUT} = 10 mA to 1 A or 10 mA to 1 A in 10 μs, C _{OUT} = 10 μF | Tran _{LOAD} | | ±120 | | mV |
| Dropout voltage (Note 6) | I _{OUT} = 1 A, V _{OUT(nom)} = 2.2 V | V _{DO} | | | 300 | mV |
| Output Current Limit | V _{OUT} = 90% V _{OUT(nom)} | I _{CL} | 1.1 | | | A |
| Quiescent current | I _{OUT} = 0 mA | I _Q | | 180 | 230 | μA |
| Ground current | I _{OUT} = 1 A | I _{IGND} | | 200 | | μA |
| Shutdown current | V _{EN} ≤ 0 V, V _{IN} = 2.0 to 5.5 V | | | 0.1 | 1 | μA |
| EN Pin High Threshold EN Pin Low Threshold | V _{EN} Voltage increasing V _{EN} Voltage decreasing | V _{EN_HI} V _{EN_LO} | 0.9 | | 0.4 | V |
| EN Pin Input Current | V _{EN} = 5.5 V | I _{EN} | | 100 | 500 | nA |
| Turn-on Time | C _{OUT} = 4.7 μF, from assertion EN pin to 98% V _{out(nom)} | t _{ON} | | 200 | | μs |
| Power Supply Rejection Ratio | V _{IN} = 3.2 V, V _{OUT} = 2.2 V I _{OUT} = 0.5 A | f = 100 Hz f = 1 kHz f = 10 kHz | PSRR | 55 70 60 | | dB |
| Output Noise Voltage | V _{OUT} = 2.2 V, V _{IN} = 2.7 V, I _{OUT} = 0.5 A f = 100 Hz to 100 kHz | V _{NOISE} | | 300 | | μV _{rms} |
| Thermal Shutdown Temperature | Temperature increasing from T _J = +25°C | T _{SD} | | 160 | | °C |
| Thermal Shutdown Hysteresis | Temperature falling from T _{SD} | T _{SDH} | – | 20 | – | °C |

5. Performance guaranteed over the indicated operating temperature range by design and/or characterization production tested at T_J = T_A = 25°C. Low duty cycle pulse techniques are used during testing to maintain the junction temperature as close to ambient as possible.
6. Characterized when V_{OUT} falls 100 mV below the regulated voltage at V_{IN} = V_{OUT(NOM)} + 0.3 V.

NCP706

ELECTRICAL CHARACTERISTICS – VOLTAGE VERSION 2.95 V

–40°C ≤ T_J ≤ 125°C; V_{IN} = V_{OUT(NOM)} + 0.3 V or 3.3 V, whichever is greater; I_{OUT} = 10 mA, C_{IN} = C_{OUT} = 4.7 μF, V_{EN} = 0.9 V, unless otherwise noted. Typical values are at T_J = +25°C. (Note 7)

| Parameter | Test Conditions | Symbol | Min | Typ | Max | Unit |
|---|--|--|--------|----------------|--------|-------------------|
| Operating Input Voltage | | V _{IN} | 2.4 | | 5.5 | V |
| Undervoltage lock-out | V _{IN} rising, I _{OUT} = 0 | UVLO | 1.2 | 1.6 | 1.9 | V |
| Output Voltage Accuracy | V _{OUT} + 0.3 V ≤ V _{IN} ≤ 4.5 V, I _{OUT} = 0 – 1 A | V _{OUT} | 2.9205 | 2.95 | 2.9795 | V |
| Line Regulation | V _{OUT} + 0.3 V ≤ V _{IN} ≤ 4.5 V, I _{OUT} = 10 mA | Reg _{LINE} | | 2 | | mV |
| Load Regulation | I _{OUT} = 0 mA to 1 A, V _{IN} = 3.3 V | Reg _{LOAD} | | 2 | | mV |
| Load Transient | I _{OUT} = 10 mA to 1 A in 10 μs, V _{IN} = 3.5 V C _{OUT} = 10 μF | Tran _{LOAD} | | ±120 | | mV |
| Dropout voltage (Note 8) | I _{OUT} = 1 A, V _{OUT(nom)} = 3.0 V | V _{DO} | | 155 | 230 | mV |
| Output Current Limit | V _{OUT} = 90% V _{OUT(nom)} | I _{CL} | 1.1 | | | A |
| Quiescent current | I _{OUT} = 0 mA | I _Q | | 170 | 230 | μA |
| Ground current | I _{OUT} = 1 A | I _{GND} | | 200 | | μA |
| Shutdown current | V _{EN} ≤ 0 V, V _{IN} = 2.4 to 5.5 V | | | 0.1 | 1 | μA |
| EN Pin High Threshold EN Pin Low Threshold | V _{EN} Voltage increasing V _{EN} Voltage decreasing | V _{EN_HI} V _{EN_LO} | 0.9 | | 0.4 | V |
| EN Pin Input Current | V _{EN} = 5.5 V | I _{EN} | | 100 | 500 | nA |
| Turn-on Time | C _{OUT} = 4.7 μF, from assertion EN pin to 98% V _{out(nom)} | t _{ON} | | 150 | | μs |
| Power Supply Rejection Ratio | V _{IN} = 3.5 V + 200 mVpp modulation, V _{OUT} = 2.95 V I _{OUT} = 0.5 A, C _{OUT} = 4.7 μF | PSRR | | 65 58 52 | | dB |
| Output Noise Voltage | V _{OUT} = 2.95 V, V _{IN} = 4.0 V, I _{OUT} = 0.5 A f = 100 Hz to 100 kHz | V _{NOISE} | | 300 | | μV _{rms} |
| Thermal Shutdown Temperature | Temperature increasing from T _J = +25°C | T _{SD} | | 160 | | °C |
| Thermal Shutdown Hysteresis | Temperature falling from T _{SD} | T _{SDH} | – | 20 | – | °C |

7. Performance guaranteed over the indicated operating temperature range by design and/or characterization production tested at T_J = T_A = 25°C. Low duty cycle pulse techniques are used during testing to maintain the junction temperature as close to ambient as possible.

8. Characterized when V_{OUT} falls 90 mV below the regulated voltage at V_{IN} = 3.3 V, I_{OUT} = 10 mA.

NCP706

ELECTRICAL CHARACTERISTICS – VOLTAGE VERSION 3.0 V

–40°C ≤ T_J ≤ 125°C; V_{IN} = V_{OUT(NOM)} + 0.3 V or 3.3 V, whichever is greater; I_{OUT} = 10 mA, C_{IN} = C_{OUT} = 4.7 μF, V_{EN} = 0.9 V, unless otherwise noted. Typical values are at T_J = +25°C. (Note 9)

| Parameter | Test Conditions | Symbol | Min | Typ | Max | Unit |
|---|--|--|------|----------------|------|-------------------|
| Operating Input Voltage | | V _{IN} | 2.4 | | 5.5 | V |
| Undervoltage lock-out | V _{IN} rising, I _{OUT} = 0 | UVLO | 1.2 | 1.6 | 1.9 | V |
| Output Voltage Accuracy | V _{OUT} + 0.3 V ≤ V _{IN} ≤ 4.5 V, I _{OUT} = 0 – 1 A | V _{OUT} | 2.97 | 3.0 | 3.03 | V |
| Line Regulation | V _{OUT} + 0.3 V ≤ V _{IN} ≤ 4.5 V, I _{OUT} = 10 mA | Reg _{LINE} | | 2 | | mV |
| Load Regulation | I _{OUT} = 0 mA to 1 A, V _{IN} = 3.3 V | Reg _{LOAD} | | 2 | | mV |
| Load Transient | I _{OUT} = 10 mA to 1 A in 10 μs, V _{IN} = 3.5 V C _{OUT} = 10 μF | Tran _{LOAD} | | ±120 | | mV |
| Dropout voltage (Note 10) | I _{OUT} = 1 A, V _{OUT(nom)} = 3.0 V | V _{DO} | | 155 | 230 | mV |
| Output Current Limit | V _{OUT} = 90% V _{OUT(nom)} | I _{CL} | 1.1 | | | A |
| Quiescent current | I _{OUT} = 0 mA | I _Q | | 170 | 230 | μA |
| Ground current | I _{OUT} = 1 A | I _{GND} | | 200 | | μA |
| Shutdown current | V _{EN} ≤ 0 V, V _{IN} = 2.0 to 5.5 V | | | 0.1 | 1 | μA |
| EN Pin High Threshold EN Pin Low Threshold | V _{EN} Voltage increasing V _{EN} Voltage decreasing | V _{EN_HI} V _{EN_LO} | 0.9 | | 0.4 | V |
| EN Pin Input Current | V _{EN} = 5.5 V | I _{EN} | | 100 | 500 | nA |
| Turn-on Time | C _{OUT} = 4.7 μF, from assertion EN pin to 98% V _{out(nom)} | t _{ON} | | 150 | | μs |
| Power Supply Rejection Ratio | V _{IN} = 3.5 V + 200 mVpp modulation, V _{OUT} = 3.0 V I _{OUT} = 0.5 A, C _{OUT} = 4.7 μF | PSRR | | 65 58 52 | | dB |
| Output Noise Voltage | V _{OUT} = 3.0 V, V _{IN} = 4.0 V, I _{OUT} = 0.5 A f = 100 Hz to 100 kHz | V _{NOISE} | | 300 | | μV _{rms} |
| Thermal Shutdown Temperature | Temperature increasing from T _J = +25°C | T _{SD} | | 160 | | °C |
| Thermal Shutdown Hysteresis | Temperature falling from T _{SD} | T _{SDH} | – | 20 | – | °C |

9. Performance guaranteed over the indicated operating temperature range by design and/or characterization production tested at T_J = T_A = 25°C. Low duty cycle pulse techniques are used during testing to maintain the junction temperature as close to ambient as possible.

10. Characterized when V_{OUT} falls 90 mV below the regulated voltage at V_{IN} = 3.3 V, I_{OUT} = 10 mA.

Product parametric performance is indicated in the Electrical Characteristics for the listed test conditions, unless otherwise noted. Product performance may not be indicated by the Electrical Characteristics if operated under different conditions.

TYPICAL CHARACTERISTICS

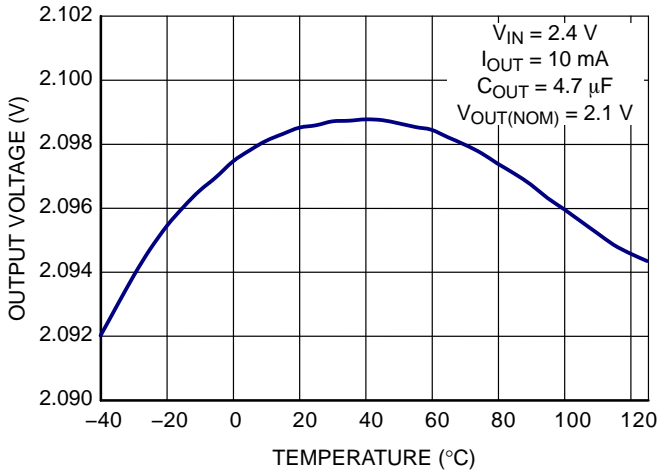

Figure 3. Output Voltage vs. Temperature

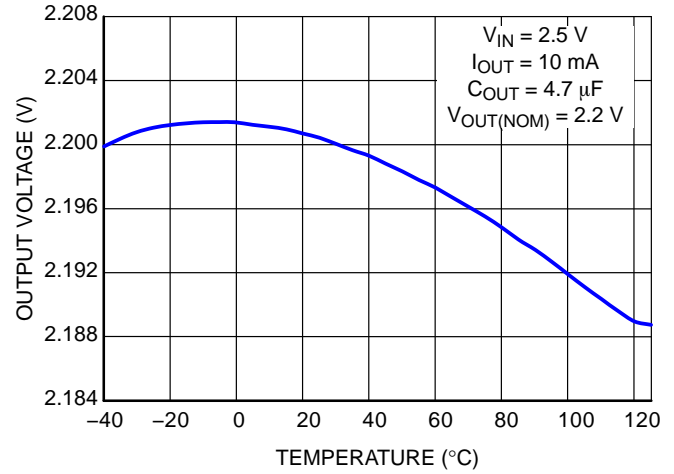

Figure 4. Output Voltage vs. Temperature

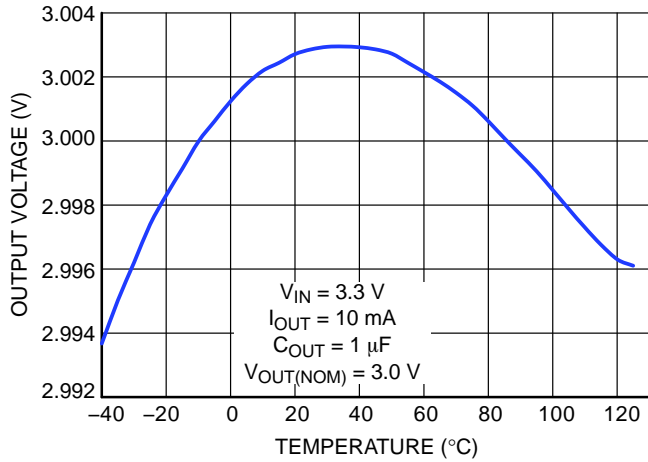

Figure 5. Output Voltage vs. Temperature

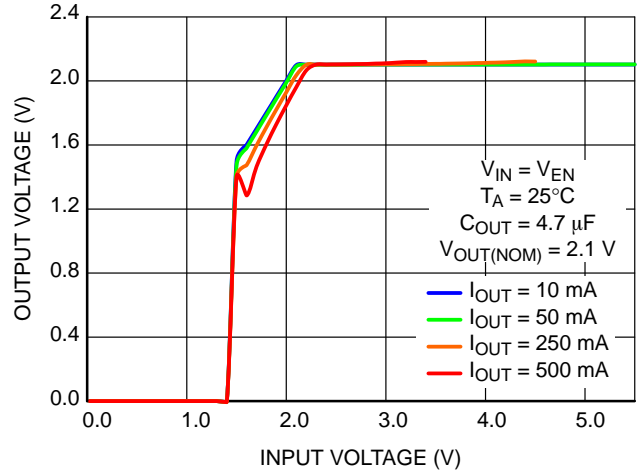

Figure 6. Output Voltage vs. Input Voltage

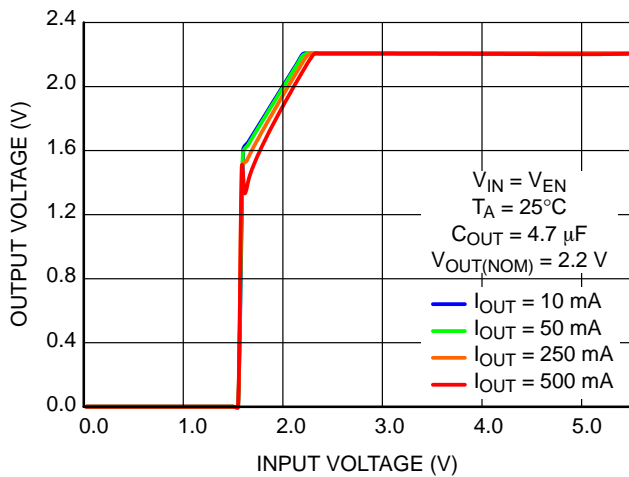

Figure 7. Output Voltage vs. Input Voltage

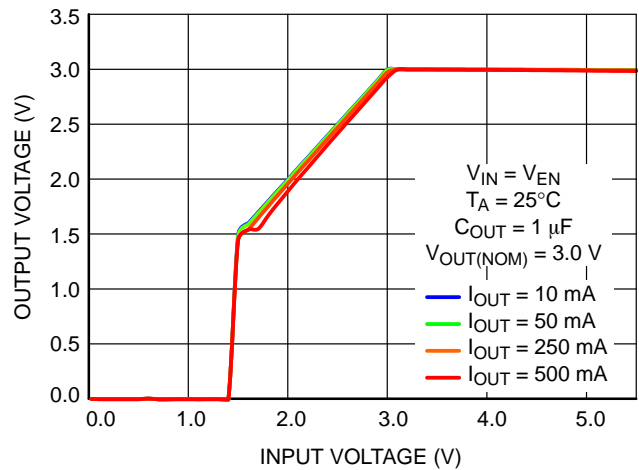

Figure 8. Output Voltage vs. Input Voltage

TYPICAL CHARACTERISTICS

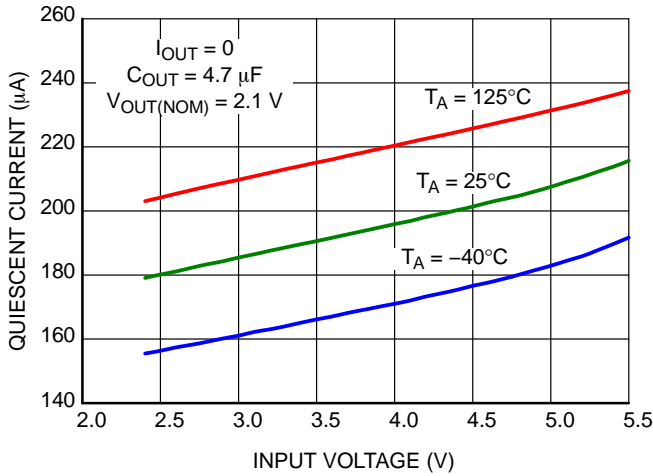

Figure 9. Quiescent Current vs. Input Voltage

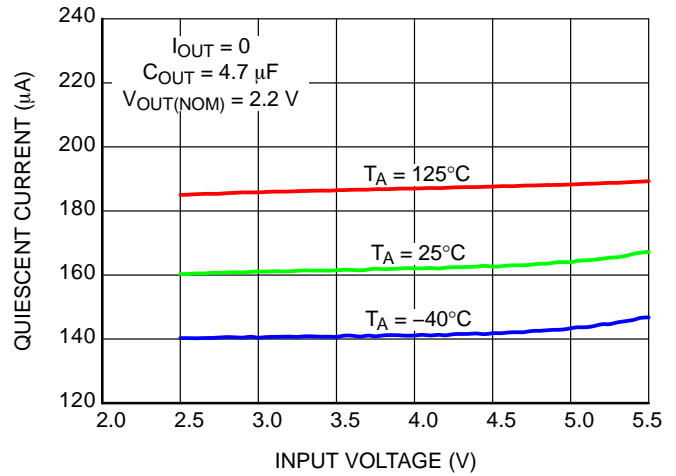

Figure 10. Quiescent Current vs. Input Voltage

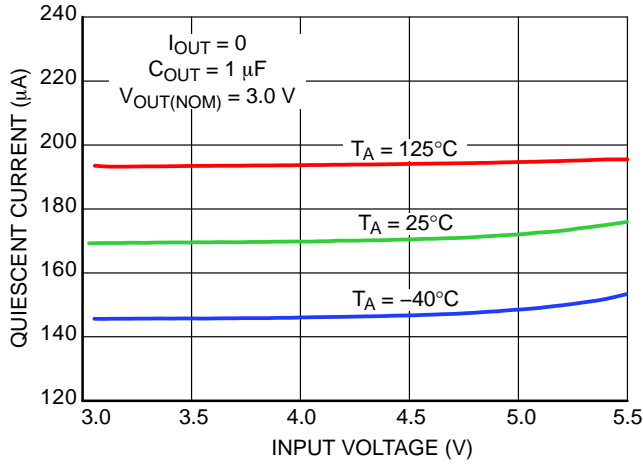

Figure 11. Quiescent Current vs. Input Voltage

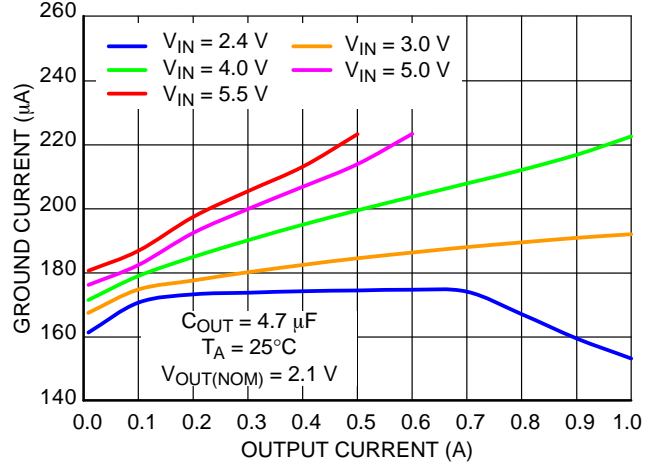

Figure 12. Ground Current vs. Output Current

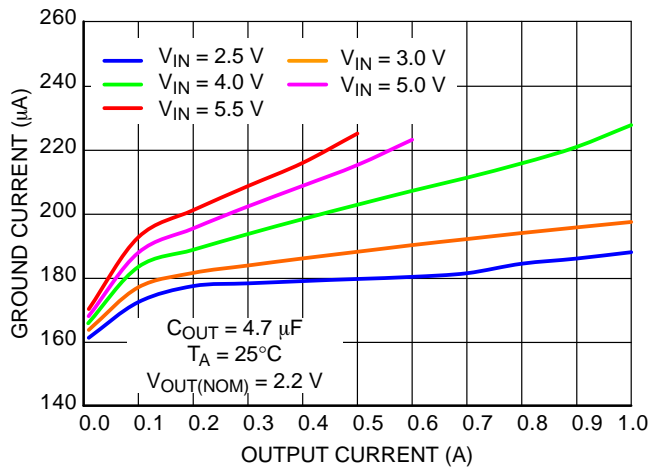

Figure 13. Ground Current vs. Output Current

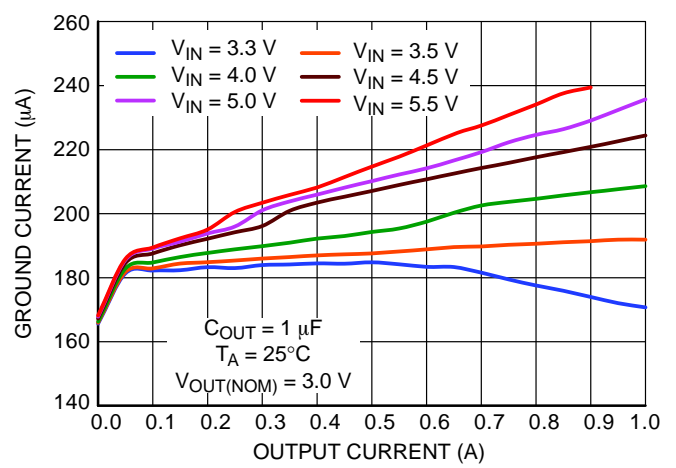

Figure 14. Ground Current vs. Output Current

TYPICAL CHARACTERISTICS

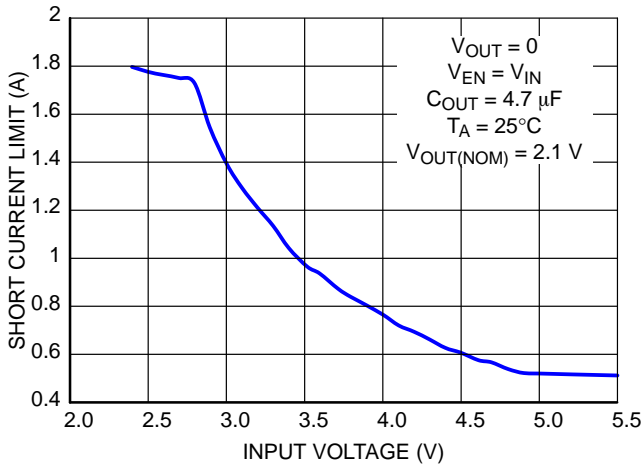

Figure 15. Short Current Limitation vs. Input Voltage

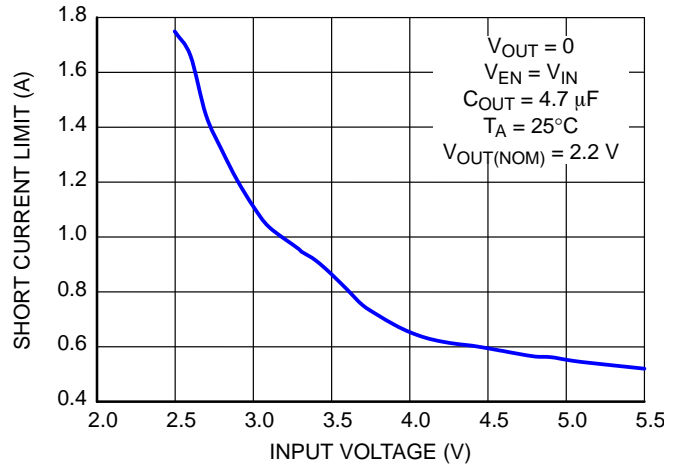

Figure 16. Short Current Limitation vs. Input Voltage

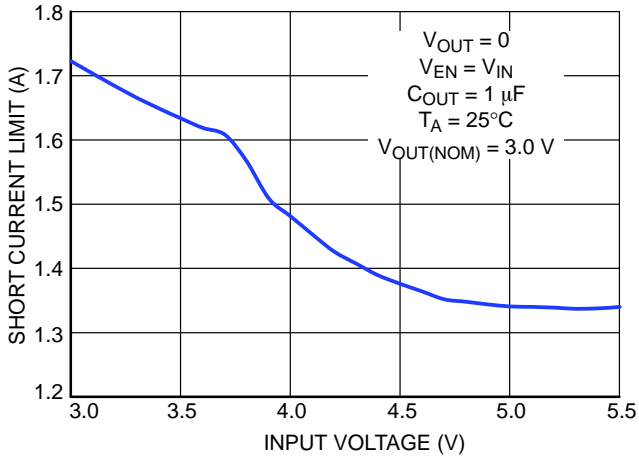

Figure 17. Short Current Limitation vs. Input Voltage

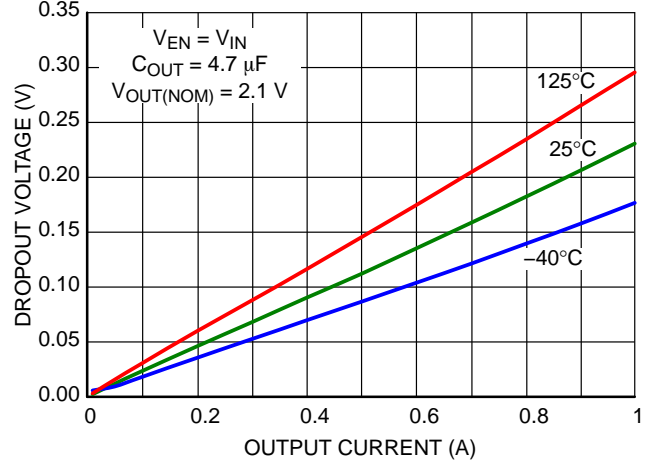

Figure 18. Dropout Voltage vs. Output Current

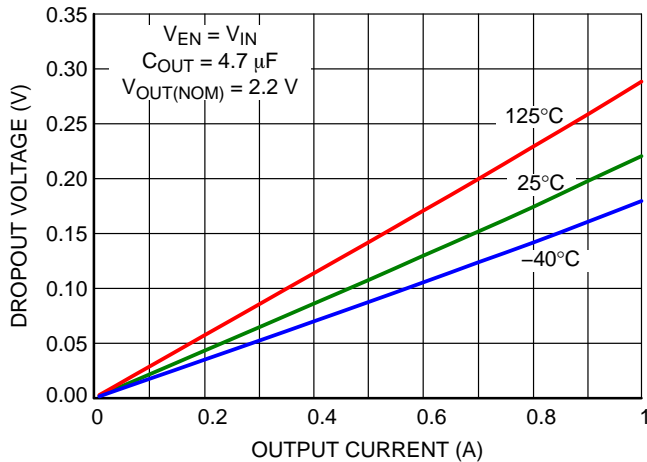

Figure 19. Dropout Voltage vs. Output Current

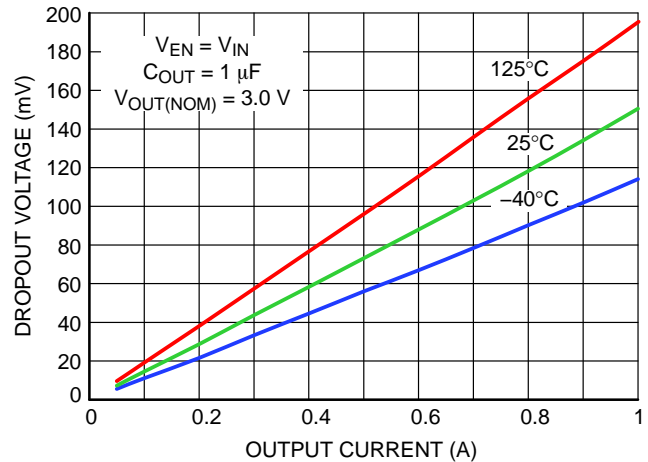

Figure 20. Dropout Voltage vs. Output Current

TYPICAL CHARACTERISTICS

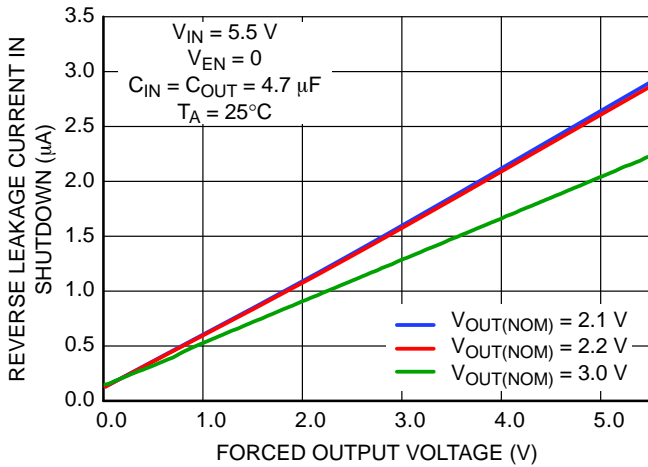

Figure 21. Reverse Leakage Current in Shutdown

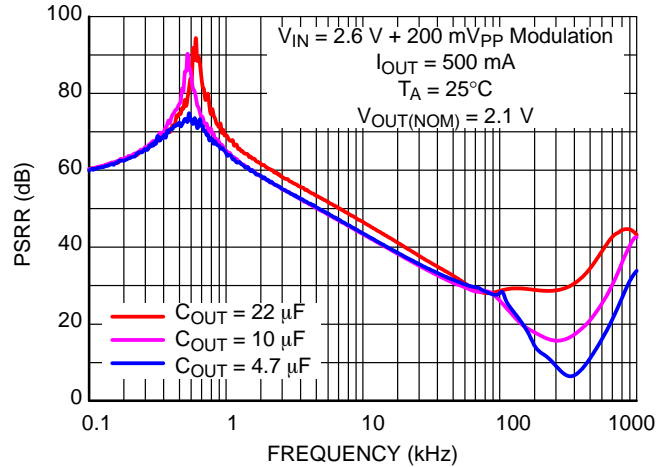

Figure 22. PSRR vs. Frequency & Output Capacitor

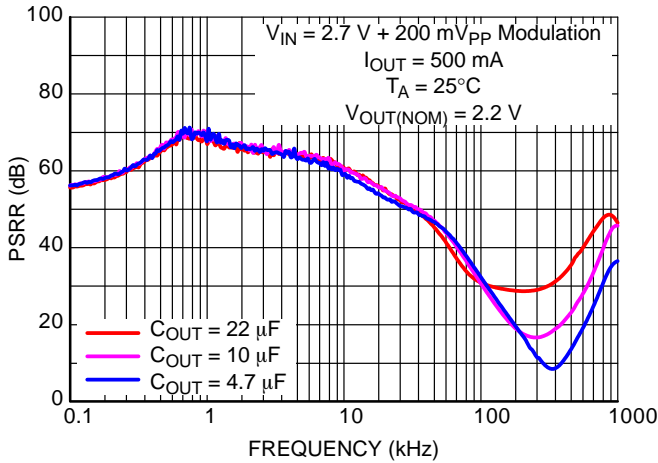

Figure 23. PSRR vs. Frequency & Output Capacitor

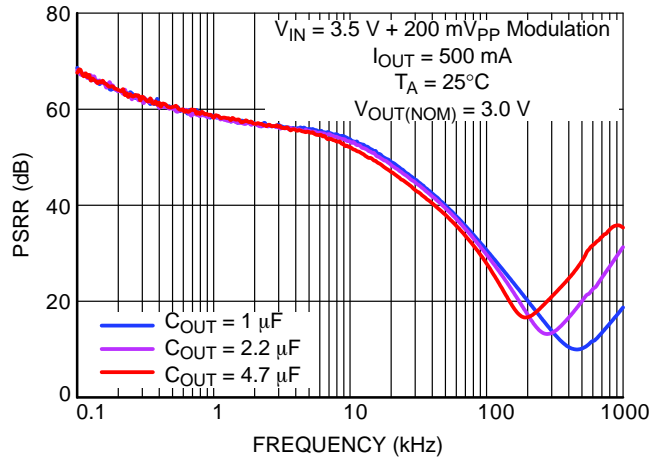

Figure 24. PSRR vs. Frequency & Output Capacitor

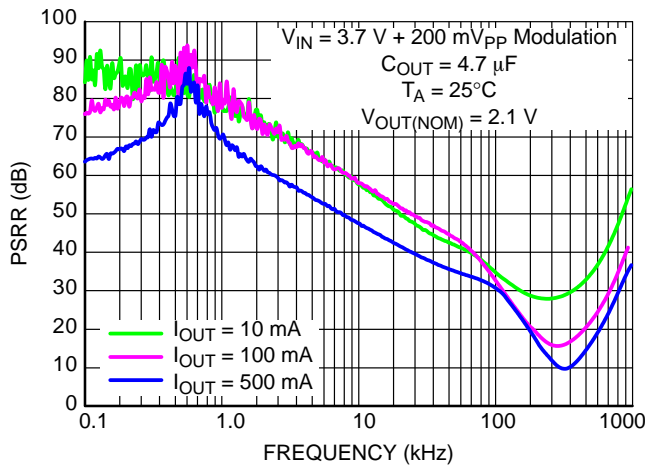

Figure 25. PSRR vs. Frequency & Output Current

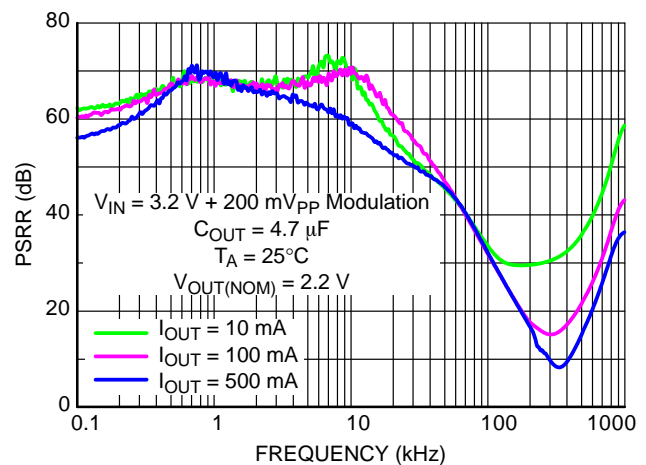

Figure 26. PSRR vs. Frequency & Output Current

TYPICAL CHARACTERISTICS

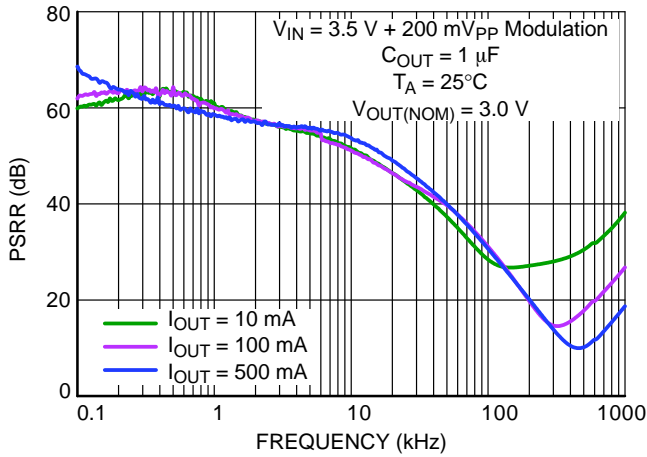

Figure 27. PSRR vs. Frequency & Output Current

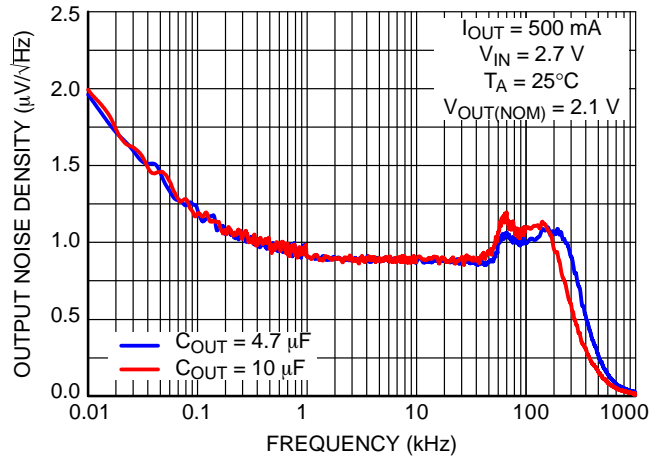

Figure 28. Output Noise Density vs. Frequency

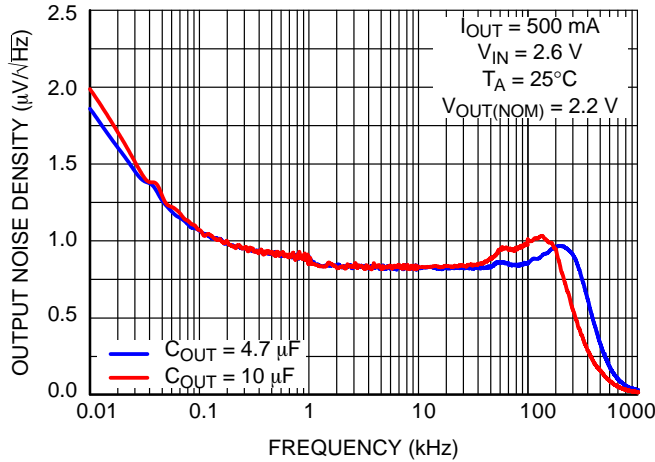

Figure 29. Output Noise Density vs. Frequency

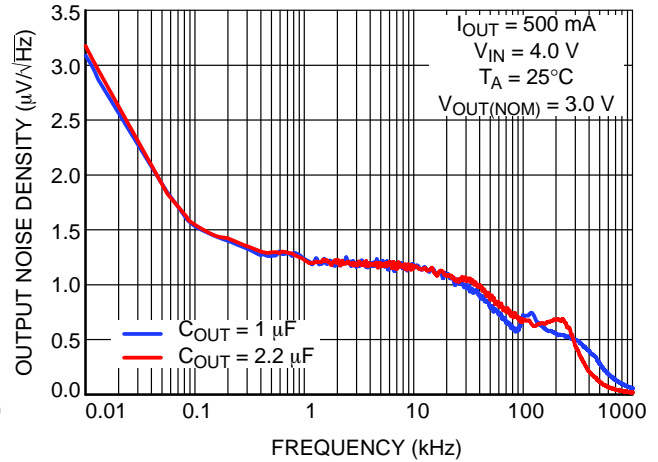

Figure 30. Output Noise Density vs. Frequency

TYPICAL CHARACTERISTICS

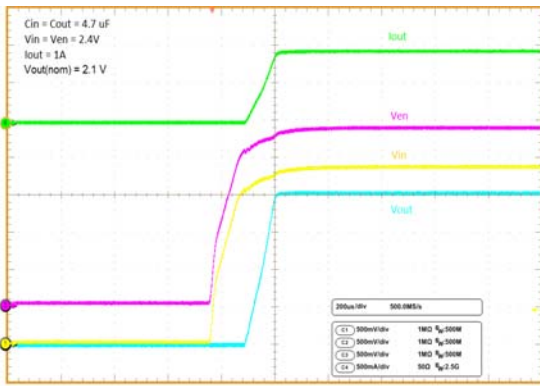

Figure 31. Turn-on by Coupled Input and Enable Pins

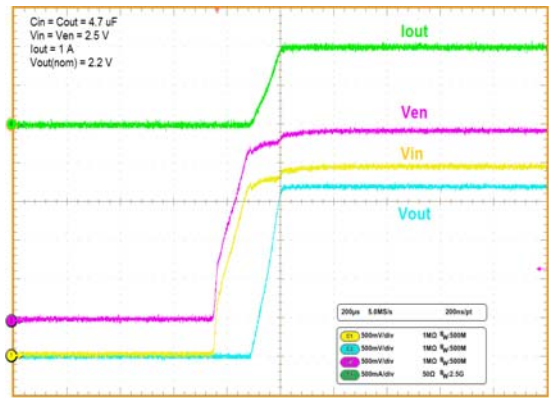

Figure 32. Turn-on by Coupled Input and Enable Pins

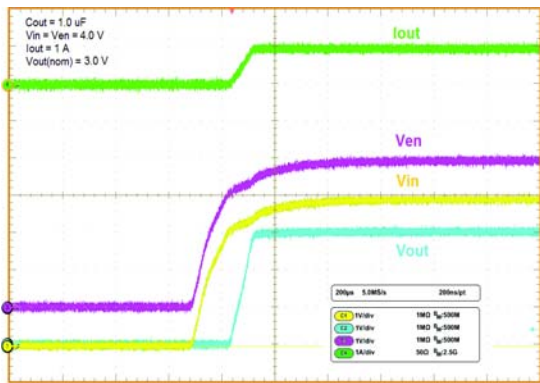

Figure 33. Turn-on by Coupled Input and Enable Pins

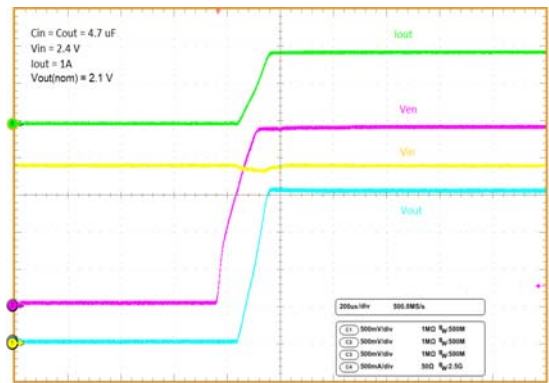

Figure 34. Turn-on by Enable Signal

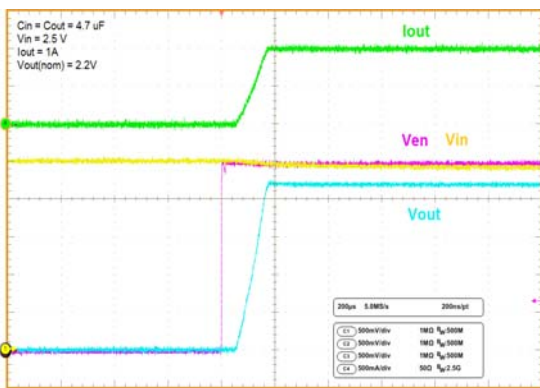

Figure 35. Turn-on by Enable Signal

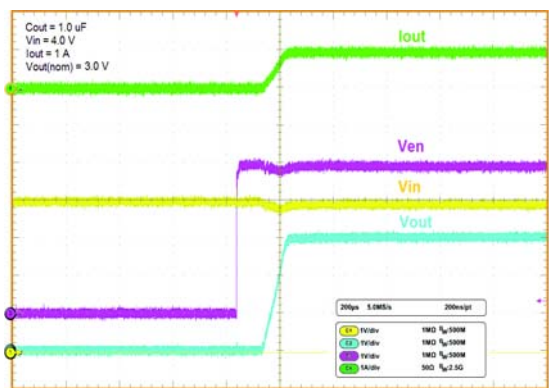

Figure 36. Turn-on by Enable Signal

NCP706

TYPICAL CHARACTERISTICS

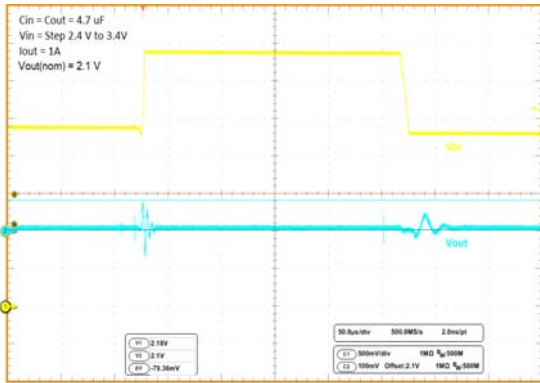

Figure 37. Line Transient Response

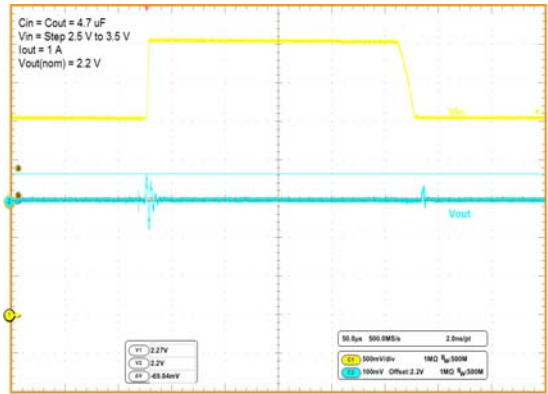

Figure 38. Line Transient Response

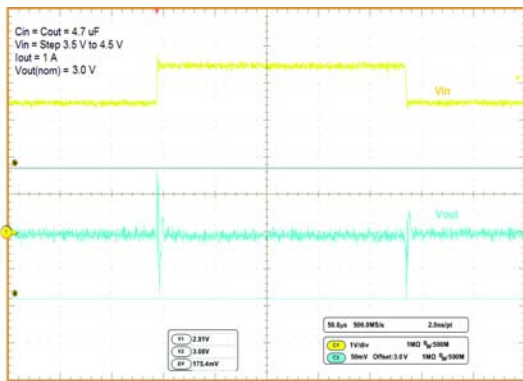

Figure 39. Line Transient Response

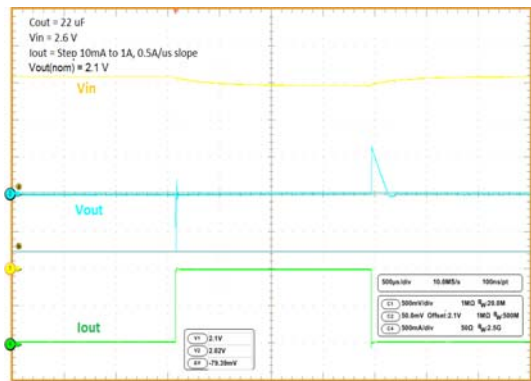

Figure 40. Load Transient Response

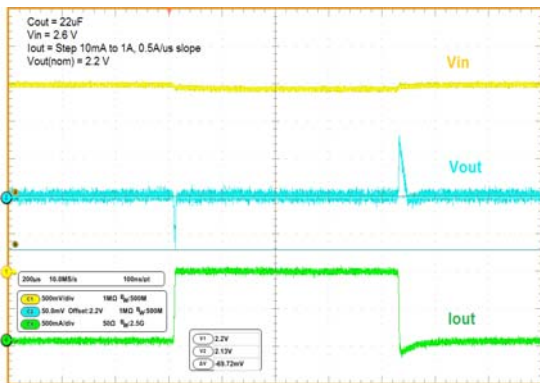

Figure 41. Load Transient Response

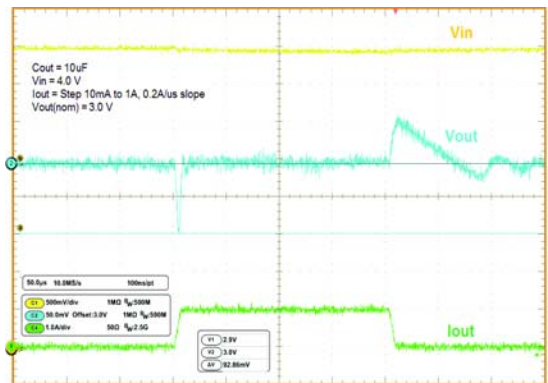

Figure 42. Load Transient Response

NCP706

APPLICATIONS INFORMATION

Input Decoupling (C_{in})

A 4.7 µF capacitor either ceramic or tantalum is recommended and should be connected as close as possible to the pins of NCP706 device. Higher values and lower ESR will improve the overall line transient response.

Output Decoupling (C_{out})

The minimum decoupling value for NCP706MX21TAG and NCP706MX22TAG devices is 4.7 µF and can be augmented to fulfill stringent load transient requirements. The minimum decoupling value for NCP706MX295TAG and NCP706MX706300TAG devices is 1 µF. The regulator accepts ceramic chip capacitors MLCC. If a tantalum capacitor is used, and its ESR is large, the loop oscillation may result. Larger values improve noise rejection and PSRR.

Enable Operation

The enable pin EN will turn on or off the regulator. These limits of threshold are covered in the electrical specification section of this data sheet. If the enable is not used then the pin should be connected to V_{IN}.

Hints

Please be sure the V_{in} and GND lines are sufficiently wide. If their impedance is high, noise pickup or unstable operation may result.

Set external components, especially the output capacitor, as close as possible to the circuit.

The sense pin SNS trace is recommended to be kept as far from noisy power traces as possible and as close to load as possible.

Thermal

As power across the NCP706 increases, it might become necessary to provide some thermal relief. The maximum power dissipation supported by the device is dependent upon board design and layout. Mounting pad configuration on the PCB, the board material, and also the ambient temperature affect the rate of temperature rise for the part. This is stating that when the NCP706 has good thermal conductivity through the PCB, the junction temperature will be relatively low with high power dissipation.

The power dissipation across the device can be roughly represented by the equation:

$$P_D = (V_{IN} - V_{OUT}) * I_{OUT} \text{ [W]} \quad (\text{eq. 1})$$

The maximum power dissipation depends on the thermal resistance of the case and circuit board, the temperature differential between the junction and ambient, PCB orientation and the rate of air flow.

The maximum allowable power dissipation can be calculated using the following equation:

$$P_{MAX} = (T_J - T_A) / \theta_{JA} \text{ [W]} \quad (\text{eq. 2})$$

Where (T_J - T_A) is the temperature differential between the junction and the surrounding environment and θ_{JA} is the thermal resistance from the junction to the ambient.

Connecting the exposed pad and non connected pin 3 to a large ground pad or plane helps to conduct away heat and improves thermal relief.

ORDERING INFORMATION

| Device | Nominal Output Voltage | Marking | Package | Shipping† |
|--------------------------------|------------------------|---------|-----------------|-------------------------------------|
| NCP706MX21TAG | 2.1 V | QM | XDFN8 (Pb-Free) | 3000 / Tape & Reel |
| NCP706MX22TAG | 2.2 V | QR | XDFN8 (Pb-Free) | 3000 / Tape & Reel |
| NCP706MX295TAG | 2.95 V | A2 | XDFN8 (Pb-Free) | 3000 / Tape & Reel |
| NCP706MX300TAG | 3.0 V | A3 | XDFN8 (Pb-Free) | 3000 / Tape & Reel |
| NCP706MX33TAG (In Development) | 3.3 V | Q3 | XDFN8 (Pb-Free) | 3000 / Tape & Reel (Available Soon) |

†For information on tape and reel specifications, including part orientation and tape sizes, please refer to our Tape and Reel Packaging Specifications Brochure, BRD8011/D.

MECHANICAL CASE OUTLINE

PACKAGE DIMENSIONS

ON Semiconductor®



SCALE 4:1

XDFN8 1.6x1.2, 0.4P CASE 711AS ISSUE D

DATE 08 DEC 2015

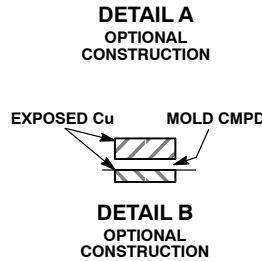
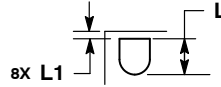
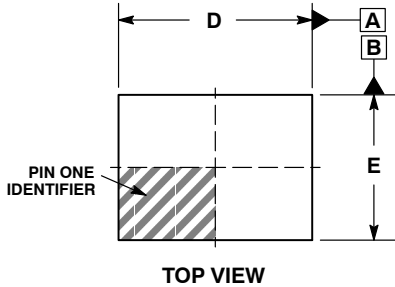

NOTES:

1. DIMENSIONING AND TOLERANCING PER ASME Y14.5M, 1994.
2. CONTROLLING DIMENSION: MILLIMETERS.
3. COPLANARITY APPLIES TO THE EXPOSED PAD AS WELL AS THE TERMINALS.

| DIM | MILLIMETERS | | |
|-----|-------------|-------|-------|
| | MIN | NOM | MAX |
| A | 0.300 | 0.375 | 0.450 |
| A1 | 0.000 | 0.025 | 0.050 |
| b | 0.130 | 0.180 | 0.230 |
| D | 1.500 | 1.600 | 1.700 |
| D2 | 1.200 | 1.300 | 1.400 |
| E | 1.100 | 1.200 | 1.300 |
| E2 | 0.200 | 0.300 | 0.400 |
| e | 0.40 BSC | | |
| L | 0.150 | 0.200 | 0.250 |
| L1 | 0.000 | 0.050 | 0.100 |

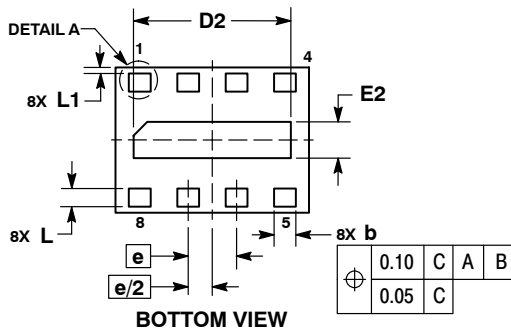
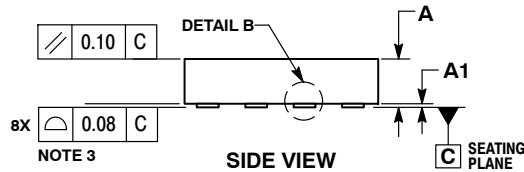

GENERIC MARKING DIAGRAM*

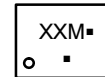

- XX = Specific Device Code
- M = Date Code
- = Pb-Free Package

(Note: Microdot may be in either location)
*This information is generic. Please refer to device data sheet for actual part marking. Pb-Free indicator, "G" or microdot "▪", may or may not be present.

RECOMMENDED MOUNTING FOOTPRINT*

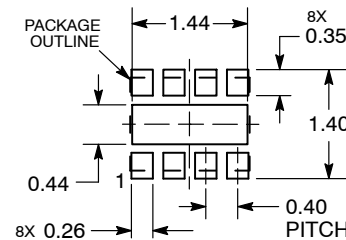

DIMENSIONS: MILLIMETERS

*For additional information on our Pb-Free strategy and soldering details, please download the ON Semiconductor Soldering and Mounting Techniques Reference Manual, SOLDERRM/D.

| | | |
|-------------------------|-----------------------------|--|
| DOCUMENT NUMBER: | 98AON87768E | Electronic versions are uncontrolled except when accessed directly from the Document Repository. Printed versions are uncontrolled except when stamped "CONTROLLED COPY" in red. |
| DESCRIPTION: | XDFN8, 1.6X1.2, 0.4P | PAGE 1 OF 1 |

ON Semiconductor and are trademarks of Semiconductor Components Industries, LLC dba ON Semiconductor or its subsidiaries in the United States and/or other countries. ON Semiconductor reserves the right to make changes without further notice to any products herein. ON Semiconductor makes no warranty, representation or guarantee regarding the suitability of its products for any particular purpose, nor does ON Semiconductor assume any liability arising out of the application or use of any product or circuit, and specifically disclaims any and all liability, including without limitation special, consequential or incidental damages. ON Semiconductor does not convey any license under its patent rights nor the rights of others.

onsemi, **Onsemi**, and other names, marks, and brands are registered and/or common law trademarks of Semiconductor Components Industries, LLC dba "**onsemi**" or its affiliates and/or subsidiaries in the United States and/or other countries. **onsemi** owns the rights to a number of patents, trademarks, copyrights, trade secrets, and other intellectual property. A listing of **onsemi**'s product/patent coverage may be accessed at www.onsemi.com/site/pdf/Patent-Marking.pdf. **onsemi** reserves the right to make changes at any time to any products or information herein, without notice. The information herein is provided "as-is" and **onsemi** makes no warranty, representation or guarantee regarding the accuracy of the information, product features, availability, functionality, or suitability of its products for any particular purpose, nor does **onsemi** assume any liability arising out of the application or use of any product or circuit, and specifically disclaims any and all liability, including without limitation special, consequential or incidental damages. Buyer is responsible for its products and applications using **onsemi** products, including compliance with all laws, regulations and safety requirements or standards, regardless of any support or applications information provided by **onsemi**. "Typical" parameters which may be provided in **onsemi** data sheets and/or specifications can and do vary in different applications and actual performance may vary over time. All operating parameters, including "Typicals" must be validated for each customer application by customer's technical experts. **onsemi** does not convey any license under any of its intellectual property rights nor the rights of others. **onsemi** products are not designed, intended, or authorized for use as a critical component in life support systems or any FDA Class 3 medical devices or medical devices with a same or similar classification in a foreign jurisdiction or any devices intended for implantation in the human body. Should Buyer purchase or use **onsemi** products for any such unintended or unauthorized application, Buyer shall indemnify and hold **onsemi** and its officers, employees, subsidiaries, affiliates, and distributors harmless against all claims, costs, damages, and expenses, and reasonable attorney fees arising out of, directly or indirectly, any claim of personal injury or death associated with such unintended or unauthorized use, even if such claim alleges that **onsemi** was negligent regarding the design or manufacture of the part. **onsemi** is an Equal Opportunity/Affirmative Action Employer. This literature is subject to all applicable copyright laws and is not for resale in any manner.

ADDITIONAL INFORMATION

TECHNICAL PUBLICATIONS:

Technical Library: www.onsemi.com/design/resources/technical-documentation
onsemi Website: www.onsemi.com

ONLINE SUPPORT: www.onsemi.com/support

For additional information, please contact your local Sales Representative at www.onsemi.com/support/sales



Looking for pricing, stock, or lifecycle information?

Click below to explore more details on WIN SOURCE:

 [View NCP706MX21TAG](#) on WIN SOURCE

 [ON Semiconductor](#) Information

Optimize Your Supply Chain with WIN SOURCE Solutions

-  Global Sourcing Solution
-  Obsolete Management
-  Cost Control Management
-  Shortage Management
-  Alternative Solution
-  Excess Inventory Management